

# Biotage<sup>®</sup> VacMaster<sup>™</sup> 10 & 20 Sample Processing Manifold

User Manual



# Biotage® VacMaster™ 10 & 20 Sample Processing Manifold User Manual

## CONTENTS

|           |   |
|-----------|---|
| <b>1</b>  | <b>Important Information</b>  |
| 1         | Safe Working Practices  |
| <b>1</b>  | <b>Warranty and Liability</b>                                       |
| <b>2</b>  | <b>Introduction</b>   |
| 2         | About the Biotage® VacMaster™<br>Sample Processing Manifold         |
| 2         | Specifications  |
| <b>5</b>  | <b>Principle of Operation</b>                                       |
| 5         | Features  |
| <b>7</b>  | <b>Installation</b>   |
| 7         | Unpacking   |
| 7         | What You Will Need  |
| 8         | Installing the Needles  |
| 8         | Installing Collection Tubes   |
| 8         | Replacing Collection Tube Racks                                     |
| 8         | Adjusting the Collection Tube Rack                                  |
| <b>9</b>  | <b>Routine Operation</b>  |
| 9         | Using the Vacuum Control and Gauge                                  |
| 9         | Using the Waste Outlet Fitting                                      |
| 9         | Using Biotage® VacMaster™ with<br>Biological or Hazardous Materials |
| <b>10</b> | <b>Maintenance and Troubleshooting</b>                              |
| 10        | Maintenance   |
| 10        | Troubleshooting   |
| <b>11</b> | <b>Ordering Information</b>   |

# Important Information

In the interest of safety, the Biotage® VacMaster™ Sample Processing Manifold is thoroughly tested at high vacuum. This involves a series of cycles from low vacuum to nominal full vacuum followed by a final 'hold' phase at normal full vacuum. As such, we have the utmost confidence in the quality of this product.

However, as with all glass vessels under vacuum, there is a risk of implosion particularly if the unit is subject to any sharp knocks or scratches. With this in mind, please follow the safe working practices detailed below.

## Safe Working Practices

1. Do not use VacMaster at a vacuum greater than minus 20" Hg (-0.68 bar).
2. Always wear eye protection when using VacMaster under vacuum. As with all glass laboratory equipment operated under vacuum, we consider it prudent to operate the unit behind a suitable safety screen.
3. Avoid knocking or scratching VacMaster with any sharp or heavy object.
4. If the VacMaster glass tank is dropped, scratched or damaged in any way, we strongly recommend that it should be replaced.

# Warranty and Liability

See the "Biotage Terms & Conditions of Sale" document at [www.biotage.com](http://www.biotage.com).

# Introduction

## About the Biotage® VacMaster™ Sample Processing Manifold

Biotage® VacMaster™ is a state-of-the-art sample processing manifold. It incorporates innovative design features that make simultaneously processing of multiple samples easier than ever before. For scientists working with biological fluids, these features and operating procedures provide a safe system. VacMaster has 10 or 20 ports with disposable stainless steel needles that accept any male Luer sample preparation product. A PTFE needle or combined needle stopcock are available for inert sample delivery. The design features, materials of construction, and full range of accessories mean that VacMaster meets the needs of scientists involved in multiple sample processing.

### Included Components

- » A glass tank fitted with a rotating vacuum outlet valve with a drain tube.
- » A PTFE lid fitted with 10 or 20 stainless steel needle retainers.
- » A vacuum gauge and controller with coarse and fine adjustments mounted to the lid.
- » A complete collection tube rack fitted with 10, 12, 16, 25, or 27 mm plates (VacMaster 10) or 10, 12, 16, or 20 mm plates (VacMaster 20).
- » A package of 10 or 20 stainless steel needles with port sealing plugs.

### Optional Accessories

- » Replacement racks for 12 or 16 mm collection tubes (VacMaster 10).
- » Additional racks for 10, 12, or 16 mm collection tubes (VacMaster 20).
- » Replacement glass tank with vacuum outlet fittings (VacMaster 10 or VacMaster 20).
- » PTFE T-type valve for switching between two tanks.
- » PTFE stopcocks.
- » PTFE needles or combination needle stopcocks.
- » Combined PTFE needle stopcock for use under positive pressure conditions.
- » VacMaster LVE accessories for the extraction of multiple large volume water samples using both polypropylene and glass SPE columns.

## Specifications

### Materials

|                                |  |
|--------------------------------|--|
| <b>Lid</b>                     | PTFE   |
| <b>Rack</b>                    | Ultra high molecular weight polyethylene (UHMW PE), polypropylene (legs) |
| <b>Waste Outlet</b>            | PTFE   |
| <b>Vacuum Gauge</b>            | Various  |
| <b>Controller Arm Assembly</b> | Delrin   |
| <b>Tank</b>                    | Glass  |
| <b>Rack Plates</b>             | Ultra high molecular weight polyethylene (UHMW PE)                       |
| <b>Needle</b>                  | 316 stainless steel  |
| <b>Needle Retainer</b>         | PTFE   |
| <b>Vacuum Release Valve</b>    | Brass  |

### Details

|                               |  |
|-------------------------------|--|
| <b>Maximum Applied Vacuum</b> | Minus 20" Hg (-0.68 bar)                 |
| <b>Sampling Ports</b>         | 10 on VacMaster 10<br>20 on VacMaster 20 |

### Dimensions – Biotage® VacMaster™ 10

See page 3.



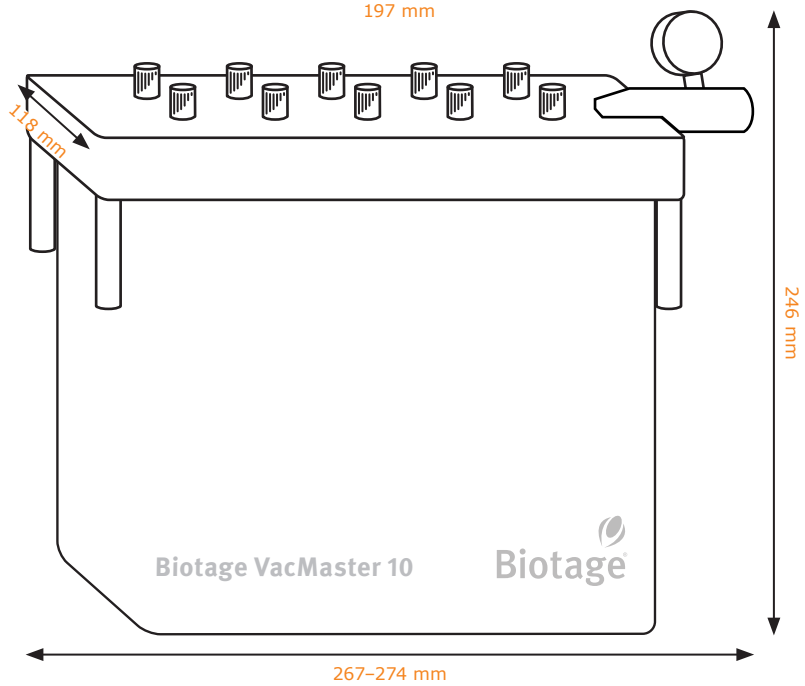
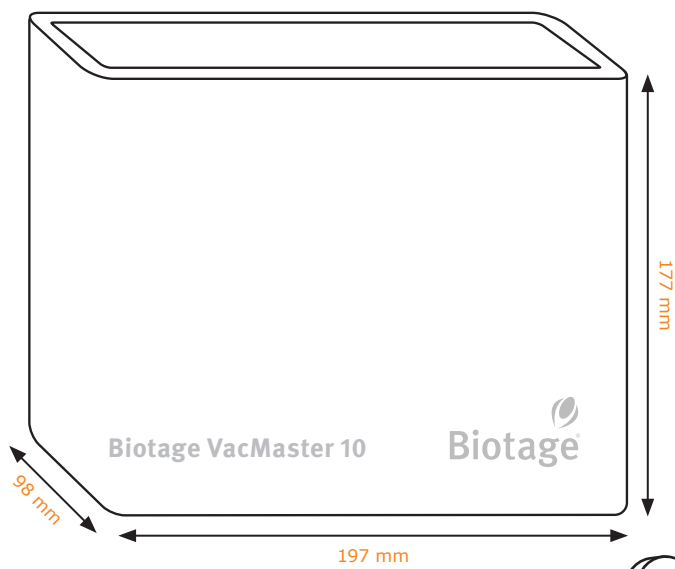
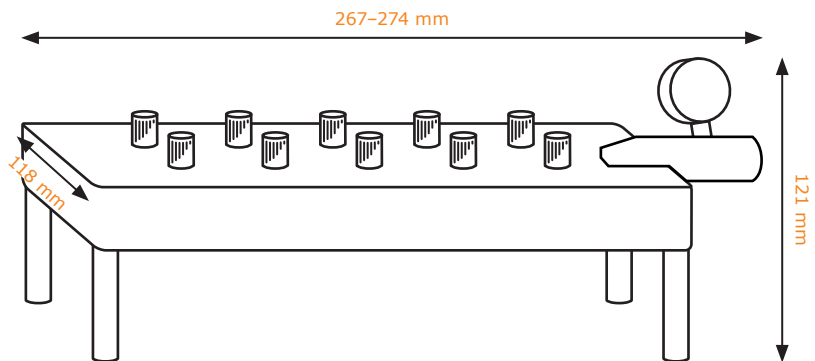

### Dimensions – Biotage® VacMaster™ 20

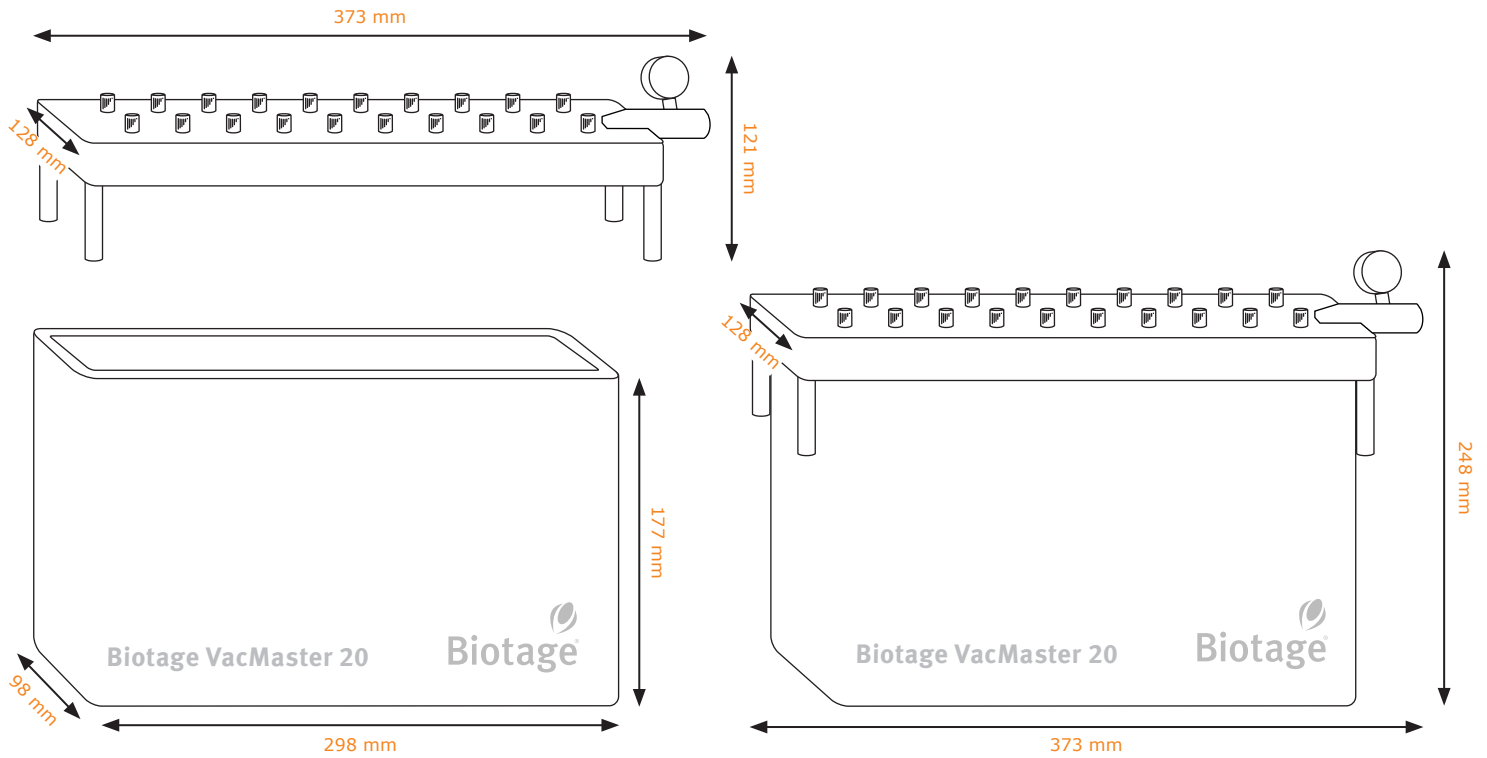

# Principle of Operation

VacMaster applies a vacuum to the outlet of a solid phase extraction column (or similar) to assist in the extraction of aqueous or viscous samples or to simultaneously process multiple samples. VacMaster uses a vacuum controller with fine and coarse adjustment controls and a vacuum gauge to set and monitor the vacuum applied to the glass tank. The lid seals to the tank with a gasket assisted by the vacuum. Applying vacuum to the tank and opening the stopcock will draw the sample or eluent through the SPE column or other sample preparation product. The sample or eluent collects in test tubes or vials held in the rack below the delivery tips. Alternatively, using VacMaster without a rack, the solvent can collect in the bottom of the tank. The glass tank has a vacuum outlet fitting that can be oriented two ways. When the fitting is turned up, solution will remain in the tank below the level of the outlet fitting. When the fitting is swiveled down, waste fluids in the tank flow into a collection trap for proper disposal.

## Features

### **Easy to Access Stopcocks and Room for Large Volume Columns**

VacMaster manifolds are available with 10 or 20 positions. With generous spacing between positions, you can use every position every time, even with stopcocks and large volume columns. VacMaster 10 can accommodate up to 10 x 70 mL columns and VacMaster 20 up to 20 x 25 mL columns.

### **A Rack System That Is Easy to Adjust to a Variety of Collection Tubes**

The continuously adjustable rack system uses unique threaded rods to secure the rack plates where you need them. Rack plates are available for 10, 12, and 16 mm diameter tubes as standard (plus 25 and 27 mm for VacMaster 10 and 20 mm for VacMaster 20). Replacement racks are available. The maximum tube diameter possible with VacMaster 10 is 27 mm (accommodates scintillation vials) and 23 mm with VacMaster 20. Custom racks are available, contact your Biotage representative for details.

### **Needles with Easy to Use Stopcocks That Do Not Contaminate Samples**

The one piece needle design with a straight through flow path will not trap samples or eluents, which could contaminate the subsequent sample. The disposable needles consist of 316 stainless steel and will not corrode like stainless-steel-clad-copper needles. PTFE retainers hold the stainless steel needles in place, so they are easy to remove and replace. The inert construction of the PTFE needle or combination needle stopcock eliminates plasticizer contamination and ensures smooth stopcock operation. Tapered PTFE tips eliminate overspray and direct the sample and eluent into the collection tube. All of the needles are securely threaded into the manifold top so they will not pull out when removing the SPE column.

### **Materials of Construction That Will Not Contaminate Samples**

VacMaster is manufactured from high quality materials that will not contaminate the samples being processed. The materials include glass, PTFE, UHMW polyethylene, polypropylene, and 316 stainless steel. The thick walled glass tank provides a clear view of the extraction process.

### **Vacuum Controllers That Will Not Become Contaminated or Corroded**

The precision made vacuum controller with gauge provides excellent sample flow control. The vacuum regulator, placed on the lid, is easy to see and control. Column eluents will not pass by and contaminate or corrode the regulator.

### **Safe, Easy Way to Handle Biological and Hazardous Sample Matrices**

With the lid-mounted vacuum controller, it is possible to use one tank to process the samples and dedicate a second low cost tank for the elution step. Thus, the second tank can remain uncontaminated. Additionally, the vacuum outlet fitting on the glass tank can be oriented two ways. Turn the fitting up to close the outlet and add the appropriate sterilization solution to the tank to neutralize the collected biological solutions. Swivel the fitting down to direct the waste fluids out of the tank into a side arm collection flask for proper disposal.

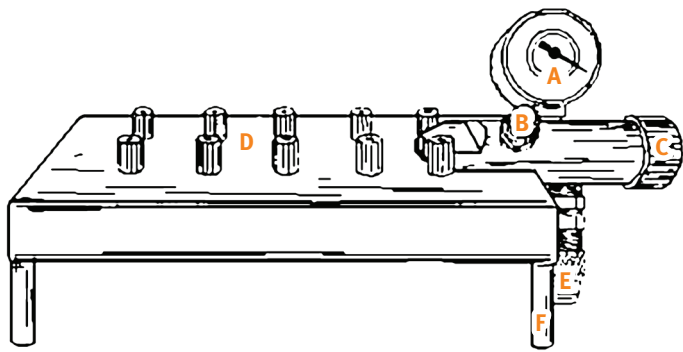

**Figure 1.** Lid.

- A. Vacuum gauge mounted on controller arm assembly.
- B. Fine control valve.
- C. Coarse vacuum control valve (open or closed).
- D. PTFE lid. For replacement lid complete with all fittings, order P/N 121-1045 (VacMaster 10) or P/N 121-2075 (VacMaster 20).
- E. Vacuum relief valve.
- F. Lid leg.
- G. Air flow tube (not shown, located under lid).

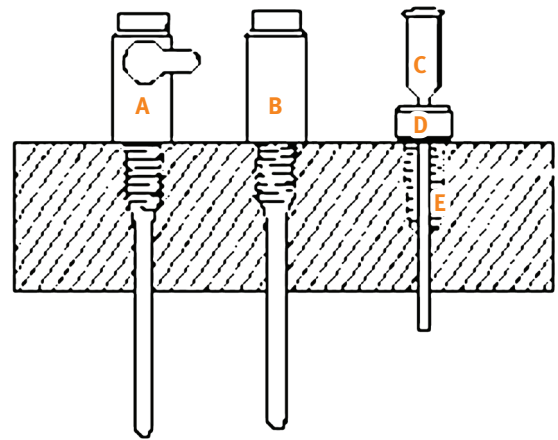

**Figure 3.** Needle detail.

- A. PTFE stopcock needle unit (P/N 121-0001).
- B. PTFE needle unit (P/N 121-0002).
- C. Stainless steel needle (P/N 121-0003).
- D. Stainless steel needle retainer (P/N 121-0004).
- E. Threaded needle ports.

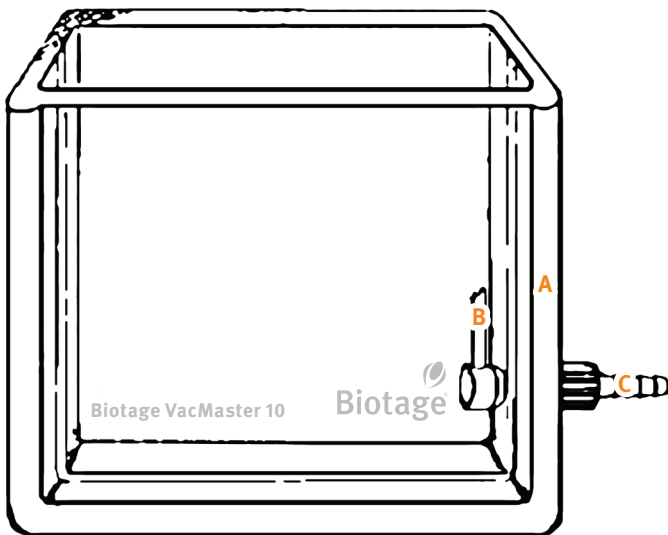

**Figure 2.** Glass tank. For replacement tank complete with fittings, order P/N 121-1039 (VacMaster 10) or P/N 121-2068 (VacMaster 20).

- A. Thick walled glass tank.
- B. VacMaster waste outlet (inner).
- C. VacMaster waste outlet (outer).

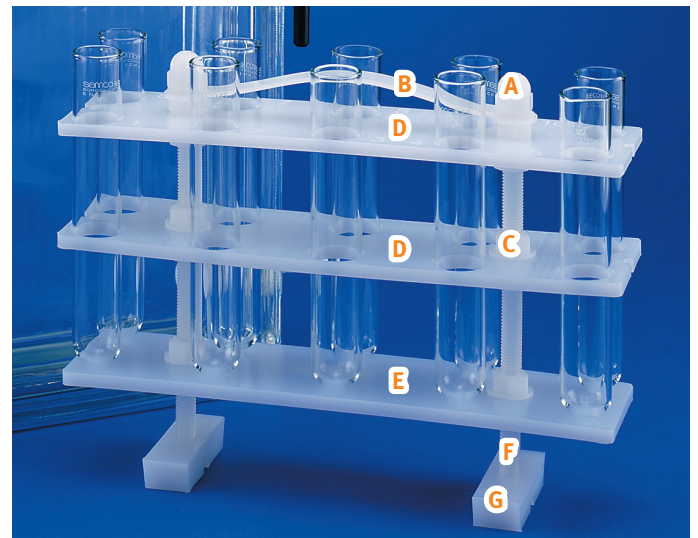

**Figure 4.** Collection tube rack.

- A. Rack dome nut.
- B. Rack handle.
- C. Rack nut washer.
- D. Top/middle plate.
- E. Lower plate.
- F. Rack leg.
- G. Rack foot.



# Installation



## Unpacking

VacuMaster manifolds are shipped with all accessories in one box. Before using VacuMaster, unpack all the components carefully. Do not discard any packing material until you have checked the VacuMaster unit and the accessories. We suggest that you store the packing materials to have them available for storage or future shipments.

If you find any damage to the unit or the box, contact the shipping company that delivered your VacuMaster and file a claim. Please contact Biotage or your local distributor for assistance in repairing or replacing the product.

## What You Will Need

In addition to the VacuMaster unit and the accessories, you will need the following to use VacuMaster.

### Vacuum Source

#### » Vacuum control unit with integral vacuum generator (P/N 121-9602)

Converts standard laboratory compressed air supply to vacuum that is ample for processing samples on VacuMaster. The unit has a small footprint, and has low noise emissions compared to a standard vacuum pump. Connect the vacuum source to the vacuum outlet fitting on the side of the glass tank using vacuum tubing. Place a trap in the vacuum line to collect any liquid for proper disposal.

#### » Vacuum pump

We recommend that you use a vacuum pump that is oil free and generates no more than minus 20" Hg (-0.68 bar). Connect the vacuum source to the vacuum outlet fitting on the side of the glass tank using vacuum tubing. Place a trap in the vacuum line to collect any liquid for proper disposal.

Suitable vacuum sources, tubing, and a 1- or 10-liter polypropylene trap are available from Biotage.

## Sample Preparation Columns (for Example SPE, SLE, Filtration)

If you are uncertain as to which column to use, please contact Biotage for technical advice or assistance.

### Collection Tubes

Select collection tubes suitable for your rack and your intended use. Racks are available to accommodate 10, 12, or 16 mm tubes (and 25 or 27 mm for VacMaster 10 and 20 mm for VacMaster 20).

## Installing the Needles

The stainless steel needle retainers are securely threaded into the lid when VacMaster is assembled, and fitted with stainless steel needles.

PTFE needles or combination needle stopcocks can be used in place of the stainless steel needles. To install these needles, remove the stainless steel needle retainers by rotating them counterclockwise until they are free from the lid. Place the new PTFE needle or combination needle stopcock into position and turn clockwise until firmly seated against the lid. Use caution to thread the needle correctly. Mistthreading or overtightening the needles or needle retainers could damage the threads on the needles, retainers, or lid ports.

## Installing Collection Tubes

The collection tube rack comes pre-assembled and should be ready to use with most collection tubes. Simply place the collection tube in the rack under each position you intend to use. If your tubes do not fit in the rack or are not securely held by the collection tube rack, you may need to replace the rack plates or adjust the rack.

## Replacing Collection Tube Racks

VacMaster is shipped with tube racks for 10, 12, or 16 mm tubes (and 25 or 27 mm for VacMaster 10 and 20 mm for VacMaster 20), specified with each order. Compare the part number of your VacMaster with the ordering information on page 11 to determine which rack you have. Alternatively, measure the diameter of the opening in the top collection tube rack plate. Additional 10, 12, or 16 mm collection tube racks or rack plates are available. Custom racks that meet other collection tube requirements can be purchased. See "Ordering Information" on page 11 for part numbers and ordering information.

## Adjusting the Collection Tube Rack

If your collection tubes are not securely held by the collection rack, the rack may need adjustment. Each plate is held in place by nut washers positioned above and below the plate. When adjusting the rack, remember to keep all plates level. Refer to Figure 4 on page 6 while adjusting the rack.

### Bottom, Middle and Top Plates

#### Raise the Plate

Turn the nut washers above the plate counterclockwise until they reach the correct height. Turn the nut washers below the plate counterclockwise to raise the plate and tighten to secure in position.

#### Lower the Plate

Turn the nut washers below the plate clockwise until they reach the correct height. Turn the nut washers above the plate clockwise to lower the plate and tighten to secure in position.

### Handle and Dome Nuts

Securely tighten the dome nuts above the handle at the top of the rack legs at all times, to provide a secure handle for inserting or removing the rack from the tank.



# Routine Operation

## Using the Vacuum Control and Gauge

1. Place the SPE columns in the needle ports and add solvent or sample to the column reservoirs.
2. Open the stopcocks if they are being used.
3. Open both the coarse and fine vacuum control valves on the VacMaster lid. The coarse control valve is open when it is turned counter-clockwise. The fine control valve is open when turned fully counter-clockwise.
4. Apply vacuum to the VacMaster manifold from the vacuum source.
5. Close the coarse vacuum control valve by turning clockwise.
6. Adjust the vacuum by turning the fine control valve clockwise until the desired vacuum level and flow rate is obtained. Monitor the vacuum level on the vacuum gauge next to the control valves. A vacuum level of minus 3 to minus 5" of Hg is satisfactory for most applications. Establishing the vacuum level needed for optimum flow rates through the SPE column is an important part of every method development procedure.

### Warning

» Do not exceed minus 20" Hg (-0.68 bar) at any time. Vacuum levels above minus 20" Hg significantly increase the risk of implosion of the glass tank and serious personal harm.

7. If stopcocks are being used on the needle ports, the flow rate through each SPE column can be individually regulated by the stopcock position.
8. When the desired volume of solvent or sample is drawn through the tube:
  - a. Close each stopcock if they are being used.
  - b. Open the fine control valve by turning it counter-clockwise.
  - c. Open the coarse control valve by turning it counter-clockwise.
  - d. Turn off the vacuum source.
9. Continue the processing by adding the next solution to each SPE column reservoir. Repeat procedure from step 2 above.

## Using the Waste Outlet Fitting

The waste outlet fitting inside the glass tank of VacMaster can be oriented in two positions. When the fitting is positioned so the drain tube is up, liquid collects in the tank. When the fitting is turned down, any liquid that reaches the drain tube will be removed by vacuum from the tank through the outlet fitting.

A collection flask in the vacuum line is essential with the outlet fitting in this orientation to collect the evacuated liquid. Without a trap, the liquid would enter the vacuum pump and could damage the pump.

## Using Biotage® VacMaster™ with Biological or Hazardous Materials

When processing physiological fluids, tissues, environmental, or other hazardous samples, it is advantageous to purchase a second low cost tank to dedicate to the analyte elution step. This second tank can remain uncontaminated. A single vacuum source can be used by placing a PTFE T-valve in the vacuum line between the vacuum source and each manifold. The first tank can be used without a collection tube rack to collect the liquids exiting the columns during sample application and interference elution steps. By turning the waste outlet fitting up, liquids will remain in the tank. An appropriate sterilization solution (for example bleach) can be added to the tank to neutralize the collected biological liquids. Swivel the fitting down to direct the waste fluids out of the tank into a collection flask for proper disposal, or pour the waste fluids from the tank into the appropriate waste container.

After the samples have been loaded on the SPE columns and the interferences have been eluted, the VacMaster lid can be removed from the first tank and placed on the second tank. Then the samples can be eluted into collection tubes in the clean second tank.



# Maintenance and Troubleshooting

## Maintenance

If collection tubes are used routinely, VacMaster will require little or no cleaning. If the 'two tank' option is used for biological or hazardous samples, prompt removal and disposal of the collected liquids will reduce the amount of routine cleaning needed.

If the glass tank needs to be cleaned, please use water and mild laboratory detergents. Do not use scouring powders or pads, or anything else that would scratch or damage the tank. Any damage to the glass tank can severely increase the risk of implosion and serious personal harm.

## Troubleshooting

| Problem   | Cause   | Remedy  |
|---|---|---|
| No liquid flow through the column                                   | Column plugged  | Replace column<br>Filter samples to remove particulates. Use depth filter |
|   | Sample too viscous                                    | Dilute sample   |
| No vacuum   | No vacuum from source                                 | Check vacuum source   |
|   | Vacuum controller not adjusted properly               | Adjust fine and coarse control valves on VacMaster                        |
|   | Air entering through unused ports                     | Use port sealing plugs in ports without columns                           |
|   | Gasket on lid not sealing                             | Replace gasket  |
| Solvent not flowing into the collection tubes                       | Bent needles  | Replace or straighten needles   |
|   | Stopcock (if used) is closed                          | Open stopcock   |
| Liquid collecting in the bottom of the glass tank                   | Waste outlet fitting rotated up                       | Rotate fitting down and install drain tube                                |
| Tank lid will not close   | Collection tubes above tank rim                       | Lower bottom plate of collection plate                                    |
| Liquid collecting in vacuum   | Liquid is leaving tank                                | Rotate waste outlet fitting up  |
|   | No collection trap between manifold and vacuum source | Install collection trap between manifold and vacuum source                |
| Liquid in the collection tubes is disturbed when vacuum is released | Air is entering tank above tubes                      | Install air flow tube in right side of lid                                |

# Ordering Information

## Biotage® VacMaster® 10 for Processing Up to 10 Samples Simultaneously

| Part No. | Description                                       | Qty. |
|----------|---|------|
| 121-1010 | Complete with 10 mm diameter collection tube rack | 1    |
| 121-1012 | Complete with 12 mm diameter collection tube rack | 1    |
| 121-1016 | Complete with 16 mm diameter collection tube rack | 1    |
| 121-1027 | Complete with 27 mm diameter collection tube rack | 1    |

## Biotage® VacMaster® 20 for Processing Up to 20 Samples Simultaneously

| Part No. | Description                                       | Qty. |
|----------|---|------|
| 121-2010 | Complete with 10 mm diameter collection tube rack | 1    |
| 121-2012 | Complete with 12 mm diameter collection tube rack | 1    |
| 121-2016 | Complete with 16 mm diameter collection tube rack | 1    |

## Needles and Stopcocks for Biotage® VacMaster® 10 and 20

| Part No.   | Description                      | Qty. |
|------------|----------------------------------|------|
| 121-0001   | PTFE stopcock/needle unit        | 10   |
| 121-0002   | PTFE needle unit                 | 10   |
| 121-0003   | Stainless steel needles          | 20   |
| 121-0004   | Stainless steel needle retainer  | 10   |
| 121-0005   | Port sealing plugs               | 30   |
| 121-0009   | PTFE stopcock                    | 10   |
| 121-0009-S | PTFE stopcock- positive pressure | 10   |

## Large Volume Extraction Kits

Suitable for the simultaneous extraction of up to 10 large volume water samples using the VacMaster SPE manifold. Four options are available to cover the complete ISOLUTE product range. The kit includes 10 numbered PTFE tubes fitted to appropriate adaptors.

| Part No. | Description  | Qty. |
|----------|--|------|
| 121-2090 | VacMaster LVE kit for 1, 3 and 6 mL columns (A, B and C) | 1    |
| 121-2091 | VacMaster LVE kit for 15 and 25 mL columns (D and E)     | 1    |
| 121-2092 | VacMaster LVE kit for 70 mL columns (F)                  | 1    |
| 121-2094 | VacMaster LVE kit for ISOLUTE-XL columns                 | 1    |

## Components for Biotage® VacMaster® 10

| Part No. | Description                                | Qty. |
|----------|--|------|
| 121-1030 | Silicone lid gasket                        | 1    |
| 121-1039 | Spare glass tank with waste outlet fitting | 1    |
| 121-1045 | Complete lid (tested)                      | 1    |
| 121-1133 | VacMaster 10 rack 12 mm tubes              | 1    |
| 121-1134 | VacMaster 10 rack 16 mm tubes              | 1    |
| 121-1131 | VacMaster 10 rack 27 mm tubes              | 1    |

## Components for Biotage® VacMaster® 20

| Part No. | Description                                | Qty. |
|----------|--|------|
| 121-2059 | VacMaster 20 silicone lid gasket           | 1    |
| 121-2068 | Spare glass tank with waste outlet fitting | 1    |
| 121-2075 | Complete lid (tested)                      | 1    |
| 121-2161 | VacMaster 20 rack 10 mm tubes              | 1    |
| 121-2162 | VacMaster 20 rack 12 mm tubes              | 1    |
| 121-2163 | VacMaster 20 rack 16 mm tubes              | 1    |

## Vacuum Pump and Supplies

| Part No.    | Description  | Qty. |
|-------------|--|------|
| 121-9602    | Vacuum control unit with integral vacuum generator | 1    |
| 121-9241-EU | Vacuum pump 240V/50Hz N810.3 - 230/5 EURO version  | 1    |
| 121-9241-UK | Vacuum pump 240V/50Hz N810.3 - 230/5 UK version    | 1    |
| 121-0010    | PTFE T-valve                                       | 1    |
| 121-2095    | VacMaster trap kit, 1 L                            | 1    |
| 121-2195    | VacMaster trap kit, 10 L                           | 1    |





# Your Complete Partner for Effective Chemistry

Biotage is a worldwide supplier of instruments and accessories designed to facilitate the work of laboratory and process chemists. With our deep knowledge of the industry, academic contacts and in-house R&D teams, we can deliver the best solutions to your challenges. We take great pride in our flexibility and ability to meet our customer's individual needs. With strong foundations in both analytical, organic and process chemistry, we can offer the widest range of solutions available on the market.

## EUROPE

Main Office: +46 18 565900  
Toll Free: +800 18 565710  
Fax: +46 18 591922  
Order Tel: +46 18 565710  
Order Fax: +46 18 565705  
order@biotage.com  
Support Tel: +46 18 56 59 11  
Support Fax: +46 18 56 57 11  
eu-1-pointsupport@biotage.com

## NORTH & LATIN AMERICA

Main Office: +1 704 654 4900  
Toll Free: +1 800 446 4752  
Fax: +1 704 654 4917  
Order Tel: +1 704 654 4900  
Order Fax: +1 434 296 8217  
ordermailbox@biotage.com  
Support Tel: +1 800 446 4752  
Outside US: +1 704 654 4900  
us-1-pointsupport@biotage.com

## JAPAN

Tel: +81 3 5627 3123  
Fax: +81 3 5627 3121  
jp\_order@biotage.com  
jp-1-pointsupport@biotage.com

## CHINA

Tel: +86 21 68162810  
Fax: +86 21 68162829  
cn\_order@biotage.com  
cn-1-pointsupport@biotage.com

## KOREA

Tel: +82 31 706 8500  
Fax: +82 31 706 8510  
korea\_info@biotage.com  
kr-1-pointsupport@biotage.com

## INDIA

Tel: +91 22 4005 3712  
india@biotage.com

Distributors in other regions  
are listed on [www.biotage.com](http://www.biotage.com)

## Part Number: UI303-B

© 2020 Biotage. All rights reserved. No material may be reproduced or published without the written permission of Biotage. Information in this document is subject to change without notice and does not represent any commitment from Biotage. E&OE. A list of all trademarks owned by Biotage AB is available at [www.biotage.com/legal](http://www.biotage.com/legal). Other product and company names mentioned herein may be trademarks or registered trademarks and/or service marks of their respective owners, and are used only for explanation and to the owners' benefit, without intent to infringe.

