

HPLC columns

Thermo Scientific μPAC Flex iON Connect ESI-MS interface

Author

Thermo Fisher Scientific

Keywords

μPAC, nanoLC, low-flow LC, RPLC-MS/MS, nano electrospray ionization, nESI-MS, Nanospray Flex Series ion sources, electrospray stability

Introduction

The Thermo Scientific™ μPAC™ Flex iON Connect ESI-MS Interface is user-friendly and facilitates fast, reproducible, and low dispersion connection of Thermo Scientific™ μPAC™ columns to Thermo Scientific™ Nanospray Flex™ Series ion sources. In low-flow liquid chromatography (nano- and capillary-flow LC), the quality of post column connections is critical to preserve separation performance when analytes are transferred from the LC column to the ionization source of the mass spectrometer. As flow rates and column volumes are reduced, the effect of dead or unswept volumes in the flow path becomes significant, often reducing the separation resolution and decreasing the sensitivity of Liquid Chromatography-Mass Spectrometry (LC-MS) analyses.^{1,2}

Coupling a μPAC column to a μPAC Flex iON Connect ESI-MS source requires two liquid junctions between the column outlet and the emitter, with a minimum length of capillary in between: the first one (a liquid junction cross or liquid junction tee), distal from the column, to apply the ionization high voltage to the solvent, and a second one, at the column outlet, to shunt any leakage current to ground. Providing these two liquid junctions while maintaining the high separation performance of the μPAC, needs the highest care and attention. Figure 1 indicates the four different connections that are involved in this setup, each connection forming a risk of introducing a dead, unswept volume.

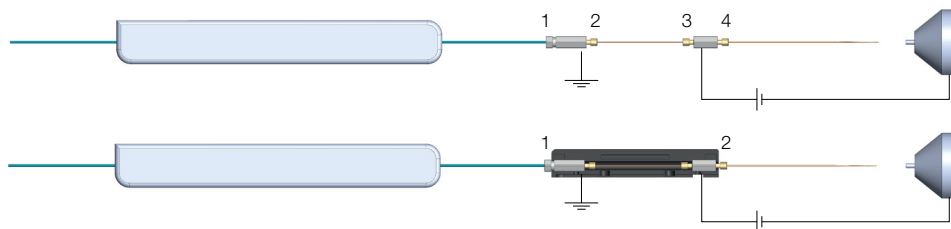

Figure 1. Schematic drawing showing the ESI-MS connection configuration. Top: Classic liquid junction connection, 4 connections have to be made. Bottom: μPAC Flex iON Connect ESI-MS interface, 2 connections have to be made.

Figure 2 illustrates the effect of unswept (dead) volumes in the flow path. By providing a column to MS interface that combines the two liquid junctions in a quality controlled and secured fashion, the number of post column user interventions is reduced, hereby increasing the robustness and reliability of the LC-MS coupling. In addition, both the grounding and high voltage-supply only need to be attached once at the initial installation of the docking part.

Installation and operation

The μ PAC Flex iON Connect ESI-MS interface can easily be mounted onto the Thermo Scientific™ DirectJunction™ adaptor of the Nanospray Flex Series ion source³ and consists of 2 separate units that have been fabricated by precise additive manufacturing of polyamide (nylon).

The docking unit can be slid onto the DirectJunction metal rod (the recessed front side fits perfectly over the PEEK front piece) and receives both the grounding (blue) and high voltage (red) cable. These cables only need to be connected upon initial installation and do not need to be removed when changing emitter tips from the spray unit. Spring loaded pogo pins in the docking unit are used to establish post column high voltage or ground contact to the conductive unions in the spray unit. The spray unit can be positioned onto the docking unit and is held in place by magnetic force. The detailed installation procedure can be found in the instructions for use.⁴

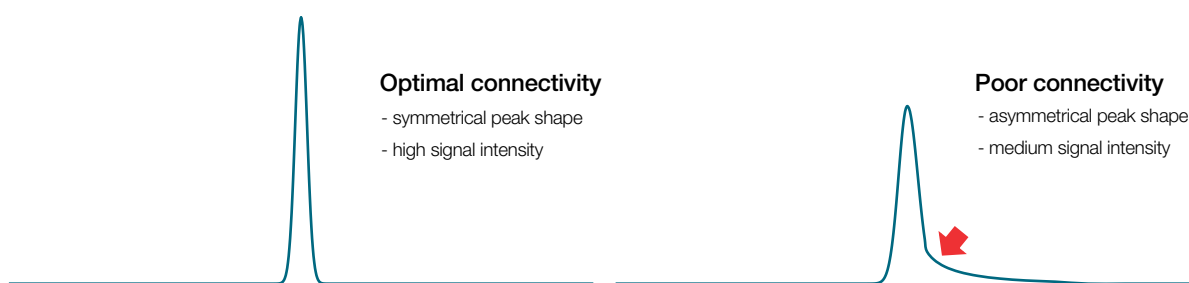

Figure 2. Effect of poor connectivity on observed peak shapes and signal intensity.

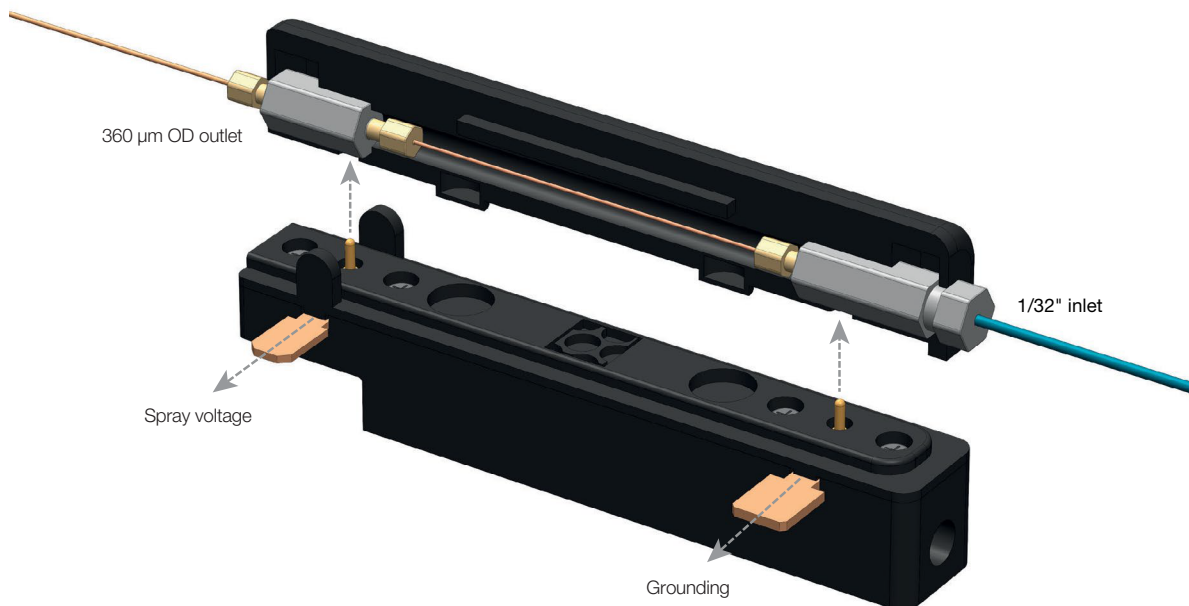
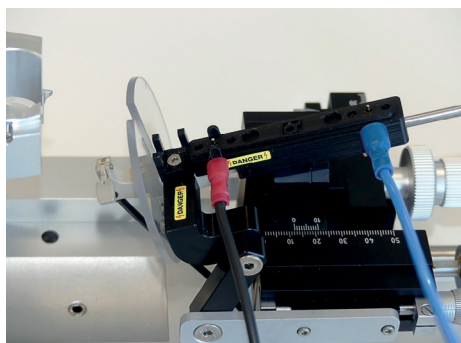
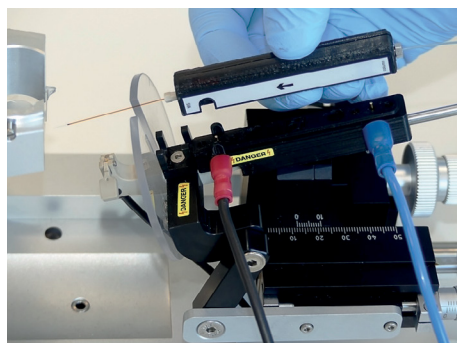

Figure 3. Schematic drawing showing a transverse section of the μ PAC Flex iON Connect ESI-MS Interface. The docking unit with connection points for high voltage and grounding cable (bottom) can be mounted onto the DirectJunction metal rod of the Nanospray Flex Series ion source. The spray unit consists of an assembly of 2 conductive reducing unions (50 μ m bore size) that have been interconnected through a piece of precision cut fused silica tubing (360 μ m OD–20 μ m ID). The inlet side where a grounded connection is provided has female 1/32" connectivity (compatible with the 1/32" outlet fittings of the μ PAC™ column). The outlet side where high voltage is applied is compatible with any 360 μ m OD emitter or tubing through a one-piece fingertight PEEK fitting.



Mounting the docking unit



Mounting the spray unit

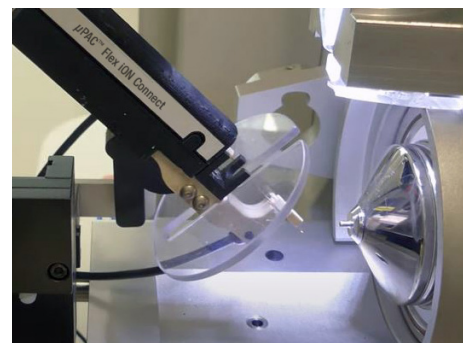

Adjusting emitter tip position

Figure 4. Installation of the μ PAC Flex iON Connect ESI-MS Interface on the Nanospray Flex Series ion source.

The μ PAC Flex iON Connect ESI-MS interface is designed to be used within the nanoLC flow range of μ PAC columns with a maximum flow rate of approximately 1500 nL/min. Selection of the appropriate emitter tip dimension is crucial to obtain optimal spray quality for a certain application. Analysis in the higher nanoLC flow rate range (500–1500 nL/min) will generally benefit from using emitter tips with larger tip sizes (20–30 μ m), whereas emitter tip sizes ≤ 10 μ m will give the best results for analysis in the lower nanoLC flow range (50–500 nL/min). While smaller tip sizes will generate a flow rate that is ideal for small sample volumes, the risk of clog formation increases and therefore also the risk of having to exchange emitter tips.

Before applying voltage on the μ PAC Flex iON connect ESI-MS interface, carefully inspect the electrical connections and make sure that all cables have been connected properly. The emitter tip should be plugged into the interface and fluid droplets should exit

without obstruction. To generate initial electrospray, a low spray voltage in the order of 1.0 to 1.5 kV is recommended. By slowly increasing the applied voltage in increments of 0.1 kV and monitoring changes in spray morphology and spray stability, optimal spray quality can be obtained for a combination of emitter tip ID and flow rate. The MS response that is obtained for a synthetic peptide (Thermo Scientific™ Pierce™ Retention Time Calibration Mixture—peptide 2—GISNEGQNASIK— m/z 613.32) is given for common nanoLC flow rates using 20 μ m ID emitter tips (FossilonTech, Spain). Optimal spray quality was obtained between 1.7 and 2.5 kV for LC flow rates of 250 and 500 nL/min. ESI spray current values observed at the start of the analysis (mobile phase composition A:100% H₂O+0.1% FA-B: 80% ACN+0.1% FA) can be used as a guide to verify that all electrical connections (including grounding point) have been made properly.

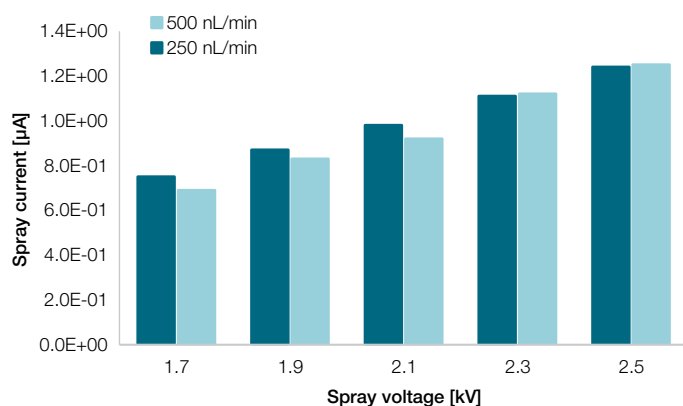
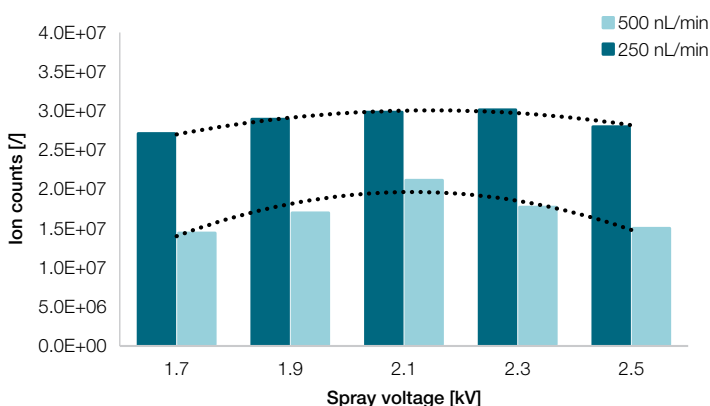

Figure 5. Left: ESI-MS response observed for a synthetic peptide as a function of voltage that was applied. Right: Respective spray current values observed at the start of the analysis (mobile phase composition 1% B).

Bottom-up proteomics evaluation

To evaluate the spray quality and stability within a typical bottom-up proteomics workflow, a series of reversed phase LC-MS analyses was performed on a 50 cm μ PAC column that was connected to a high resolution MS instrument through the μ PAC Flex iON Connect ESI-MS interface.⁵ By injecting a HeLa cell digest standard spiked with a synthetic peptide retention time

standard (Thermo Scientific™ Pierce™ Retention Time Calibration Standard), run-to-run repeatability in terms of retention time, peak area, peak width and number of identifications could be monitored over a period of 24 hours. Data consistency in terms of observed peak area for the 15 PRTC peptides (7.15% CV) demonstrates that secure spray stability is achieved with the μ PAC Flex iON Connect ESI-MS interface (Figure 6).

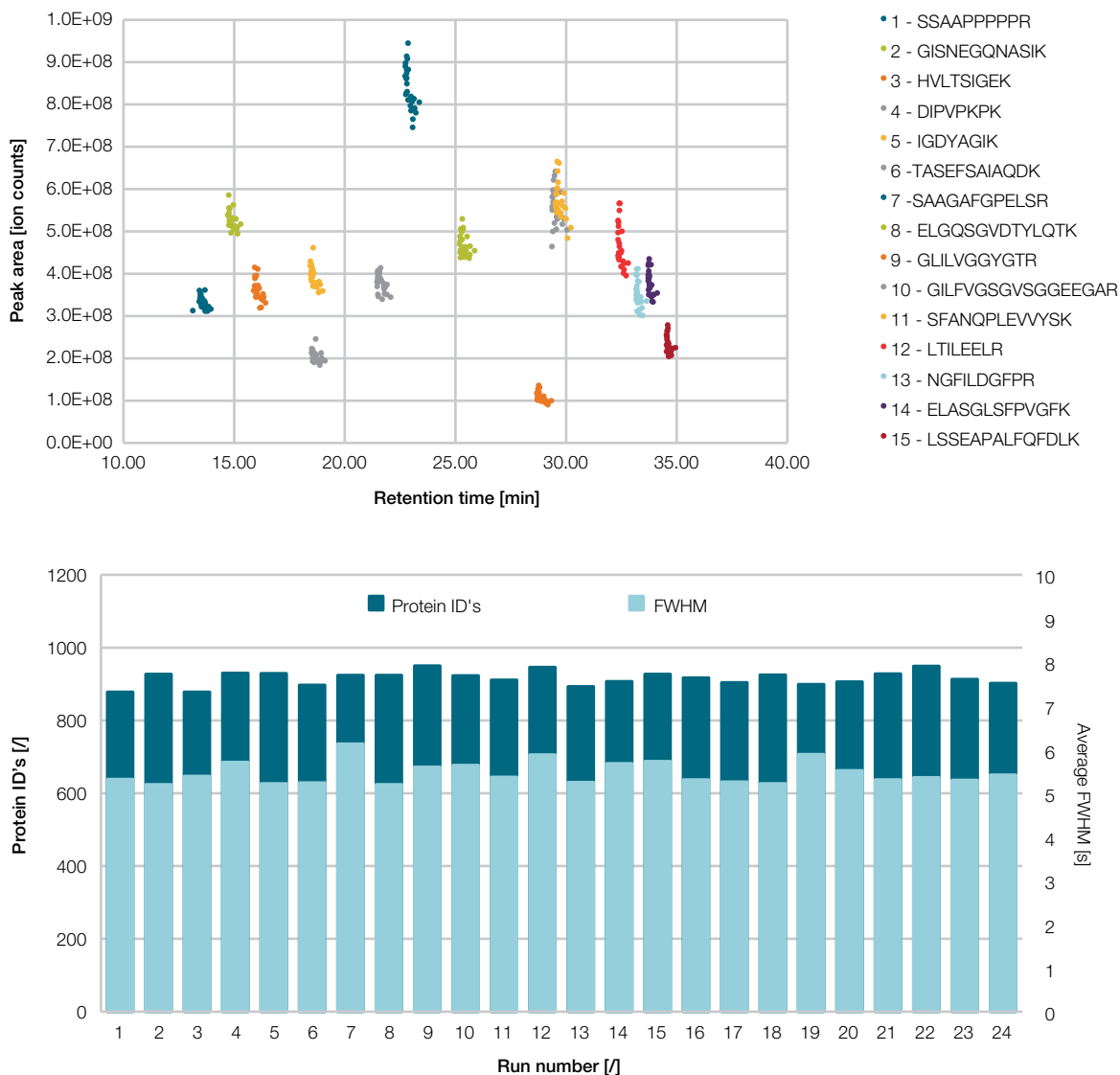

Figure 6. Top left: Peak area values that have been obtained for 15 Pierce retention time calibration peptides that have been spiked (100 fmol/ μ L) into a HeLa cell digest (100 ng/ μ L). Values are plotted as a function of the retention time and are shown for 24 consecutive analyses, total duration was 24h. Bottom: Number of protein groups that were identified in 24 consecutive 30 min gradient separations (60 min total run time) and average peptide FWHM value.

Operator skill level

Operator skill level is often crucial for the outcome of the nanoLC-MS analyses as poor quality connections may result in excessive peak tailing and concomitant loss of separation efficiency. To investigate the susceptibility of the μ PAC Flex iON Connect ESI-MS interface to human handling error, a series of experiments was conducted where operators with different LC-MS skill levels had to connect the interface to a μ PAC nanoLC column and a UV detector cell. Operator skill level ranged from no LC-MS experience at all to highly skilled (expert level). When

comparing the average peak width and the peak asymmetry that could be obtained by the different operators, little or no effect could be observed for the operators with skill levels Expert to Moderate. A slight increase in peak width and asymmetry were observed when operator skill level was further reduced to low and none. Comparing the overall operator variation to the variation that is produced by a single highly skilled operator (grey data series—Figure 7), it can be concluded that the μ PAC Flex iON Connect ESI-MS interface significantly increases the users' convenience for coupling μ PAC columns to an ESI source.

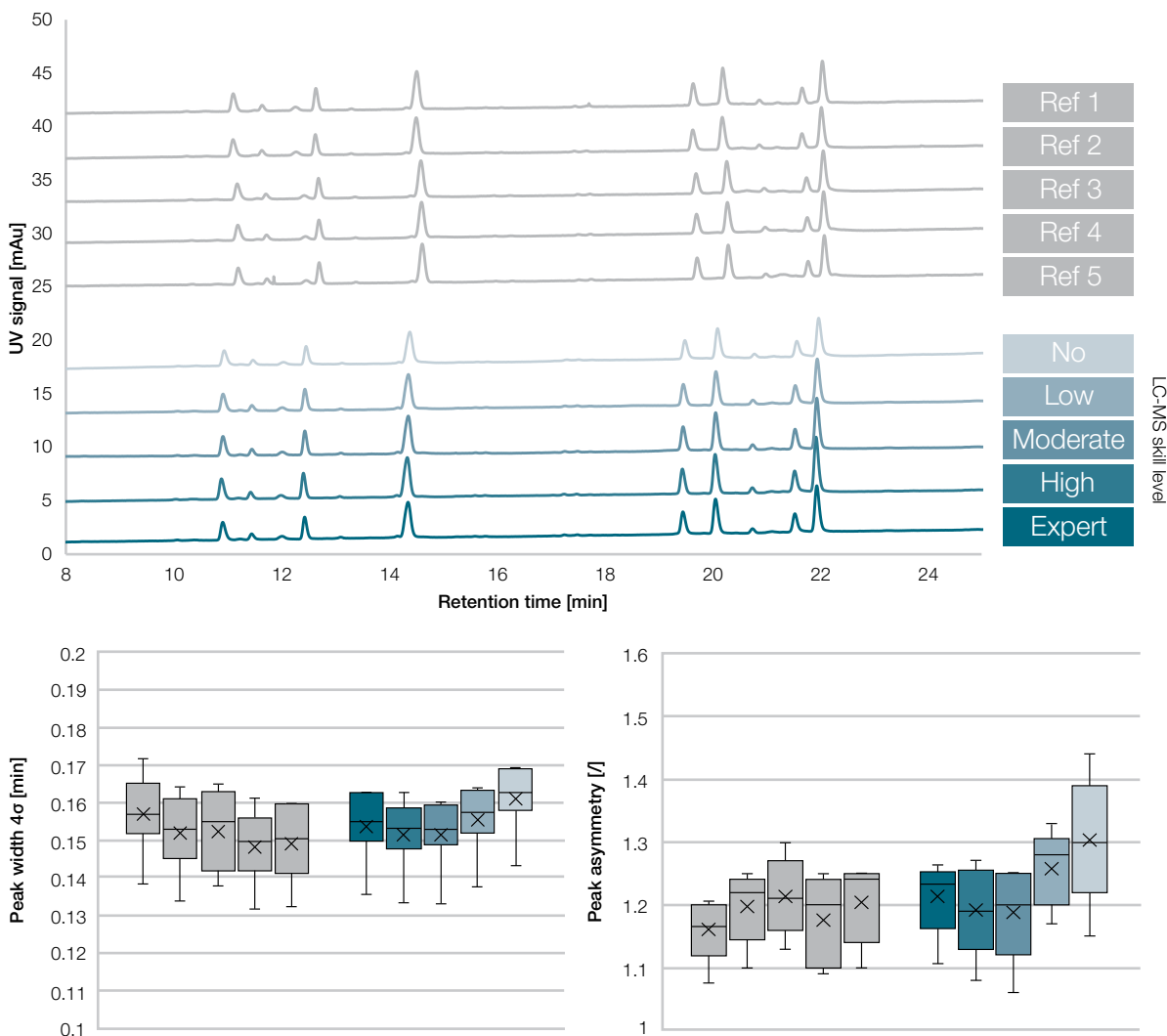

Figure 7. Top: UV chromatograms obtained for the separation of a cytochrome c tryptic digest, the result of 5 reference connections (grey—executed by the same operator) are compared to those obtained by operators with different LC-MS skill level (dark blue—expert skill level, light blue—no skill level). Bottom left: Average peak width values obtained in this experiment. Bottom right: average peak asymmetry values (EP) obtained in this experiment.

Key features of the μ PAC flex iON Connect ESI-MS interface

- Compatible with any type of 360 μ m OD electrospray emitters through one-piece fingertight fitting
- Preassembled liquid junction configuration to achieve the best performance
- Easy to implement on Thermo Scientific Nanospray Flex ion sources

References

1. Dolan, J.W., Upchurch, P., (1988) Troubleshooting LC Fittings, Part I, LC-GC Magazine 6, 788-790
2. Stoll, D.R., (2018) Fittings and connections for liquid chromatography – so many choices, LCGC North America 36, 304-311
3. Nanospray Flex™ Series - Ion Source - User Guide (Revision B), Thermo Fisher Scientific Manual 6005397127
4. PharmaFluidics μ PAC™ Flex iON Connect instructions for use
5. PharmaFluidics Technical note 5, Routine proteome analysis using 50 cm μ PAC™ columns

Learn more at thermofisher.com/lowflowHPLCcolumns

thermo scientific