

Dual EGC – a simple solution for carbohydrate analysis

Introduction

Thermo Scientific™ Dionex™ “Just Add Water” electrolytic eluent generation technology is an essential and powerful part of Reagent-Free™ Ion Chromatography (RFIC™) systems. This technology ensures excellent reproducibility and accuracy in eluent preparation.

Thermo Fisher Scientific now offers a new operating mode for RFIC systems, called Dual Eluent Generation Cartridge (Dual EGC) mode. This novel option can replace the manual preparation of the sodium hydroxide/sodium acetate (NaOH/NaOAc) eluent gradients required for analyzing complex carbohydrates.

Dual EGC mode is available on supported instruments, such as the Thermo Scientific™ Dionex™ ICS-6000 HPIC™ system and capillary systems, to support the analysis of complex carbohydrates. In Dual EGC mode, RFIC systems employ methanesulfonic acid (MSA) and potassium hydroxide (KOH) Thermo Scientific™ Dionex™ EGC Eluent Generator Cartridges, in series, to electrolytically generate potassium hydroxide/potassium methanesulfonate (KOH/KMSA) eluents. This operating mode is applicable to capillary (0.4 mm) and analytical (1.0 mm) column formats.



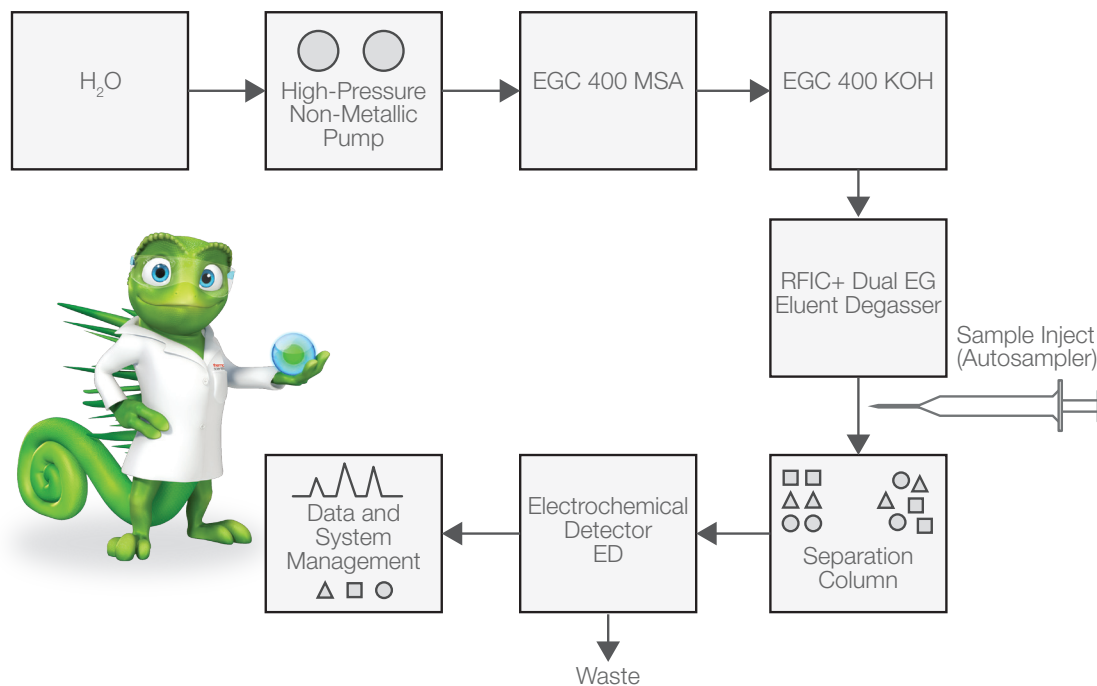

Figure 1. Ion chromatography system configuration under Dual EGC mode.

Why Dual EGC?

Dual EGC offers improved performance of Dionex RFIC systems for analyzing complex carbohydrates by:

- **Eliminating manual eluent preparations**

Reagent-free, electrolytic eluent generation eliminates the variation inherent to manual eluent preparation and related CO₂ intrusion. Automated eluent generation not only takes the manual labor out of ion chromatography, but it is also easy to adopt.

- **Improving IC reproducibility**

Automated eluent generation enables the generation of high-purity eluent at accurate concentrations, delivering consistent and reproducible retention time and baseline stability. These benefits lead to increased uptime and throughput.

- **Maximizing instrument uptime, minimizing maintenance**

When using these RFIC-enabled systems, the only routine reagent needed is deionized water. Consequently, the instrument pump seals and pistons come in contact only with deionized water, not acids or bases that can precipitate. This extends the lifetime of pump seals and pistons and significantly reduces overall pump maintenance, therefore, minimizing instrument downtime.

- **Offering eluent gradient capabilities**

This extension of RFIC technology enables the analyst to run gradient methods using an isocratic pump, while offering the analyst the flexibility to modify or change the eluent concentrations any time through the Thermo Scientific™ Chromeleon™ Chromatography Data System (CDS).

- **Eliminating sodium acetate issues**

Eluent generation eliminates the potential for system contamination due to use of lower-quality sodium acetate.

Example applications using Dual EGC mode

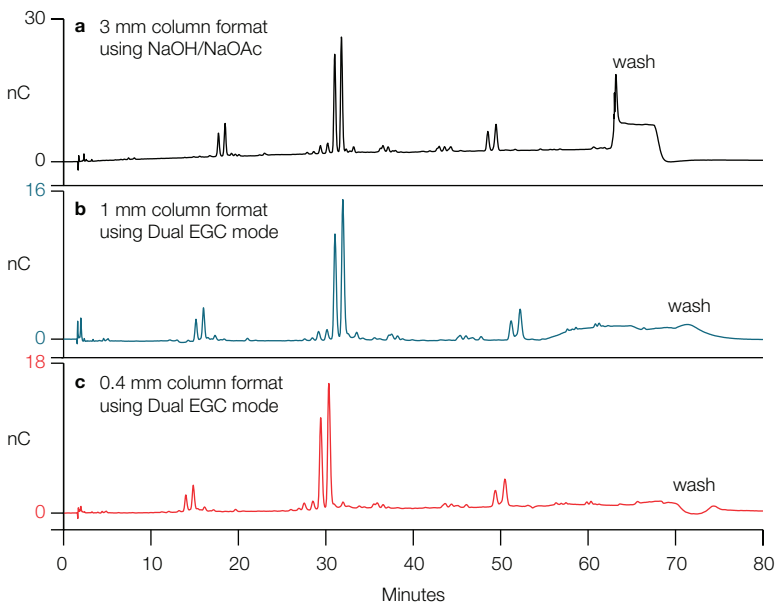

Columns: Dionex CarboPac PA200, 3 mm (guard + separator)
Dionex CarboPac PA200, 1 mm (guard + separator)
Dionex CarboPac PA200, 0.4 mm (guard + separator)

Gradient: Dionex CarboPac PA200, 3 × 250 mm
0–60 min: 20–150 mM NaOAc in 100 mM NaOH
60–65 min: 500 mM NaOAc in 100 mM NaOH
65–80 min 20 mM NaOAc in 100 mM NaOH

Dionex CarboPac PA200, 1 × 250 mm
0–50 min: 15–64 mM KMSA in 136 mM KOH
50–60 min: 80 mM KMSA in 90 mM KOH
60–65 min: 100 mM KMSA in 100 mM KOH
65–80 min: 15 mM KMSA in 136 mM KOH

Dionex CarboPac PA200, 0.4 × 250 mm
0–50 min: 15–64 mM KMSA in 136 mM KOH
50–60 min: 80 mM KMSA in 90 mM KOH
60–65 min: 100 mM KMSA in 100 mM KOH
65–80 min: 15 mM KMSA in 136 mM KOH

Flow rate: Dionex CarboPac PA200, 3 × 250 mm: 0.5 mL/min
Dionex CarboPac PA200, 1 × 250 mm: 0.063 mL/min
Dionex CarboPac PA200, 0.4 × 250 mm: 0.010 mL/min

Detection: Dionex CarboPac PA200, 3 × 250 mm: PAD, Au on PTFE, 2 mil gasket, Ag/AgCl ref.
Dionex CarboPac PA200, 1 × 250 mm: PAD, Au on PTFE, 1 mil gasket, Ag/AgCl ref.
Dionex CarboPac PA200, 0.4 × 250 mm: PAD, Au on PTFE, 1 mil gasket, Ag/AgCl ref.

Samples: 50 μmol/L fetuin oligosaccharide alditol standard

Figure 2. Fetuin oligosaccharide alditol analysis using (a) manually prepared eluents (NaOH/NaOAc) with 3 mm column format, (b) Dual EGC mode (KOH/KMSA) with 1 mm column format (c) Dual EGC mode (KOH/KMSA) with 0.4 mm column format.

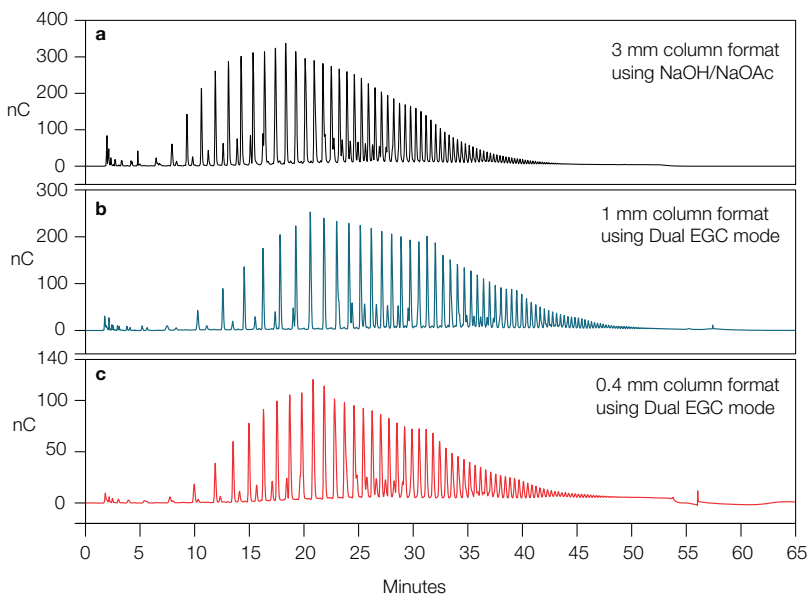

Columns: Dionex CarboPac PA200, 3 mm (guard + separator)
Dionex CarboPac PA200, 1 mm (guard + separator)
Dionex CarboPac PA200, 0.4 mm (guard + separator)

Gradient: Dionex CarboPac PA200, 3 × 250 mm
0–45 min: 100–430 mM NaOAc in 100 mM NaOH
45–50 min: 430 mM NaOAc in 100 mM NaOH
50–65 min 100 mM NaOAc in 100 mM NaOH

Dionex CarboPac PA200, 1 × 250 mm
0–45 min: 40 mM KMSA/60 mM KOH to 156 mM KMSA/22 mM KOH
45–50 min: 156 mM KMSA/22 mM KOH
50–65 min: 40 mM KMSA/60 mM KOH

Dionex CarboPac PA200, 0.4 × 250 mm
0–45 min: 40 mM KMSA/70 mM KOH to 190 mM KMSA/10 mM KOH
45–50 min: 190 mM KMSA/10 mM KOH
50–65 min: 40 mM KMSA/70 mM KOH

Flow rate: Dionex CarboPac PA200, 3 × 250 mm: 0.5 mL/min
Dionex CarboPac PA200, 1 mm: 0.063 mL/min
Dionex CarboPac PA200, 0.4 mm: 0.010 mL/min

Detection: Dionex CarboPac PA200, 3 × 250 mm: PAD, Au on PTFE, 2 mil gasket, Ag/AgCl ref.
Dionex CarboPac PA200, 1 × 250 mm: PAD, Au on PTFE, 1 mil gasket, Ag/AgCl ref.
Dionex CarboPac PA200, 0.4 × 250 mm: PAD, Au on PTFE, 1 mil gasket, Ag/AgCl ref.

Samples: 5 mg/mL Inulin from chicory

Figure 3. Inulin oligosaccharide analysis using (a) manually prepared eluents (NaOH/NaOAc) with 3 mm column format, (b) Dual EGC mode (KOH/KMSA) with 1 mm column format (c) Dual EGC mode (KOH/KMSA) with 0.4 mm column format.

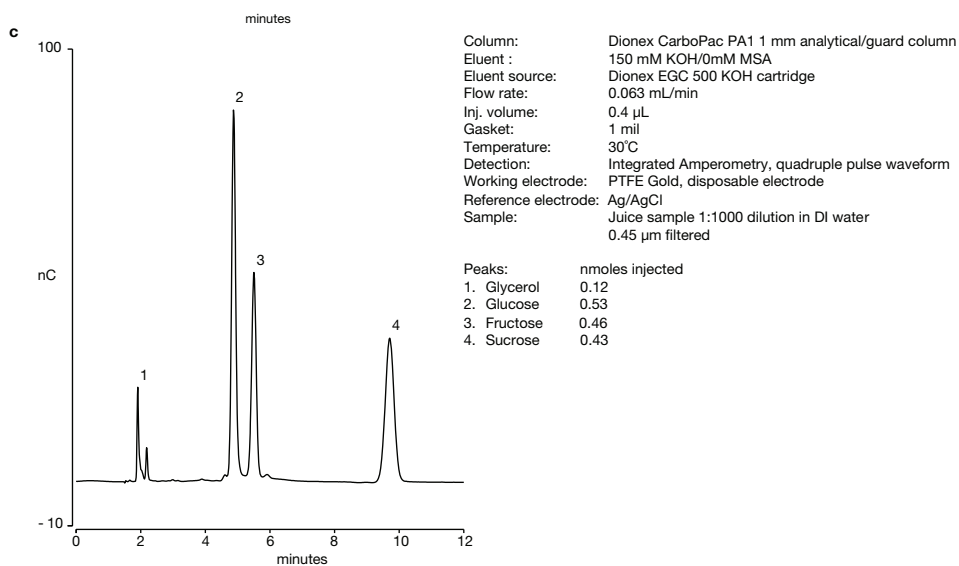
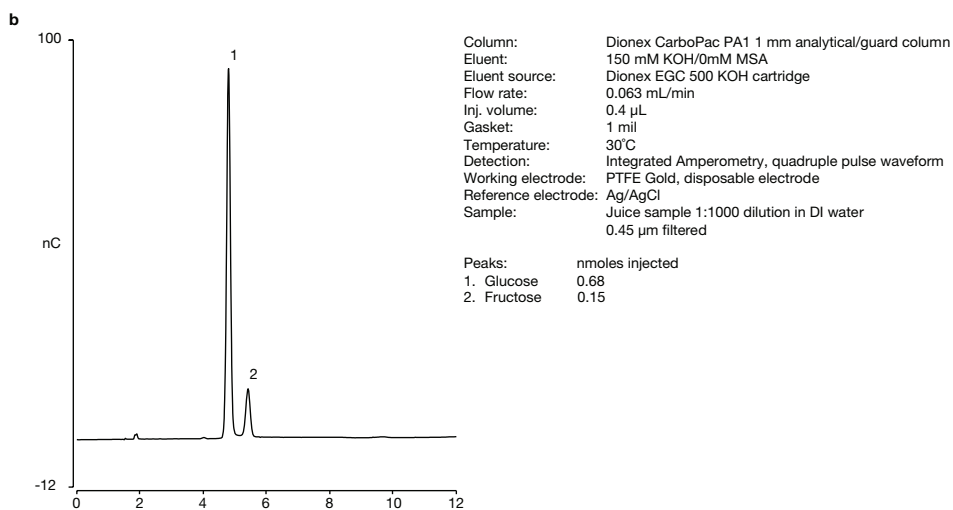
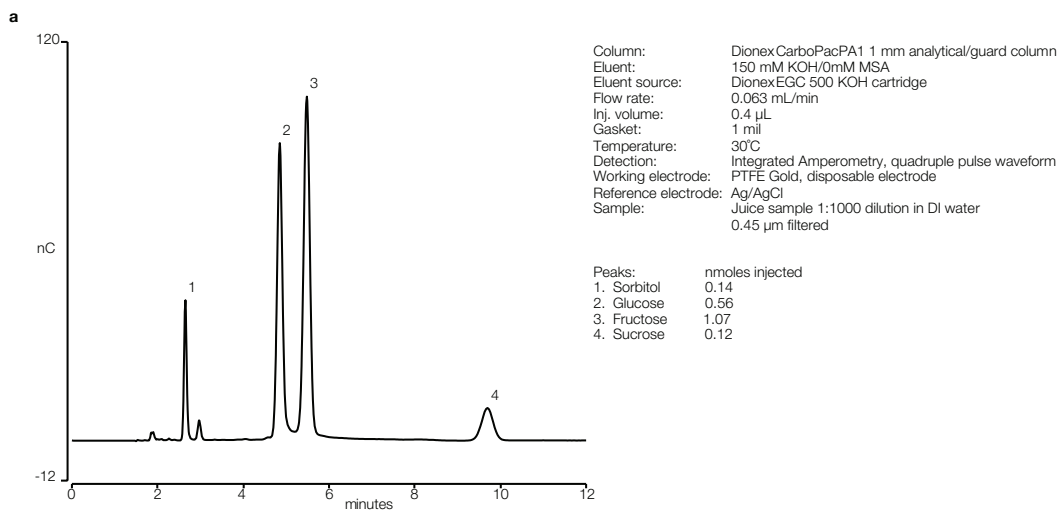

Figure 4. Separation of sugars in fruit juices. (a) apple juice using Dionex CarboPac PA1 (1 mm) column and Dual EGC mode, (b) cranberry juice using Dionex CarboPac PA1 (1 mm) column and Dual EGC mode, and (c) orange juice using Dionex CarboPac PA1 (1 mm) column and Dual EGC mode.

Principles of operation for Dual EGC mode

Dual EGC mode for the analysis of complex carbohydrates is currently supported only on the Dionex ICS-6000 HPIC system and capillary systems, on both 1 mm and 0.4 mm formats using RFIC-EG generated eluents.

• For analytical (1 mm format) operation

The Thermo Scientific™ Dionex™ EGC 400 KOH and MSA Eluent Generator Cartridges are designed to enable operation at flow rates between 20 $\mu\text{L}/\text{min}$ –200 $\mu\text{L}/\text{min}$. A Dionex EGC 400 MSA Eluent Generator Cartridge is connected in series to a Dionex EGC 400 KOH Eluent Generator Cartridge to generate KOH/KMSA eluents up to a total concentration of 200 mM at flow rates of 20–63 $\mu\text{L}/\text{min}$, and up to 63 mM at flow rates up to 200 $\mu\text{L}/\text{min}$.

• For capillary (0.4 mm format) operation

A Dionex EGC MSA (Capillary) Eluent Generator Cartridge is connected in series to a Dionex EGC KOH (Capillary) Eluent Generator Cartridge to generate KOH/KMSA eluents up to a total concentration of 200 mM at flow rates of 1–10 $\mu\text{L}/\text{min}$, and up to 100 mM at flow rates up to 20 $\mu\text{L}/\text{min}$.

Deionized water is pumped into the Dionex EGC 400 MSA cartridge or Dionex EGC MSA (capillary) cartridge to generate methanesulfonic acid. The methanesulfonic acid solution is then passed into the Dionex EGC 400 KOH or EGC KOH (capillary) cartridge respectively to titrate the potassium hydroxide to potassium methanesulfonate. By balancing the concentration of the two cartridges pure KMSA can be generated. By generating an excess of KOH compared to MSA, a basic solution of KMSA plus KOH can be generated (Basic Eluent Mode). By generating an excess of MSA compared to KOH, an acidic solution of KMSA plus MSA can be generated (Acidic Eluent Mode). The system can be switched between the two modes as needed. For applications of analyzing complex carbohydrates, the system is operated under Basic Eluent Mode.

Dual EGC flow diagram

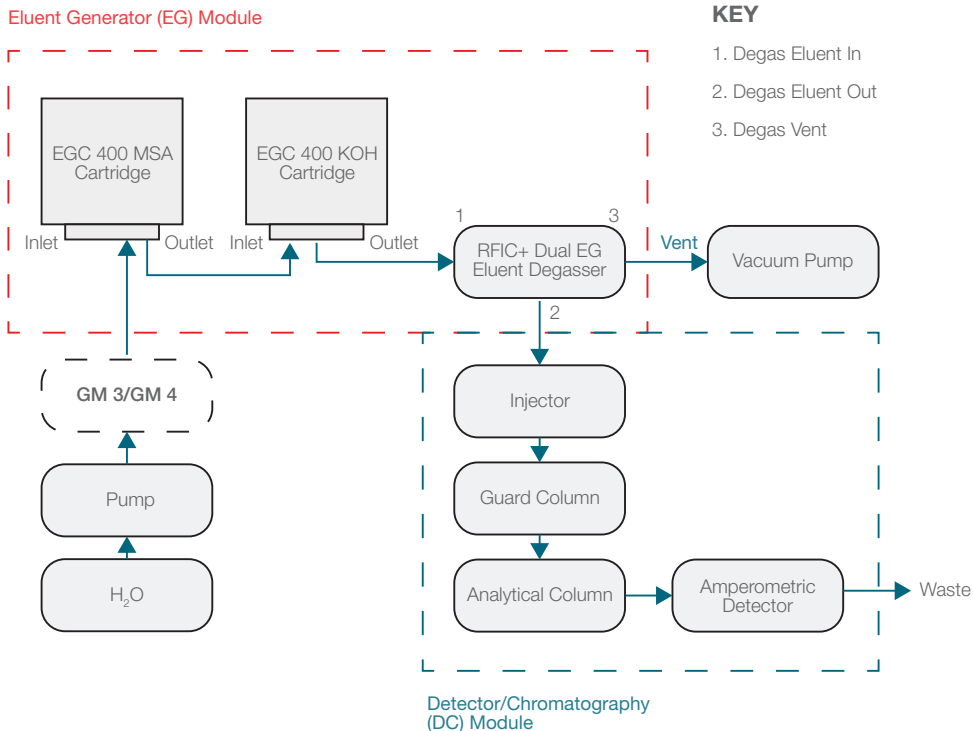

Figure 5. Plumbing schematic using Dionex EGC 400 MSA and Dionex EGC 400 KOH cartridges in an RFIC-EG system for Dual EGC applications.

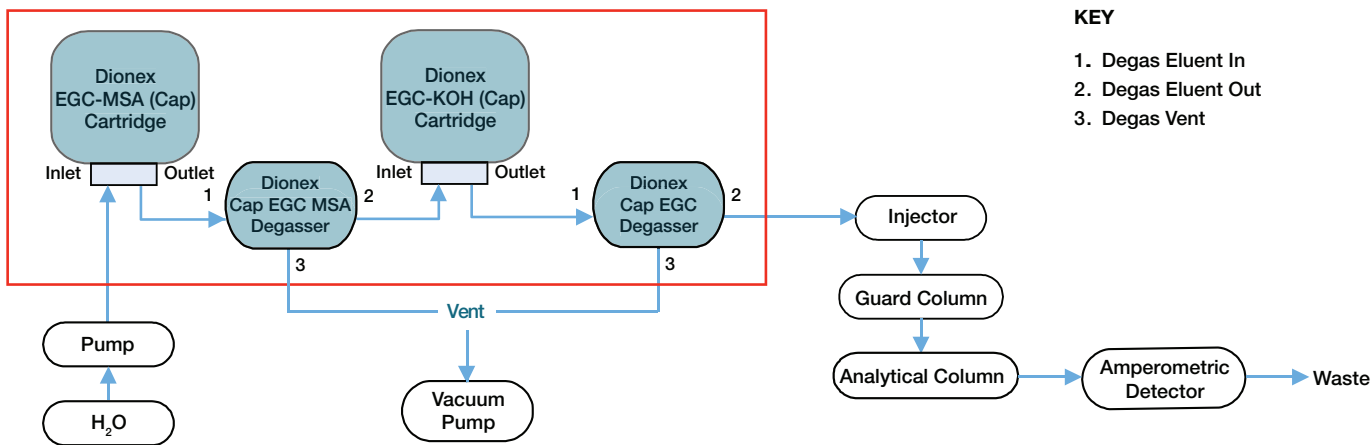

Figure 6. Plumbing schematic using Dionex EGC MSA (Capillary) and Dionex EGC KOH (Capillary) cartridges in an RFIC-EG system for Dual EGC applications.

Key benefits of Dual EGC control

- **Purity**

- Guarantees high-purity eluents at accurate concentrations
- Eliminates system contamination related to sodium acetate quality

- **Precision**

- Removes concentration variation related to manual eluent preparation
- Improves method reproducibility from analyst to analyst, day-to-day, week-to-week, and lab-to-lab

- **Productivity**

- Ensures ease-of-use: no manual preparation of eluents
- Removes instrument downtime related to pump maintenance

Ordering information

Description	Part Number
Thermo Scientific™ Dionex™ CarboPac™ PA200 Analytical Column, 1 × 250 mm	302861
Thermo Scientific™ Dionex™ CarboPac™ PA200 Guard Column, 1 × 50 mm	302862
Thermo Scientific™ Dionex™ CarboPac™ PA200 Analytical Column, 0.4 × 250 mm	302863
Thermo Scientific™ Dionex™ CarboPac™ PA200 Guard Column, 0.4 × 50 mm	302864
Dionex™ EGC 400 KOH Eluent Generator Cartridge	302766
Dionex™ EGC 400 MSA Eluent Generator Cartridge	302767
Thermo Scientific™ Dionex™ EGC-KOH (Capillary) Eluent Generator Cartridge	072076
Thermo Scientific™ Dionex™ EGC-MSA (Capillary) Eluent Generator Cartridge	072077
Thermo Scientific™ Dionex™ CarboPac PA1, 1 mm Analytical Column (1 × 250 mm)	303272
Thermo Scientific™ Dionex™ CarboPac PA1, 1 mm Guard Column (1 × 50 mm)	303273
Thermo Scientific™ Dionex™ CarboPac PA20 1 mm Analytical Column (1 × 150 mm)	303369
Thermo Scientific™ Dionex™ CarboPac PA20 1 mm Guard Column (1 × 30 mm)	303370
Thermo Scientific™ Dionex™ Gold on PTFE Disposable Electrode with 1 mil gasket kit for 1 mm and capillary applications (6 pack)	303397
RFIC+ Dual EG Eluent Degasser (Includes Degasser, Ship Kit, Degas Vacuum Kit)	22181-60951
RFIC+ Dual EG Eluent Degasser Ship Kit	22181-62038
RFIC+ Dual EG Eluent Degas Vacuum Kit	22181-62042
RFIC+ Dual EG, HP Viper Kit	303377

Find out more at thermofisher.com/complexcarbs
and thermofisher.com/DualEGC