



# Mass Spectrometry Applications for Environmental Analysis

- Surface, Drinking and Waste Water Analysis
- Air and Soil Analysis





# Mass Spectrometry Applications for Environmental Analysis

## Table of Contents

- **Surface, Drinking and Waste Water Analysis**

- Pesticides

- Pharmaceuticals and Personal Care Products

- Polyhalogenated Compounds

- Marine Toxins

- Contaminants of Emerging Concern and other Water Analysis

- Speciation Analysis

- **Air and Soil Analysis**



# Surface, Drinking and Waste Water Analysis

Pesticides

# Fast and Accurate Identification of Pesticides by Direct Analysis in Real Time (DART) Ionization with Orbitrap Mass Spectrometry

Jaewon Choi,<sup>1</sup> Wonseok Choi,<sup>1</sup> Jennifer Massi,<sup>2</sup> Mari Prieto Conaway<sup>2</sup>

<sup>1</sup>Water Analysis & Research Center, K water, Daejeon 306-711, Korea

<sup>2</sup>Thermo Fisher Scientific, San Jose, CA, USA

## Key Words

Direct Analysis in Real Time ionization, DART, Exactive, Orbitrap, pesticides, water analysis

## Goal

To describe a method incorporating direct analysis in real time (DART) ionization and Thermo Scientific™ Orbitrap™ high-resolution mass spectrometry for rapid analysis and identification of contaminating substances in water.

## Introduction

When water or soil is contaminated by chemical substances, quick methods of analysis are required to assess the negative impact on the environment. Accidents that have an impact on drinking water require rapid, real-time diagnosis of the chemical substance involved. The contamination is confirmed in the lab after often tedious extraction and concentration processes and instrumental analysis of the target compounds.

Full-scan mass spectrometry is a powerful compound identification technique. However, conventional quadrupole-type scanning produces low-resolution mass spectra. Most contamination accidents involve concentrations at ng/mL levels; therefore, it is essential that the samples be concentrated prior to instrumental analysis. Care must be taken as to not lose the target compound during the pre-treatment or concentration process. For example, polar substances can be lost during liquid-liquid extraction, and limitations in selectivity of materials used in solid-phase extraction (SPE) can hinder adsorption and concentration of the target compound.

Direct analysis in real time (DART®) has recently been introduced as a desorption ionization technology that requires limited or no sample pre-treatment prior to introduction into the mass spectrometer.<sup>1</sup> As a direct spray ionization technique, DART bypasses the conventional high-performance liquid chromatography (HPLC) routinely coupled to MS analysis. It is therefore amenable to high-throughput screening (HTP) and attractive to use in forensics, defense, clinical research, and food applications.<sup>2</sup> Although DART has successfully been coupled to triple quadrupole mass spectrometry<sup>3,4</sup> technology, combining it with high-resolution, accurate mass (HRAM) mass spectrometry<sup>5-7</sup> might lead to higher probability of identifying unknown substances.

In this study, a method incorporating DART and Orbitrap high-resolution mass spectrometry was developed for rapid analysis and identification of contaminating substances in water. A total of 23 commonly used agricultural pesticide target compounds were analyzed (Table 1). The possibility of screening target compounds at the ng/mL concentration level in water samples, indicative of real case scenarios, was also reviewed.

## Experimental

### Target Compounds

Table 1 lists the chemical formulas, molecular weights, and structures of the target pesticides.

Table 1. Target pesticides

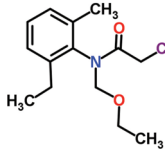
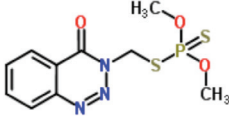
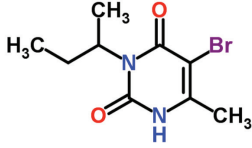
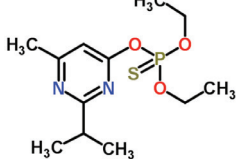
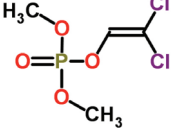
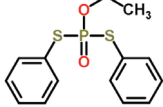
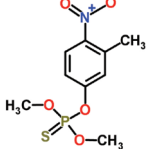
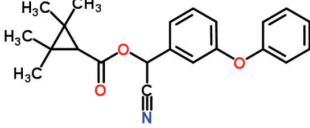
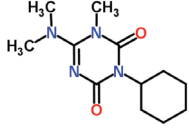
Compound	CAS Number	Formula	Molecular Weight	Chemical Structure
Acetochlor	34256-82-1	$C_{14}H_{20}ClNO_2$	269.7	
Azinphos-methyl	86-50-5	$C_{10}H_{12}N_3O_3PS_2$	317.3	
Bromacil	314-40-9	$C_9H_{13}BrN_2O_2$	261.1	
Diazinon	333-41-5	$C_{12}H_{21}N_2O_3PS$	304.3	
Dichlorovos	95828-55-0	$C_4H_7Cl_2O_4P$	220.9	
Edifenfos	17109-49-8	$C_{14}H_{15}O_2PS_2$	310.3	
Fenitrothion	122-14-5	$C_9H_{12}NO_5PS$	277.2	
Fenpropathrin	39515-41-8	$C_{22}H_{23}NO_3$	349.4	
Hexazinone	51235-04-2	$C_{12}H_{20}N_4O_2$	252.3	

Compound	CAS Number	Formula	Molecular Weight	Chemical Structure
Iprobenfos	26087-47-8	$C_{13}H_{21}O_3PS$	288.3	
Isoproturon	34123-59-6	$C_{12}H_{18}N_2O$	206.2	
Isoxathion	18854-01-8	$C_{13}H_{16}NO_4PS$	313.3	
Metribuzin	21087-64-9	$C_8H_{14}N_4OS$	214.2	
Phorate	298-02-2	$C_7H_{17}O_2PS_3$	260.3	
Procymidone	32809-16-8	$C_{13}H_{11}Cl_2NO_2$	284.1	
Prometryn	7287-19-6	$C_{10}H_{19}N_5S$	241.3	
Propiconazole	60207-90-1	$C_{15}H_{17}Cl_2N_3O_2$	342.2	
Prothiofos	34643-46-4	$C_{11}H_{15}Cl_2O_2PS_2$	345.2	
Pyrazophos	13457-18-6	$C_{14}H_{20}N_3O_5PS$	373.3	

Compound	CAS Number	Formula	Molecular Weight	Chemical Structure
Tefluthrin	79538-32-2	$C_{17}H_{14}ClF_7O_2$	418.7	
Terbufos	13071-79-9	$C_9H_{21}O_2PS_3$	288.4	
Terbutryn	886-50-0	$C_{10}H_{19}N_5S$	241.3	
Trichlorfon	66758-31-4	$C_4H_8Cl_3O_4P$	257.4	

#### Direct Analysis in Real Time (DART)

A DART source with a Standardized Voltage and Pressure (SVP) controller (IonSense™, MA, USA) was used as the ionization source. The ionization mechanism in DART is Penning ionization.<sup>8</sup> It relies upon fundamental principles of atmospheric pressure chemical ionization (APCI). Excited-state helium atoms produce reactive species for analyte ionization.<sup>1</sup> Figure 1 shows a schematic diagram of DART technology.

The operating temperature range of the DART-SVP source is 50–500 °C, and the optimal temperature for the studied compounds was found to be 300 °C. The ionization and instrumental analysis time was set to 30 sec. The DART operating conditions are summarized in Table 2.

Samples were loaded onto a strip that contained 10 spots for sample deposition. Each sample was individually deposited on a metal mesh and allowed to dry before the strip was fitted on the DART source. The strip was then set to run and each sample was presented in front of the mass spectrometer for analysis. Hot helium gas flowed through the sample/mesh, ionizing the sample by an atmospheric pressure chemical ionization (APCI)-like mechanism.

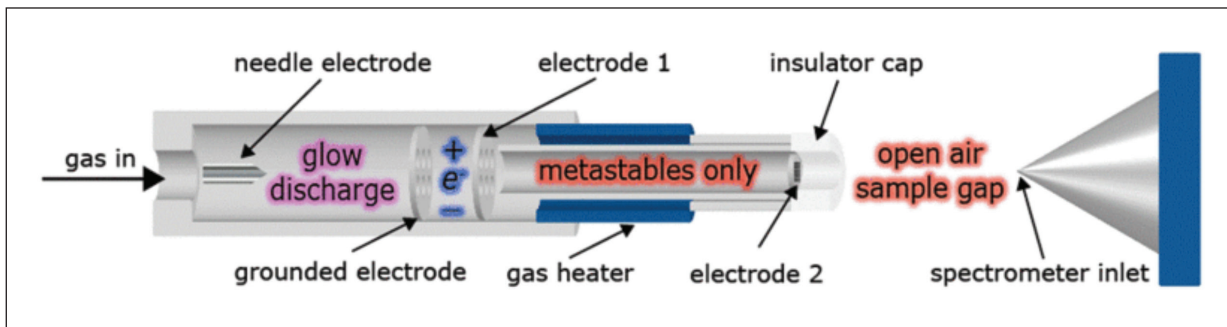

Figure 1. DART technology



Table 2. Operating conditions of desorption ionization probe

Instrument	DART-SVP
Temperature	300 °C
Sample loading volume	5 $\mu$ L
Carrier gas, pressure	Helium, 75 psi

### Mass Spectrometry

Due to the absence of separation in the DART source, the whole sample is introduced into the mass spectrometer. This unavoidably leads to a significant number of spectral interferences. To correctly determine the masses of relevant compounds and potential unknowns in the case of fingerprinting analysis, it is essential to separate them from the matrix ions. A mass spectrometer based on Orbitrap™ technology achieves high mass resolving power while maintaining excellent mass accuracy, without the use of internal mass correction.<sup>9</sup> These features make it an ideal tool to complement DART ionization for the analysis of complex samples.

A Thermo Scientific™ Exactive™ Orbitrap high-resolution, accurate-mass mass spectrometer was used in full scan mode. The resolving power was set to 50,000 (FWHM) at  $m/z$  200. The detailed conditions for the operation of the mass spectrometer are summarized in Table 3.

Table 3. MS operating conditions

Parameter	Setting
Scan range	$m/z$ 100–500
Resolving power	50,000 (FWHM at $m/z$ 200)
Polarity	Positive
Run time	0.5 min
Spray voltage	0 kV
Capillary temperature	250 °C
Capillary voltage	25 V
Tube lens voltage	170 V
Skimmer voltage	36 V

## Results and Discussion

### Mass Spectrum of Quinine and Mass Accuracy

Prior to analyzing the agricultural pesticides under review, quinine ( $C_{20}H_{24}N_2O_2$ ) was selected as a standard compound for preliminary testing. A spectrum of quinine was collected and analyzed using the DART-Exactive MS. Five microliters of 1 ng/ $\mu$ L solution was applied to a metal mesh using a micropipette. The mass spectrum for quinine shown in Figure 2, was acquired under the operating conditions outlined in Table 3. Comparison using the simulated elemental composition feature in Thermo Scientific™ Xcalibur™ software version 2.1 confirmed the results and presence of carbon isotopes in the form of  $[M+H]^+$ . A mass accuracy 0.632 ppm was measured, so it was possible to confirm the compound within an accuracy of <1ppm.

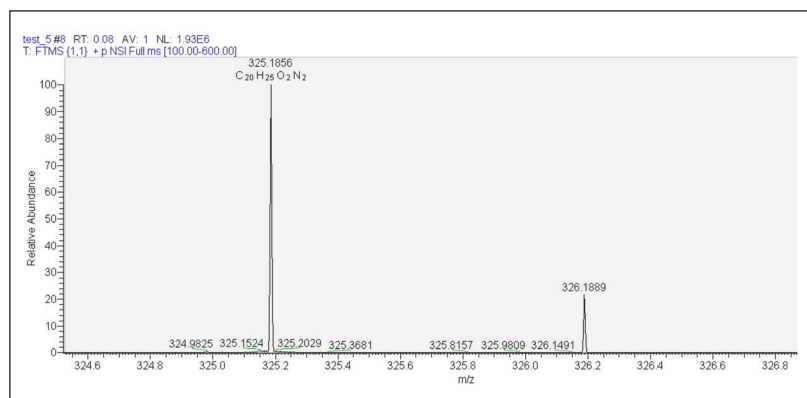
Figure 2. Preliminary expanded ionization spectrum of quinine ( $C_{20}H_{24}N_2O_2$ )

### Mass Spectrum Measurement of Target Compounds

A diluted solution of the 23 standard agricultural pesticides was prepared at a concentration of 500 ng/mL each and was measured three times under the DART-Exactive MS conditions described in the previous section. The mass spectra and corresponding mass accuracies were recorded and confirmed by comparison to the simulated elemental composition. The mass spectra and accuracies of the target compounds are summarized in Table 4 and Figure 3. All agricultural pesticides were detected as  $[M+H]^+$ , similar to quinine. There were no  $Na^+$  or  $NH_4^+$  adducts detected, confirming the ionization as a Penning-type mechanism. The carbon isotopic distribution was also used to confirm the compounds. Those target compounds with a chlorine atom, such as procymidone, acetochlor, propiconazole, dichlorovos, tefluthrin, and prothiophos, showed isotopic ratios typical of Cl-35 to Cl-37, with its natural abundance ratio of 3:1. Bromacil, with bromine, showed the natural abundance isotopic pattern of Br-79 to Br-81, which is 1:1. Mass accuracy was observed to be in the range of 0.053 to 0.870 ppm, which satisfied the condition of being less than 1 ppm. Thus, DART combined with HRAM mass spectrometry has substantial advantages as an identification analysis method.

Table 4. Protonated or molecular and isotopes for identification within 5 ppm mass accuracy

Compound	[M+H] <sup>+</sup>	Qual Ion 1	Qual Ion 2	Qual Ion 3	Qual Ion 4
Acetochlor	270.1255	271.1288	272.1226	273.1262	
Azinphos-methyl	318.0131	319.0166	320.0088	321.0211	322.7027
Bromacil	261.0235	262.0266	263.0209	264.0240	
Diazinon	305.1083	306.1114	307.1038	308.1071	309.2028
Dichlorovos	222.9497	221.9448	224.9465		
Edifenfos	311.0326	312.0306	313.0282		
Fenitrothion	278.0247	279.0278	280.0202	281.0232	282.0270
Fenpropathrin	350.1754	351.1784	352.1815	353.1843	
Hexazinone	253.1660	254.1668	255.1725		
Iprobenfos	289.1022	290.1054	291.0978	292.1010	
Isoproturon	207.1494	208.1522	209.1554		
Isoxathion	314.0610	315.0639	316.0564	317.0595	318.0609
Metribuzin	215.0962	216.0989	217.0914	218.0946	
Phorate	260.9805	261.9837	262.9761		
Procymidone	286.0297	287.0275	288.0253		
Prometryn	242.1436	243.1459	244.1386	245.1417	
Propiconazole	342.0772	344.0739	346.0708		
Prothiofos	346.9667	348.9633	350.1746		
Pyrazophos	374.0932	375.0101	376.3505		
Tefluthrin	419.0645	420.0664	421.0615		
Terbufos	289.0515	290.0550	291.0572		
Terbutryn	242.1435	243.1462	244.1387	245.1420	
Trichlorfon	256.9301	258.9271	260.9241	262.9208	

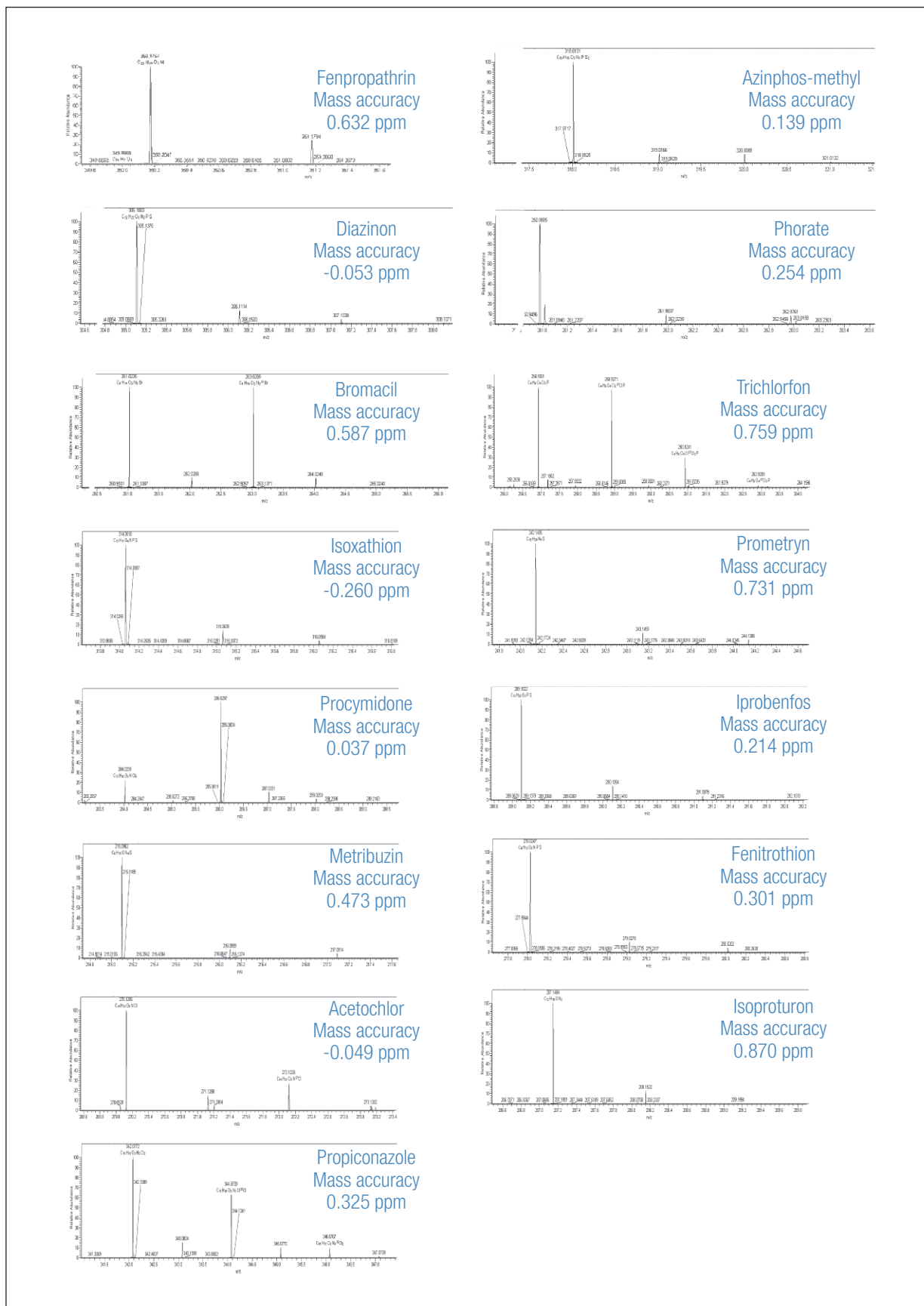

Figure 3. Molecular ions and isotopes in expanded spectra of target pesticides

## Low-Concentration Test Considering Water Contamination

The analysis method reviewed in this study enables accurate quantitation analysis within a matter of minutes and is expected to be of significant value in cause identification and result notification, allowing rapid response in the field. However, the majority of water contamination by chemical substances occurs in concentration levels of ng/mL, as observed in dioxane contamination, oil spills, and agricultural pesticide sprays, among others. Thus, there is a need to perform quantitation analysis for low-concentration samples. To review the possibility of detecting trace amounts of the target compounds in low-concentration samples, acetochlor ( $C_{14}H_{20}ClNO_2$ ), one of the pesticides outlined in the previous section, was selected for analysis. The compound was serially diluted using tap water from the lab to 100, 50, 20, 10, 5, and 1 ng/mL solutions, and 10  $\mu$ L of each of the diluted solutions was applied to the surface of a metal mesh. The mass spectrum for each of the concentrations is shown in Figure 4. The monoisotopic mass of acetochlor is 269.271 amu, with chlorine isotopes at  $[M+H]^+$  270.1258 amu and 272.1231 amu, respectively. These were observed at a ratio of 3:1 at the minimum concentration of 1 ng/mL. We can thus conclude that rapid and accurate quantitation using DART-Exactive MS presents a promising possibility in the analysis of trace amounts of target compounds, the common case in water contamination.

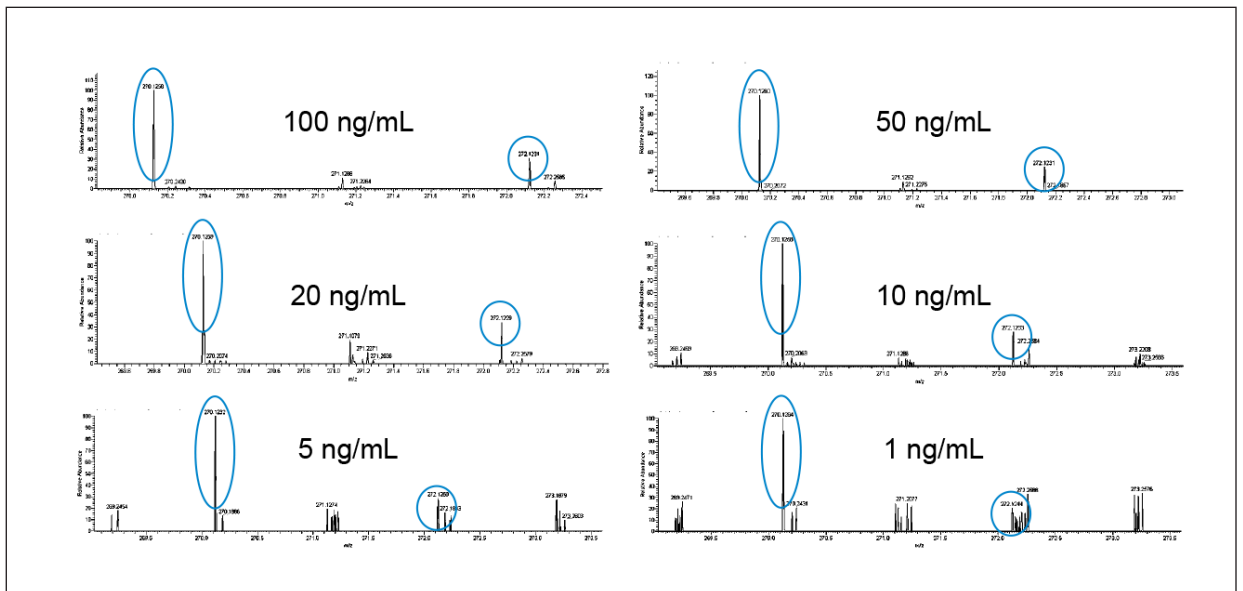

Figure 4. Sensitivity test of acetochlor spiked in tap water

### Productivity and Utilization of DART

Chemical terrorism involving contamination of drinking water and/or food targeting a non-specific group creates the need to develop appropriate countermeasures. To confirm the contaminating compound using the conventional microanalysis method on five samples, for example, would require approximately 0.5 to 1 L of sample and take 2.5 to 3 hours for filtration and liquid-liquid extraction (LLE) or solid-phase extraction (SPE) and 1.2 hours for instrumental analysis. On the other hand, the method described here would require only 5 to 10  $\mu\text{L}$  of sample and only 0.5 minutes of analysis time. Thus, DART provides speed in comparison to the conventional method.

Although it was not reviewed in this study, quantitation review cases on the application of the DART-high-resolution mass spectrometry (HRMS) method have been reported.<sup>10,11</sup> If the injection method was to be automated, this method could be especially useful in the fields of water, food, and soil quality control, as it could be used to identify the contaminating compound and confirm its concentration at the same time. Also, desorption ionization methods including DART have a simple ionization mechanism. This reduces the time necessary for optimization and the cost related to the solvent, column, and condition establishment time, etc., necessary when using HPLC. As such, this method is expected to have diverse applicability in environmental analysis including quantitation.

### Conclusion

In this study, DART, a direct analysis technique that has been introduced for rapid response to water contamination accidents, was combined with Exactive Orbitrap HRAM MS. Its performance as a microanalysis method for trace amounts of contaminants in water was reviewed. Based on the results, the following conclusions were reached:

- An analysis of agricultural pesticides using DART-Orbitrap MS showed that it was possible to produce accurate identification with a mass accuracy within 1 ppm in a very short period of time without any sample pre-treatment.
- This method demonstrated a detection limit of 1 ng/mL in a sensitivity test using acetochlor, without prior extraction or sample concentration, showing the possibility of using it as a method to detect trace amounts of target compounds.
- The DART method was observed to significantly reduce the analysis time and labor necessary. The speed of the method could also be an advantage if an urgent analysis is needed in the event of an accident that could potentially have a negative impact on the environment. It is also a simple, environmentally-conscious analysis technique, as it does not require large amounts of solvent.

## References

1. R.B Cody, J.A. Laramee and H.D. Durst, *Anal. Chem* **2005**, *77*, 2297-2302.
2. J. Gross, *Mass Spectrometry 2011*, 2nd ed., DOI 10.1007/978-3-642-10711-5\_13
3. A.R. Lachapelle and S. Sauvé, 60th ASMS, 2012, WOA, Vancouver, Canada.
4. M. Sollicec, D. Masse, D. Lapen and S. Sauvé, 60th ASMS, 2012, MP 545, Vancouver, Canada.
5. A.G. Escudero and C. Thompson, 60th ASMS, 2012, TP 623, Vancouver, Canada.
6. S.W. Cha, 60th ASMS, 2012, WP 338, Vancouver, Canada.
7. J.M. Wiseman, D.R. Ifa, A. Venter and R.G. Cooks, *Nature Protocols* **2008**, *3*, 517-524
8. L. Song, C.G. Stephen, D. Bhandari, D.C. Kelsey and J.E. Bartmess, *Anal. Chem* **2009**, *81*, 10080-10088.
9. A. Makarov, M. Scigelova, *J. Chromatogr. A.* **2010**, *1217*(25), 3938-45.
10. L. Yan-Jing, W. Zhen-Zhong, B. Yu-An, D. Gang, S. Long-Sheng, Q. Jian-Ping, X. Wei, L. Jia-Chun, W. Yong-Xiang and W. Xue, 60th ASMS, 2012, ThP 644, Vancouver, Canada.
11. M. Haunschmidt, C.W. Klampfl, W. Buchberger and R. Hertsens, *Anal. Bioanal.Chem.* **2010**, *97*, 269.

## www.thermoscientific.com

©2014 Thermo Fisher Scientific Inc. All rights reserved. DART is a registered trademark of JEOL USA, Inc. IonSense is a trademark of IonSense, Inc. All other trademarks are the property of Thermo Fisher Scientific and its subsidiaries. This information is presented as an example of the capabilities of Thermo Fisher Scientific products. It is not intended to encourage use of these products in any manners that might infringe the intellectual property rights of others. Specifications, terms and pricing are subject to change. Not all products are available in all countries. Please consult your local sales representative for details.

<b>Africa</b> +43 1 333 50 34 0	<b>Denmark</b> +45 70 23 62 60	<b>Japan</b> +81 45 453 9100	<b>Singapore</b> +65 6289 1190
<b>Australia</b> +61 3 9757 4300	<b>Europe-Other</b> +43 1 333 50 34 0	<b>Latin America</b> +1 561 688 8700	<b>Spain</b> +34 914 845 965
<b>Austria</b> +43 810 282 206	<b>Finland</b> +358 9 3291 0200	<b>Middle East</b> +43 1 333 50 34 0	<b>Sweden</b> +46 8 556 468 00
<b>Belgium</b> +32 53 73 42 41	<b>France</b> +33 1 60 92 48 00	<b>Netherlands</b> +31 76 579 55 55	<b>Switzerland</b> +41 61 716 77 00
<b>Canada</b> +1 800 530 8447	<b>Germany</b> +49 6103 408 1014	<b>New Zealand</b> +64 9 980 6700	<b>UK</b> +44 1442 233555
<b>China</b> 800 810 5118 (free call domestic) 400 650 5118	<b>India</b> +91 22 6742 9494	<b>Norway</b> +46 8 556 468 00	<b>USA</b> +1 800 532 4752
	<b>Italy</b> +39 02 950 591	<b>Russia/CIS</b> +43 1 333 50 34 0	

**Thermo**  
SCIENTIFIC

A Thermo Fisher Scientific Brand



# A Rapid Solution for Screening and Quantitating Targeted and Non-Targeted Pesticides in Water using the Exactive Orbitrap LC/MS

Olaf Scheibner<sup>1</sup>, Maciej Bromirski<sup>1</sup>, Nick Duczak<sup>2</sup>, Tina Hemenway<sup>2</sup>

<sup>1</sup>Thermo Fisher Scientific, Bremen, Germany; <sup>2</sup>Thermo Fisher Scientific, San Jose, CA, USA

## Introduction

Within the field of environmental analysis, the demand for quick and simple techniques to analyze large numbers of samples is growing each year. While the limits of quantitation (LOQs) required by governmental authorities are lowered almost yearly, the number of analytes of interest is growing exponentially. By using high-resolution, accurate mass (HRAM) liquid chromatography-mass spectrometry (LC-MS) (at least 50,000 resolution) and full-scan experiments, compound identification, screening and quantitation for an unlimited number of compounds in a targeted or non-targeted screening approach can be accomplished with only one chromatographic run.

A very simple, easy-to-reproduce screening and quantitation method to identify pesticides in surface water, ground water, and drinking water is presented here. All samples were analyzed by using online solid phase extraction (SPE) coupled to a Thermo Scientific Exactive high performance benchtop mass spectrometer. The acquired HRAM data was processed by using Thermo Scientific ExactFinder software for unified qualitative and quantitative data processing. All targeted pesticides in the entire mixture were identified, and a number of non-targeted pesticides were found and confirmed by elemental composition. In the same workflow, all samples underwent quantitative analysis.

## Goal

To demonstrate a screening and quantitation method for pesticides in water developed for the Thermo Scientific EQUAN MAX system utilizing ExactFinder™ software to process the HRAM data.

## Experimental

### Sample Preparation

A variety of water samples, including surface water, ground water, and drinking water, were spiked with 20 pesticides (Table 1) at different levels. The pesticide mixture consisted of very nonpolar analytes together with very polar metabolites, representing the full range of polarity characteristics, apart from ionic compounds, normally found in environmental analyses. A dilution series of the same pesticide mixture was provided in ultrapure water at six different levels for calculation of a calibration curve.

## HPLC

All samples were injected onto the EQUAN MAX automated high throughput LC-MS system without further treatment (Figure 1). The EQUAN MAX system offers online-SPE for preconcentration of samples up to 20 mL. By using the EQUAN MAX system, the analysis of compounds in the ng/L or even lower concentrations are possible, saving time and capital by automation of the extraction and preconcentration process. To achieve a reliable extraction of all nonpolar analytes and polar metabolites in one run, two extraction columns with different polarity characteristics were coupled. A nonpolar column with C18 selectivity (Thermo Scientific Hypersil GOLD 20 x 2.1 mm, 12 µm particle size) was placed upstream of a very polar column (Thermo Scientific Hypercarb 10 x 2.1 mm, 5 µm particle size). Elution of the trapped analytes and the transfer to the analytical column (Hypersil™ GOLD PFP 100 x 2.1 mm, 1.9 µm particle size) were carried out in backflush mode to prevent retention of the nonpolar compounds trapped on the C18 column through contact with the Hypercarb™ material. The injection volume for all samples was 1000 µL.

Table 1. Pesticides and their metabolites spiked into water samples

Compound Name	Elemental Composition
Alachlor	C <sub>14</sub> H <sub>20</sub> NO <sub>2</sub> Cl
Atrazine	C <sub>8</sub> H <sub>14</sub> N <sub>5</sub> Cl
Atrazine Desethyl-	C <sub>6</sub> H <sub>10</sub> N <sub>5</sub> Cl
Atrazine Desisopropyl-	C <sub>5</sub> H <sub>8</sub> N <sub>5</sub> Cl
Carbamazepine	C <sub>15</sub> H <sub>12</sub> N <sub>2</sub> O
Chloridazon	C <sub>10</sub> H <sub>8</sub> N <sub>3</sub> OCl
Chloridazon Desphenyl-	C <sub>4</sub> H <sub>4</sub> N <sub>3</sub> OCl
Chloridazon Methyl-desphenyl-	C <sub>5</sub> H <sub>6</sub> N <sub>3</sub> OCl
Chlortoluron	C <sub>10</sub> H <sub>13</sub> N <sub>2</sub> OCl
Diuron	C <sub>9</sub> H <sub>10</sub> N <sub>2</sub> OCl <sub>2</sub>
Isoproturon	C <sub>12</sub> H <sub>18</sub> N <sub>2</sub> O
Lenacil	C <sub>13</sub> H <sub>18</sub> N <sub>2</sub> O <sub>2</sub>
Metalaxyl	C <sub>15</sub> H <sub>21</sub> NO <sub>4</sub>
Metamitron	C <sub>10</sub> H <sub>10</sub> N <sub>4</sub> O
Metazachlor	C <sub>14</sub> H <sub>18</sub> N <sub>3</sub> OCl
Metolachlor	C <sub>15</sub> H <sub>22</sub> NO <sub>2</sub> Cl
Metribuzin	C <sub>8</sub> H <sub>14</sub> N <sub>4</sub> OS
Quinoxifen	C <sub>15</sub> H <sub>8</sub> NOCl <sub>2</sub> F
Simazine	C <sub>7</sub> H <sub>12</sub> N <sub>5</sub> Cl
Terbuthylazine	C <sub>9</sub> H <sub>16</sub> N <sub>5</sub> Cl

## Key Words

- EQUAN MAX
- Exactive
- ExactFinder
- Pesticide screening
- Water analysis



Figure 1. EQuan MAX system equipped with the Exactive mass spectrometer and ExactFinder software

### Mass Spectrometry

All experiments were performed on an Exactive™ benchtop LC-MS powered by Thermo Scientific Orbitrap technology using a heated electrospray ionization source (HESI-II). The mass spectrometer was operated in positive/negative switching mode with a full-scan setting.

MS parameter settings:

Spray voltage:	4100 V in positive mode and 3100 V in negative mode
Sheath gas pressure (N <sub>2</sub> ):	30 (arbitrary units)
Auxiliary gas pressure (N <sub>2</sub> ):	5 (arbitrary units)
Capillary temperature:	250 °C
Heater temperature (HESI-II):	300 °C
Resolution:	50,000 (FWHM at <i>m/z</i> 200)
Acquisition time:	20.00 min
Polarity switching:	One full cycle in less than 1 sec

The analysis was run using conditions described earlier<sup>1,2</sup> without doing any application-specific tuning of the instrument. Quantitative and qualitative data were collected in the same run and data file.

### Results and Discussion

Data processing was carried out with ExactFinder software for qualitative and quantitative workflows. All analytes gave very good linear response in the calibration range (0.02 to 0.60 µg/L) and did not show any interference with other analytes or matrix components (Figure 2). The quantitation data showed good

reproducibility and good recovery rates, as determined by the addition of internal standard to every sample. The specificity of analysis was achieved by applying a mass window of 5 ppm to the theoretical mass of the analytes.

In addition, both targeted and non-targeted screening processes were applied to all samples. Exact mass and retention time were used as identification criteria in the targeted screen (Figure 3). Confirmation of identity was achieved by automated matching of the given elemental composition with the isotopic pattern of the determined signal. An example of isotopic pattern matching is given in Figure 4. ExactFinder software can also provide compound identification through the following criteria: occurrence of up to five fragment ions, library spectra match, and internet database search via ChemSpider®.

The remaining peaks were also screened against a larger compound list. For all signals, elemental compositions were calculated based on the isotopic distribution of a pre-defined list of elements.

The non-targeted screening yielded additional compounds present in the samples. For example, in addition to the targeted compounds, we found the presence of carbendazim in some of the samples and thiometoxam in one. For most of the signals, elemental compositions were determined. All 20 analytes of interest were easily quantified and assigned as knowns in the automated screen. The non-targeted screening yielded additional identifications of analytes without additional analytical effort.

To ensure maximum detection of all possible ions from the samples analyzed, the Exactive mass spectrometer was operated in positive/negative switching mode. This did not affect the mass accuracy or sensitivity of the system at

any time. The same results were achieved by performing the analysis in separate runs with the mass spectrometer operating in positive mode for one run and in negative mode for the other.

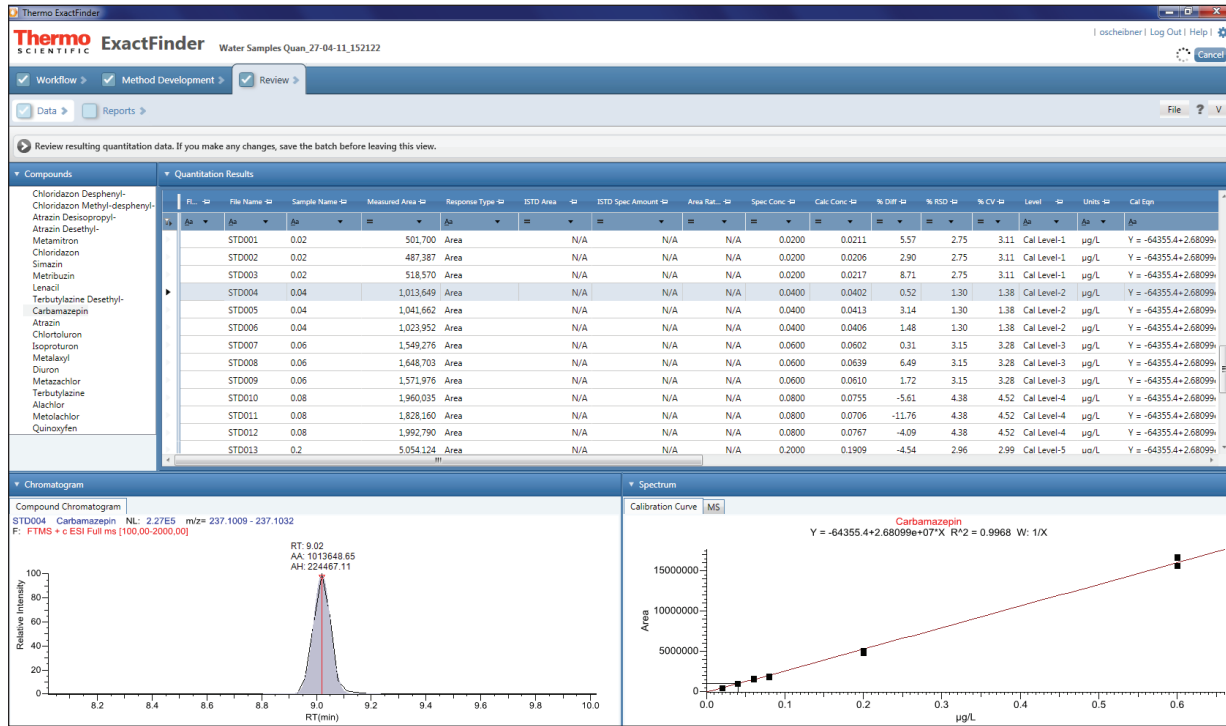

Figure 2. Quantitation Results section of ExactFinder software

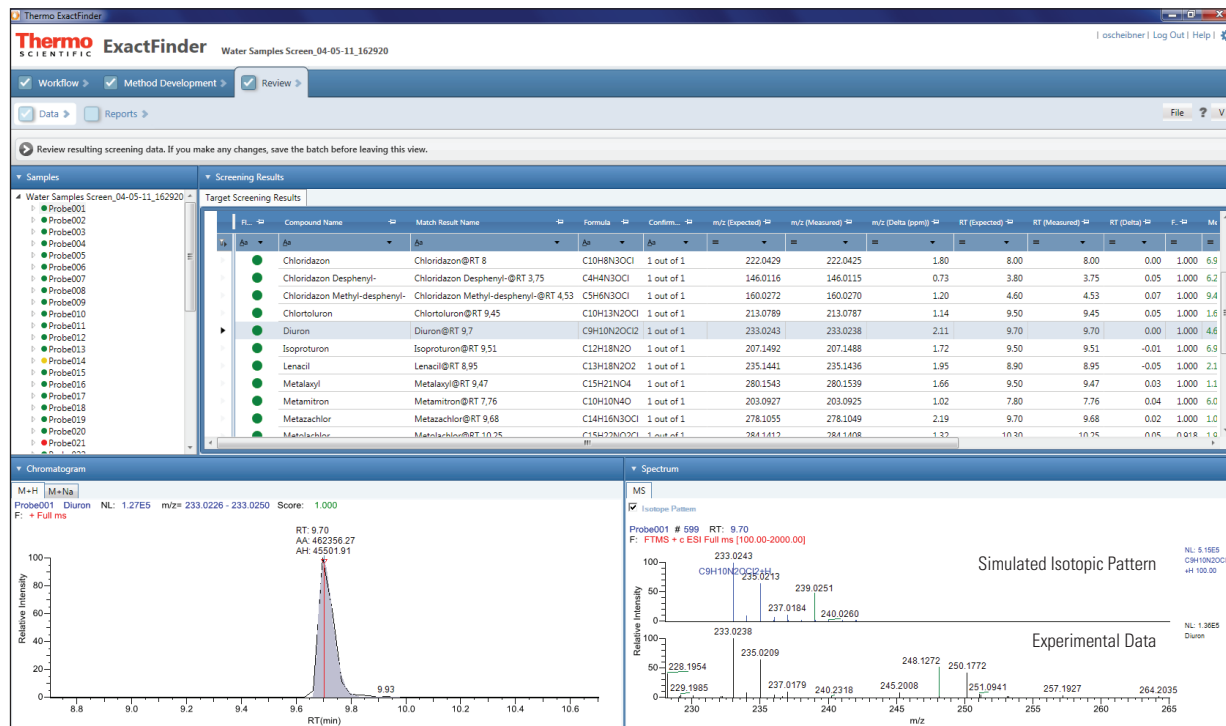

Figure 3. Target Screening Results section of ExactFinder software

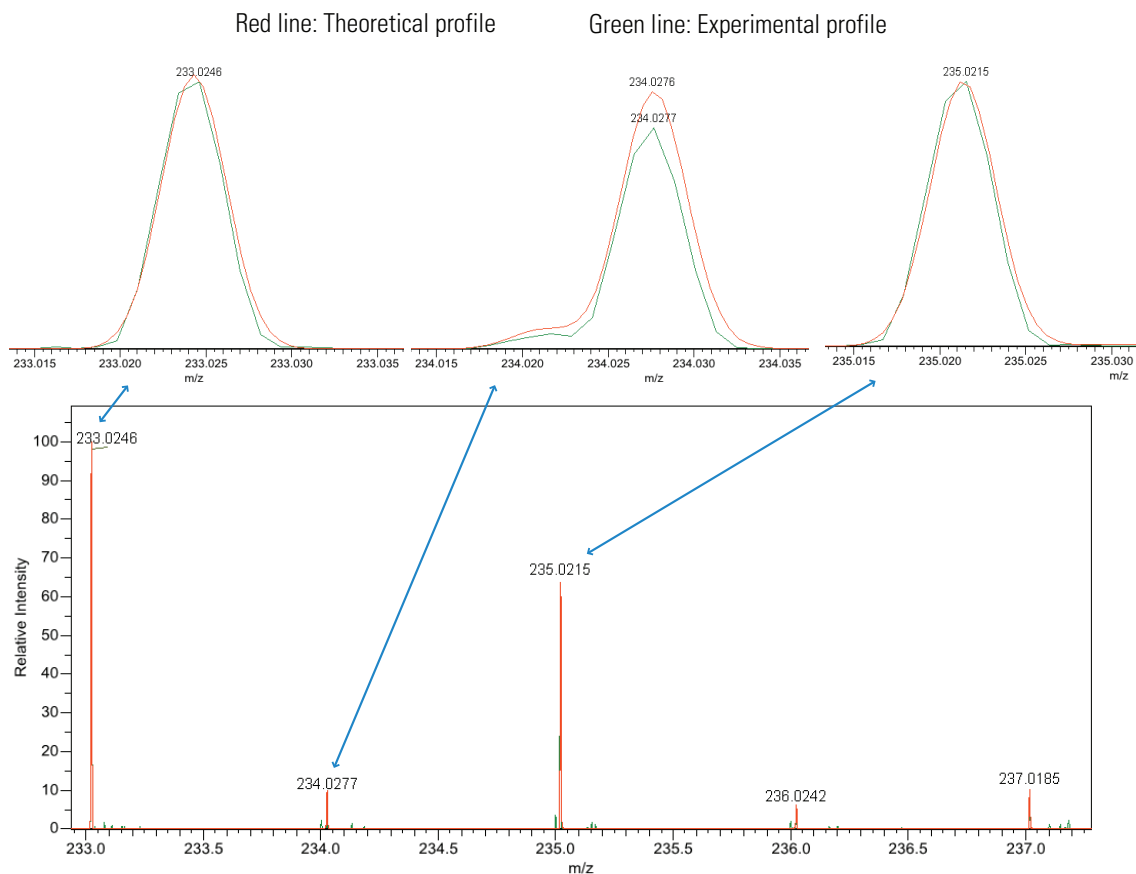

Figure 4. Isotopic pattern matching example

## Conclusion

In this screening and quantitation method to identify pesticides in water, the combination of two different extraction columns yielded easy access to a wide range of environmental compounds in one general approach. ExactFinder software provided a single streamlined workflow with high productivity and confidence required for targeted and non-targeted screening experiments. Full qualitative data was attained from the same data set in one workflow, and a wide range of confirmation tools for known analytes were available. An additional search led to the identification of a number of non-targeted analytes and yielded a large number of compounds, to which elemental compositions can be assigned in most cases. Lastly, acquiring the data at 50,000 resolution reduces the likelihood of coeluting isobaric interferences and thus diminishes the likelihood of false positives.

## References

1. Zhang, A., Chang, J., Gu, C., Sanders, M. *Non-targeted Screening and Accurate Mass Confirmation of 510 Pesticides on the High Resolution Exactive Benchtop LC/MS Orbitrap Mass Spectrometer*, Thermo Fisher Scientific Application Note 51878, 2010.
2. Beck, J., Yang, C. *LC-MS/MS Analysis of Herbicides in Drinking Water at Femtogram Levels Using 20 mL EQUAN Direct Injection Techniques*, Thermo Fisher Scientific Application Note 437, 2008.

In addition to these offices, Thermo Fisher Scientific maintains a network of representative organizations throughout the world.

**Africa-Other**  
+27 11 570 1840

**Australia**  
+61 3 9757 4300

**Austria**  
+43 1 333 50 34 0

**Belgium**  
+32 53 73 42 41

**Canada**  
+1 800 530 8447

**China**  
+86 10 8419 3588

**Denmark**  
+45 70 23 62 60

**Europe-Other**  
+43 1 333 50 34 0

**Finland/Norway/Sweden**  
+46 8 556 468 00

**France**  
+33 1 60 92 48 00

**Germany**  
+49 6103 408 1014

**India**  
+91 22 6742 9434

**Italy**  
+39 02 950 591

**Japan**  
+81 45 453 9100

**Latin America**  
+1 561 688 8700

**Middle East**  
+43 1 333 50 34 0

**Netherlands**  
+31 76 579 55 55

**New Zealand**  
+64 9 980 6700

**Russia/CIS**  
+43 1 333 50 34 0

**South Africa**  
+27 11 570 1840

**Spain**  
+34 914 845 965

**Switzerland**  
+41 61 716 77 00

**UK**  
+44 1442 233555

**USA**  
+1 800 532 4752

[www.thermofisher.com](http://www.thermofisher.com)

Legal Notices: ©2016 Thermo Fisher Scientific Inc. All rights reserved. ChemSpider is a registered trademark of ChemZoo, Inc. and is a service currently provided by the Royal Society of Chemistry. All other trademarks are the property of Thermo Fisher Scientific Inc. and its subsidiaries. This information is presented as an example of the capabilities of Thermo Fisher Scientific Inc. products. It is not intended to encourage use of these products in any manners that might infringe the intellectual property rights of others. Specifications, terms and pricing are subject to change. Not all products are available in all countries. Please consult your local sales representative for details.

AN63413\_E 08/16S

# Analysis of Early Eluting Pesticides in a C18-Type Column Using a Divert Valve and LC-MS/MS

Eugene Kokkalis<sup>1</sup>, Anna Rentinioti<sup>1</sup>, Kostas Tsarhopoulos<sup>2</sup>, Frans Schoutsen<sup>3</sup>

<sup>1</sup>Engene SA, Athens, Greece; <sup>2</sup>RigasLabs SA, Thessaloniki, Greece; <sup>3</sup>Thermo Fisher Scientific, Breda, The Netherlands

## Key Words

TSQ Quantum Access MAX, Divert Valve, Split Peaks, Reversed-Phase Liquid Chromatography, Pesticides

## Goal

To demonstrate the ability to override the solvent effects from a sample extract using gradient solvents with liquid chromatography. Additionally, to increase injection volume without overloading the column.

## Introduction

Many pesticide analyses are based on the QuEChERS extraction method, which uses acetonitrile (ACN) in the final extraction step. However, injecting a solvent stronger than the HPLC mobile phase can cause peak shape problems, such as peak splitting or broadening, especially for the early eluting analytes (low capacity factor,  $k$ ). The common practice is to exchange the solvent of the final extraction step for one similar to the mobile phase, for example methanol / water, but this procedure is laborious and can lead to analyte losses.

There are several possible causes of peak splitting or broadening. This study presents the peak shape differences between acetonitrile and methanol / water [1:1 v/v] solutions due to the interaction of gradient and sample solvent, as indicated in Figure 1. The lowest detection limit is achieved when an analyte is in as compact a band as possible within the flow stream of mobile phase and with larger injection volumes. However, this is limited by maximum loop volume and column capacity.

Mobile phase composition and the use of a divert valve have been evaluated for the analysis of seven selected pesticides in acetonitrile solutions (Table 1). The sample solutions were chosen to represent both low and high analyte levels for compounds that elute either early or middle-early from a C18 column. Performance was evaluated in terms of linearity (injection volume range 1–8  $\mu$ L), robustness (RSD), and sensitivity as measured by signal-to-noise ratio (S/N) and peak area reproducibility.

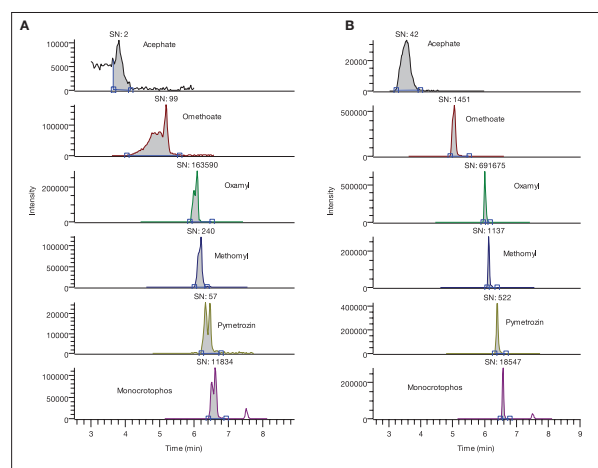

Figure 1. Chromatograms of 5  $\mu$ L injections of acephate, omethoate, oxamyl, methomyl, pymetrozin, and monocrotophos in 50  $\mu$ g/L acetonitrile (A) and methanol / water [1:1 v/v] solution (B), with no divert valve used



Table 1. List of studied pesticides and their physicochemical properties

Name	Pesticide Class	Chemical Formula	Water Solubility [mg/L] / pKow	Vapor Pressure [Pa]	Molecular Weight [g/mol]
Acephate	Organophosphorous	C <sub>4</sub> H <sub>10</sub> NO <sub>3</sub> PS	790,000 / -0.85	2.26 x 10 <sup>-4</sup> (24 °C)	183.165862
Aldicarb sulfone	Oxime carbamate	C <sub>7</sub> H <sub>14</sub> N <sub>2</sub> O <sub>4</sub> S	10,000 (25 °C) / -0.57 (calculated)	0.012 (25 °C)	222.26206
Metamitron	Triazinone	C <sub>10</sub> H <sub>10</sub> N <sub>4</sub> O	1770 (25 °C; pH 5) / 0.85 (21 °C, not pH dependent)	7.44 x 10 <sup>-7</sup> (25 °C)	202.2126
Methomyl	Oxime carbamate	C <sub>5</sub> H <sub>10</sub> N <sub>2</sub> O <sub>2</sub> S	55,000 (25 °C, pH 7) / 0.09 (25 °C, pH 4-10)	7.2 x 10 <sup>-4</sup> (25 °C)	162.210100
Monocrotophos	Organophosphorous	C <sub>7</sub> H <sub>14</sub> NO <sub>5</sub> P	water miscible	2.9 x 10 <sup>-4</sup> (20 °C)	223.163522
Omethoate	Organophosphorous	C <sub>5</sub> H <sub>12</sub> NO <sub>4</sub> PS	water-miscible / -0.74 (20 °C)	3.3 x 10 <sup>-3</sup> (20 °C)	213.191842
Oxamyl	Oxime carbamate	C <sub>7</sub> H <sub>13</sub> N <sub>3</sub> O <sub>3</sub> S	148,100 (20 °C, pH 5) / -0.44 (25 °C, pH 5)	5.12 x 10 <sup>-5</sup> (25 °C)	219.26142

## Experimental Conditions

### Sample Preparation

Individual stock solutions of pesticides were prepared at concentrations that were sufficient to evaluate the linearity of peak area versus injection volume at the same concentration e.g. 10 µg/L, but different injection volumes (e.g. 1, 2, 3, 4, 5, 6, 7 µL, etc.). Additional solutions with different concentrations (5, 10, 25, 50, 70, 100, 200 µg/L) were prepared to study the linearity of peak area versus compound concentration. Finally, solutions with different solvents (acetonitrile or methanol / water [1:1 v/v]) were prepared to study the solvent effect on the methanol / water gradient mobile phase during the injection.

### HPLC

HPLC analysis was performed using a Thermo Scientific Accela UHPLC system. The chromatographic conditions were as follows:

HPLC Column	Thermo Scientific Hypersil GOLD, 100 mm x 2.1 mm, 1.9 µm particle size
Trap Column	Hypersil™ GOLD, 10 mm x 2.1 mm, 5 µm particle size
Column Temperature	40 °C
Mobile Phase A	Water with ammonium formate (5 mM) and formic acid (2 mM)
Mobile Phase B	Methanol with ammonium formate (5 mM) and formic acid (2 mM)

The trap column was used to trap the analytes, while the divert valve was switched to the waste position. A tee union between the trap column and the analytical column was connected to the divert valve. The two positions of the divert valve are shown in Figure 2.

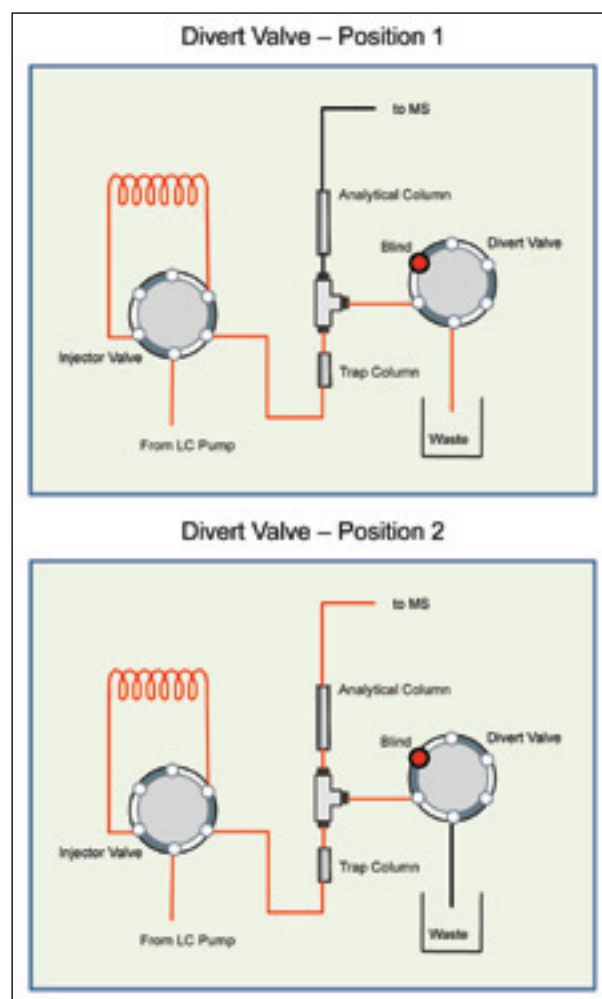

Figure 2. Divert valve positions

The gradient used is detailed in Table 2. The duration of the gradient was 21 minutes and the column equilibration time was 10 minutes. The flow rate increased at 21.10 min and decreased at 25.10 min to increase the speed of column equilibration for the next run (larger column volumes in less time). The maximum backpressure was 9,500 psi.



Table 2. HPLC Gradient. Mobile phase A is water with ammonium formate (5 mM) and formic acid (2 mM), and mobile phase B is methanol with ammonium formate (5 mM) and formic acid (2 mM).

No.	Time	A%	B%	$\mu\text{L}/\text{min}$
0	0.00	90.0	10.0	450.0
1	2.40	90.0	10.0	450.0
2	7.00	40.0	60.0	450.0
3	14.00	10.0	90.0	450.0
4	21.00	10.0	90.0	450.0
5	21.10	90.0	10.0	560.0
6	25.00	90.0	10.0	560.0
7	25.10	90.0	10.0	450.0
8	31.00	90.0	10.0	450.0

### Mass Spectrometry

MS analysis was carried out on a Thermo Scientific TSQ Quantum Access MAX triple stage quadrupole mass spectrometer with an electrospray ionization (ESI) probe. The MS conditions were as follows:

Ion polarity	Positive
Q1 Resolution	0.7 Da
Spray Voltage	4000 V
Sheath/Auxiliary Gas	Nitrogen
Sheath Gas Pressure	40 (arbitrary units)
Auxiliary Gas Pressure	25 (arbitrary units)
Ion Transfer Tube Temperature	325 °C
Scan Type	Selected-Reaction Monitoring (SRM)
Collision Gas	Argon
Collision Gas Pressure	1.5 mTorr
Divert Valve	Rheodyne® model 7750E-185

The divert valve was connected to the front of the TSQ Quantum Access MAX™ and was fully controlled from the data system software.

## Results and Discussion

The comparison of peak shapes between the acetonitrile and methanol / water sample solutions demonstrated that only early eluting analytes were altered by the mobile phase composition (Figure 3). Without the divert valve, the peak shape of omethoate, which elutes earlier than methomyl, was unacceptable in acetonitrile solution; whereas the peak shape of methomyl was better but not optimum (Figure 3a). The peak shape of metamitron, which elutes later than methomyl, was good in both acetonitrile and methanol / water sample solutions (Figures 3a, 3b). With the divert valve switched to the waste position for 1.30 minutes in the beginning of the run, the peak shapes of both omethoate and methomyl resembled those in the methanol / water sample solutions (Figure 3c).

The amount of time the valve was in the waste position affected the combination of peak shape and S/N ratio. As shown in Figure 4, the optimum combination of peak shape and RMS S/N ratio was achieved with a divert valve time of 1.30 minutes. Longer duration times were avoided, since the column equilibration was disturbed.

Figure 5 shows the range of injection volumes used. To assess the dependence between each compound peak area and the corresponding injection volume, eight injection volumes (1–8  $\mu\text{L}$ ) at a level of 10  $\mu\text{g}/\text{L}$  were run three times each. The linear correlation coefficients ( $R^2$  values) of the curve plots for all analytes studied were  $>0.99$ , and relative standard deviations were  $<20\%$  (range 1%–14%). A S/N ratio greater than 10 for acephate and omethoate could not be achieved for injection volumes of 1  $\mu\text{L}$  and 2  $\mu\text{L}$ .

Figure 6 shows the curve of each compound's peak area versus concentration for a 5  $\mu\text{L}$  injection volume. Seven different concentration levels (5, 10, 25, 50, 70, 100, 200  $\mu\text{g}/\text{L}$ ) with 5  $\mu\text{L}$  injection volumes were run three times. The linear correlation coefficients ( $R^2$  values) of the curve plots for all analytes studied were  $>0.99$  and relative standard deviations were  $<20\%$  (range 2%–16%). Using 5  $\mu\text{L}$  injections of 5  $\mu\text{g}/\text{L}$  acetonitrile solutions, RMS S/N ranged between 75 and 263,000.

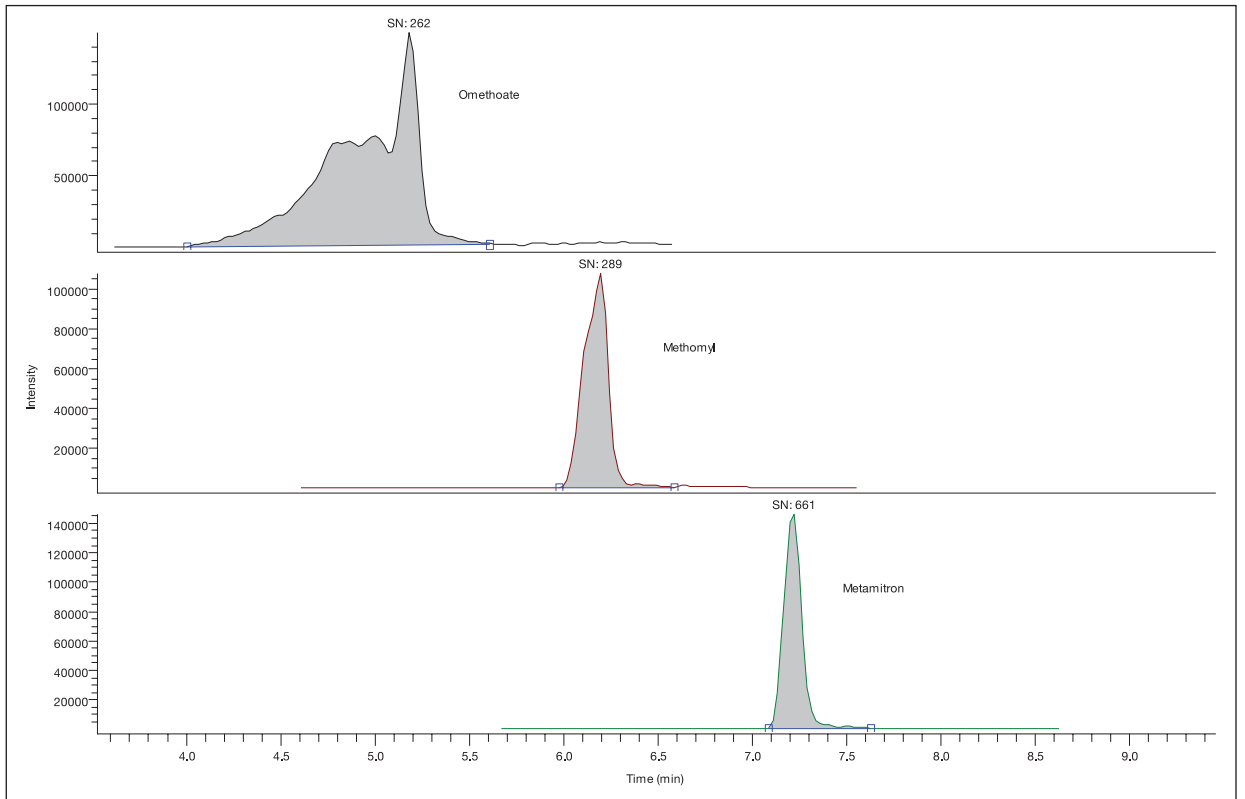

Figure 3a. Extracted chromatograms of 50 µg/L omethoate, methomyl, and metamitron in acetonitrile solution with no divert valve

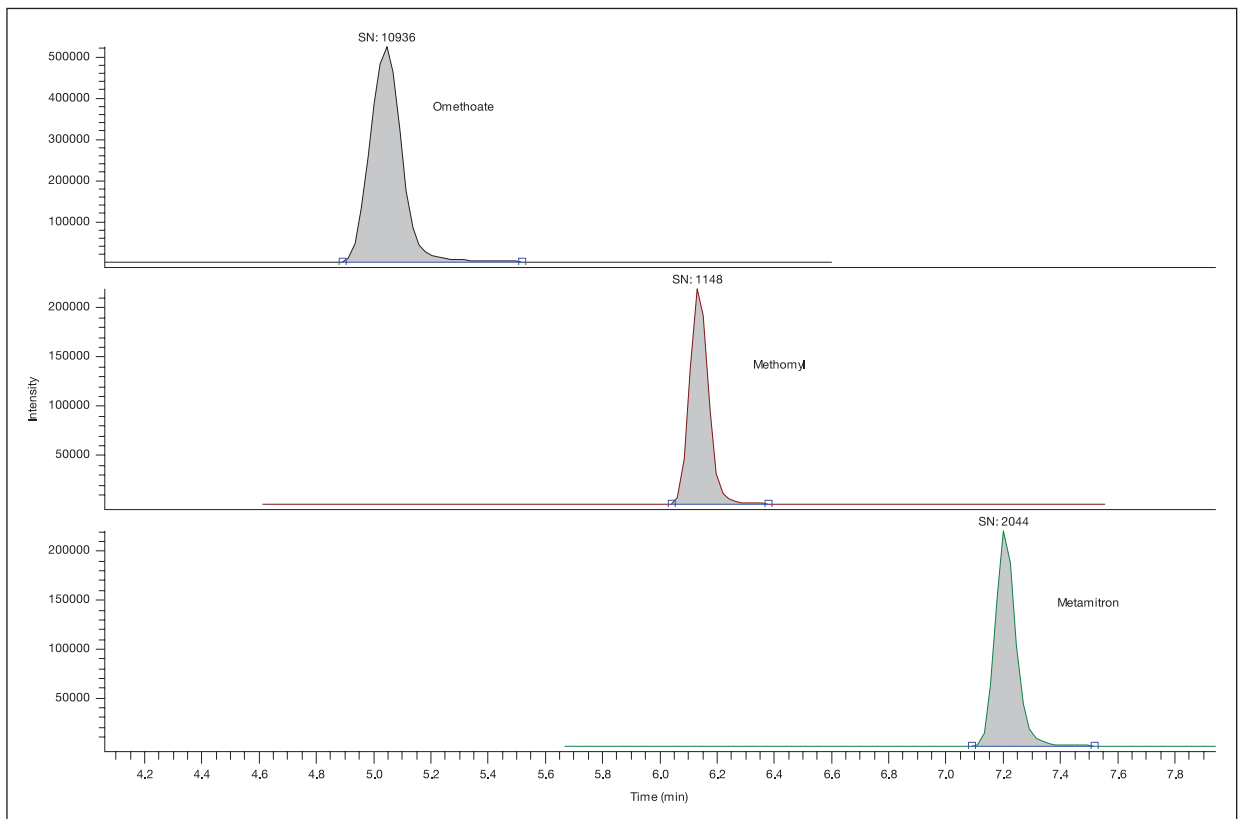

Figure 3b. Extracted chromatograms of 50 µg/L omethoate, methomyl, and metamitron in methanol / water [1:1 v/v] solution with no divert valve

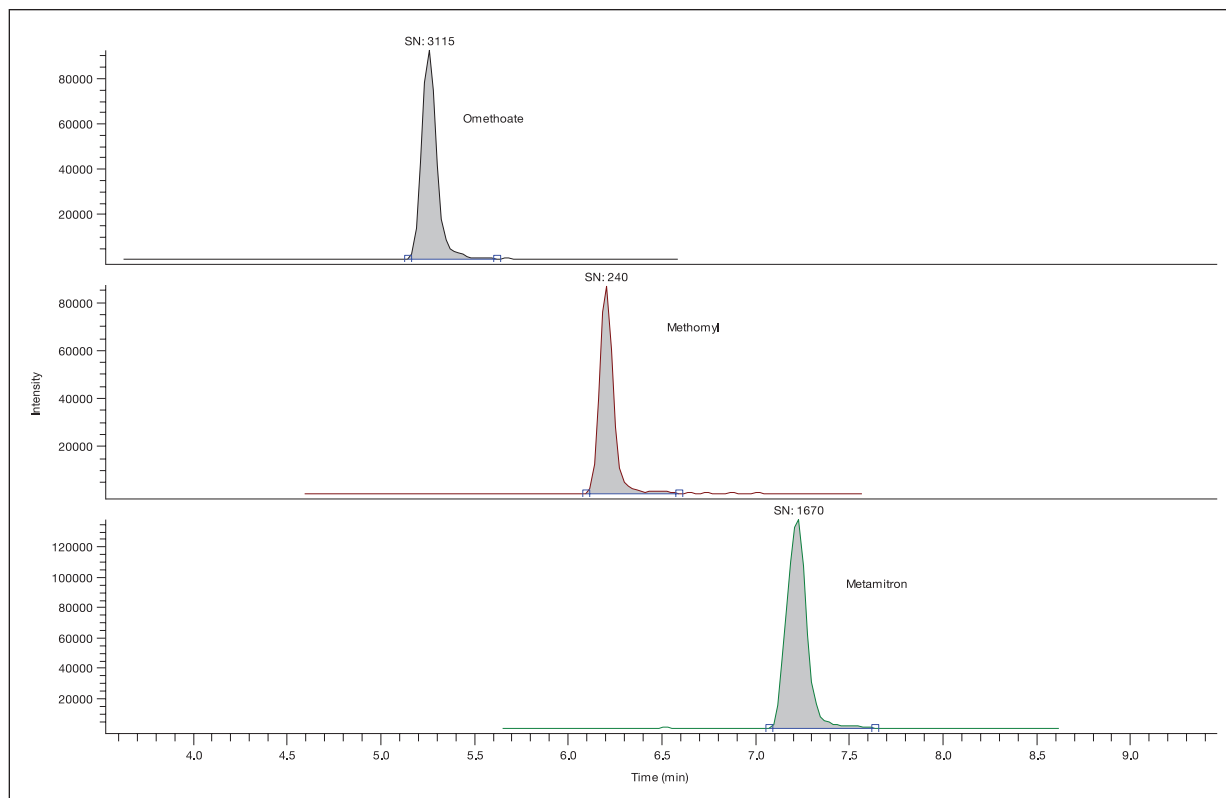

Figure 3c. Extracted chromatograms of 50  $\mu\text{g/L}$  omethoate, methomyl, and metamitron in acetonitrile solution with divert valve open for 1.30 minutes

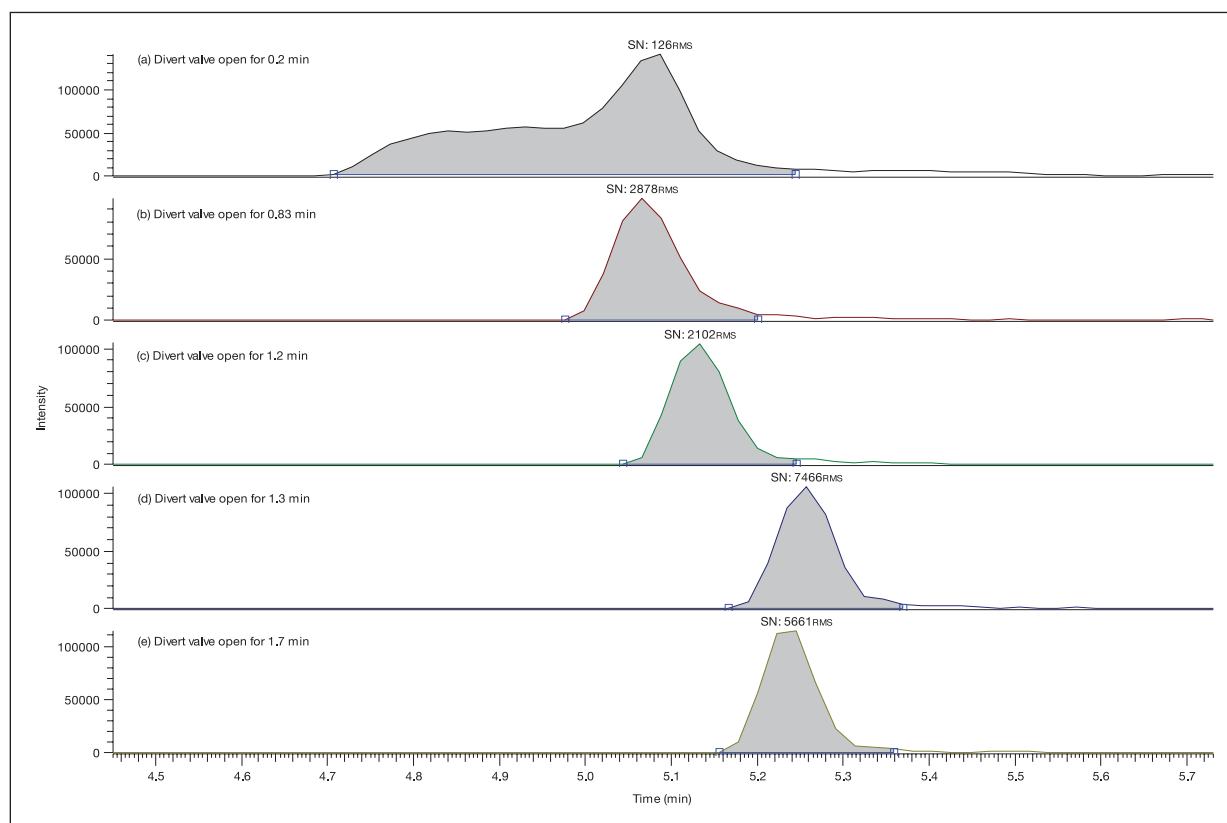

Figure 4. Extracted chromatograms of 5  $\mu\text{L}$  injections of omethoate in 50  $\mu\text{g/L}$  acetonitrile solution with various divert valve duration times used

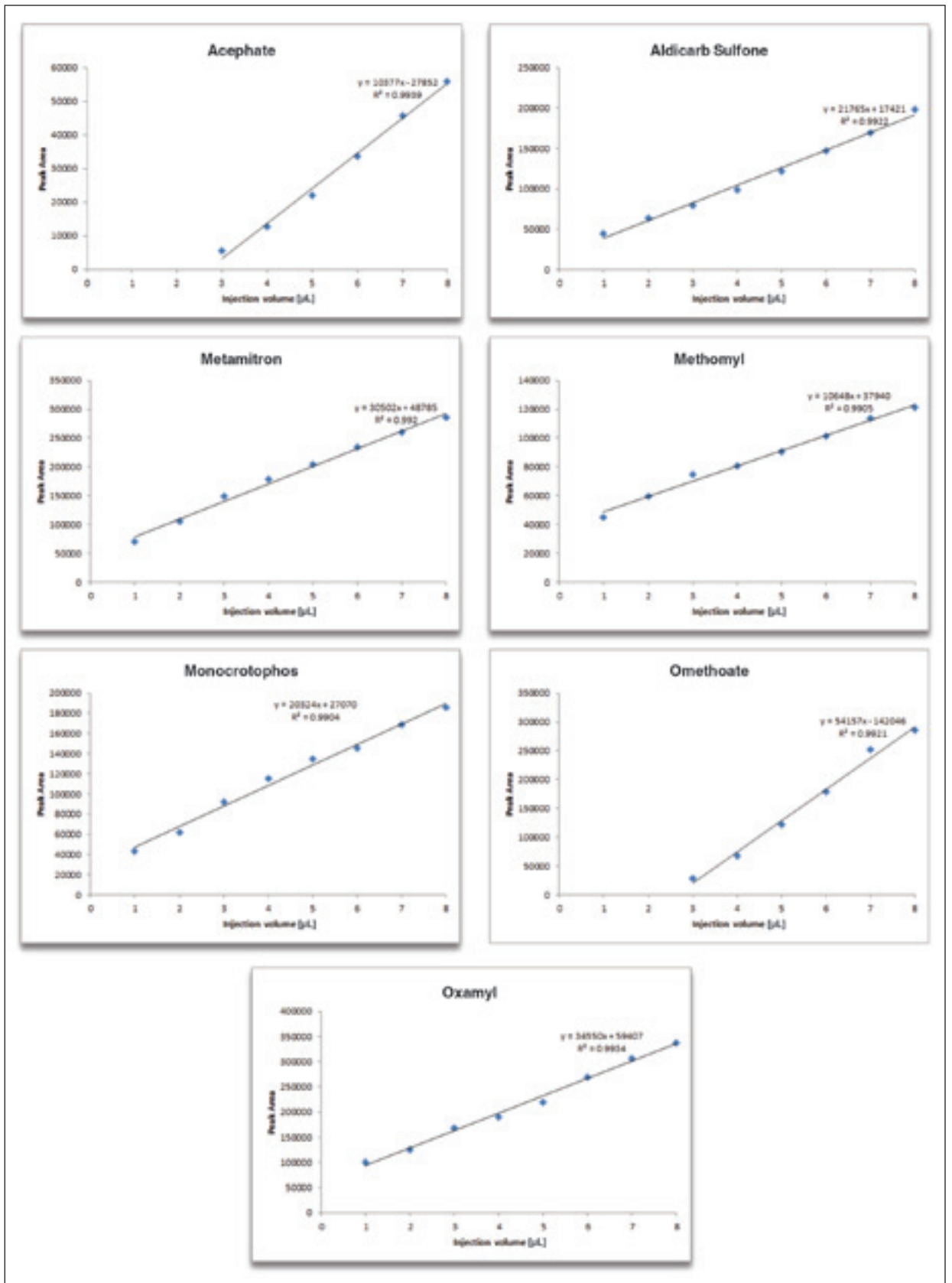

Figure 5. Curves for analyte peak area versus injection volumes 1-8 μL in 10 μg/L acetonitrile solution

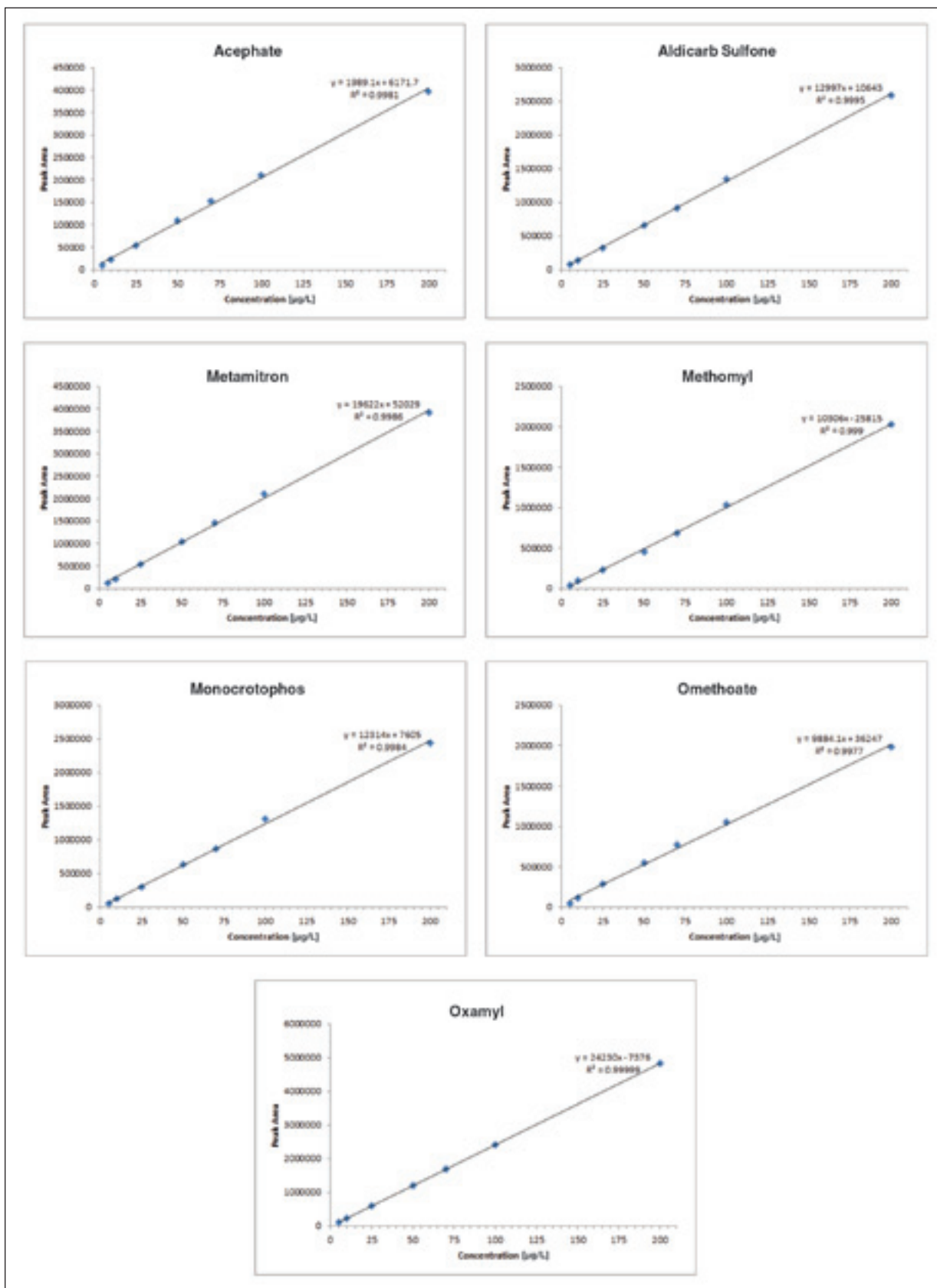

Figure 6. Curves for analyte peak area versus concentration 5-200 µg/L acetonitrile solution with 5 µL injection volume

## Conclusion

The use of a divert valve proved suitable for the analysis of early eluting pesticides in acetonitrile solutions. Good peak shapes and S/N ratios were achieved and chromatographic problems, such as peak splitting or broadening, were overcome. In addition, the injection volume was increased up to 8  $\mu\text{L}$ , reaching low detection limits with good linearity and repeatability, even for a sample concentration of 5  $\mu\text{g/L}$ . It may be possible to increase the injection volume to 10  $\mu\text{L}$ , and in some cases up to 15  $\mu\text{L}$ , but with a larger loop volume. After the initial experiments, we concluded that a 5  $\mu\text{L}$  injection volume is sufficient to achieve RMS S/N ratio greater than 10.

This technique resolves chromatographic issues involving interactions of gradient and sample solvent in a simple way and offers an increased laboratory sample capacity by avoiding solvent exchange in the final extract.

## Reference

1. Jake L. Rafferty, J. Ilja Siepmanna, Mark R. Schure  
*Journal of Chromatography A*, 2011, 1218, 2203–2213.

## [www.thermofisher.com](http://www.thermofisher.com)

©2016 Thermo Fisher Scientific Inc. All rights reserved. Rheodyne is a registered trademark of IDEX Health & Science LLC. All other trademarks are the property of Thermo Fisher Scientific Inc. and its subsidiaries. This information is presented as an example of the capabilities of Thermo Fisher Scientific Inc. products. It is not intended to encourage use of these products in any manners that might infringe the intellectual property rights of others. Specifications, terms and pricing are subject to change. Not all products are available in all countries. Please consult your local sales representative for details.

<b>Africa-Other</b> +27 11 570 1840	<b>Europe-Other</b> +43 1 333 50 34 0	<b>Japan</b> +81 45 453 9100	<b>Spain</b> +34 914 845 965
<b>Australia</b> +61 3 9757 4300	<b>Finland/Norway/Sweden</b> +46 8 556 468 00	<b>Latin America</b> +1 561 688 8700	<b>Switzerland</b> +41 61 716 77 00
<b>Austria</b> +43 1 333 50 34 0	<b>France</b> +33 1 60 92 48 00	<b>Middle East</b> +43 1 333 50 34 0	<b>UK</b> +44 1442 233555
<b>Belgium</b> +32 53 73 42 41	<b>Germany</b> +49 6103 408 1014	<b>Netherlands</b> +31 76 579 55 55	<b>USA</b> +1 800 532 4752
<b>Canada</b> +1 800 530 8447	<b>India</b> +91 22 6742 9434	<b>New Zealand</b> +64 9 980 6700	
<b>China</b> +86 10 8419 3588	<b>Italy</b> +39 02 950 591	<b>Russia/CIS</b> +43 1 333 50 34 0	
<b>Denmark</b> +45 70 23 62 60		<b>South Africa</b> +27 11 570 1840	



# Analysis of Regulated Pesticides in Drinking Water Using Accela and EQuan

Jonathan R. Beck and Charles Yang; Thermo Fisher Scientific, San Jose, CA

## Key Words

- TSQ Quantum™
- Accela™ LC System
- EQuan™
- LC-MS/MS
- Pesticide Analysis
- Water Analysis

## Introduction

Pesticides are used throughout the world to control pests that are harmful to crops, animals, or people. Because of the danger of pesticides to human health and the environment, regulatory agencies control their use and set pesticide residue tolerance levels. The limits of detection (LODs) for many of these substances are at the parts-per-trillion (ppt) level. In order to achieve this level of detection, offline sample pre-concentration is often performed. However, these sample preparation procedures can be time consuming, adding as much as one to two days to the total analysis time. Therefore, a method for online sample pre-concentration that bypasses the offline sample pre-concentration provides a significant time savings over conventional methods.

We describe a method for online sample cleanup and analysis using the EQuan system. This method couples a Fast-HPLC system with two Hypersil™ GOLD LC columns (Thermo Scientific, Bellefonte, PA)—one for pre-concentration of the sample, the second for the analytical separation—and an LC-MS/MS instrument. Large volumes of drinking water samples (1 mL) can be directly injected onto the loading column for LC-MS/MS analysis, thus eliminating the need for offline sample pre-concentration and saving overall analysis time. Using this configuration, run times of six minutes are achieved for the analysis of a mixture of pesticides. For separation prior to analysis using an LC-MS/MS instrument, Fast-HPLC allows for significantly shorter run times than conventional HPLC.

## Goal

To demonstrate the use of Fast-HPLC and a large volume injection to analyze sub-ppb concentrations of regulated pesticides in drinking water samples.

## Experimental Conditions

### Sample Preparation

Bottled drinking water was spiked with a mixture of the following pesticides: carbofuran, carbaryl, diuron, daimuron, bensulfuron-methyl, tricyclazole, azoxystrobin, halosulfuron-methyl, flazasulfuron, thiodicarb, and siduron. Concentrations were prepared at the following levels: 0.5, 1, 5, 10, 50, 100, 500, and 1000 pg/mL (ppt).

No other sample treatment was performed prior to injection. The mass transitions and collision energies for each compound are listed in Table 1.

## HPLC

Fast-HPLC analysis was performed using the Accela High Speed LC System (Thermo Scientific, San Jose, CA). A 1 mL water sample was injected directly onto a 20 mm × 2.1 mm ID, 12 μm Hypersil GOLD loading column in a high aqueous mobile phase at a flow rate of 1 mL/min (see Figure 1a). After approximately one minute, a 6-port valve on the mass spectrometer was switched via the instrument control software. This enabled the loading column to be back flushed onto the analytical column (Hypersil GOLD 50 × 2.1 mm ID, 1.9 μm), where the compounds were separated prior to introduction into the mass spectrometer (Figure 1b). After all of the compounds were eluted from the analytical column at a

Analyte	Precursor Mass (m/z)	Product Mass (m/z)	Collision Energy (eV)
Tricyclazole	190.09	106	10
Thiodicarb	355.06	88	14
Carbofuran	222.10	165	14
Carbaryl	202.14	145	10
Diuron	233.05	72	20
Bensulfuron-methyl	411.13	149	22
Flazasulfuron	408.08	182	24
Siduron	233.19	137	20
Azoxystrobin	404.16	372	15
Halosulfuron-methyl	435.11	182	24
Daimuron	269.21	151	14

Table 1: List of mass transitions and collision energies for each compound analyzed.

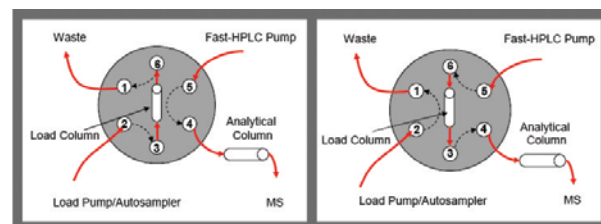

Figure 1a: 6-port valve position one (load position), for loading the sample onto the loading column.

Figure 1b: 6-port valve position two (inject position), for eluting the compounds trapped on the loading column onto the analytical column.

flow rate of 850  $\mu\text{L}/\text{min}$ , the 6-port valve was switched back to the starting position. The loading and analytical columns were cleaned with a high organic phase before being re-equilibrated to their starting conditions. The total run time for each analysis was six minutes. The mobile phases for the analysis were water and acetonitrile, both containing 0.1% formic acid. The gradient profile for each pump is shown in Figure 2.

The pressure at the beginning of the gradient was monitored. At a flow rate of 850  $\mu\text{L}/\text{min}$  (at the initial gradient conditions with the flow going through only the Hypersil GOLD 50 $\times$ 2.1 mm, 1.9  $\mu\text{m}$  column), the backpressure for the Fast-HPLC system was approximately 450 bar. For comparison, an earlier method which used a Hypersil GOLD 50 $\times$ 2.1 mm, 3  $\mu\text{m}$  column had a backpressure of approximately 150 bar at a flow rate of 200  $\mu\text{L}/\text{min}$ .

## MS

MS analysis was carried out on a TSQ Quantum Access triple stage quadrupole mass spectrometer with a heated electrospray ionization (H-ESI) probe (Thermo Scientific, San Jose, CA). The MS conditions were as follows:

Ion source polarity: Positive ion mode

Spray voltage: 4000 V

Vaporizer temperature: 450  $^{\circ}\text{C}$

Sheath gas pressure ( $\text{N}_2$ ): 50 units

Auxiliary gas pressure ( $\text{N}_2$ ): 50 units

Ion transfer tube temperature: 380  $^{\circ}\text{C}$

Collision Gas (Ar): 1.0 mTorr

Q1/Q3 Peak Resolution: 0.7 u

Scan Width: 0.002 u

## Results and Discussion

Chromatograms for the calibration standard at a concentration of 500  $\text{pg}/\text{mL}$  are shown in Figure 3. In the Fast-HPLC run, all 11 of the individual analytes were eluted before three minutes. In contrast, none of the analytes in the standard HPLC run were eluted until nearly eight minutes into the run. Further optimization of the chromatography for the Fast-HPLC would produce even shorter run times.

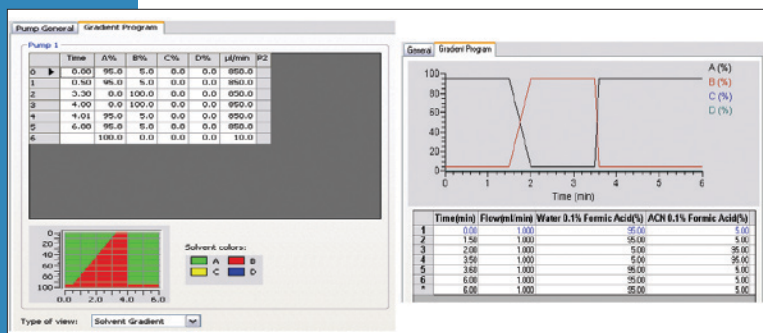

Figure 2: Gradient profiles for the two LC pumps used in this experiment. The Fast-HPLC pump gradient is shown on the left, and the loading pump gradient is shown on the right.

Calibration curves for all 11 compounds were generated using LCQUAN<sup>TM</sup> 2.5 software (Thermo Scientific, San Jose, CA). Excellent linearity was achieved for all of the compounds analyzed in this experiment. Figure 4 shows a representative calibration curve for the compound azoxystrobin over the concentration range 0.5 to 1000  $\text{pg}/\text{mL}$  (ppt). The calibration curve fit parameters and the limits of detection for the analytes are summarized in Table 2. The final column in the table lists the Minimum Performance Reporting Limit (MPRL) for these compounds as set by the Japanese Ministry of Health, Labour, and Welfare<sup>1</sup>. All of the compounds were detected and quantified at levels well below these regulatory requirements.

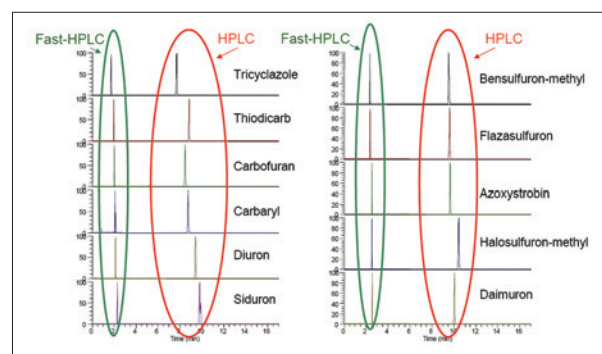

Figure 3: Chromatograms showing the SRMs for each of the components in the mixture. Two different HPLC conditions are shown: the Fast-HPLC run and the standard HPLC run. All compounds in the Fast-HPLC run are eluted in less than three minutes (circled in green). Those in the standard HPLC run are eluted much later (circled in red). These chromatograms represent a calibration level of 500  $\text{pg}/\text{mL}$  (ppt).

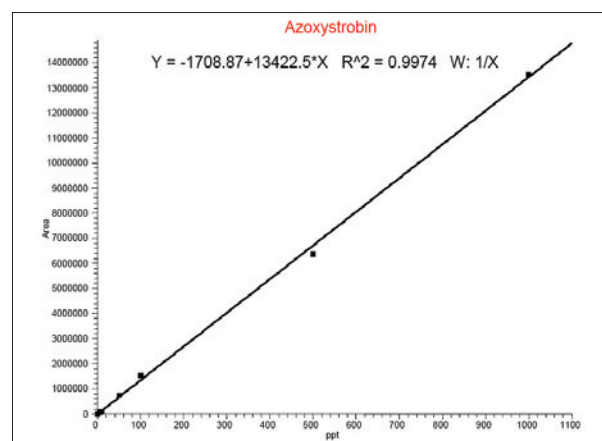

Figure 4: Calibration curve for the compound azoxystrobin. This calibration curve covers the range from 0.5 to 1000  $\text{pg}/\text{mL}$  (ppt)

Analyte	R <sup>2</sup>	Limit of Detection (ppt)	MPRL (ppt)
Tricyclazole	0.9972	0.5	800
Thiodicarb	0.9930	5	800
Carbofuran	0.9928	1	50
Carbaryl	0.9345	100	500
Diuron	0.9978	100	200
Bensulfuron-methyl	0.9933	0.5	4000
Flazasulfuron	0.9944	1	300
Siduron	0.9973	0.5	3000
Azoxystrobin	0.9974	0.5	5000

Table 2: List of calibration curve fit parameters, limits of detection, and Minimum Performance Reporting Levels (MPRL) for each compound from the Japanese Ministry of Health, Labour and Welfare. All calibrations were carried out using a linear curve fit and a weighting factor of 1/X.

## Conclusion

The implementation of Fast-HPLC, coupled with the online pre-concentration and sample preparation technique EQuan, yielded analysis of 11 pesticides in drinking water in less than one-third the time of conventional HPLC analysis. All of the compounds eluted within three minutes, which included a one-minute loading time for the sample to be pre-concentrated on the loading column. The total run time for the analysis was six minutes. The Fast-HPLC method can be further shortened to produce faster chromatographic run times.

The use of large volume injections achieved results below the MPRL regulatory requirements for each of the 11 pesticides. Because the limits of detection were much lower than the MPRL values, the integrated peaks yielded excellent signal-to-noise ratios and allowed for confidence in reporting the results.

## Reference

- <sup>1</sup> <http://www.mhlw.go.jp/index.html> (Japanese language version),  
<http://www.mhlw.go.jp/english/index.html> (English language version)

## Laboratory Solutions Backed by Worldwide Service and Support

Tap our expertise throughout the life of your instrument. Thermo Scientific Services extends its support throughout our worldwide network of highly trained and certified engineers who are experts in laboratory technologies and applications. Put our team of experts to work for you in a range of disciplines – from system installation, training and technical support, to complete asset management and regulatory compliance consulting. Improve your productivity and lower the cost of instrument ownership through our product support services. Maximize uptime while eliminating the uncontrollable cost of unplanned maintenance and repairs. When it's time to enhance your system, we also offer certified parts and a range of accessories and consumables suited to your application.

To learn more about our products and comprehensive service offerings, visit us at [www.thermo.com](http://www.thermo.com).

In addition to these offices, Thermo Fisher Scientific maintains a network of representative organizations throughout the world.

**Australia**  
+61 2 8844 9500  
**Austria**  
+43 1 333 50340  
**Belgium**  
+32 2 482 30 30  
**Canada**  
+1 800 532 4752  
**China**  
+86 10 5850 3588  
**Denmark**  
+45 70 23 62 60  
**France**  
+33 1 60 92 48 00  
**Germany**  
+49 6103 408 1014  
**India**  
+91 22 6742 9434  
**Italy**  
+39 02 950 591  
**Japan**  
+81 45 453 9100  
**Latin America**  
+1 608 276 5659  
**Netherlands**  
+31 76 587 98 88  
**South Africa**  
+27 11 570 1840  
**Spain**  
+34 91 657 4930  
**Sweden/Norway/  
Finland**  
+46 8 556 468 00  
**Switzerland**  
+41 61 48784 00  
**UK**  
+44 1442 233555  
**USA**  
+1 800 532 4752

[www.thermo.com](http://www.thermo.com)

### Legal Notices

©20016 Thermo Fisher Scientific Inc. All rights reserved. All other trademarks are the property of Thermo Fisher Scientific Inc. and its subsidiaries. This information is presented as an example of the capabilities of Thermo Fisher Scientific Inc. products. It is not intended to encourage use of these products in any manners that might infringe the intellectual property rights of others. Specifications, terms and pricing are subject to change. Not all products are available in all countries. Please consult your local sales representative for details.

View additional Thermo Scientific LC/MS application notes at: [www.thermo.com/appnotes](http://www.thermo.com/appnotes)

AN62449\_E 80/16S

# Analysis of Triazine Herbicides in Drinking Water Using LC-MS/MS and TraceFinder Software

Jonathan R. Beck, Jamie K. Humphries, Louis Maljers, Kristi Akervik, Charles Yang, Dipankar Ghosh  
Thermo Fisher Scientific, San Jose, CA

## Introduction

Thermo Scientific TraceFinder software includes built-in workflows for streamlining routine analyses in environmental and food safety laboratories. By incorporating a database of liquid chromatography-mass spectrometry (LC/MS) methods that can be customized to include unique compounds, TraceFinder™ allows the analyst to access commonly encountered contaminants found in the environment. To demonstrate the capabilities of this software, a mixture of triazine compounds spiked into drinking water samples was analyzed. Using direct injections of 20 mL samples (with on-line preconcentration), low- and sub-pg/mL (ppt) levels were detected. The ability to analyze these drinking water samples with on-line preconcentration saves considerable time and expense compared to solid phase extraction techniques.

## Goal

To demonstrate the ease-of-use of TraceFinder software for the analysis of triazine herbicides in water samples.

## Experimental Conditions

### Sample Preparation

Water with 0.1% formic acid was spiked with a mixture of triazines ranging from 0.1 pg/mL to 10.0 pg/mL. The following triazines were used: ametryn, atraton, atrazine, prometon, prometryn, propazine, secbumeton, simazine, simetryn, terbutryn, and terbuthylazine (Ultra Scientific, North Kingstown, RI).

### HPLC

HPLC analysis was performed using the Thermo Scientific Surveyor Plus LC pump for loading the samples and a Thermo Scientific Accela UHPLC pump for the elution of the compounds. The autosampler was an HTC-Pal Autosampler (CTC Analytics, Zwingen, Switzerland) equipped with a 20 mL loop.

Sequential 5 mL syringe fills were used to load the 20 mL loop in 4 steps by using a custom CTC macro. Using the Thermo Scientific Equan online sample enrichment system, 20 mL samples of spiked water, commercial bottled water, diet soda, and blanks (reagent water) were injected directly onto a loading column (Thermo Scientific Hypersil GOLD 20 × 2.1 mm, 12 μm).

After an appropriate time, depending on the volume injected, a multi-port valve was switched to enable the loading column to be back-flushed onto the analytical column (Hypersil GOLD™ 50 × 2.1 mm, 3 μm), where the compounds were separated prior to introduction into a triple stage quadrupole mass spectrometer. After all of the compounds were eluted, the valve was switched back to the starting position. The loading column and the analytical column were cleaned with a high organic mobile phase and equilibrated.

### MS

MS analysis was carried out on a Thermo Scientific TSQ Quantum Access MAX triple stage quadrupole mass spectrometer with an electrospray ionization (ESI) source. The MS conditions were as follows:

Ion source polarity:	Positive ion mode
Spray voltage:	4000 V
Sheath gas pressure (N <sub>2</sub> ):	30 units
Auxiliary gas pressure (N <sub>2</sub> ):	5 units
Ion transfer tube temperature:	380 °C
Collision gas (Ar):	1.5 mTorr
Q1/Q3 Peak resolution:	0.7 Da
Scan width:	0.002 Da

### Software

Data collection and processing was handled by TraceFinder software. TraceFinder includes methods applicable to the environmental and food safety markets, as well as a comprehensive Compound Datastore (CDS). The CDS includes selective reaction monitoring (SRM) transitions and collision energies for several hundred pesticides, herbicides, personal care products, and pharmaceutical compounds that are of interest to the environmental and food safety fields. A user can select one of the included methods in TraceFinder, or quickly develop new or modified methods by using the pre-existing SRM transition information in the CDS, thus eliminating time-consuming compound optimizations.

## Key Words

- TSQ Quantum Access MAX
- TraceFinder software
- Water analysis
- Environmental

## Results and Discussion

The analyst can select in which area to begin working (Figure 1). In this application note, the entire process will be illustrated, from method development to reporting.

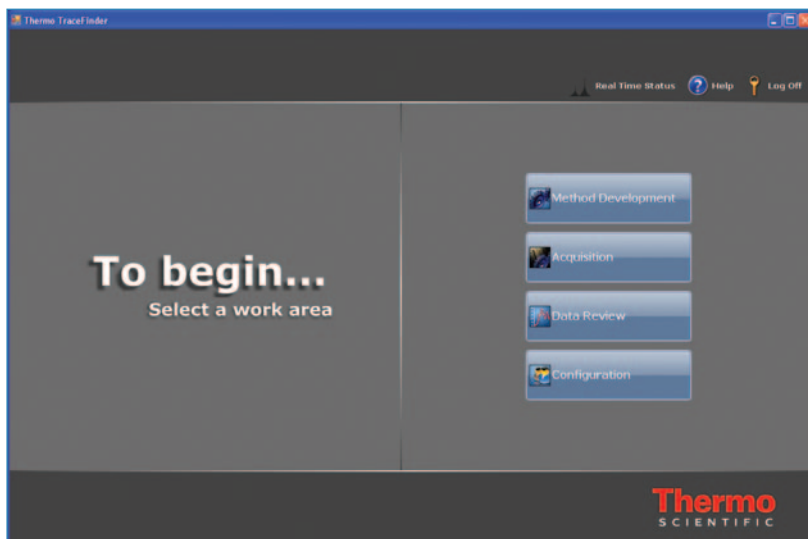

Figure 1. TraceFinder Welcome screen

## Method Development

The Method Development section of the software allows the user to select the compounds that will be analyzed in the method. In this experiment, the appropriate SRM transitions for the triazine mixture were chosen from the CDS and inserted into the method for detection (Figure 2). No compound optimization is necessary for compounds already in the data store.

Additionally, the calibration standards, QC levels, and

peak detection settings are defined in the Method Development section. Results can be flagged based on user-defined criteria. For example, the user can set a flag for a compound whose calculated concentration is beyond the upper limit of linearity, above a defined reporting limit, or below a limit of detection. This allows for faster data review after collection, and quick identification of positive samples. Full support for qualifier SRM ion ratios is also included but was not used in this experiment.

## Acquisition

The Acquisition section provides a step-by-step process to acquire data. The progress is followed in an overview section on the left side of the screen (Figure 3). A green checkbox indicates that the step has been completed and there are no errors. The steps include template selection (pre-defined sample lists, which are helpful in routine analysis), method selection, sample list

definition, report selection, and instrument status. Figure 3 shows calibrators, blanks, replicate “unknowns” of a 1 pg/mL sample, and drinking water samples for this experiment.

A final status page summarizes the method and all of the samples to be run and gives an overall summary of the status of the instrument (Figure 4). Three color-coded dots are shown: green indicates an ‘ok’ status; yellow indicates the instrument module is in standby; and red indicates the

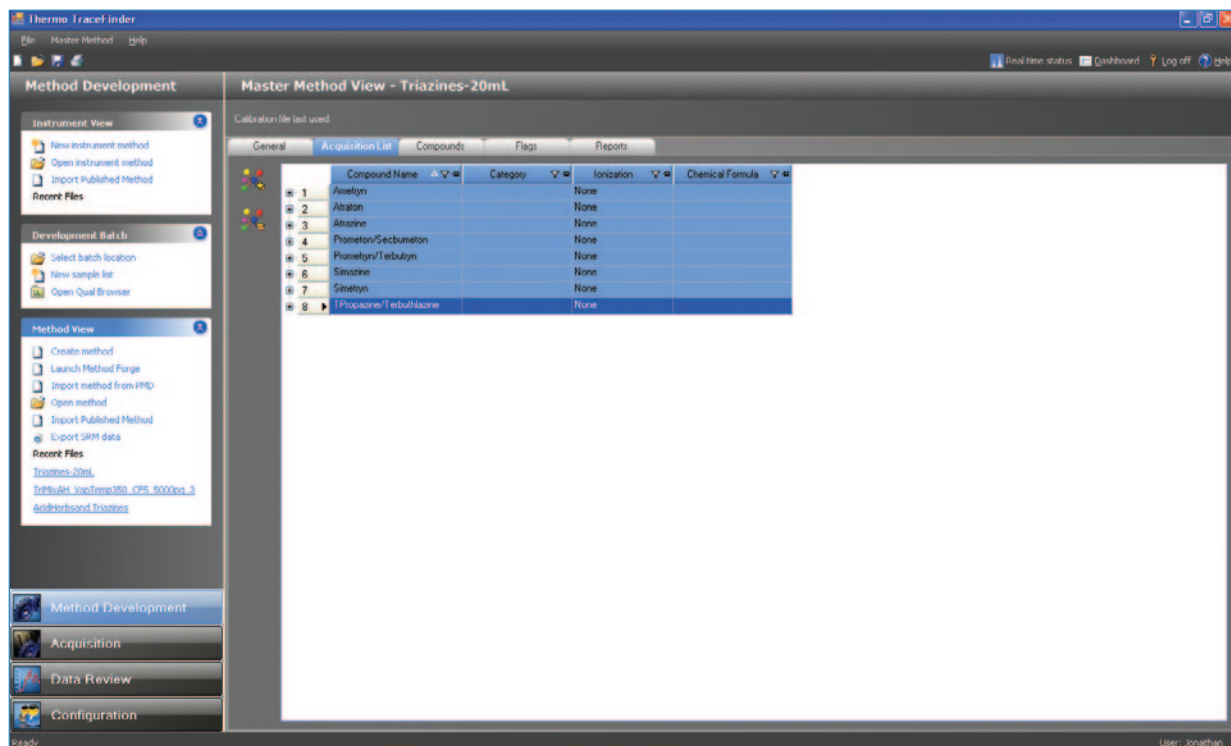

Figure 2. Master Method View, showing the triazine compounds that will be monitored in this method.



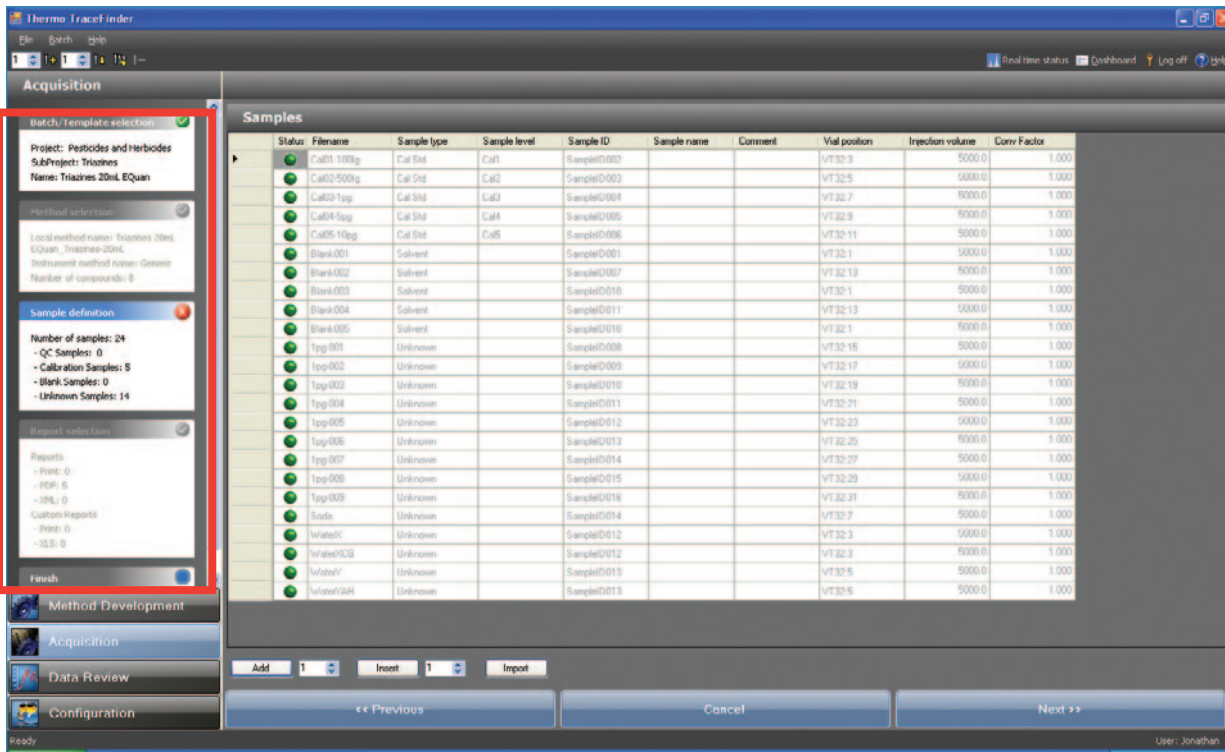

Figure 3. Acquisition section with the sample list being defined. The red box at left outlines the overall progress.

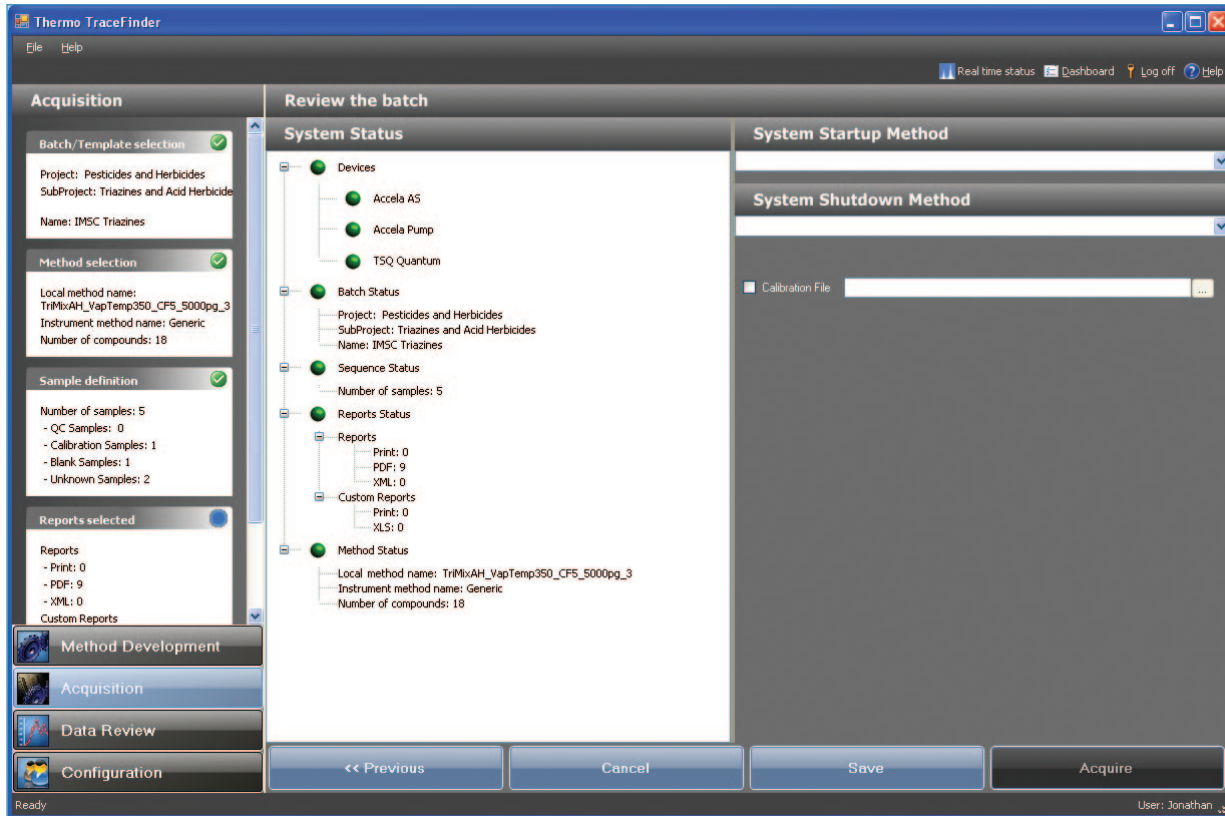

Figure 4. Acquisition status section. This is the final view before submitting a batch for analysis, providing the user instant instrument and method feedback.



instrument module is either off or disconnected. From the final status page, the batch can be acquired or saved to be run at a later date. A previously saved calibration curve can be used, so that a calibration need not be run every day. For example, the save function can be used to prepare for future batches in advance of sample preparation. When the samples are ready to be run, the previously saved batch is loaded and acquisition is begun.

## Data Review

The targeted analysis of triazine compounds in drinking water samples was reviewed in the Data Review section of TraceFinder. In this section, calibration lines, ion ratios, peak integration, and mass spectra (if applicable) can be monitored. In addition, the Data Review section can flag samples that meet certain user-set criteria. For example, a limit can be set on the  $R^2$  value of a calibration line. A green flag means that all user-set criteria have been met, while a red flag indicates that the sample exceeds or fails some user-set criteria and a yellow flag indicates that the compound was not found in the sample. Flags can also be used to highlight “positive” or “negative” hits in a sample. Figure 5 illustrates the red flags indicating the absence of peaks in blank samples for the compound simazine at its lowest calibration level, 100 fg/mL. In addition, flags can be set to alert for the presence of carryover in blank samples. In this study, 20 mL injections

of the calibration standards, even at the highest level, resulted in no detectable carryover.

The Data Review pane allows user adjustments, such as peak reintegration. The effects of the changes on the results are instantly updated in the results grid. Excellent linearity was observed for all analytes, with  $R^2$  values ranging from 0.9921 for atrazine to 0.9995 for propazine and terbuthlazine (co-eluting isomers, summed together for this analysis).

As mentioned previously, no carryover was observed in the blank samples, which illustrates the ability to use a single loading column for multiple analyses of drinking water samples. No triazines were detected in the soda sample, but one of the commercial drinking water samples tested positive for atrazine. The concentration of atrazine in the sample was calculated to be 0.24 pg/mL, well below the regulatory levels in the United States and Europe. However, using standard injection techniques without sample preconcentration, it is unlikely that this amount of atrazine would be detected in a typical LC-MS/MS analysis of triazines.

In addition to 20 mL injections, 1 mL and 5 mL injections were analyzed in a separate experiment. The %RSDs for replicate injections, without internal standards, at 20 mL are shown with all of the compounds in Table 1.



Figure 5. Data Review section. The red flags for blank samples indicate that peaks were not found in these samples.

Table 1. Reproducibility and peak area enhancement for 1, 5, and 20 mL injections for the mixture of triazines at the 1 pg/mL level (n=20).

Compound	Area, 1 mL	Area, 5 mL	Area, 20 mL	Factor 1 mL to 5 mL	Factor 5 mL to 20 mL	%RSD (n = 8)
Atraton	ND	1.16E+07	5.42E+07	N/A	4.69	11.15
Simetryn	ND	4.27E+06	1.94E+07	N/A	4.56	8.93
Prometon/Secbumeton	3.26E+06	1.07E+07	4.80E+07	3.30	4.47	9.89
Ametryn	4.34E+06	1.42E+07	5.99E+07	3.27	4.22	11.59
Simazine	3.18E+05	1.28E+06	5.70E+06	4.03	4.44	5.32
Prometryn/Terbutryn	6.19E+06	1.89E+07	7.61E+07	3.05	4.02	3.99
Atrazine	1.26E+06	4.45E+06	1.55E+07	3.53	3.49	4.97

## Reporting

A large number of customizable report templates are included in TraceFinder. The user has the option of creating PDF reports, printing reports directly to the printer, or saving reports in an XML format, which is useful for LIMS systems. In each method, the user can decide which reports are most applicable to a given method. In this manner, a supervisor or lab director can set up methods and reports, lock the method, and make it non-editable by technicians. In this way, the integrity of a method is preserved, which is especially useful in controlled environments.

An example of one of the reports generated by TraceFinder is shown in Figure 6. This view shows the on-screen preview function available in TraceFinder. The chromatogram shown is for a 1 pg/mL “unknown” spiked water sample. The quantitated results follow beneath the chromatogram. At the very top of the page is a sample summary. TraceFinder can generate results for the entire batch with the click of a button, or the user can choose to view reports individually and print only those of interest.

## Conclusion

In this application note, TraceFinder software was used in conjunction with an online preconcentration system, Equan™, for the robust and reproducible analysis of large volumes of drinking water. Triazines were quantitated at the sub-ppt level, and several commercial bottled drinking water samples and one sugar-free soda sample were analyzed for the presence of triazines. Only one sample contained any traces of triazines: a commercial drinking water sample tested positive for atrazine. TraceFinder can also be used for traditional LC/MS applications, minimizing method development time. The method development capabilities and Compound Datastore of TraceFinder allowed for the quick creation of a method for the analysis of these compounds.

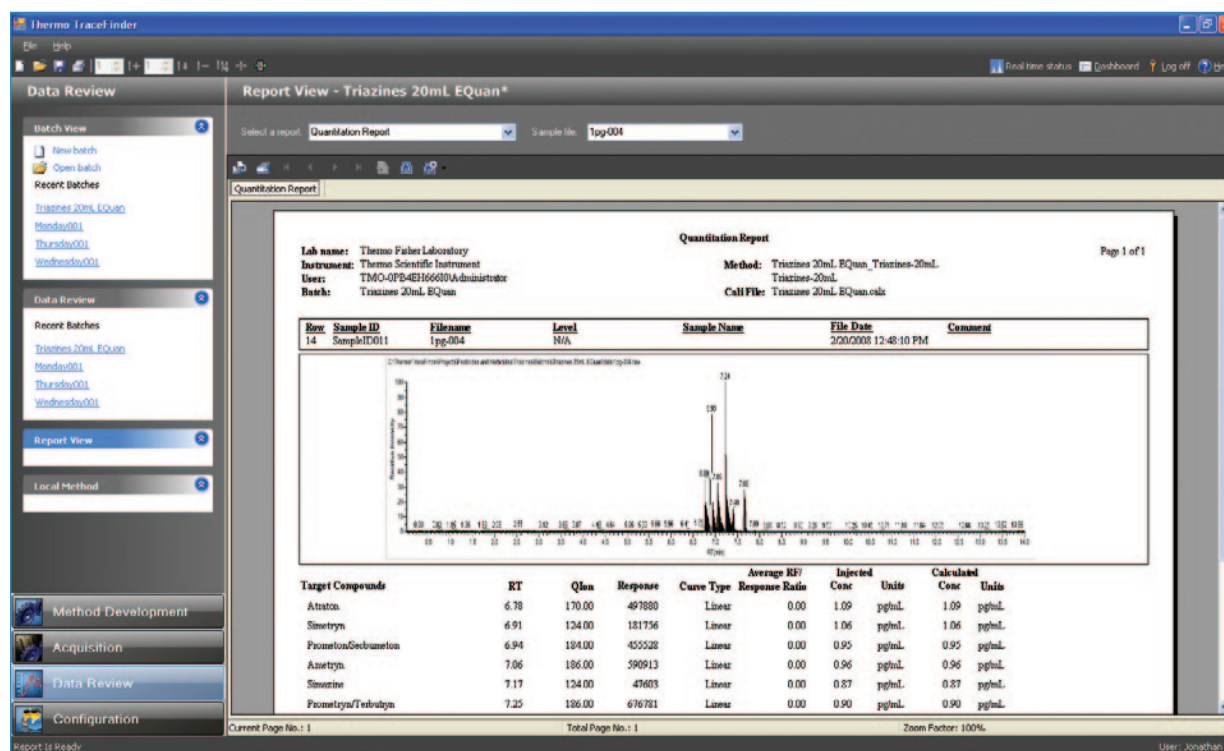

Figure 6. Report View section. In this report preview, the results of a water sample spiked with 1 pg/mL of the triazine mixture are shown.

*In addition to these offices, Thermo Fisher Scientific maintains a network of representative organizations throughout the world.*

**Africa-Other**  
+27 11 570 1840

**Australia**  
+61 2 8844 9500

**Austria**  
+43 1 333 50 34 0

**Belgium**  
+32 2 482 30 30

**Canada**  
+1 800 530 8447

**China**  
+86 10 8419 3588

**Denmark**  
+45 70 23 62 60

**Europe-Other**  
+43 1 333 50 34 0

**Finland/Norway/  
Sweden**  
+46 8 556 468 00

**France**  
+33 1 60 92 48 00

**Germany**  
+49 6103 408 1014

**India**  
+91 22 6742 9434

**Italy**  
+39 02 950 591

**Japan**  
+81 45 453 9100

**Latin America**  
+1 608 276 5659

**Middle East**  
+43 1 333 50 34 0

**Netherlands**  
+31 76 579 55 55

**South Africa**  
+27 11 570 1840

**Spain**  
+34 914 845 965

**Switzerland**  
+41 61 716 77 00

**UK**  
+44 1442 233555

**USA**  
+1 800 532 4752

**[www.thermo.com](http://www.thermo.com)**

#### Legal Notices

©2016 Thermo Fisher Scientific Inc. All rights reserved. CTC is a trademark of CTC Analytics, Zwingen, Switzerland. All other trademarks are the property of Thermo Fisher Scientific and its subsidiaries. All other trademarks are the property of Thermo Fisher Scientific Inc. and its subsidiaries. This information is presented as an example of the capabilities of Thermo Fisher Scientific Inc. products. It is not intended to encourage use of these products in any manners that might infringe the intellectual property rights of others. Specifications, terms and pricing are subject to change. Not all products are available in all countries. Please consult your local sales representative for details.

**View additional Thermo Scientific LC/MS application notes at: [www.thermo.com/appnotes](http://www.thermo.com/appnotes)**

AN63184\_E 08/16S

# Analysis of Triazine Pesticides in Drinking Water Using LC-MS/MS (EPA Method 536.0)

Jonathan Beck, Thermo Fisher Scientific, San Jose, CA, USA

## Key Words

- Drinking Water Analysis
- Herbicides
- Hypersil GOLD Columns
- Triazines
- TSQ Quantum Access

## Introduction

The US EPA has recently issued a draft form of a proposed method for the analysis of triazine compounds in drinking water.<sup>1</sup> This method uses a simple method to directly analyze triazine compounds using LC-MS/MS without requiring any solid phase extraction (SPE) or other lengthy sample preparation steps. This application note demonstrates the analysis of these compounds over the concentration range 0.25 – 5.0 ng/mL (ppb) using the Thermo Scientific TSQ Quantum Access™ triple stage quadrupole mass spectrometer and the Thermo Scientific Accela™ HPLC system.

## Experimental Conditions

The following triazine and triazine degradates were analyzed: Atrazine, Atrazine-desethyl, Atrazine-desisopropyl, Cyanazine, Propazine, and Simazine, purchased from Sigma-Aldrich, St. Louis, MO, and Ultra Scientific, North Kingstown, RI. The following internal standards were used: Atrazine-d<sub>5</sub>, Atrazine-desethyl-d<sub>7</sub>, Atrazine-desisopropyl-d<sub>5</sub>, Cyanazine-d<sub>5</sub>, Propazine-d<sub>14</sub>, and Simazine-d<sub>10</sub>, purchased from C/D/N Isotopes, Inc., Pointe-Claire, Quebec, Canada. Standards and internal standard stocks were prepared in solutions of methanol and diluted to their appropriate concentrations prior to analysis.

## Sample Preparation

While no SPE was required for this method, samples were treated as per the EPA's draft method. The method calls for the addition of ammonium acetate at 20 mM for pH adjustment and dechlorination and sodium omadine at 64 mg/L to prevent microbial degradation, both purchased from Sigma-Aldrich, St. Louis, MO. All samples were prepared in reagent water. All samples were spiked with the internal standard solution, resulting in a final concentration of 5 ng/mL (ppb) for each internal standard. Calibration standards were prepared at the following levels: 0.25, 0.5, 1, 2, 2.5 and 5 ng/mL.

## HPLC Conditions

Column:	Thermo Scientific Hypersil GOLD™ 100 x 2.1 mm, 3 μm		
Solvent A:	5 mM Ammonium Acetate		
Solvent B:	Methanol		
Flow Rate:	400 μL/min		
Injection Volume:	100 μL		
HPLC Gradient:	Time	%A	%B
	0:00	98	2
	10:00	98	2
	20:00	10	90
	25:00	10	90
	25:06	98	2
	30:00	98	2

## Mass Spectrometer Conditions

Ionization Source:	Positive Electrospray
Sheath Gas:	30 arbitrary units
Auxiliary Gas:	10 arbitrary units
ESI Voltage:	3.5 kV
Ion Transfer Tube Temperature:	350 °C
Collision Gas:	1.5 mTorr
Q1/Q3 Peak Resolution:	0.7 Da
Scan Width:	0.01 Da

## MS Parameters

Compound	Precursor Mass	Product Mass	Collision Energy	Tube Lens
Atrazine-desisopropyl	174	132	17	90
Atrazine-desethyl	188	146	16	95
Simazine	202	124	17	80
Atrazine	216	174	16	85
Propazine	230	124	17	80
Cyanazine	241	214	15	100
Atrazine-desisopropyl-d <sub>5</sub>	179	137	17	85
Atrazine-desethyl-d <sub>7</sub>	195	147	17	95
Simazine-d <sub>10</sub>	212	137	19	95
Atrazine-d <sub>5</sub>	221	179	17	95
Propazine-d <sub>14</sub>	244	196	18	95
Cyanazine-d <sub>5</sub>	246	219	16	100

## Results and Discussion

The triazine compounds eluted from the LC column in 20 minutes. A chromatogram of each compound and the internal standards is shown in Figure 1. All peaks are chromatographically resolved from one another. Calibration curves were generated for each compound over the range 0.25-5 ppb. All calibration curves exhibited excellent linearity, ranging from 0.9964 for Atrazine-desethyl to 0.9982 for Atrazine. The calibration curve for Simazine is shown in Figure 2. The other compounds exhibit similar linearity, and are not shown in this application note.

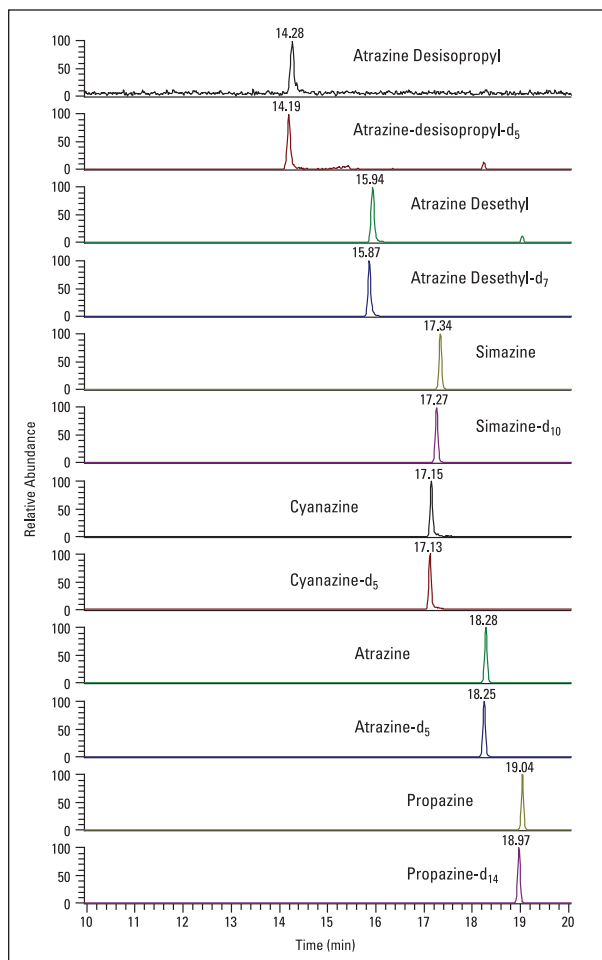

Figure 1: Chromatogram of the triazine compounds at 2 ppb, and their internal standards

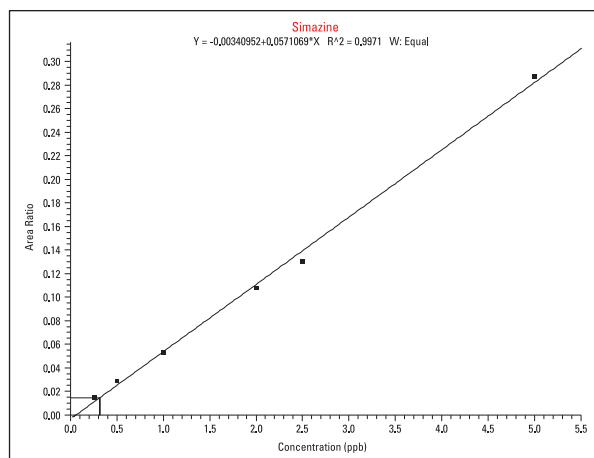

Figure 2: Calibration curve for Simazine, 0.25-5 ppb

## Conclusion

The TSQ Quantum Access LC-MS/MS is an excellent choice for the analysis of triazine compounds and their degradates. Linearity over the entire calibration range of 0.25 to 5 ppb is observed. Separation of all the analytes is achieved with the Hypersil GOLD column allowing for unambiguous identification and quantitation of all of the compounds in this application note.

## References

1. Smith, G.A., Pepich, B.V., Munch, D.J. "Determination of Triazine Pesticides and their Degradates in Drinking Water by Liquid Chromatography Electrospray Ionization Mass Spectrometry (LC/ESI/MS)" Draft 5.0, April 2007.

## Legal Notices

©2016 Thermo Fisher Scientific Inc. All rights reserved. All trademarks are the property of Thermo Fisher Scientific Inc. and its subsidiaries. This information is presented as an example of the capabilities of Thermo Fisher Scientific Inc. products. It is not intended to encourage use of these products in any manner that might infringe the intellectual property rights of others. Specifications, terms and pricing are subject to change. Not all products are available in all countries. Please consult your local sales representative for details.

View additional Thermo Scientific LC/MS application notes at: [www.thermo.com/appnotes](http://www.thermo.com/appnotes)

In addition to these offices, Thermo Fisher Scientific maintains a network of representative organizations throughout the world.

**Africa**  
+43 1 333 5034 127

**Australia**  
+61 2 8844 9500

**Austria**  
+43 1 333 50340

**Belgium**  
+32 2 482 30 30

**Canada**  
+1 800 530 8447

**China**  
+86 10 8419 3588

**Denmark**  
+45 70 23 62 60

**Europe-Other**  
+43 1 333 5034 127

**France**  
+33 1 60 92 48 00

**Germany**  
+49 6103 408 1014

**India**  
+91 22 6742 9434

**Italy**  
+39 02 950 591

**Japan**  
+81 45 453 9100

**Latin America**  
+1 608 276 5659

**Middle East**  
+43 1 333 5034 127

**Netherlands**  
+31 76 579 55 55

**South Africa**  
+27 11 570 1840

**Spain**  
+34 914 845 965

**Sweden/Norway/  
Finland**  
+46 8 556 468 00

**Switzerland**  
+41 61 48784 00

**UK**  
+44 1442 233555

**USA**  
+1 800 532 4752

[www.thermo.com](http://www.thermo.com)

AN62880\_E\_08/16M



# LC-MS/MS Analysis of Herbicides in Drinking Water at Femtogram Levels Using 20 mL EQuan Direct Injection Techniques

Jonathan R. Beck, Charles Yang, Thermo Fisher Scientific, San Jose, CA, USA

## Introduction

As concerns grow over the toxic effects of herbicides and other chemicals in our environment, the need to accurately monitor these substances in drinking water and foods becomes even more critical. LC-MS/MS is routinely used by the environmental and food industries to identify and quantify pesticide and herbicide residues. However, this method typically requires extensive offline sample preconcentration methods, which can be expensive and time-consuming, to meet the stringent requirements and low limits of detection set forth by federal and international regulatory authorities. An online preconcentration and cleanup method has been developed that improves both sensitivity and precision and yields unmatched throughput.

The Thermo Scientific EQuan™ system for online sample cleanup and analysis consists of a triple quadrupole mass spectrometer with an electrospray ionization source (ESI), two LC quaternary pumps, an autosampler, and two LC columns having C18 selectivity—one for preconcentration of the sample, the second for analytical separation. A 6-port valve switches between the columns and is controlled by the instrument software. In addition to quantitative information, qualitative full scan product ion spectra are collected in the same analytical run and data file, using a technique called Reverse Energy Ramp (RER). This full scan spectrum provides additional confirmatory information for the compounds being analyzed. The resulting product ion spectra can be library searched for positive identification, or ion ratios can be used to confirm the presence of a particular compound, helping to eliminate “false positive” samples. This method uses drinking water for direct injection onto the loading column, with no sample preparation or offline concentration. This application note provides a comparison of the online sample preconcentration of 1 mL, 5 mL, and 20 mL injections of drinking water samples spiked with herbicide compounds.

## Goal

To compare different large volume injections using a loading column and an analytical column with two HPLC pumps.

## Experimental Conditions

### Sample Preparation

Drinking water containing 0.1% formic acid was spiked with a mixture of the following herbicides: ametryn, atraton, atrazine, prometon, prometryn, propazine, secbumeton, simetryn, simazine, terbuthylazine, and terbutryn (Ultra Scientific, North Kingstown, RI). The concentrations of the herbicides in the spiked water ranged from 0.1 pg/mL to 10 pg/mL. Calibration standards were prepared at the following concentrations: 0.1, 0.5, 1.0, 5.0, and 10.0 pg/mL.

### HPLC

Spiked water samples and blank water samples (1 mL, 5 mL, or 20 mL) were injected directly onto a loading column (Thermo Scientific Hypersil GOLD™ 20 mm x 2.1 mm ID, 12 μm) using an HTC PAL autosampler (CTC Analytics, Zwingen, Switzerland). After the sample was completely transferred from the sample loop to the loading column, a 6-port valve was switched to enable the loading column to be back flushed onto the analytical column (Hypersil GOLD 50 mm x 2.1 mm ID, 3 μm), where the compounds were separated prior to introduction into the mass spectrometer. After all of the compounds were eluted, the valve was switched back to the starting position. The loading and analytical columns were cleaned with a high organic phase before being re-equilibrated to their starting conditions (Figure 1a and 1b). Control and timing of the 6-port valve was through the computer data system, LCQUAN™ (Thermo Fisher Scientific, San Jose, CA).

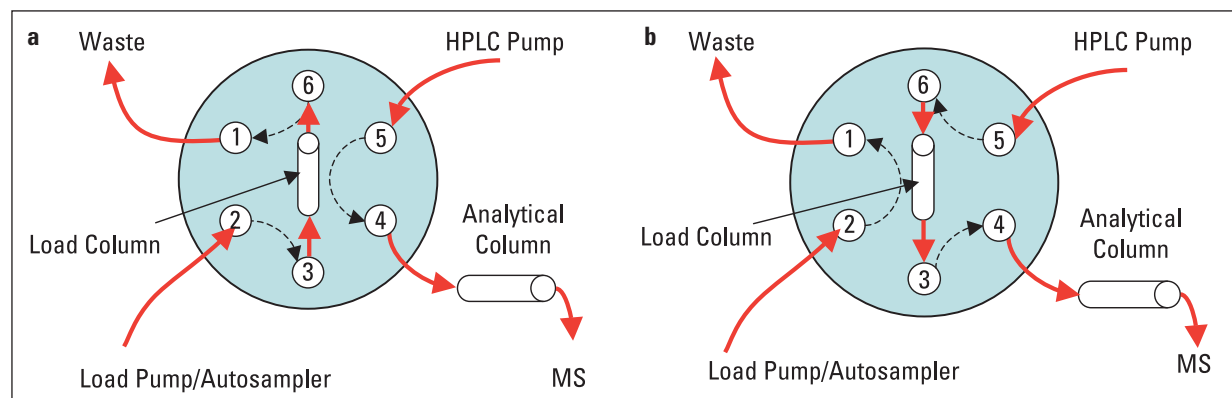

Figure 1: a) 6-port valve in position 1 (load position), for loading the sample onto the loading column. b) 6-port valve in position 2 (inject position), for eluting the compounds trapped on the loading column onto the analytical column.

## Key Words

- TSQ Quantum Access
- EQuan System
- Herbicides
- QED
- Water Analysis

Slightly different LC programs were used in each method, depending on the volume of the sample injected. The loading pump flow rates ranged from 1 mL/min for 1 mL samples to 5 mL/min for 20 mL samples. This allowed the run times at the higher injection volumes to be shortened because the time to transfer the sample from the sample loop to the loading column depends on the flow rate. The same LC program was used for the analytical column.

Two HPLC pumps were used for the analysis: one for transferring the sample from the injection loop to the loading column, and one for back flushing the compounds off of the loading column and separating them on the analytical column. The loading pump was a Surveyor Plus™ LC pump (Thermo Fisher Scientific, San Jose, CA) and the analytical pump was a U-HPLC Accela™ pump (Thermo Fisher Scientific, San Jose, CA).

The HTC autosampler was equipped with a 5 mL syringe. To accommodate larger injection volumes (> 5 mL), a CTC™ macro sequence was programmed to allow for multiple syringe fills and deliveries to the sample loop from a 10 mL vial. For 20 mL samples, two 10 mL vials were used and the macro allowed sampling from adjacent vials filled with the same sample. The macro is shown in Figure 2. Because this multi-sampling scheme can be quite time consuming, the ability to perform “look-ahead” injections allows for significant time savings. The loop can be switched to an offline position during a run, and subsequent samples can be prepared and injected while a sample is being run.

## MS

MS analysis was carried out on a TSQ Quantum Access™ triple stage quadrupole mass spectrometer with an electrospray ionization (ESI) source (Thermo Scientific, San Jose, CA). The MS conditions were as follows:

Ion Source Polarity:	Positive ion mode
Spray Voltage:	4000 V
Ion Transfer Tube Temperature:	300 °C
Sheath Gas Pressure:	30 arbitrary units
Auxiliary Gas Pressure:	5 arbitrary units
Collision Gas (Ar):	1.5 mTorr
Q1/Q3 Peak Resolution:	0.7 Da
Scan Width:	0.002 Da

Quantitative and qualitative data were collected in the same run and data file.

## Results and Discussion

Chromatograms of the herbicide simazine at three different injection volumes are shown in Figure 3. A very small peak can be seen for the 1 mL injection volume; however, the integration is not shown in the chromatogram. Injections at higher volumes show superior signal-to-noise ratios and intensity, which allow for analysis of very low concentration samples (pg/mL and sub pg/mL). To test the reproducibility of the multiple syringe fill method with a 20 mL loop, eight replicate injections were performed using the 1 pg/mL calibration standard. The results of this study are shown in Table 1. No internal standard was used in this analysis; however, if one were to be included, the % Relative Standard Deviations (RSD) values would likely improve. Table 1 also shows the peak areas and calculated difference in peak areas between the 1, 5, and 20 mL injections.

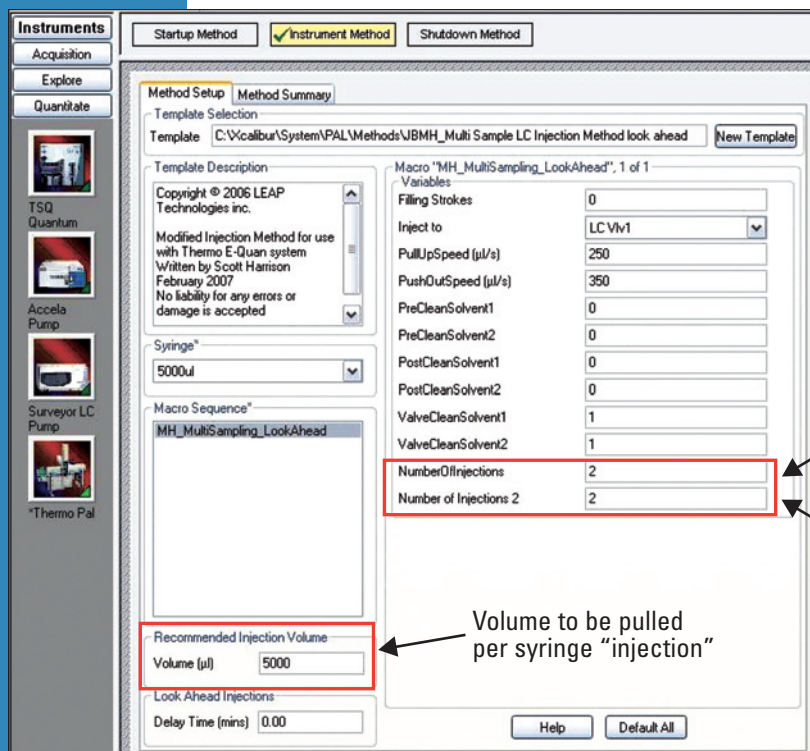

Number of syringe fills from the first vial.

Number of syringe fills from the second vial (optional).

Volume to be pulled per syringe “injection”

Figure 2: The method setup screen for the CTC Autosampler, showing the capability to perform multiple injections from the same vial. The red box highlights the parameters used to control the number of syringe fills from two consecutive vials. In this example, a total of 20 mL will be injected.



Compound	Area, 1 mL	Area, 5 mL	Area, 20 mL	Factor 1 mL to 5 mL	Factor 5 mL to 20 mL	%RSD (n = 8)
Atraton	ND	1.16E+07	5.42E+07	N/A	4.69	11.15
Simetryn	ND	4.27E+06	1.94E+07	N/A	4.56	8.93
Prometon/Secbumeton	3.26E+06	1.07E+07	4.80E+07	3.30	4.47	9.89
Ametryn	4.34E+06	1.42E+07	5.99E+07	3.27	4.22	11.59
Simazine	3.18E+05	1.28E+06	5.70E+06	4.03	4.44	5.32
Prometryn/Terbutryn	6.19E+06	1.89E+07	7.61E+07	3.05	4.02	3.99
Atrazine	1.26E+06	4.45E+06	1.55E+07	3.53	3.49	4.97

Table 1: Reproducibility for 20 mL injections (n = 8) at a 1 pg/mL concentration level, without an internal standard.

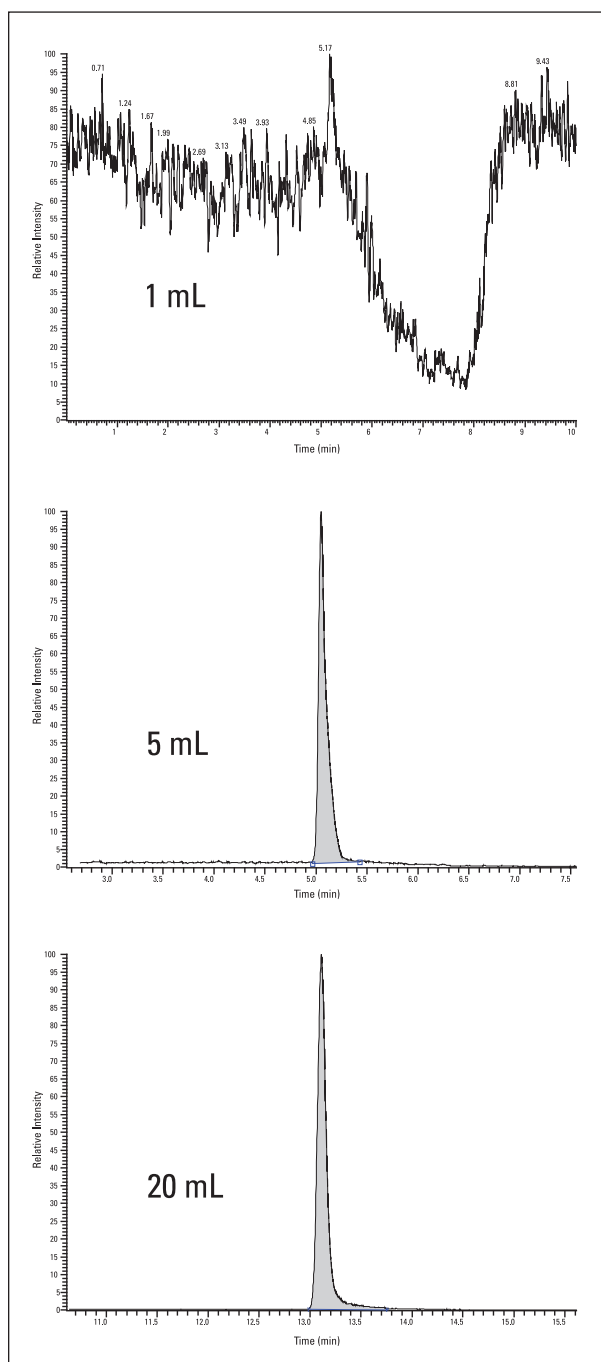

Figure 3: Chromatograms showing the injection of simazine with 1, 5, and 20 mL injection volumes. The concentration of simazine is 1 pg/mL for all three injections.

In addition to quantitative data, qualitative data was collected for each analyte using Quantitation-Enhanced Data-Dependent MS/MS (QED-MS/MS) scanning with the Reverse Energy Ramp (RER) scan function. The reverse energy ramp allows the collision energy in Q2 to be ramped from a high energy to a lower energy as Q3 is scanning the product ions from Q2 from low mass to high mass. This provides a rich product ion spectrum that can be used for library searching or ion ratio calculations to help eliminate “false positive” results. The RER provides a much “richer” product ion when compared to a Q3 product ion scan collected with a static collision energy. For this experiment, the collision energy for the RER was set to 25 eV and the ramp value was set to 20 eV. This results in a ramp from 45 eV at the low mass range of Q3. As Q3 scans to higher masses, the collision energy in Q2 is ramped lower and ends at a collision energy of 25 eV. Figure 4 shows the full scan Q3 spectrum that was collected during the analytical run for the calibration standard at a level of 1 pg/mL. It also shows a ramp illustrating the collision energy ramp applied to Q2.

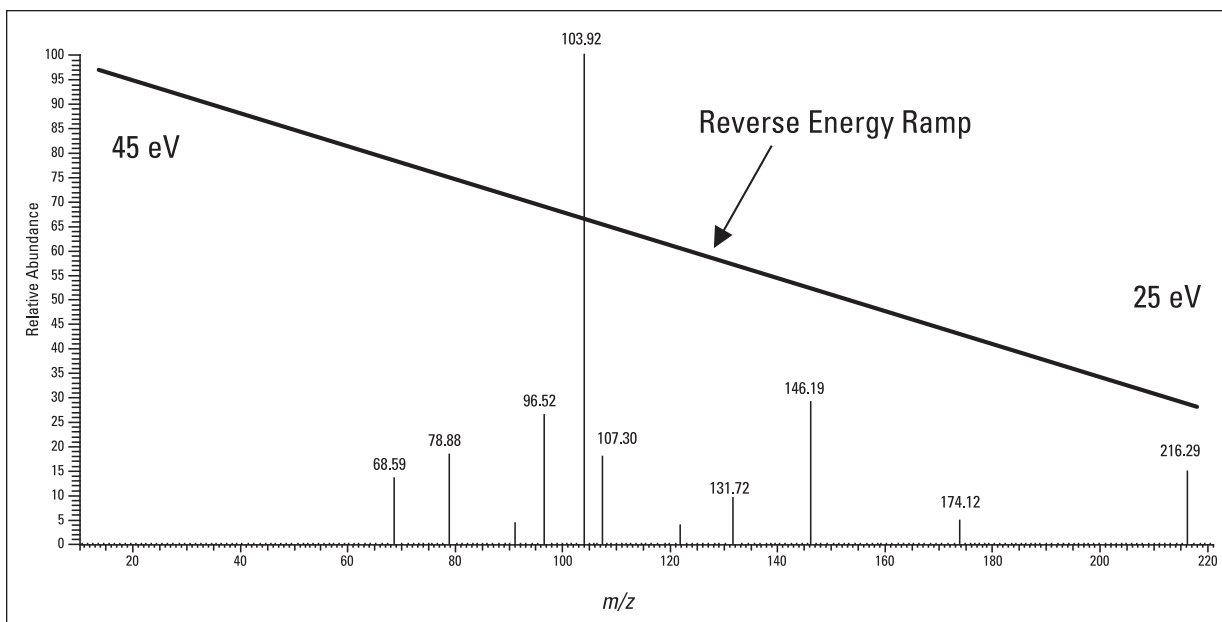

Figure 4. QED-MS/MS Q3 spectrum for a 1pg/mL injection of atrazine. The collision energy was 25 eV and the ramp was 20 eV.

## Conclusion

Using a preconcentration column in tandem with an analytical HPLC column allowed for the quantitation of a triazine herbicide mixture over the concentration range 0.1 – 10.0 pg/mL. Direct 20 mL injections were performed with the two HPLC columns. The large injection volume capabilities of the EQuan system eliminated the need for laborious and expensive offline preconcentration using solid phase extraction. Injection volumes ranging from 1 mL to 20 mL are possible using this configuration, thus offering flexibility for laboratories based on their sensitivity and reporting requirements.

## Acknowledgements

We would like to thank Scott Harrison from LEAP Technologies (Carrboro, NC) for assistance with the CTC macro for multiple syringe fills and Mark Harrison from Thermo Fisher Scientific (Hemel-Hempsted, UK) for further assistance with the macro and for technical discussions.

## Legal Notices

©2016 Thermo Fisher Scientific Inc. All rights reserved. CTC is a trademark of CTC Analytics AG. All other trademarks are the property of Thermo Fisher Scientific Inc. and its subsidiaries. This information is presented as an example of the capabilities of Thermo Fisher Scientific Inc. products. It is not intended to encourage use of these products in any manners that might infringe the intellectual property rights of others. Specifications, terms and pricing are subject to change. Not all products are available in all countries. Please consult your local sales representative for details.

View additional Thermo Scientific LC/MS application notes at: [www.thermo.com/appnotes](http://www.thermo.com/appnotes)

In addition to these offices, Thermo Fisher Scientific maintains a network of representative organizations throughout the world.

**Africa**  
+43 1 333 5034 127

**Australia**  
+61 2 8844 9500

**Austria**  
+43 1 333 50340

**Belgium**  
+32 2 482 30 30

**Canada**  
+1 800 530 8447

**China**  
+86 10 8419 3588

**Denmark**  
+45 70 23 62 60

**Europe-Other**  
+43 1 333 5034 127

**France**  
+33 1 60 92 48 00

**Germany**  
+49 6103 408 1014

**India**  
+91 22 6742 9434

**Italy**  
+39 02 950 591

**Japan**  
+81 45 453 9100

**Latin America**  
+1 608 276 5659

**Middle East**  
+43 1 333 5034 127

**Netherlands**  
+31 76 579 55 55

**South Africa**  
+27 11 570 1840

**Spain**  
+34 914 845 965

**Sweden/Norway/  
Finland**  
+46 8 556 468 00

**Switzerland**  
+41 61 48784 00

**UK**  
+44 1442 233555

**USA**  
+1 800 532 4752

[www.thermo.com](http://www.thermo.com)

AN62858\_E 08/16M

# Sensitive and Rapid Determination of Paraquat and Diquat in Tap and Environmental Waters

Chen Jing,<sup>1</sup> Xu Qun,<sup>1</sup> and Jeffrey Rohrer<sup>2</sup>

<sup>1</sup>Thermo Fisher Scientific, Shanghai, People's Republic of China; <sup>2</sup>Thermo Fisher Scientific, Sunnyvale, CA, USA

## Key Words

Acclaim Trinity P1 Guard Cartridge, Acclaim Trinity Q1 Analytical Column, Herbicides, On-Line SPE, U.S. EPA Method 549.2, Water Analysis

## Goals

To develop an efficient high-performance liquid chromatography (HPLC) method for the sensitive and rapid determination of paraquat and diquat in tap and environmental water samples:

- Using on-line solid phase extraction (SPE) and UV detection in the absence of an ion-pairing reagent in the mobile phase, and
- With method detection limits (MDLs) equal to or better than U.S. Environmental Protection Agency (EPA) Method 549.2 and European Union (EU) 98/83/EC

## Introduction

Paraquat and diquat (structures shown in Figure 1) are widely used as agriculture herbicides to control crop and aquatic weeds. Contamination of drinking and environmental waters with paraquat and diquat is considered a risk factor for liver, heart, lung, and kidney illnesses. The U.S. EPA specified a Maximum Contaminant Level Goal (MCLG) of 20 µg/L for diquat in drinking water,<sup>1</sup> and the EU published a general rule with a limit of 0.1 µg/L for pesticides and herbicides in drinking water (98/83/EC).<sup>2</sup>

Reversed-phase HPLC with UV detection is typically used for sensitive determination of paraquat and diquat, and ion-pairing reagents are added to the mobile phase to achieve baseline separation and symmetrical peaks on conventional reversed-phase columns (C18 or C8). This is the methodology used in EPA Method 549.2.<sup>3</sup> The use of other stationary phases, such as those in the



Thermo Scientific™ Acclaim™ Mixed-Mode HILIC-1<sup>4</sup> and Trinity™ P1<sup>5</sup> columns, has been reported to achieve baseline separation in the absence of an ion-pairing reagent; however, peak shapes were still less than ideal.

For the HPLC determination of diquat and paraquat in water samples, SPE is the typical method used for sample extraction and enrichment. Whereas EPA Method 549.2 describes off-line SPE for water sample preparation,<sup>3</sup> on-line SPE offers the advantages of full automation, the absence of operator influence, time savings, and strict process control. Although the authors previously reported an application of on-line SPE for the determination of diquat and paraquat in water samples by HPLC,<sup>5</sup> this more recent work shows an improved method using a new mixed-mode column specifically designed to provide good peak shapes for diquat and paraquat.

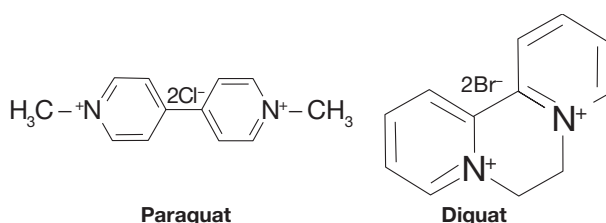

Figure 1. Structures of paraquat and diquat.

## Equipment

- Thermo Scientific™ Dionex™ UltiMate™ 3000 x2 Dual Rapid Separation LC (RSLC) system, including:
  - DGP-3600RS Dual Ternary RS Pump System with SRD-3600 Integrated Solvent and Degasser Rack
  - WPS-3000TRS RS Wellplate Sampler, Thermostatted, with a 1000 µL sample loop and a 1000 µL syringe
  - TCC-3000RS or TCC-3000SD RS Thermostatted Column Compartment equipped with one 2–6p valve
  - DAD-3000RS RS Diode Array Detector - Semi-Micro Flow Cell for DAD-3000 and MWD-3000 Series, SST, 2.5 µL Volume, 7 mm Path Length
- Thermo Scientific™ Dionex™ Chromeleon™ Chromatography Data System software, version 7.1
- Thermo Scientific™ Orion™ 2-Star Benchtop pH Meter
- Thermo Scientific™ Target2™ Nylon Syringe Filters, 0.45 µm, 30 mm (P/N F2500-1)

## Reagents and Standards

- Deionized (DI) water, 18.2 MΩ-cm resistivity
- Acetonitrile (CH<sub>3</sub>CN), HPLC Grade 99.9% (Fisher Scientific P/N AC610010040)
- Ammonium Acetate (CH<sub>3</sub>COONH<sub>3</sub>), Crystalline/ Certified ACS (Fisher Scientific P/N 631-61-8)
- Dimethyldichlorosilane (DMDCS), ≥99% (P/N 75-78-5)
- EPA-549.1 STDS 2COMP, 1 ML, Diquat and Paraquat Standard

## Working Standard Solutions for Calibration

Use the EPA-549.1 Diquat and Paraquat Standard and dilute with DI water to prepare a stock standard solution with 1.0 µg/mL of each compound. Prepare six working standard solutions for the calibration with different concentrations by adding the correct amount of stock standard solution and diluting with DI water. The volumes needed of each solution to make the calibration standards are shown in Table 1.

Table 1. Preparation of calibration curve standards.

Volume of Stock Standard Solution of Paraquat and Diquat, 1.0 µg/mL Each (mL)	Volume of DI Water (mL)	Final Volume (mL)	Final Concentration (µg/L)
0.01	9.99	10	1
0.05	9.95		5
0.50	9.50		50
1.00	9.00		100
5.00	5.00		500
10.0	0.00		1000

## Sample Preparation

Tap water samples were collected at the Thermo Fisher Scientific™ Shanghai Applications Lab. Pond water samples were collected at Zhangjiang High Science and Technology Park located in the Pudong District of Shanghai, China. Samples were filtered using Target2 nylon syringe filters prior to injection.

*Note: Soak all glassware used to prepare paraquat and diquat standard solutions for calibration or used in sample preparation for at least 8 h in a mixture of CH<sub>3</sub>CN and DMDCS (9:1, v/v) to avoid loss (adsorption) of diquat and paraquat.*

## Chromatographic Conditions

### On-Line SPE

Column:	Acclaim Trinity P1, 3 µm, Guard Cartridges, 3.0 × 10 mm (P/N 071390) with SST Guard Cartridge Holder V-2 (P/N 069580)
Mobile Phase:	A: 100 mM Ammonium Acetate (adjust pH 5.0 using acidic acid) B: Acetonitrile C: H <sub>2</sub> O
Gradient:	0–2 min, 10% A, 5% B 2.1–4.5 min, 55% A, 45% B 4.6–10 min, 10% A, 5% B
Flow Rate:	0.7 mL/min
Inj. Volume:	1000 µL onto the on-line SPE cartridge

### Separation

Column:	Acclaim Trinity Q1, 3 µm, Analytical, 3.0 × 50 mm (P/N 079716)
Mobile Phase:	35% 100 mM Ammonium Acetate (pH 5.0)/65% Acetonitrile
Flow Rate:	0.5 mL/min
Column Temp:	30 °C
Detection:	UV absorbance at 260 nm for paraquat and 310 nm for diquat

### Valve Position

0 min, 1\_2  
2.0 min, 6\_1  
4.5 min, 1\_2

## Results and Discussion

### Separation of Paraquat and Diquat on the Acclaim Trinity Q1 Column

The Acclaim Trinity Q1 column is based on innovative nanopolymer silica hybrid (NSH) technology and has reversed-phase, anion-exchange, and cation-exchange retention mechanisms that can be independently controlled.<sup>6</sup> The weak cation-exchange function provides retention and separation for diquat and paraquat, whereas the weak anion-exchange moiety effectively deactivates the undesirable interaction between the surface silanols and the analytes. As shown in Figure 2, this column provides sufficient retention, excellent resolution, good peak shape, and a fast analysis time for diquat and paraquat.

Column: Acclaim Trinity Q1, 3  $\mu$ m, Analytical (3.0  $\times$  50 mm)  
 Mobile Phase: 35% 100 mM Ammonium Acetate (pH 5.0)/65% Acetonitrile  
 Flow Rate: 0.5 mL/min  
 Temperature: 30  $^{\circ}$ C  
 UV Detection: Absorbance at 290 nm

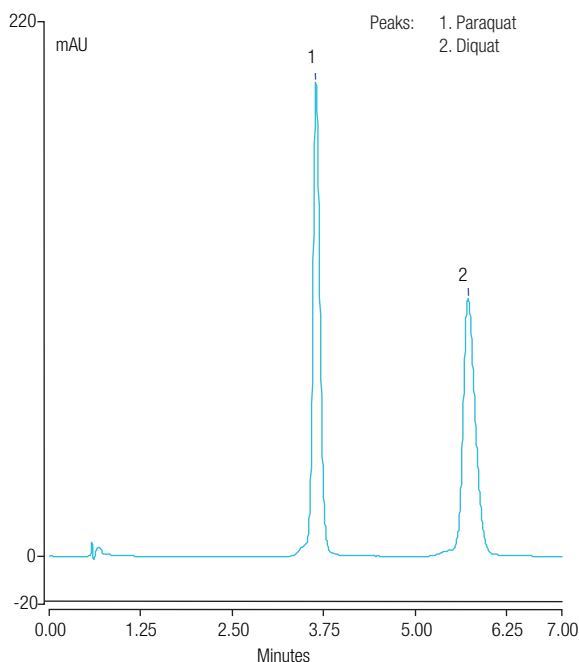

Figure 2. Chromatogram of paraquat and diquat (10 mg/L each).

The Acclaim Trinity Q1 column has weak cation-exchange functionality rather than the strong cation-exchange functionality of the Acclaim Trinity P1 column. Table 2 lists the performance measurements of the Acclaim Trinity P1<sup>5</sup> and Q1 columns for the separation of paraquat and diquat under chromatographic conditions optimized for each column. The results demonstrate the superiority of the Trinity Q1 column for this determination.

Table 2. Comparison of column performance for the separation of paraquat and diquat (5  $\mu$ g/mL) on the Acclaim Trinity P1 and Q1 columns.

Analyte	Acclaim Trinity P1 Column		Acclaim Trinity Q1 Column	
	Asymmetry	Peak Width (min)	Asymmetry	Peak Width (min)
Paraquat	1.68	0.22	0.98	0.17
Diquat	1.39	0.18	0.89	0.12

### Evaluations of On-Line SPE

Figure 3 shows a typical flow schematic of on-line SPE, which is directly coupled to the HPLC column using one 6-port (2 p to 6 p) valve. The filtered sample is injected directly onto the system and delivered to the SPE column for enrichment (1\_2 position) using the first pump; the analytical column is simultaneously equilibrated with the second pump of the dual-pump module. After the analytes are bound to the SPE column and impurities are washed out, the SPE column is switched into the analytical flow path to elute the bound analytes (6\_1 position); the analytes are then separated on the analytical column and detected by the UV detector. This method is easily accomplished using the UltiMate 3000 x2 Dual RSLC system.

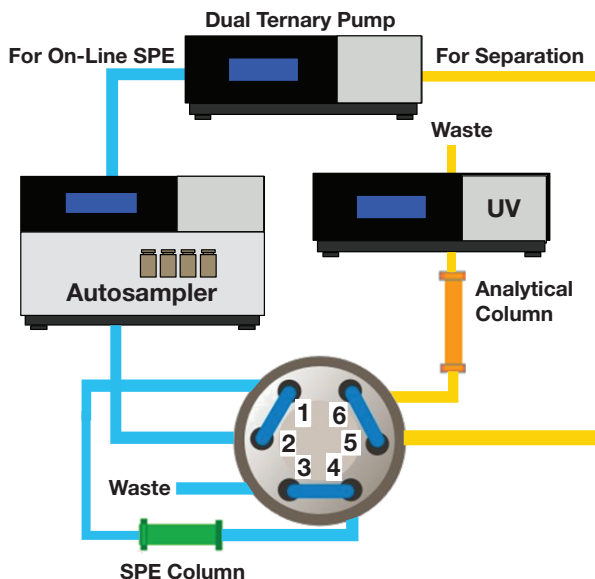

Figure 3. Flow schematic of on-line SPE.

### Optimization of On-Line SPE Conditions

To develop this on-line SPE method, an Acclaim Mixed-Mode WCX-1 Guard and an Acclaim Trinity P1 Guard—both of which have been reported as on-line SPE cartridges for the determination of paraquat and diquat in drinking and environmental waters—were evaluated following the typical on-line SPE flow schematic shown in Figure 3.<sup>5</sup> Although either of these products can be used as an SPE cartridge for the enrichment of paraquat and diquat, the Acclaim Trinity P1 Guard cartridge was selected due to the easier elution of paraquat and diquat using an acetonitrile and 100 mM ammonium acetate (pH 5.0) mobile phase—the same as that used for the separation on the Acclaim Trinity Q1 Analytical column.

### Optimization of Separation Conditions

The Acclaim Trinity Q1 column is designed for applications using volatile buffers such as ammonium acetate, which are compatible with MS, charged aerosol, and UV (>225 nm) detections.<sup>6</sup> The separation can be optimized by adjusting the mobile phase buffer concentration, buffer pH value, and organic solvent content.

The ammonium acetate buffer was effective for this application, and its concentration affected retention of both diquat and paraquat. Higher buffer concentration shortened retention times, and 100 mM was selected for the rapid analysis. Buffer pH value has significant effect on the resolution of diquat and paraquat. It has been reported that pH  $5 \pm 0.5$  is a suitable pH range for this application;<sup>6</sup> therefore, pH 5.0 was used. Mobile phase organic solvent content affects retention and resolution of both diquat and paraquat. Experiments showed that with 100 mM ammonium acetate, mobile phases containing 55–75% acetonitrile gave excellent resolution and sufficient retention times. Therefore, 65% acetonitrile was used in this application.

Figure 4 illustrates rapid baseline separation of paraquat and diquat following on-line SPE under the specified chromatographic conditions. The entire chromatographic analysis is completed within 7 min.

#### For On-Line SPE

Column: Acclaim Trinity P1, 3  $\mu$ m, Guard Cartridges (3.0  $\times$  10 mm) with V-2 Holder  
 Mobile Phase: A: 100 mM Ammonium Acetate (pH 5.0)  
 B: Acetonitrile  
 C: H<sub>2</sub>O  
 Gradient: 0–2 min, 10% A, 5% B  
 2.1–4.5 min, 55% A, 45% B  
 4.6–10 min, 10% A, 5% B  
 Flow Rate: 0.7 mL/min  
 Inj. Volume: 1000  $\mu$ L onto the on-line SPE cartridge

#### For Separation

Column: Acclaim Trinity Q1, 3  $\mu$ m, Analytical (3.0  $\times$  50 mm)  
 Mobile Phase: 35% 100 mM Ammonium Acetate (pH 5.0)/65% Acetonitrile  
 Flow Rate: 0.5 mL/min  
 Temperature: 30 °C  
 Detection: UV absorbance at 260 nm for paraquat and 310 nm for diquat  
 Valve Position: 0 min, 1\_2  
 2.0 min, 6\_1  
 4.5 min, 1\_2

Samples: (a) Absorbance at 260 nm  
 (b) Absorbance at 310 nm

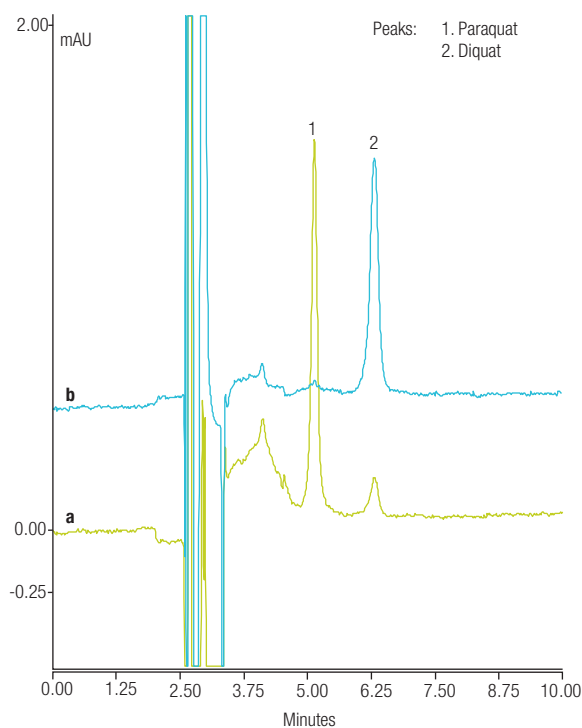

Figure 4. Chromatograms of a paraquat and diquat standard (1.0  $\mu$ g/L each) following on-line SPE.

### Reproducibility, Linearity, and Detection Limits

Method precision using UV detection was estimated by making five consecutive 1000 µL injections of a calibration standard, each with a concentration of 100 µg/L. The reproducibilities of retention time and peak area relative standard deviation (RSD) are summarized in Table 3.

Table 3. Reproducibility of peak retention time and area.

Analyte	Retention Time RSD	Peak Area RSD
Paraquat	0.18	4.85
Diquat	0.15	4.69

Calibration linearity for UV detection of paraquat and diquat was investigated by making three consecutive 1000 µL injections of a mixed standard prepared at six different concentrations (i.e., 18 total injections). The external standard method was used to establish the calibration curve and to quantify paraquat and diquat in the drinking and environmental water samples. Excellent linearity was observed from 1 to 1000 µg/L when plotting the concentration versus peak area, and the coefficients of determination were all  $\geq 0.99097$  (Table 4).

Table 4. Method linearity data and MDLs.

Analyte	Regression Equation	$r^2$	Range of Standards (µg/L)	MDL* (µg/L)
Paraquat	$A = 0.1968 c - 1.0993$	0.99996	1–1000	0.09
Diquat	$A = 0.1557 c - 2.0420$	0.99709		0.10

\* The single-sided Student's *t* test method (at the 99% confidence limit) was used for determining MDL, where the standard deviation of the peak area of five injections was multiplied by 4.6 to yield the MDL.

Table 5. Analysis results of spiked water samples.

Sample	Tap Water				Pond Water			
	Analyte	Detected (µg/L)	Added (µg/L)	Found (µg/L)	Recovery (%)	Detected (µg/L)	Added (µg/L)	Found (µg/L)
Paraquat	Not Detected	100	105	105	Not Detected	100	104	104
Diquat								

The MDLs of all compounds subjected to UV detection were calculated using the equation:

$$\text{Detection Limit} = S t_{(n-1, 1-\alpha=0.99)}$$

The symbol *S* represents standard deviation of replicate analyses, *n* represents number of replicates,  $t_{(n-1, 1-\alpha=0.99)}$  represents Student's *t* value for the 99% confidence level with *n* – 1 degrees of freedom. Five replicate injections of reagent water spiked with 100 µg/L of paraquat and diquat standard mixture were used to determine the MDLs. Table 4 summarizes the MDL data, which show excellent method sensitivity with detection limits equivalent to those defined in EPA Method 549.2 and which meet the restriction in 98/83/EC.

### Tap Water and Environmental Water Analysis

Figures 5 and 6 show chromatograms of a tap water sample and a pond water sample. No target analytes were found. The analysis results and related data are summarized in Table 5, demonstrating that this on-line SPE HPLC method provides good selectivity and suitability for the determination of paraquat and diquat in water samples.



**For On-Line SPE**

Column: Acclaim Trinity P1, 3  $\mu$ m, Guard Cartridges (3.0  $\times$  10 mm) with V-2 Holder  
 Mobile Phase: A: 100 mM Ammonium Acetate (pH 5.0)  
 B: Acetonitrile  
 C: H<sub>2</sub>O  
 Gradient: 0–2 min, 10% A, 5% B  
 2.1–4.5 min, 55% A, 45% B  
 4.6–10 min, 10% A, 5% B  
 Flow Rate: 0.7 mL/min  
 Inj. Volume: 1000  $\mu$ L onto the on-line SPE cartridge

**For Separation**

Column: Acclaim Trinity Q1, 3  $\mu$ m, Analytical (3.0  $\times$  50 mm)  
 Mobile Phase: 35% 100 mM Ammonium Acetate (pH 5.0)/65% Acetonitrile  
 Flow Rate: 0.5 mL/min  
 Temperature: 30  $^{\circ}$ C  
 Detection: UV absorbance at (A) 260 nm for paraquat and  
 (B) 310 nm for diquat  
 Valve Position: 0 min, 1\_2  
 2.0 min, 6\_1  
 4.5 min, 1\_2

Samples: (a) Tap water sample  
 (b) The same sample spiked with a paraquat and diquat standard (100  $\mu$ g/L each)

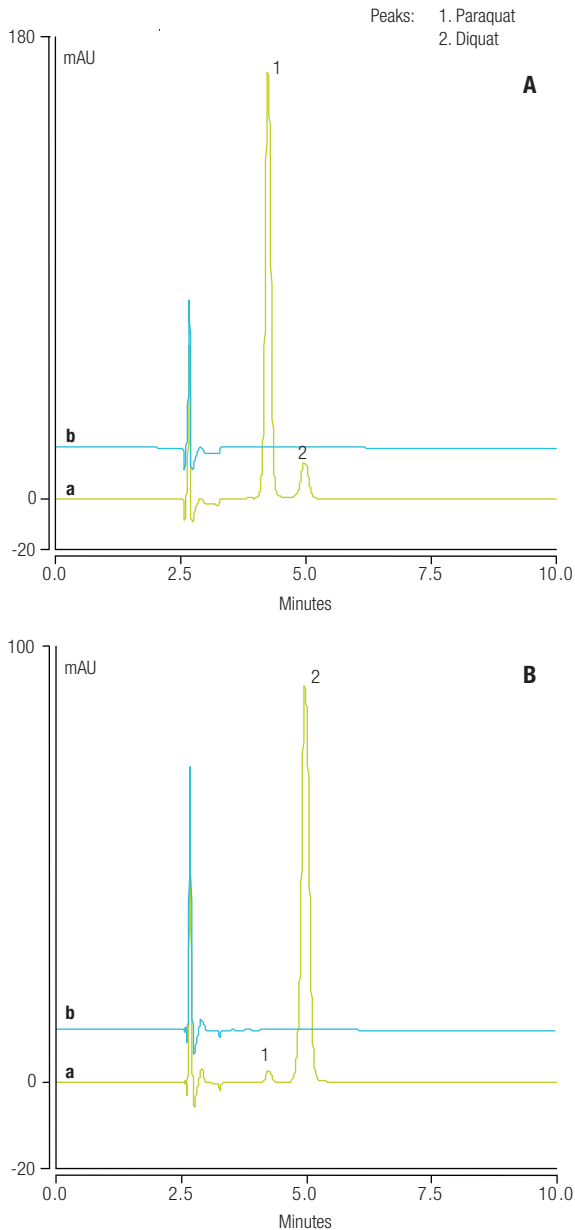

Figure 5. Chromatograms of a tap water sample and the same sample spiked with a paraquat and diquat standard at (A) 260 nm and (B) 310.

**For On-Line SPE**

Column: Acclaim Trinity P1, 3  $\mu$ m, Guard Cartridges (3.0  $\times$  10 mm) with V-2 Holder  
 Mobile Phase: A: 100 mM Ammonium Acetate (pH 5.0)  
 B: Acetonitrile  
 C: H<sub>2</sub>O  
 Gradient: 0–2 min, 10% A, 5% B  
 2.1–4.5 min, 55% A, 45% B  
 4.6–10 min, 10% A, 5% B  
 Flow Rate: 0.7 mL/min  
 Inj. Volume: 1000  $\mu$ L onto the on-line SPE cartridge

**For Separation**

Column: Acclaim Trinity Q1, 3  $\mu$ m, Analytical (3.0  $\times$  50 mm)  
 Mobile Phase: 35% 100 mM Ammonium Acetate (pH 5.0)/65% Acetonitrile  
 Flow Rate: 0.5 mL/min  
 Temperature: 30  $^{\circ}$ C  
 Detection: UV absorbance at (A) 260 nm for paraquat and  
 (B) 310 nm for diquat  
 Valve Position: 0 min, 1\_2  
 2.0 min, 6\_1  
 4.5 min, 1\_2

Samples: (a) A pond water sample  
 (b) The same sample spiked with a paraquat and diquat standard (100  $\mu$ g/L each)

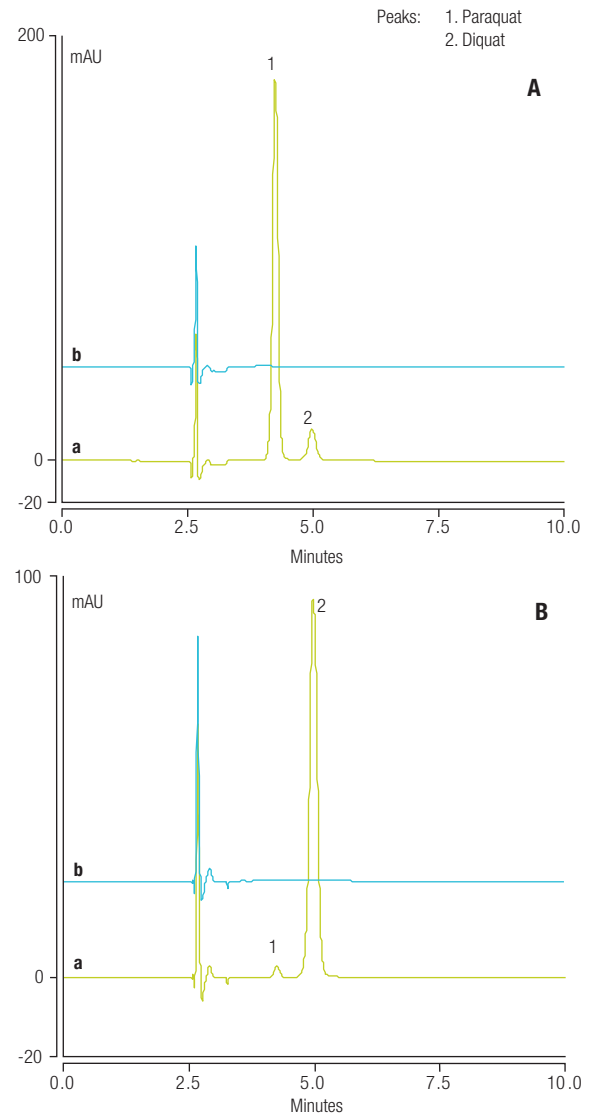

Figure 6. Chromatograms of a pond water sample and the same sample spiked with a paraquat and diquat standard at (A) 260 nm and (B) 310 nm.

## Conclusion

This work describes a method that uses on-line SPE HPLC with UV absorbance for determining paraquat and diquat in drinking and environmental waters in <10 min per sample. The determination is performed on an UltiMate 3000 x2 Dual RSLC system controlled by Chromeleon software. The reduced MDLs achieved using UV detection and on-line SPE provide a convenient method for determining these compounds in drinking and environmental waters. This approach also meets the MDL requirements specified in both U.S. EPA Method 549.2 and EU 98/83/EC.

## References

1. *Basic Information about Regulated Drinking Water Contaminants*; U.S. Environmental Protection Agency, Environmental Monitoring and Support Laboratory: Cincinnati, OH, 1997. [Online] <http://water.epa.gov/drink/contaminants/basicinformation/diquat.cfm>. (accessed Jan 28, 2013).
2. Directive 98/83/EC. *Official Journal of the European Council, Quality of Water Intended for Human Consumption*; L 330/42; 1998.
3. *Method 549.2: Determination of Diquat and Paraquat in Drinking Water by Liquid-Solid Extraction and High-Performance Liquid Chromatography with Ultraviolet Detection*; Revision 1.0; U.S. Environmental Protection Agency, Environmental Monitoring and Support Laboratory: Cincinnati, OH, 1997.
4. Thermo Scientific Application Brief 114: Improved Separation of Diquat and Paraquat Using the Acclaim Mixed-Mode HILIC-1 Column. Sunnyvale, CA, 2012. [Online] [www.dionex.com/en-us/webdocs/87647-AB114-LC-Diquat-Paraquat-Acclaim-HILIC-1-05Oct2012-AB70230\\_E.pdf](http://www.dionex.com/en-us/webdocs/87647-AB114-LC-Diquat-Paraquat-Acclaim-HILIC-1-05Oct2012-AB70230_E.pdf) (accessed Jan 30, 2013).
5. Dionex (now part of Thermo Scientific) Application Note 274: Sensitive On-Line SPE-HPLC Determination of Paraquat and Diquat in Drinking and Environmental Waters. Sunnyvale, CA, 2011. [Online] [www.dionex.com/en-us/webdocs/110577-AN274-HPLC-Paraquat-Diquat-Water-05Apr2011-LPN2726.pdf](http://www.dionex.com/en-us/webdocs/110577-AN274-HPLC-Paraquat-Diquat-Water-05Apr2011-LPN2726.pdf) (accessed Jan 30, 2013).
6. *Product Specifications: Thermo Scientific Acclaim Trinity Q1 Columns for Trace Analysis of Diquat and Paraquat*; PS20567\_E 07/12S; Thermo Scientific: Sunnyvale, CA, 2012. [Online] [www.dionex.com/en-us/webdocs/113757-PS-Acclaim-Trinity-Q1-Jul2012-PS20567\\_E.pdf](http://www.dionex.com/en-us/webdocs/113757-PS-Acclaim-Trinity-Q1-Jul2012-PS20567_E.pdf) (accessed Jan 30, 2013).

[www.thermofisher.com/dionex](http://www.thermofisher.com/dionex)

©2016 Thermo Fisher Scientific Inc. All rights reserved. All trademarks are the property of Thermo Fisher Scientific Inc. and its subsidiaries. This information is presented as an example of the capabilities of Thermo Fisher Scientific Inc. products. It is not intended to encourage use of these products in any manners that might infringe the intellectual property rights of others. Specifications, terms and pricing are subject to change. Not all products are available in all countries. Please consult your local sales representative for details.

**Australia** +61 3 9757 4486  
**Austria** +43 1 333 50 34 0  
**Belgium** +32 53 73 42 41  
**Brazil** +55 11 3731 5140  
**China** +852 2428 3282

**Denmark** +45 70 23 62 60  
**France** +33 1 60 92 48 00  
**Germany** +49 6126 991 0  
**India** +91 22 6742 9494  
**Italy** +39 02 51 62 1267

**Japan** +81 6 6885 1213  
**Korea** +82 2 3420 8600  
**Netherlands** +31 76 579 55 55  
**Singapore** +65 6289 1190  
**Sweden** +46 8 473 3380

**Switzerland** +41 62 205 9966  
**Taiwan** +886 2 8751 6655  
**UK/Ireland** +44 1442 233555  
**USA and Canada** +847 295 7500

**Thermo**  
 S C I E N T I F I C

Part of Thermo Fisher Scientific



# Analysis of Diquat and Paraquat Using UHPLC Orbitrap MS – Method Development, Matrix Effects and Performance

*Jonathan Beck,<sup>1</sup> Paul Yang,<sup>2</sup> Xiaodong Liu,<sup>1</sup> Chunyan Hao,<sup>2</sup> Xiaoming Zhao,<sup>2</sup> Franca Morra,<sup>2</sup> Charles Yang,<sup>1</sup> Maciej Bromirski,<sup>1</sup> and Dipankar Ghosh<sup>1</sup>*

*<sup>1</sup>Thermo Fisher Scientific, San Jose, USA ; <sup>2</sup>Ontario Ministry of the Environment, Ontario, Canada*



## Overview

The purpose of this work was to investigate the effect of ultrahigh-performance liquid chromatography (UHPLC) mobile phases and operational parameters of a UHPLC-Orbitrap™ mass spectrometry system used in the analysis of quaternary ammonium herbicides paraquat (PQ) and diquat (DQ). UHPLC mobile phases of different pH values were evaluated to achieve optimum separation of PQ and DQ on a Thermo Scientific™ Acclaim™ Trinity™ Q1 column which was specifically designed for this application, as well as to observe the relative intensity changes of mass spectral peaks. The signal-to-noise ratio (SNR) of extracted ion chromatograms (XIC) obtained from different  $m/z$  at different pH values and declustering potential (corona voltage) of electrospray ionization (ESI) source were evaluated. Based on results obtained from this study, a method was developed for the unambiguous identification of PQ and DQ in environmental water samples with the ability to deliver analytical data with superior SNR, high precision and accuracy.

## Introduction

Paraquat (PQ, 1,1'-dimethyl-4,4'-bipyridylium dichloride,  $C_{12}H_{14}N_2Cl_2$ ) and diquat (DQ, 1,1'-ethylene-2,2'-bipyridilium dibromide,  $C_{12}H_{12}N_2Br_2$ ) are quaternary amines widely used as non-selective and non-systematic herbicides for both terrestrial and aquatic plant control. Both PQ and DQ are toxic by contact and/or ingestion. The Ontario Drinking Water Quality Standards (Ontario Regulation 169/03) has a standard of 70 and 10  $\mu\text{g/L}$ , respectively for diquat and paraquat. Diquat is also regulated by the United States (U.S.) Environmental Protection Agency (EPA) at a maximum contaminant limit (MCL) of 20  $\mu\text{g/L}$  in drinking water, while PQ is unregulated by the U.S. EPA. The European Union has a drinking water MCL of 0.1  $\mu\text{g/L}$  for any individual pesticide and a combined 0.5  $\mu\text{g/L}$  MCL for all pesticides. Different data quality objectives (DQO) derived from these regulations dictate the need for a reliable/versatile method with a superior analytical sensitivity (i.e. <0.1  $\mu\text{g/L}$  or better) to meet different regulatory requirements.

Methods commonly used for PQ and DQ analysis include the separation by ion-pairing liquid chromatography, capillary electrophoresis, hydrophilic interaction liquid chromatography or ion-exchange chromatography using either ultraviolet (UV) or mass spectrometry for detection. Depending on the technology, method detection limits (MDL) have been established in the low  $\mu\text{g/L}$  for PQ and high ng/L for DQ. A 2012 U.S. Geological Survey report showed that about 3 million and 150,000 pounds of PQ and DQ were used annually in the United States (Ref 1).

Liquid chromatography-tandem mass spectrometry (LC-MS/MS) using an ESI interface has been the method of choice for PQ and DQ analysis since late 1990s. Depending on the pH of LC mobile phase and ESI source used, the deprotonated cation  $[M - H]^+$  ( $m/z$  183 for DQ and  $m/z$  185 for PQ), the singly charged radical ion  $[M]^{\cdot+}$  ( $m/z$  184 for DQ and  $m/z$  186 for PQ) and, to a less extent, the doubly charged quasi molecular ion  $M^{2+}$  ( $m/z$  92 for DQ and  $m/z$  93 for PQ) have been observed in the ESI mass spectra. The multiple reaction monitoring (MRM) transitions used in the analysis varied depending on the instrument and mobile phase. Commonly used precursor ions are the singly charged radical ion  $[M]^{\cdot+}$  and deprotonated cation  $[M - H]^+$  with a limited mentioning on the use of the doubly charged quasi molecular ion  $M^{2+}$  (Ref 2). Many product ions have been used in the MRM transitions for PQ and DQ analysis. These can be, for example, from the loss of masses 15 ( $[M - CH_3]^+$ ,  $m/z$  170) or 27 ( $[(M - H) - HCN]^+$ ,  $m/z$  158) for PQ; while those at  $m/z$  168 ( $[(M - H) - CH_3]^+$ ) and  $m/z$  157 ( $[(M - H) - C_2H_2]^+$ ) for DQ analysis (Ref. 3). Product ions resulted from the loss of masses 16 ( $[(M - H) - CH_3 - H]^+$ ,  $m/z$  169) or 42 ( $[(M - H) - CH_3 - HCN]^+$ ,  $m/z$  143) for PQ; and at  $m/z$  130 ( $[(M - H) - C_2H_2 - HCN]^+$ ) for DQ analysis (Ref. 4). A literature review showed more than 10 different MRM transitions may be used in the analysis of these two pesticides.

With the three available precursor ions from PQ ( $m/z$  93, 185 and 186) and DQ ( $m/z$  92, 183, 184), products ions of PQ and DQ may be differentiated by 1 amu. As the DQ  $^{13}\text{C}$ -isotopic mass at  $m/z$  185 would overlap with the  $[M - H]^+$  of PQ, one might expect interference in the analysis of PQ and DQ with inferior LC separation and MS data collected with unit mass resolution. Diquat has been known to have high ionization efficiency, with about 13% intensity of the native mass spectral peak of DQ contributing to PQ through the  $^{13}\text{C}$ -isotopic peak, quantitative results obtained for PQ might be biased high. We report in this poster the relationship between pH of mobile phase and the population of the three possible molecular formations of PQ DQ, the root cause of analytical interference and a direct injection UHPLC-Orbitrap MS method for the analysis of PQ and DQ that meets the regulatory need of different jurisdictions.

# Methods

## Sample Preparation and Chemicals

Individual stock solutions of PQ and DQ were purchased from Ultra Scientific Analytical Solutions (Brockville, ON, Canada). Neat standards of deuterium (D) labelled PQ (D<sub>8</sub>-PQ) and DQ (D<sub>4</sub>-DQ) were purchased from CDN Isotope (Pointe-Claire, QC, Canada). Native and D-labelled intermediate standard solutions were prepared by mixing the corresponding DQ and PQ stock solutions. Five levels of analytical standard solutions were prepared by diluting intermediate solutions with nanopure water (pure water, generated by passing reverse osmosis water through a Thermo Scientific™ Barnstead™ Nanopure™ water purification system, Mississauga, ON, Canada). Due to the high ionic strength of PQ and DQ, plastic labware and/or silanized glassware were used to avoid their adsorption onto the glass surfaces.

ACS reagent grade ammonium acetate (CH<sub>3</sub>COONH<sub>4</sub>), acetic acid (CH<sub>3</sub>COOH) and hydrochloric acid (HCl) were purchased from Sigma-Aldrich (Oakville, ON, Canada). HPLC grade acetonitrile (CH<sub>3</sub>CN) was purchased from Fisher Scientific (Ottawa, ON, Canada). The current method employs direct injection that does not require sample preparation. Environmental samples were collected in a 500 mL polypropylene bottle and refrigerated at 5 ± 3 °C until analysis. Drinking water samples were analyzed as is while surface water samples were filtered through a 0.2 μ filter prior to analysis. A 1 mL aliquot of each sample was transferred to a 1.8-mL plastic autosampler vial, spiked with 10 μL of 500 μg/L, D-labelled internal standards to the concentration of 5 ng/mL, vortexed and stored under refrigeration until analysis.

## Ultra High Performance Liquid Chromatography

The Thermo Scientific™ Dionex™ UltiMate™ 3000 UHPLC used in the analysis consisted of a HRG-3400RS binary pump, WPS-3000 autosampler, and a TCC-3400 column compartment. Separation was achieved on a mixed-mode column Acclaim Trinity Q1 column (2.1 × 50 mm, 3 μm), using isocratic elution and mobile phase of acetonitrile:100 mM, pH5.0 ammonium acetate = 75:25 v/v, at a flow rate 0.45 mL/min. The column oven was set at 35°C. Both PQ and DQ were eluted within 5 minutes. Mobile phases used in the pH effect study were the same composition used in the analysis but prepared at pH of 3.5, 5, 6.2 and 7.3. Flow injection analysis was done by using 0.013 mm i.d. × 100 cm polyetherether ketone tubing at a flow rate of 0.4 mL/min and four different pH levels to determine the pH and declustering potential used in the UHPLC Orbitrap MS analysis.

## Mass Spectrometry

The UHPLC was interfaced to an Thermo Scientific™ Exactive™ Plus Orbitrap MS using a HESI II probe interface. The Orbitrap MS system was tuned and calibrated in positive mode by infusion of standard mixtures of MSCAL5. High purity nitrogen (>99%) was used in the ESI source (35 L/min) as well as in a higher energy collisional dissociation (HCD) cell, enabling collision induced dissociation (CID) experiment without precursor ion selection, i.e. “all-ion fragmentation” (AIF). The AIF experiment was done by using normalized collision energy (NCE) of 35 ± 14 eV. The UHPLC flow rate of 0.45 mL/min and column used resulted in chromatographic FWHM of 6-8 seconds. Mass spectrometric data were collected using a spray voltage (SV, the equivalent of declustering potential) of 1700 V, an Orbitrap MS resolving power of 140,000 (defined by the full-width-at-half-maximum peak width at *m/z* 200, R<sub>FWHM</sub>), resulting a scanning rate of > 1.5 scans/sec when using automatic gain control and a C-trap inject time of 50 msec. Therefore, at least nine data points were available to accurately define each XIC chromatogram from the UHPLC separation of PQ and DQ. The effect of SV on the formation of the three different quasi molecular ions of PQ and DQ was also studied by different SV from 700 to 3200 V.

## Data Analysis

Analytical data collected were processed offline using Thermo Scientific™ Xcalibur™, ExactFinder™ and TraceFinder™ data processing packages depending on the need. Xcalibur was used to process mass spectral data for graphic presentation. ExactFinder and TraceFinder softwares were used to derive quantitative data. Depending on the data, a mass extraction window (MEW) of 5 to 20 ppm (part-per-million) from both sides of the base peak were used to create XIC and quantitative analysis. Results were exported to Microsoft® Excel® for data compilation and statistical evaluation.

# Results

## Flow Injection Analysis

Figure 1 shows results from the flow injection analysis of PQ and DQ using mobile phases of three different pH values (i.e., 5, 6.2 and 7.3) at declustering potential (DP) from 3200 to 700 volts, in decreasing intervals of 500 volts. The purpose of this experiment was to determine an optimal DP such that maximal signal-to-noise ratio (SNR) of PQ and DQ measurement can be achieved in this study. Peak intensities were minimal for PQ and DQ at pH 3.5 and were not shown in the figure. It is evident that DP had very little effect on the sensitivity of PQ and DQ analysis. As a result, a DP of 2000 volts is used throughout this work.

FIGURE 1. Results of flow injection analysis.

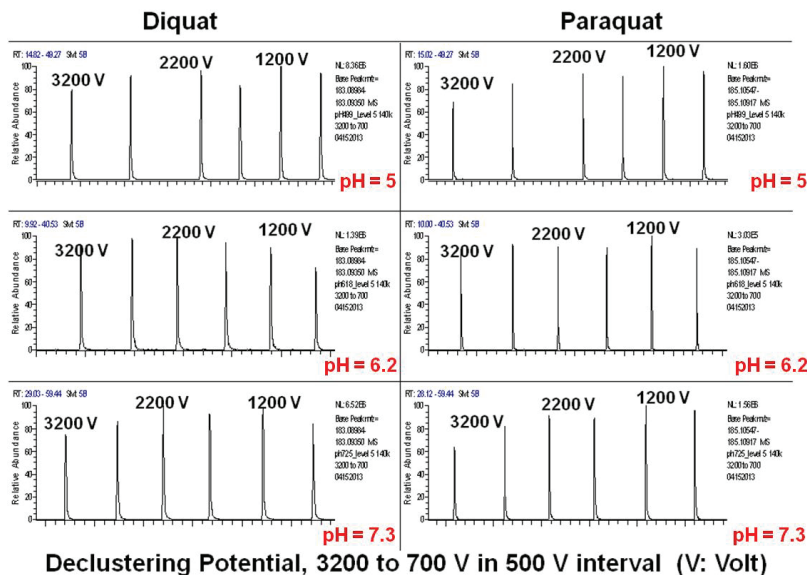

### Effect of mobile phase pH on the analysis of PQ and DQ

Table 1 lists accurate mass of the three possible quasi molecular ions of PQ and DQ, (i.e., molecular ion  $M^{2+}$ , deprotonated cation  $[M - H]^+$  and the singly charged radical ion  $[M]^{\cdot+}$ ), along with their respective  $^{13}C$ -isotope ( $M+1$ ) mass spectral peaks. Identification of PQ and DQ can be achieved by accurate mass of the three quasi molecular ions, their respective ( $M+1$ ) peak and fragment ions obtained from the AIF experiment.

TABLE 1. Expected  $m/z$  of PQ and DQ.

	$M^{2+}$	$M^{2+} (M+1)$	$[M^{2+} - H]^+$	$[M^{2+} - H]^+ (M+1)$	$[M]^{\cdot+}$	$[M]^{\cdot+} (M+1)$
Diquat	92.04948	92.55117	183.09167	184.09503	184.09950	185.10289
Paraquat	93.05730	93.55900	185.10732	186.11071	186.11515	187.11854

Figure 2 shows mass spectral peaks listed in Table 1 for PQ ( $[M^{2+} - H]^+$ ), A (simulated) and C (measured); DQ ( $[M]^{\cdot+} (M+1)$ ), B (simulated) and C (measured); DQ ( $[M^{2+} - H]^+ (M+1)$ ), D (simulated) and F (measured); DQ ( $[M]^+$ ), E (simulated) and F (measured); as well as DQ ( $[M^{2+} - H]^+$ ) and DQ ( $[M^{2+} - H]^+ (M+1)$ ), shown as simulated (G or H) and measured (I), as an example. It can be seen from Figure 1 that Orbitrap MS delivers excellent mass accuracy measurement and matched perfectly with those theoretically simulated ones (Figures 2A, 2B, 2D, 2E, 2G and 2H). Diquat has much better ESI ionization efficiency than PQ, with a mass spectral separation of < 25 ppm, the use of high resolution MS and a MEW < 5 ppm to separate these interfering peaks in the MS domain becomes imperative for the accurate determination of PQ.

Table 2 shows average area counts and relative standard deviation (RSD, N = 8) obtained from the LC analysis of PQ and DQ using mobile phases at three different pH values (i.e., 5, 6.2 and 7.3) and declustering potential (DP) of 2000 volts. The purpose of this experiment was to determine an optimal mobile phase pH that can be used in the LC separation of PQ and DQ.



**FIGURE 2. Simulated and measured mass spectral peaks of selected quasi molecular ions of PQ and DQ and their corresponding (M+1) peaks.**

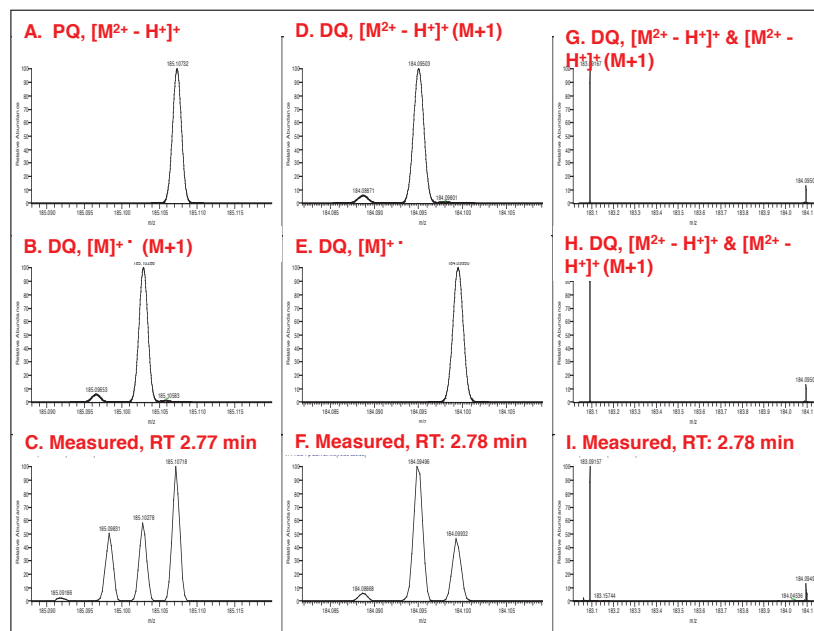

**TABLE 1. Average area counts, RSD (N = 8) and area ratios of the three molecular ions and their respective (M+1) ions.**

	Type of Ions	pH 5.0		pH 6.2		pH 7.3	
		Average	RSD	Average	RSD	Average	RSD
Diquat	[M] <sup>+</sup>	6.44E+05	8.9%	3.21E+05	11.2%	3.73E+05	6.6%
	[M] <sup>2+</sup> (M+1)	5.31E+04	16.4%	1.48E+04	27.8%	1.50E+04	44.6%
	M <sup>2+</sup>	1.21E+06	4.5%	4.16E+05	7.9%	7.34E+05	6.8%
	M <sup>2+</sup> (M+1)	1.39E+05	16.6%	1.48E+04	79.6%	5.75E+04	33.2%
	[M <sup>2+</sup> - H] <sup>+</sup>	1.72E+07	9.4%	3.88E+06	5.1%	7.78E+06	12.5%
	[M <sup>2+</sup> - H] <sup>+</sup> (M+1)	2.08E+06	7.2%	3.71E+05	11.1%	8.51E+05	9.2%
	Ratio [M] <sup>+</sup> (M+1)/[M] <sup>+</sup>	8.2%	-	4.6%	-	4.0%	-
	Ratio M <sup>2+</sup> (M+1)/M <sup>2+</sup>	11.5%	-	3.6%	-	7.8%	-
Paraquat	Ratio [M <sup>2+</sup> - H] <sup>+</sup> (M+1)/[M <sup>2+</sup> - H] <sup>+</sup>	12.1%	-	9.6%	-	10.9%	-
	[M] <sup>+</sup>	1.68E+06	5.4%	3.55E+05	11.8%	7.24E+05	3.9%
	[M] <sup>+</sup> (M+1)	1.67E+05	12.7%	2.43E+04	25.5%	5.73E+04	19.6%
	M <sup>2+</sup>	2.05E+06	6.4%	8.74E+05	12.7%	1.45E+06	7.5%
	M <sup>2+</sup> (M+1)	2.42E+05	7.4%	7.96E+04	13.7%	1.54E+05	12.4%
	[M <sup>2+</sup> - H] <sup>+</sup>	2.10E+06	2.8%	9.74E+05	4.0%	1.28E+06	4.1%
	[M <sup>2+</sup> - H] <sup>+</sup> (M+1)	2.43E+05	4.1%	9.57E+04	19.0%	1.27E+05	9.7%
	Ratio [M] <sup>+</sup> (M+1)/[M] <sup>+</sup>	9.9%	-	6.9%	-	7.9%	-
Ratio M <sup>2+</sup> (M+1)/M <sup>2+</sup>	11.8%	-	9.1%	-	10.6%	-	
Ratio [M <sup>2+</sup> - H] <sup>+</sup> (M+1)/[M <sup>2+</sup> - H] <sup>+</sup>	11.6%	-	9.8%	-	10.0%	-	

From Table 2, deprotonated cation [M - H]<sup>+</sup> of PQ and DQ gave the highest area counts and a good RSD followed by doubly-charged molecular ion [M]<sup>2+</sup> and radical ion [M]<sup>•+</sup> had the lowest area counts at all pH values. The deprotonated cation [M - H]<sup>+</sup> had the best SNR (and the highest area counts) at pH 5 mobile phase and was used in the analysis.

### Confirmation of PQ and DQ in UHPLC-Orbitrap MS analysis

From Table 2 at pH 5, LC retention time, accurate masses of the three molecular ion peaks (M) and their respective (M+1) peaks, area ratios obtained from the XIC of (M+1) and M peaks can be used to identify PQ and DQ. In addition, a CID experiment carried out via AIF can also be useful in producing product ion information that can be used for the confirmation of PQ and DQ. This is demonstrated in Figure 3 by using XICs obtained from *m/z* 169.07574 ([M - H] - CH<sub>3</sub> - H)<sup>+</sup> and *m/z* 153.07280 ([M - H] - CH<sub>3</sub> - HCN)<sup>+</sup> for PQ (Ref 4); and *m/z* 157.07593 ([M - H] - C<sub>2</sub>H<sub>2</sub>)<sup>+</sup> (Ref. 3) and *m/z* 130.06504 ([M - H] - C<sub>2</sub>H<sub>2</sub> - HCN)<sup>+</sup> for DQ analysis (Ref. 4).

**FIGURE 3. XICs obtained from product ions of PQ and DQ using AIF experiment for confirmation.**

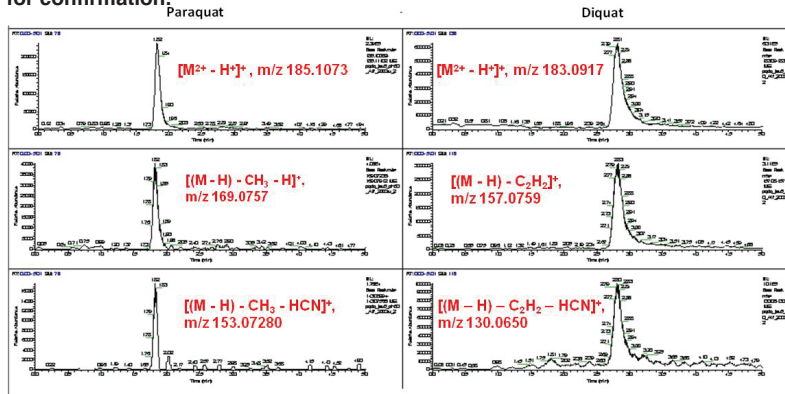

**FIGURE 4. Analytical Performance.**

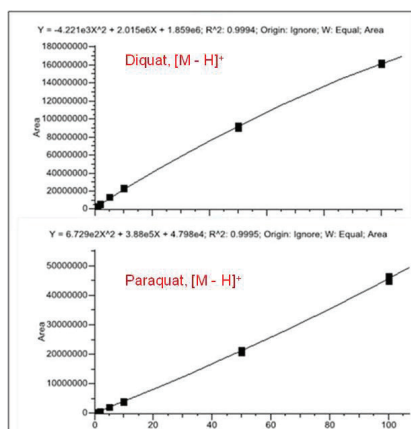

Using deprotonated  $[M - H]^+$  ion of PQ and DQ, we evaluated the linearity of the UHPLC Orbitrap MS system with seven levels of calibration standards in concentrations ranging from 0.5 to 100 mg/L. The calibration curve is shown in Figure 4 with good  $R^2 > 0.9990$  for both compounds.

Initial determination of MDL derived by using the U.S. EPA protocol was 0.05 and 0.15 mg/L for PQ and DQ. This direct injection method, when fully validated, would be able to provide high sensitivity analysis of PQ and DQ that will meet different DQO requirements of various jurisdictions.

## Conclusion

It is demonstrated that high-resolution and high-sensitivity analysis of PQ and DQ can be carried out using UHPLC Orbitrap MS coupled with an Acclaim Trinity Q1 column. This method provides the following benefits:

- A fast LC, isocratic separation of PQ and DQ in 5 min, without needing tedious sample preparation;
- Minimal interference and matrix effects in the analysis by using a MEW of 5 ppm;
- Identification and confirmation of PQ and DQ can be carried out using molecular ions of PQ and DQ, area ratios of M and (M+1) mass spectral peaks and product ions of from AIF experiment
- The method is sensitive and allowed the direct injection analysis of PQ and DQ with MDLs (0.05 and 0.15  $\mu\text{g/L}$  for PQ and DQ) meet the need of various regulatory bodies.

## References

1. J.E. Norman, K.M. Kuivila, L.H. Nowell, Scientific Investigations Report 2012–5045, U.S. Department of the Interior and U.S. Geological Survey, 2012.
2. K.C. Wang, S.M. Chen, J.F. Hsu, S.G. Cheng, C.K. Lee. J. Chromatogr. B 876 (2008) 211.
3. J.C. Marr, J.B. King, Rapid Commun. Mass Spectrom. 11 (1997) 479.
4. X.P. Lee, T. Kumazawa, M. Fujishiro, C. Hasegawa, T. Arinobu, H. Seno, A. Ishii, K. Sato, J. Mass Spectrom. 39 (2004) 1147.

[www.thermofisher.com](http://www.thermofisher.com)

©2016 Thermo Fisher Scientific Inc. All rights reserved. Microsoft Excel® are trademarks of Microsoft Corporation. All other trademarks are the property of Thermo Fisher Scientific, Inc. and its subsidiaries. Specifications, terms and pricing are subject to change. Not all products are available in all countries. Please consult your local sales representative for details.

**Africa-Other** +27 11 570 1840  
**Australia** +61 3 9757 4300  
**Austria** +43 1 333 50 34 0  
**Belgium** +32 53 73 42 41  
**Canada** +1 800 530 8447  
**China** +86 10 8419 3588  
**Denmark** +45 70 23 62 60

**Europe-Other** +43 1 333 50 34 0  
**Finland/Norway/Sweden**  
+46 8 556 468 00  
**France** +33 1 60 92 48 00  
**Germany** +49 6103 408 1014  
**India** +91 22 6742 9434  
**Italy** +39 02 950 591

**Japan** +81 45 453 9100  
**Latin America** +1 561 688 8700  
**Middle East** +43 1 333 50 34 0  
**Netherlands** +31 76 579 55 55  
**New Zealand** +64 9 980 6700  
**Russia/CIS** +43 1 333 50 34 0  
**South Africa** +27 11 570 1840

**Spain** +34 914 845 965  
**Switzerland** +41 61 716 77 00  
**UK** +44 1442 233555  
**USA** +1 800 532 4752

**Thermo**  
SCIENTIFIC

Part of Thermo Fisher Scientific



# Analysis of Dithiocarbamate Pesticides by GC-MS

Soma Dasgupta<sup>1,2</sup>, Sumaiyya Mujawar<sup>1</sup>, Kaushik Banerjee<sup>1</sup>, Hans-Joachim Huebschmann<sup>3</sup>

<sup>1</sup>National Research Center for Grapes, Pune, India, <sup>2</sup>Thermo Fisher Scientific, Mumbai, India,

<sup>3</sup> Thermo Fisher Scientific, Singapore

**Keywords:** Food safety, Dithiocarbamate fungicides, DTCs, Hydrolysis, Thiram, GC-MS, SIM

## Introduction

The class of dithiocarbamate fungicides (DTCs) is widely used in agriculture. They are non-systemic and both the formulation and their break-down products typically remain at the site of application. DTCs are characterized by a broad spectrum of activity against various plant pathogens, low acute mammal toxicity, and low production costs<sup>[1]</sup>. The dithiocarbamate moiety is highly reactive: it readily chelates most heavy metals, reacts with sulfhydryl groups of proteins, rendering itself neurotoxic, teratogenic, and cytotoxic.

DTCs are not stable and cannot be extracted or analyzed directly. Contact with acidic plant juices degrades DTCs rapidly and they decompose into carbon disulfide (CS<sub>2</sub>) and the respective amine<sup>[1]</sup>. It is not possible to homogenize plant samples and extract DTCs by organic solvents, as it is, for instance, with the QuEChERS standard procedure in pesticide-residue analyses. Maximum residue levels (MRLs) of DTCs are generally expressed as mg CS<sub>2</sub>/kg food.

Dithiocarbamates can be quantitatively converted to carbon disulphide by reaction with tin(II)chloride in

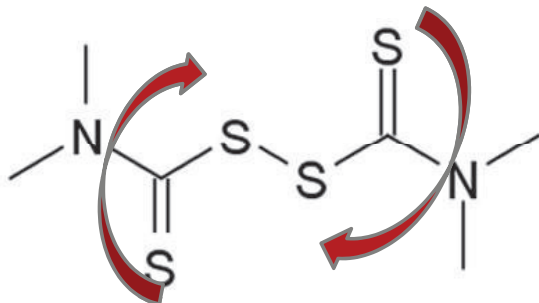

Figure 1. Thiram - 1 mole of Thiram generates 2 mole of CS<sub>2</sub>.



aqueous HCl (1:1) in a closed bottle at 80 °C. The CS<sub>2</sub> gas produced is absorbed into iso-octane and measured by GC-MS. The analysis of DTCs for this application follows the acid-hydrolysis method using SnCl<sub>2</sub>/HCl<sup>[2]</sup>. For method validation of the DTC pesticides, Thiram (99.5% purity) was used as representative bis (dithiocarbamate) compound considering its simple structure (1 mole of Thiram = 2 mole of CS<sub>2</sub> =>1 mg of Thiram theoretically generates 0.6333 mg CS<sub>2</sub>, 1 mL of 100 ppm Thiram in 25 g of grapes = 2.5 ppm of CS<sub>2</sub>); see Figure 1. The total DTC residues were estimated by analysing CS<sub>2</sub> as the DTC hydrolysis products by GC-MS. This is a non-specific DTC sum method that does not distinguish between the different species of DTCs in the sample. Interferences are known from natural precursors e.g. from crops or brassica, that can produce CS<sub>2</sub> as well during the hydrolysis<sup>[1,2]</sup>.

## Sample Preparation

A previously reported SnCl<sub>2</sub>/HCl acid-hydrolysis method was employed for sample preparation<sup>[3]</sup>. The described method follows the established methods applied in the EU reference laboratories and European commercial testing laboratories for CS<sub>2</sub> analysis. From the homogenized sample, 25 g are taken in a 250 mL glass bottle, 75 mL of the reaction mixture is added, followed by 25 mL iso-

octane. The bottle is closed immediately (gas-tight) and placed in a water bath at 80 °C for 1 h with intermittent shaking and inverting the bottle every 20 min. After cooling the bottle to < 20 °C by ice water, a 1-2 mL aliquot of the upper isooctane layer is transferred into a micro centrifuge tube, and centrifuged at 5000 rpm for 5 min at 10 °C. The supernatant is then transferred into GC vials, and the residues of DTCs are estimated by determining the CS<sub>2</sub> concentration by GC-MS. The sample preparation procedure depending on the type of food used takes approx. 1-2 hrs.

### Preparation of Standard Solutions and Reaction Mixture

For method validation, Thiram (99.5% purity) was used as representative DTC compound considering its simple structure (1 mole of Thiram = 2 mole of CS<sub>2</sub>).

#### Carbon disulphide standard solution

A stock solution of CS<sub>2</sub> (2000 µg/mL) was prepared by accurately pipetting out 79.0 µL of CS<sub>2</sub> into a volumetric flask (certified A class, 50 mL) containing approximately 45 mL of iso-octane and made up to 50 mL with iso-octane. The CS<sub>2</sub> stock solution was kept in a refrigerator at -20 °C and used within two days of preparation. The CS<sub>2</sub> working standard solutions of 200 and 20 µg/mL concentrations (10 mL each) were prepared by serial dilution of stock solution with iso-octane.

#### Standard Solution of Thiram

10 mg (± 0.05) of Thiram was weighed into a 10 mL volumetric flask (certified A class) and dissolved in ethyl acetate up to the mark to get a stock solution of 1000 µg/mL. A 100 µg/mL Thiram working standard was prepared from stock solution by 10-times dilution.

#### Preparation of Reaction Mixture

An amount of 30 g of tin (II) chloride was accurately weighed in the 1000 mL volumetric flask (certified A

class) to which 1000 mL of concentrated HCL (35%) was added. The solution was then gradually added to 1000 mL water with continuous stirring until a clear solution was obtained.

#### Calibration Standards

Calibration standard solutions of CS<sub>2</sub> at six different concentration levels (0.04, 0.08, 0.16, 0.32, 0.64, and 1.3 µg/mL) were prepared by appropriate dilutions of 20 µg/mL CS<sub>2</sub> working standard in iso-octane.

Matrix matched standards at the same concentrations were prepared by spiking the iso-octane extract of fresh control grapes, potato, tomato, green chili, and eggplant (all organically grown) using the following formula derived from above conversion of Thiram to CS<sub>2</sub>:

$$\text{Spike quantity} = \frac{\text{Concentration to be achieve} * \text{weight of the sample}}{0.6333 * \text{concentration of the stock solution}}$$

Before the preparation of matrix matched standards, the control samples were carefully monitored for absence of DTCs (in terms of CS<sub>2</sub>).

#### Experimental Conditions

A Thermo Scientific™ TRACE GC Ultra™ gas chromatograph equipped with Thermo Scientific™ Triplus™ RSH liquid autosampler and coupled to a Thermo Scientific™ ITQ™ 900 ion trap mass spectrometer was used for analysis. See Tables 1 and 2 for instrument parameters.

Two GC columns of different polarity, stationary phase, and film thickness have been evaluated. The first column was a medium polarity cyanopropylphenyl phase (6% cyanopropylphenyl/94% dimethyl polysiloxane, 30 m x 0.32 mm ID, 1.8 µm film thickness, e.g. Thermo Scientific™ TraceGOLD™ TG-624, p/n 26085-3390) and as a second column a low polarity 5%-phenyl stationary

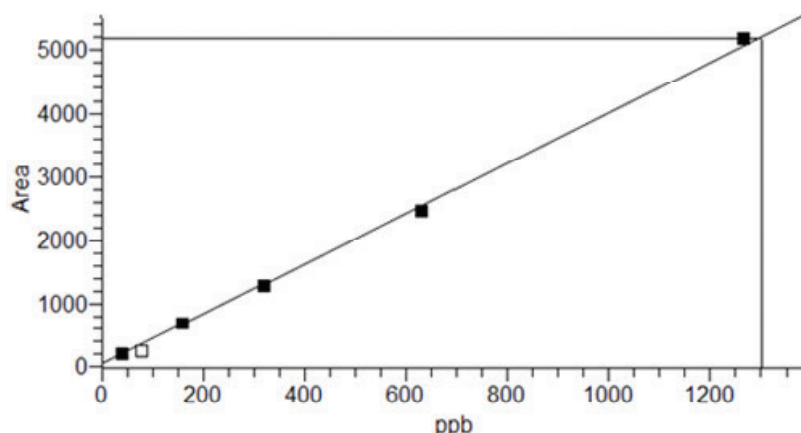

Figure 2. Calibration curve, range 0.04 - 1.300 µg/mL Thiram matrix spike, R<sub>2</sub> = 0.9990.



phase (5% diphenyl/95% dimethylpolysiloxane, 30 m x 0.25 mm ID, 0.25 µm film thickness, e.g. Thermo Scientific™ TraceGOLD™ TG-5MS p/n 26098-1420). The TG-624 column type is a mid-polarity column ideally suited for the analysis of volatile analytes, whereas

the TG-5MS column is more commonly used especially for pesticide analysis and is commonly available in all laboratories. Both columns were thus tested for the applicability of the method. Either column can be used for the DTC analysis.

Table 1. GC Conditions

<b>Injector, temperature prog.</b>	PTV-LVI
	40 °C, 0.1 min (injection phase, @ 100 kPa)
	10 °C/min to 80 °C, 0.3 min (@ 200 kPa)
	10 °C/min to 110 °C (transfer phase)
	14.5 °C/min to 290 °C (cleaning phase)
<b>Split flow</b>	20 mL/min
<b>Solvent vent</b>	open until 0.17 min
	closed until 4.17 min
	open until end of run
<b>Injection mode, volume</b>	split, 4 µL
<b>Carrier gas, flow</b>	Helium, constant flow 1 mL/min
<b>Oven program</b>	40 °C, 5 min
	40 °C/min to 200 °C
	200 °C, 5 min
<b>Transfer line temperature</b>	205 °C

Table 2. MS Conditions

<b>Ionization</b>	EI, 70 eV
<b>Scan mode, range</b>	SIM, $m/z$ 76, 78
<b>Acquisition rate</b>	2 scans/s
<b>Ion source temperature</b>	200 °C (optimized for CS <sub>2</sub> S/N ratio)

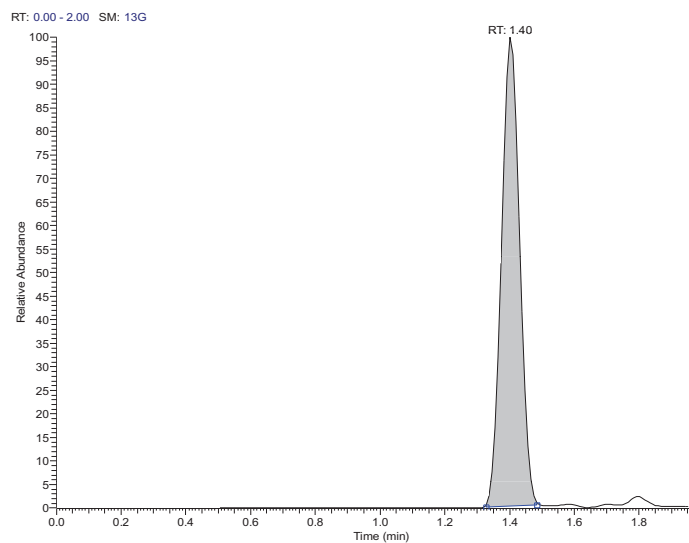

Figure 3. CS<sub>2</sub> chromatogram, 5 ppb matrix spike calibration.

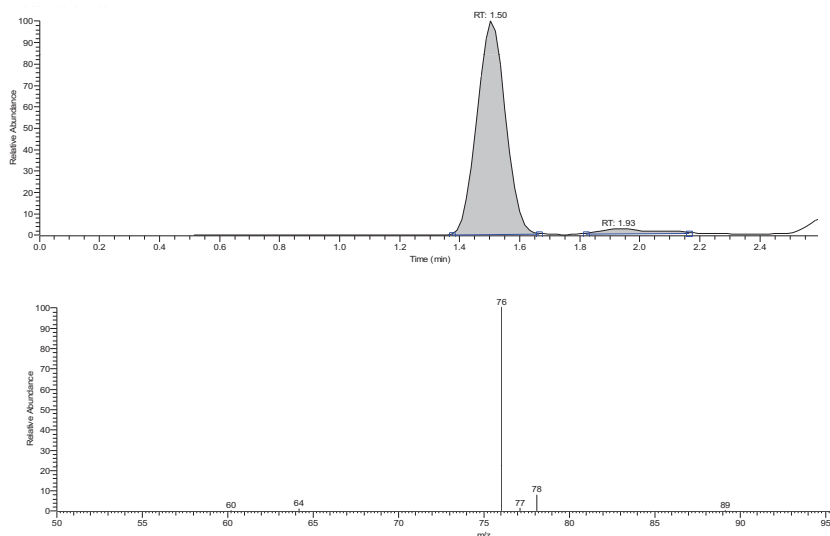

Figure 4. Chili sample analysis with confirming CS<sub>2</sub> ion ratio 100:10 for m/z 76:78.

### Sample Measurements

A typical GC-MS batch consisted of matrix-matched calibration standards, samples, one matrix blank and one recovery sample for performance check after a set of every six samples.

The data acquisition was carried out in Full Scan mode using the compound-specific ions *m/z* 76 and 78 (the 34S isotope, ion ratio 10:1) as extracted chromatograms for a selective identification of CS<sub>2</sub>.

### Results

#### Sensitivity

The sensitivity of the method was evaluated in terms of the limit of detection (LOD) and limit of quantification (LOQ) which were respectively 0.005 and 0.04 µg/mL. The LOD is the concentration at which the signal to noise ratio (*S/N*) for the quantifier ion is > 3, whereas LOQ is the concentration for which the *S/N* is > 10.

#### Recovery

The recovery experiments were carried out on fresh untreated potato, tomato, eggplant, green chili, and grapes by fortifying 25 g of the samples with Thiram solution at 0.04, 0.16, and 1.30 µg/g levels in six replicates. The control samples of each of the tested commodities were obtained from an organic farm near Pune, India, and screened for absence of DTC residues before spiking. The spiked samples were extracted using the sample preparation method described above. The quantitation of the residues was performed using matrix matched standards.

Table 3. Recoveries from different foods:

Spike level [ppb]	Grapes [%]	Chili [%]	Potato [%]	Egg plant [%]	Tomato [%]
1300	96 (±4)	81 (±10)	90 (±9)	90(±5)	81 (±4)
160	94 (±10)	80 (±13)	94 (±10)	92 (±8)	85 (±10)
40	104 (±15)	79 (±9)	104 (±15)	86 (±10)	96(±15)

## Precision

The precision of repeatability was determined by three analysts preparing six samples each on a single day. The intermediate precision was determined by the same analysts with six samples each on six different days. The method precision was determined with 0.04 mg/kg.

## General Guidelines for DTC Analysis

The analysis of cruciferous crops, including brassica samples, may not be unequivocal, because they contain naturally occurring compounds that may generate carbon disulfide.

It is necessary to avoid the use of rubber material (natural/synthetic) e.g. gloves, when performing DTC analyses as they contain dithiocarbamates, and this could lead to contamination problems. Silicone rubber and polyethylene do not contain dithiocarbamate.

Samples, other than fresh foodstuffs, will be comminuted by cryogenic milling. Fresh samples should be sub-sampled prior to extraction by removing segments from fresh samples following current Codex Alimentarius guidelines.

The samples should be analyzed within 4 weeks of cryogenic milling. If the storage of fresh produce is necessary it should be in a cool place (<-10°C) keeping condensation at minimum <sup>[4]</sup>.

## Conclusions

A reliable routine method for the analysis of dithiocarbamates with high precision in different vegetable and fruits has been developed. The method allows a wide calibration range of 0.04 – 1.300 µg/mL Thiram. The LOQ has been determined as 0.04 µg/mL.

The extraction uses a SnCl<sub>2</sub>/HCl acid-hydrolysis with iso-octane as solvent to form CS<sub>2</sub> which finally gets quantified by GC-MS. The recovery from different food commodities has been shown to be very high with 79 to 104%.

The GC injection method and column separation has been optimized for the injection of 4 µL of extract, using GC columns of standard film and dimensions, typically used for other types of residue analysis as well, so that a column change to a specific column for CS<sub>2</sub> determination only is not required.

The mass spectrometer ion source conditions had been optimized for best sensitivity and S/N ratio. The analysis in SIM mode is preferred providing a high selectivity with easy to integrate chromatograms.

This method has been developed initially for the ITQ ion trap mass spectrometer, but the same parameter setup is suitable for the Thermo Scientific™ ISQ™ series single quadrupole or Thermo Scientific™ TSQ™ Quantum XLS Ultra or Thermo Scientific™ TSQ 8000™ triple quadrupole mass spectrometers, as well.

## References

- [1] Crnogorac, G., Schwack, W., Residue analysis of dithiocarbamatefungicides, Trends in Analytical Chemistry, Vol. 28, No. 1, 2009.
- [2] Reynolds, S., Analysis of Dithiocarbamates, presented at the SELAMAT Workshop, Bangkok 2006.
- [3] Analysis of Dithiocarbamate Residues in Foods of Plant Origin involving Cleavage into Carbon Disulfide, Partitioning into Isooctane and Determinative Analysis by GC-ECD. [http://www.crl-pesticides.eu/library/docs/srm/meth\\_DithiocarbamatesCS2\\_EurlSrm.PDF](http://www.crl-pesticides.eu/library/docs/srm/meth_DithiocarbamatesCS2_EurlSrm.PDF)
- [4] Amvrazi, Elpiniki G., Fate of Pesticide Residues on Raw Agricultural Crops after Postharvest Storage and Food Processing to Edible Portions, Pesticides - Formulations, Effects, Fate, Prof. Margarita Stoytcheva(Ed.), ISBN: 978-953-307-532-7.

[www.thermoscientific.com](http://www.thermoscientific.com)

©2016 Thermo Fisher Scientific Inc. All rights reserved. All trademarks are the property of Thermo Fisher Scientific Inc. and its subsidiaries. This information is presented as an example of the capabilities of Thermo Fisher Scientific Inc. products. It is not intended to encourage use of these products in any manners that might infringe the intellectual property rights of others. Specifications, terms and pricing are subject to change. Not all products are available in all countries. Please consult your local sales representative for details.

**Africa-Other** +27 11 570 1840  
**Australia** +61 3 9757 4300  
**Austria** +43 1 333 50 34 0  
**Belgium** +32 53 73 42 41  
**Canada** +1 800 530 8447  
**China** +86 10 8419 3588  
**Denmark** +45 70 23 62 60

**Europe-Other** +43 1 333 50 34 0  
**Finland/Norway/Sweden**  
+46 8 556 468 00  
**France** +33 1 60 92 48 00  
**Germany** +49 6103 408 1014  
**India** +91 22 6742 9434  
**Italy** +39 02 950 591

**Japan** +81 45 453 9100  
**Latin America** +1 561 688 8700  
**Middle East** +43 1 333 50 34 0  
**Netherlands** +31 76 579 55 55  
**New Zealand** +64 9 980 6700  
**Russia/CIS** +43 1 333 50 34 0  
**South Africa** +27 11 570 1840

**Spain** +34 914 845 965  
**Switzerland** +41 61 716 77 00  
**UK** +44 1442 233555  
**USA** +1 800 532 4752

AN10333\_E 08/16S

**Thermo**  
S C I E N T I F I C  
Part of Thermo Fisher Scientific



# Simplifying Complex Multi-Residue Pesticide Methodology in GC-MS/MS

David Steiniger, Juan Carmona, Stacy Crain, Paul Silcock, and Jason Cole  
Thermo Fisher Scientific, Austin, TX, USA

## Key Words

Pesticide analysis, triple quadrupole GC/MS, AutoSRM, SRM, MRM

## Overview

### Easing Implementation of Multi-Residue Pesticide Methodology

The task of setting up a triple quadrupole GC/MS pesticide analysis can be daunting, regardless of your starting point. Perhaps you are brand new to GC/MS pesticide analysis, and you need all the help you can get. Maybe you analyze a small set of pesticides and want to expand your target list, or you analyze a large pesticide set in multiple runs on a single quadrupole and want to combine these into a single MRM analysis. Perhaps you already have a comprehensive MRM method, but want to move this to a Thermo Scientific™ TSQ™ 8000 triple quadrupole GC-MS/MS system to take advantage of its robustness, removable ion source under vacuum, and its ease in adding new target pesticides through AutoSRM. Whatever your starting point, when adopting new technology to address complex analytical challenges, you need tools that enable you to be productive, quickly.

With your needs and requirements in mind, the Thermo Scientific TSQ 8000 Pesticide Analyzer (Figure 1) has been developed. Provided within this comprehensive package are all the tools you need to set up a complex pesticide method, regardless of your starting point.

Everyone who is new to pesticide analysis on the TSQ 8000 GC-MS/MS system will appreciate the provided list of optimized pesticide transitions. Also, with an easy to follow step-by-step description of how to develop new transitions using AutoSRM, you'll find the ease of adding new pesticides to your MRM method is now a competitive advantage for your laboratory. And for those who need more assistance, the TSQ 8000 Pesticide Analyzer contains a complete instrument method developed on an included column with provided compound retention times and MRM parameters—eliminating days, if not weeks, of method development.



Figure 1. The TSQ 8000 Pesticide Analyzer. Details of its contents can be found in the *TSQ 8000 Pesticide Analyzer Brochure (BR10318)*.

In addition to simplified method startup, another advantage of using the analyzer is that it utilizes Timed-SRM methodology, allowing for easy-to-use, high-analyte-capacity methodology. The usability and scanning efficiency of Timed-SRM are complemented by the fast-scanning capability of the TSQ 8000 instrument, making the analysis of hundreds of pesticides, with a total of over one thousand transitions, not just possible, but easy.

Finally, the TSQ 8000 Pesticide Analyzer has the ability to analyze full scan data at the same time as your targeted MRM analysis. This allows you to harness the power of existing EI full scan libraries to, for example, find potential high-level contaminants you would otherwise miss in a targeted analysis, or monitor the matrix background for possible interference.

## Using the Startup Kit

### Starting Point 1: Starting from Scratch

When creating your method within Thermo Scientific™ TraceFinder™ EFS software, the instrument control and data processing software included with the TSQ 8000 Pesticide Analyzer, the use of the TraceFinder Pesticide Compound Database (CDB) will greatly simplify the method development process. Multiple transitions for each compound in the database have been optimized on the TSQ 8000 instrument with AutoSRM to within  $\pm 1$  eV of the optimum collision energy.

Simply select the compounds of interest in the CDB (Figure 2). This will create not only the TraceFinder software processing method, but also the TSQ 8000 mass spectrometer acquisition list. Since the instrument employs Timed-SRM, SRM windows for data acquisition will be centered on your retention times, so that all peaks elute far from acquisition-window breaks. The complete step-by-step procedure, including software screen captures, is detailed in the *TSQ 8000 Pesticide Analyzer Installation Guide*, which is also included with the TSQ 8000 Pesticide Analyzer.

After selecting your compounds of interest, you are now ready to acquire samples in MRM with your TSQ 8000 instrument.

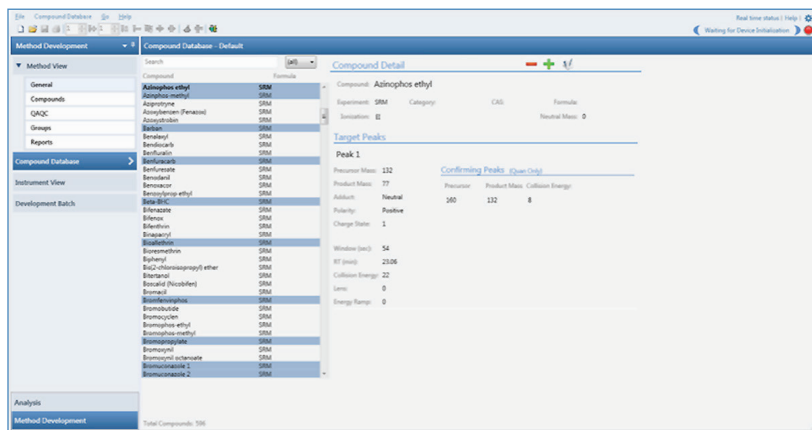

Figure 2. Selecting compounds from the TraceFinder EFS Compound Data Base. This will populate both your TraceFinder Processing Method and your acquisition list. For more information on creating TSQ 8000 methods with the TraceFinder CDB, see *AB52300: Thermo Scientific TSQ 8000 GC-MS/MS Method Sync*.

### Starting Point 2: Starting from an Established GC Method

If you already have a preferred GC method, and know the retention times of your target compounds, you can update the pesticides in the CDB with the known retention times. Next, simply select the compounds you are interested in analyzing from the updated CDB, as shown in Figure 2. Again, this will create both the TraceFinder EFS processing method and the TSQ 8000 system Timed-SRM acquisition list, with acquisition windows centered on the retention times of the target peaks.

If you do not know exact retention times, you can easily widen acquisition windows while in TraceFinder EFS software for all compounds (Figure 3) to ensure your peaks fall within their acquisition window. Now update your TraceFinder EFS software method with the new retention times as you would in a normal data review, and your acquisition windows will be centered on each compound. After updating the retention times, follow the same step to reduce acquisition windows back to defaults in order to maximize dwell time for the analysis.

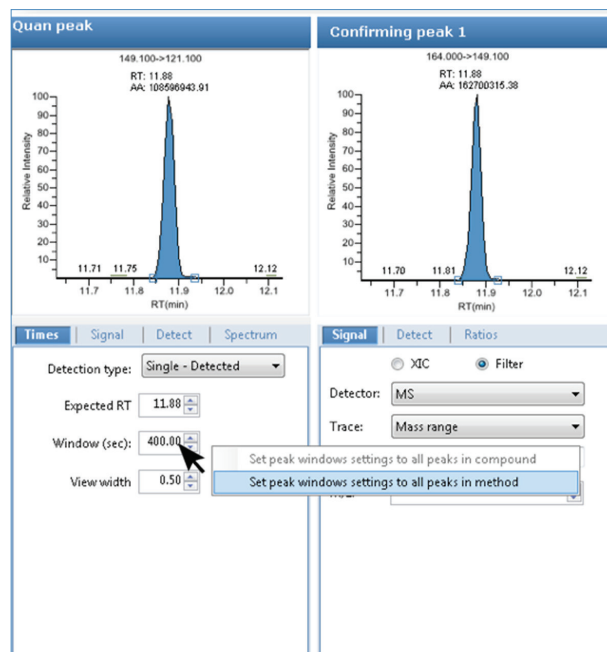

Figure 3. Widening acquisition windows in TraceFinder EFS software to find peaks with unknown retention times.



## Tools to Get You Productive

The software features of the TSQ 8000 system have been designed with complex pesticide analysis in mind. These features include AutoSRM, a tool that makes the instrument the easiest for developing and adding new compounds to an existing pesticide method. Another useful feature is Timed-SRM, which enables accurate pesticide identification and quantitation, even for very dense pesticide methodologies. Finally, the ability of the TSQ 8000 instrument to perform simultaneous full scan/MRM provides the capability to identify general unknowns in conjunction with your target pesticides, filling a classic gap in targeted MRM analysis.

## Addition of New Compounds

For those compounds provided in the TSQ 8000 Pesticide Analyzer CDB, the addition of new compounds to your methodology is extremely simple. If you are using the method and GC column provided with the TSQ 8000 Pesticide Analyzer, simply select additional compounds to your method from the CDB. The instrument software now adds the selected compounds to both the method acquisition list and the TraceFinder EFS software processing list with the correct retention times.

For those pesticides not yet in the TSQ 8000 Pesticide Analyzer CDB, AutoSRM can be used to quickly develop these new transitions (Figure 4). Once fully developed, the new compounds are easily imported into the CDB and added to your TraceFinder software method. A step-by-step walkthrough of this is described in detail in the *TSQ 8000 Pesticide Analyzer Installation Guide*, which is provided as part of the TSQ 8000 Pesticide Analyzer package. For more details on how AutoSRM works, see *AB52298: Introducing AutoSRM*.

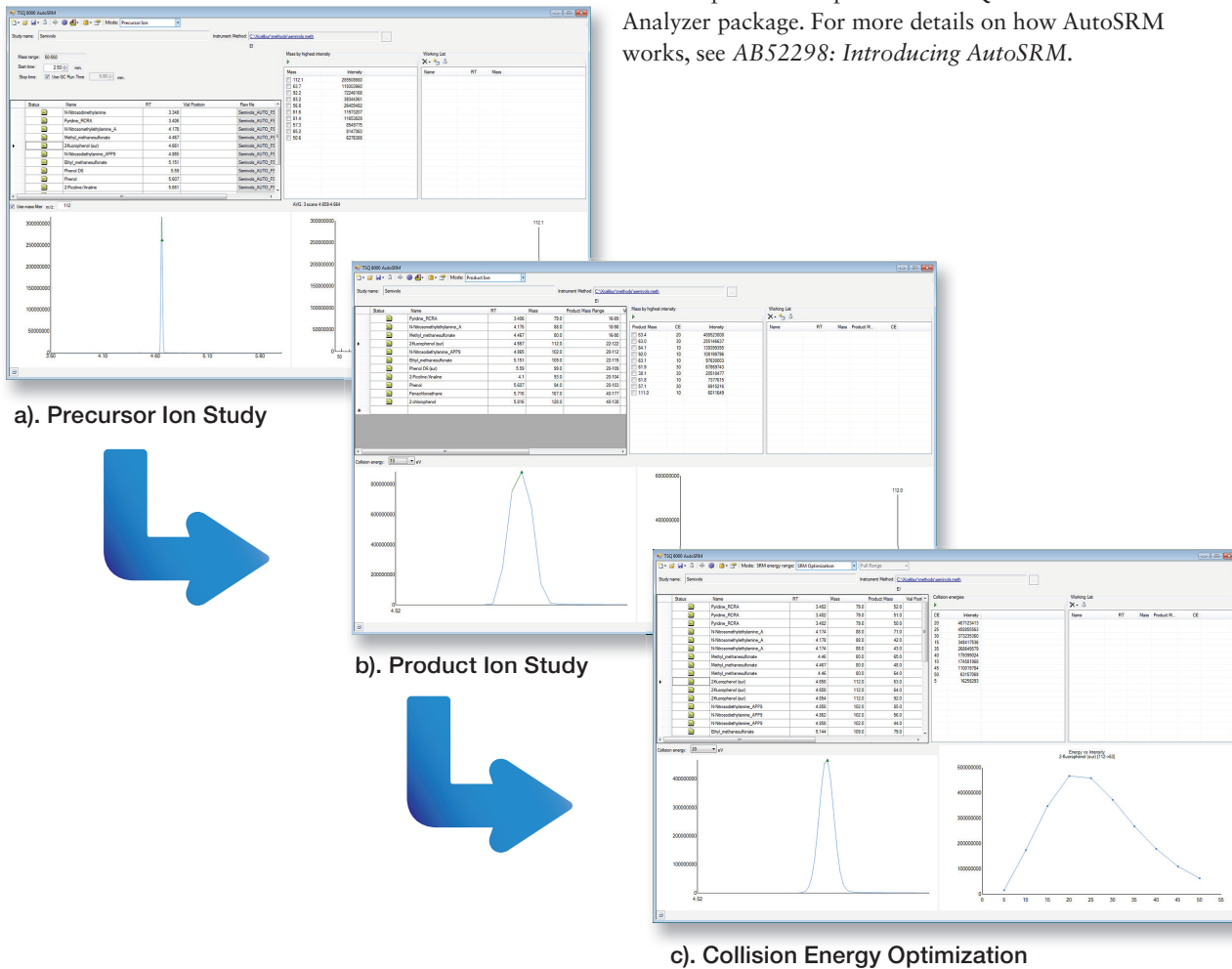

Figure 4. Screen shots showing the three-step process of AutoSRM. a.) In the first step, AutoSRM acquires full scan data for selecting precursor ions. b.) In the second step, product ions are selected from product ion scan data. c.) In the final step, collision energies are varied for each of the selected SRM's to determine the optimal collision energy.

## High Compound Capacity Methods

One of the primary challenges of modern pesticide analysis is the sheer number of pesticides that need monitoring in order to meet international standards. This is particularly true in food analysis where products are transported across country borders, requiring exporters to meet the regulatory demands of many countries. Triple quadrupole instruments help meet this demand due to the high selectivity of MRM analysis, which allows for spectral separation of coeluting peaks due to unique reactions in the collision cell. This enables monitoring of more compounds in a single chromatographic run without prohibitive interference. However, due to the targeted nature of the MRM process, individual scan events must be created for each pesticide to be monitored, placing a strain on the amount of time devoted to the monitoring of each compound, and thus the sensitivity of the analysis of each compound.

With a traditional style analysis, this issue can be partially resolved by slicing up the acquisition list into discreet time segments, so that all transitions are not being monitored at the same time. However, this can quickly lead to problems when analyzing more than 50 pesticides in one run. This is because, due to the density of the peaks in the heart of the method, it is difficult to find a time for a segment break when no target peaks are eluting.

This then forces a compromise between adding many compounds per segment, reducing individual SRM dwell times and sensitivity, and adding segment breaks between closely eluting peaks, which causes the risk of false negatives due to shifts in peak retention times outside of acquisition windows because, for example, a large bit of matrix coelutes with a peak.

The TSQ 8000 system takes an approach called Timed-SRM that eliminates this compromise. Timed-SRM removes the limitations of segmented SRM by centering acquisition windows on the retention time of each peak and allowing for acquisition window overlap, so that acquisition windows for all nearby eluting compounds are not forced to start and stop at the same time (Figure 5). The user simply needs to enter the retention time of each compound, and the instrument method takes care of the rest, eliminating the need for creating segments.

Acquisition windows centered around retention time

Acquisition windows allowed to overlap

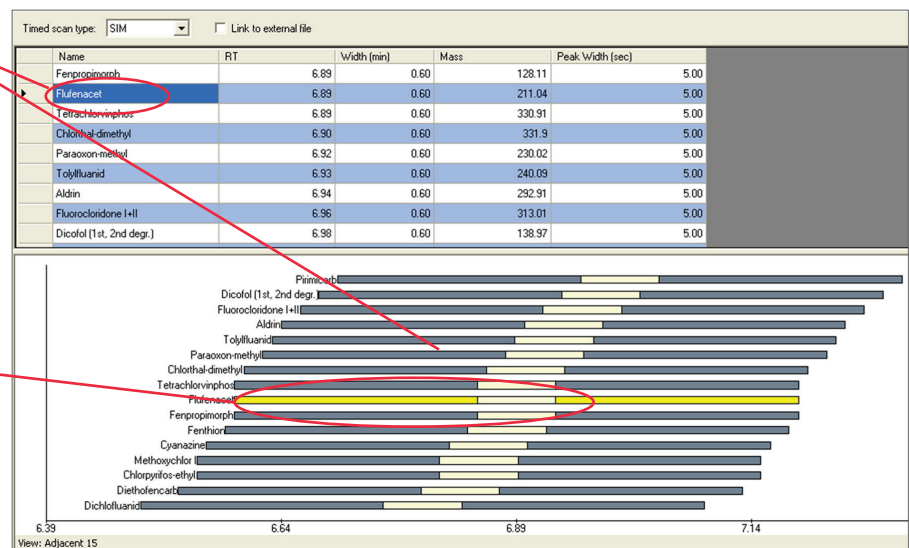

Figure 5. The TSQ 8000 system Timed-SRM Acquisition list, showing SRM acquisition windows centered on retention times and overlapping nearby transitions.

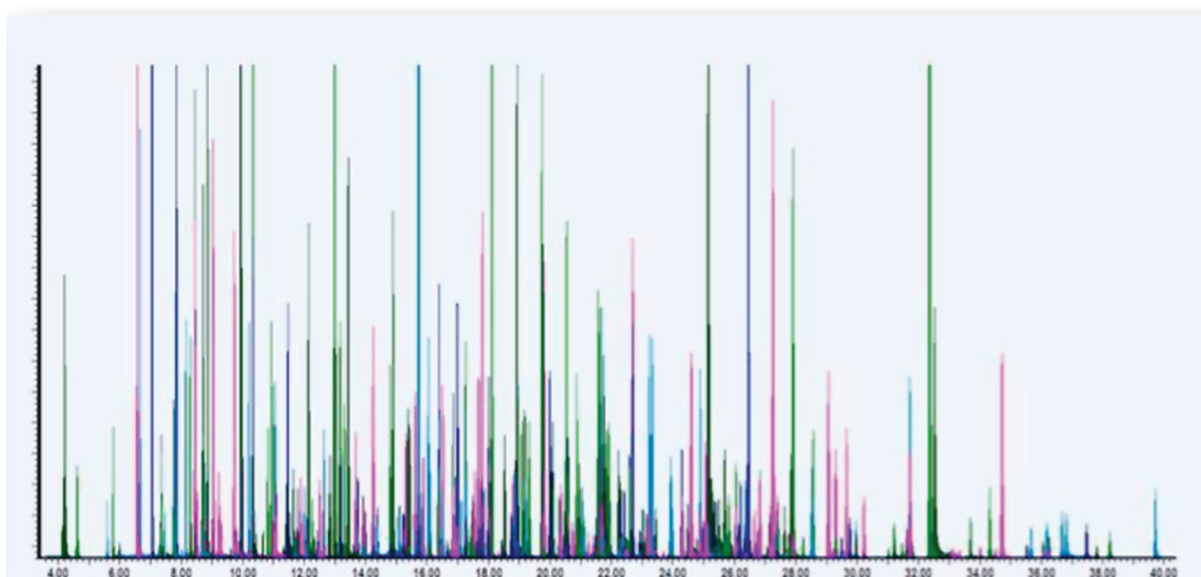

Figure 6. Real-world acquisition of over 300 pesticides in a single chromatographic run using Timed-SRM.

Figure 6 shows a real-world example of a pesticide analysis of over 300 compounds using Timed-SRM. As shown in the Table 1 comparison with Segmented-SRM, Timed-SRM increases both the sensitivity of the analysis

by reducing the number of transitions being acquired simultaneously and the time between when target peaks elute and when their acquisition window begins or ends.

Table 1. Comparison of Segmented-SRM vs. Timed-SRM for method of over 300 pesticides. Timed-SRM can dramatically reduce the average number of transitions occurring simultaneously, while increasing the minimum time between an eluting peak and an acquisition window break.

	Segmented-SRM	Timed-SRM
Average number of simultaneous transitions during run	55 Transitions	15 Transitions
Shortest time interval between a compound retention time and an acquisition window break	5 Seconds	15 Seconds

## General Unknown Screening

Another limitation of the classic MRM approach to pesticide analysis is that, due to its targeted nature, if a compound is not part of your target list, you are not going to find it, even if it is present in large quantities in your sample. This limitation is removed with capability of the TSQ 8000 system to perform simultaneous full scan/ MRM.

The TSQ 8000 system allows you to set up a full scan acquisition throughout the duration of your MRM analysis. Each acquisition will then have full scan data to identify non-target compounds, in addition to MRM data to confirm and quantitate the target list. This mode of analysis is facilitated with the TraceFinder EFS software qualitative processing view within its standard quantitative batch analysis, which automatically detects, identifies, and reports non-target compounds (Figure 7).



Figure 7. Qualitative view of TraceFinder EFS software for analyzing fruit juice with simultaneous full scan/ Timed-SRM on the TSQ 8000 system. In addition to quantitating and confirming the 158 target compounds by MRM (top), TraceFinder EFS software has identified three high-level unknowns by full scan analysis (bottom): 2,4-bis(1,1-dimethylethyl)-phenol, triethyl citrate, and Vitamin E.

## Conclusion

For the lab just starting up a complex pesticide analysis by triple quadrupole GC-MS, the TSQ 8000 Pesticide Analyzer offers the easiest and quickest path to success. The included methodology, consumables, and SRM transition list with accurate retention times enable the creation of your pesticide method to be as simple as selecting the compounds you want to analyze. With multiple SRM transitions per compound optimized to within  $\pm 1$  eV, the pesticide analyzer is useful for anyone who wants to take advantage of the unique features of the TSQ 8000 system designed to make complex pesticide analysis simple.

The TSQ 8000 Pesticide Analyzer fully takes advantage of these features, including the ability to do Timed-SRM, which significantly increases low-level sensitivity through a more efficient SRM scheduling. Also, the full scan/MRM capability of the TSQ 8000 mass spectrometer combines the elite quantitation capabilities of MRM analysis with classic general unknown identification through full scan quadrupole library searching. Finally, the ability to easily develop and add new pesticides to an existing pesticide method through AutoSRM makes the TSQ 8000 Pesticide Analyzer the most flexible system for expanding your pesticide target list to meet future regulatory or client demands.

[www.thermofisher.com](http://www.thermofisher.com)

©2016 Thermo Fisher Scientific Inc. All rights reserved. All trademarks are the property of Thermo Fisher Scientific Inc. and its subsidiaries. This information is presented as an example of the capabilities of Thermo Fisher Scientific Inc. products. It is not intended to encourage use of these products in any manners that might infringe the intellectual property rights of others. Specifications, terms and pricing are subject to change. Not all products are available in all countries. Please consult your local sales representative for details.

<b>Africa-Other</b> +27 11 570 1840	<b>Europe-Other</b> +43 1 333 50 34 0	<b>Japan</b> +81 45 453 9100	<b>Spain</b> +34 914 845 965
<b>Australia</b> +61 3 9757 4300	<b>Finland/Norway/Sweden</b> +46 8 556 468 00	<b>Latin America</b> +1 561 688 8700	<b>Switzerland</b> +41 61 716 77 00
<b>Austria</b> +43 1 333 50 34 0	<b>France</b> +33 1 60 92 48 00	<b>Middle East</b> +43 1 333 50 34 0	<b>UK</b> +44 1442 233555
<b>Belgium</b> +32 53 73 42 41	<b>Germany</b> +49 6103 408 1014	<b>Netherlands</b> +31 76 579 55 55	<b>USA</b> +1 800 532 4752
<b>Canada</b> +1 800 530 8447	<b>India</b> +91 22 6742 9494	<b>New Zealand</b> +64 9 980 6700	
<b>China</b> +86 10 8419 3588	<b>Italy</b> +39 02 950 591	<b>Russia/CIS</b> +43 1 333 50 34 0	
<b>Denmark</b> +45 70 23 62 60		<b>South Africa</b> +27 11 570 1840	

TN10319\_E 08/16S

**Thermo**  
SCIENTIFIC





# Analysis of Glyphosate and AMPA in Environmental Water by Ion Chromatography Electrospray Tandem Mass Spectrometry (IC-ESI-MS/MS)

Charles Yang<sup>1</sup>, Stacy Henday<sup>2</sup>, Leo Wang<sup>2</sup>, and Bill Schnute<sup>2</sup>

<sup>1</sup>Thermo Fisher Scientific, San Jose, CA; <sup>2</sup>Dionex Corporation, Sunnyvale, CA

## Introduction

Glyphosate [N-(phosphonomethyl) glycine] is a nonselective herbicide that inhibits the shikimic acid pathway in plants. Glyphosate is the most commonly used agricultural pesticide and the second most used pesticide around homes and gardens.<sup>1</sup> It is applied to control woody and herbaceous weeds in forestry, cropped, and non-cropped sites. Although the bacteria in soil break down glyphosates into aminomethylphosphonic acid (AMPA), wastewater discharge samples and drinking water samples in the United States and Europe have tested positive for glyphosate.<sup>2-4</sup> Studies have raised global health and environmental concerns about the usage of glyphosate.<sup>5</sup> In 2006, the US EPA set the minimum contaminant level (MCL) for glyphosate at 0.7 mg/L.<sup>6</sup> Long-term exposure to glyphosate at levels above the MCL may cause kidney damage and reproductive defects in human biological systems.

The U.S. EPA established Method 547 for the determination of glyphosate in drinking water by direct aqueous injection high pressure liquid chromatography (HPLC), post-column derivatization, and fluorescence detection. Other methods for the quantitation of glyphosate typically use preliminary derivatization or solid-phase extraction (SPE) followed by post-column derivatization. Silica-based reversed-phase C18 columns, which use cation-exchange mechanisms, experience difficulty with the retention of such polar compounds. Here, we present a two-dimensional technique that separates glyphosate and AMPA by using anion-exchange columns coupled to a triple stage quadrupole mass spectrometer. This system eliminates the need for derivatization and preparation of complex mobile phases.

## Goal

To develop an ion chromatography-mass spectrometry (IC-MS/MS) method to separate and quantitate glyphosate and AMPA without derivatization or preparation of complex mobile phases.

## Experimental Conditions

### Ion Chromatography

IC analysis was performed on a Dionex ICS 3000 ion chromatography system (Dionex Corporation, Sunnyvale, CA). Samples were directly injected and no sample pretreatment was required. The IC conditions used are as follows:

#### First Dimension

Column set:	IonPac® AG19 (2.1 × 50 mm) / AS19 (2.1 × 250 mm); guard and separator columns (Dionex) IonPac UTAC (3 × 50 mm) Ultratrace anion concentrator column (Dionex)
Suppressor:	ASRS® 300, 2 mm; operated at 30 mA (Dionex)
Column temperature:	30 °C
Injection volume:	200 µL
Mobile phase:	Potassium hydroxide, electrolytically generated with an EGC-KOH cartridge
Gradient:	0–12 min: 8 mM KOH 12–16 min: 8–40 mM KOH 16–21 min: 40 mM KOH
Flow rate:	300 µL/min

#### Second Dimension

Column set:	IonPac AG21 (2.1 × 50 mm) / AS21 (2.1 × 250 mm); guard and separator columns (Dionex) Suppressor: ASRS 300, 2 mm; operated at 48 mA (Dionex)
Column temperature:	35 °C
Mobile phase:	Potassium hydroxide, electrolytically generated with an EGC-KOH cartridge
Gradient:	0–20 min: 1 mM KOH 20–30 min: 1–40 mM KOH 30–35 min: 40 mM KOH
Flow rate:	300 µL/min

## Key Words

- TSQ Quantum Access
- Ion chromatography
- EPA
- Herbicides
- Water analysis

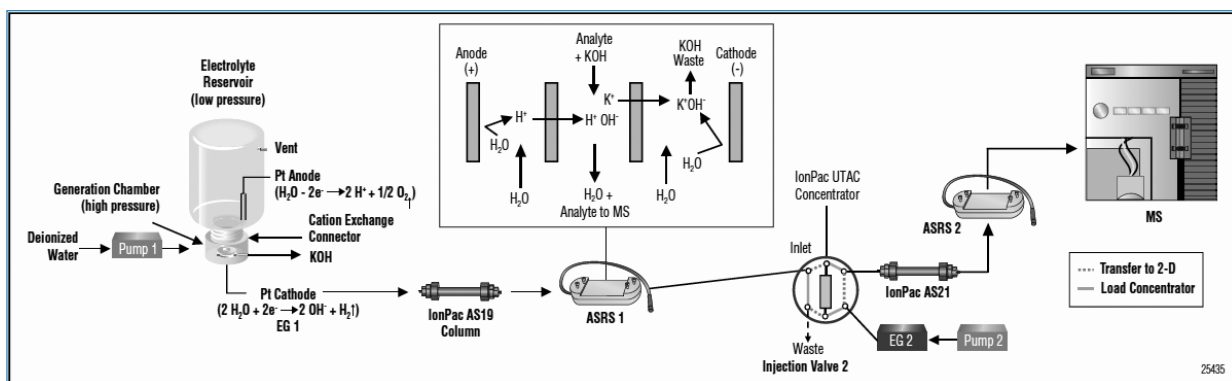

Figure 1. The flow schematic for a two-dimensional IC-MS/MS application. The first dimension separates the analytes of interest from a majority of the matrix ions. The second dimension improves peak shape and keeps the source of the MS clean.

The high-purity IC eluent is automatically produced in situ (Figure 1). The pump delivers water to an eluent generator cartridge (EGC) that converts the water into the selected concentration of potassium hydroxide eluent using electrolysis. After separation on the column, the eluent enters the anion self-regenerating suppressor (ASRS) that produces hydronium ions to exchange with potassium in the eluent. This makes the mobile phase compatible with the mass spectrometer liquid inlet system.

### Mass Spectrometry

MS analysis was carried out on a Thermo Scientific TSQ Quantum Access triple stage quadrupole mass spectrometer with an electrospray ionization (ESI) source. The MS conditions were as follows:

Ion source polarity:	Negative ion mode
Spray voltage:	3000 V
Sheath gas pressure:	40 arbitrary units
Ion sweep gas pressure:	1 arbitrary unit
Auxiliary gas pressure:	2 arbitrary units
Capillary temperature:	400 °C
Collision gas pressure:	1.5 bar
Scan conditions:	Table 1

Table 1. MS Scan Conditions

Compound	Mass	Scan Width	Scan Time (s)	Collision Energy	Tube Lens
AMPA	110.17 / 63.3	0.01	0.5	19	60
AMPA	110.17 / 79.2	0.01	0.5	35	60
Glyphosate	168.09 / 150.1	0.01	0.5	13	51
Glyphosate	168.09 / 79.4	0.01	0.5	40	51

### Results and Discussion

The major matrix peaks of chloride, nitrate, carbonate, and sulfate were well-resolved. The separation of all compounds occurred in both dimensions in 30 minutes. The calibration curves showed excellent linearity using only external quantitative measurements without internal standards.

For quantitation, samples were run in the MS/MS selective reaction monitoring (SRM) mode on the TSQ Quantum Access™ triple stage quadrupole instrument. The calibration range was 0.1–50 ppb for AMPA and 0.05–50 ppb for glyphosate. The correlation coefficients ( $R^2$ ) of the 110 → 63 and 110 → 79 SRM transitions of AMPA were both 0.9997 (Figures 2 and 3). The 168 → 150 transition of glyphosate had an  $R^2$  of 0.9997 and the 168 → 79 transition yielded an  $R^2$  of 0.996 (Figures 4 and 5, respectively).

The minimum detection limit (MDL) in matrix was calculated by seven replicate injections of 5 ppb in a simulated matrix with high concentrations of chloride, carbonate, nitrate, and sulfate (250 ppm chloride and sulfate, 150 ppm sodium bicarbonate, 20 ppm nitrate). The MDLs for AMPA and glyphosate were calculated by using the equation  $MDL = t_{99\%} \times S_{(n-1)}$ , where  $t$  equals the Student's  $t$  test at 99% confidence intervals ( $t_{99\%, (6)} = 3.143$ ) and  $S$  is the standard deviation. The calculated MDL for AMPA was 0.313 ppb and 0.252 ppb for glyphosate. This is well below the current MDLs of 6 ppb for glyphosate in reagent water and 8.99 ppb in ground water specified by the EPA guidelines found in Method 547.

Using ion chromatography to quantitate AMPA and glyphosate accurately at this level without sample pretreatment requires the use of a mass spectrometer. However, the source of the instrument can be subject to fouling from routine analysis of samples of high-ionic strength. The use of multi-dimensional chromatography significantly reduces the introduction of matrix ions to the mass spectrometer, increasing the method robustness in challenging sample matrices. The recoveries for AMPA and glyphosate were 97.2% and 82.1%, respectively, for 5 ppb spiked into high-ionic strength samples. The relative standard deviations were less than 5% for both compounds, even without an internal standard (Figure 6).

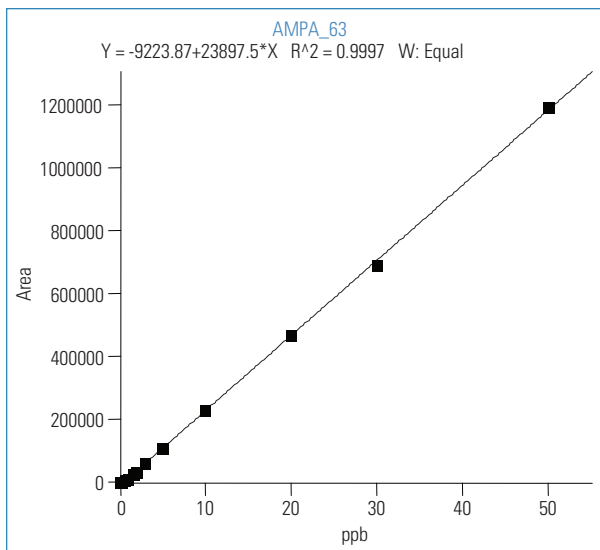

Figure 2. Calibration curve of the 110 → 63 SRM transition for AMPA.

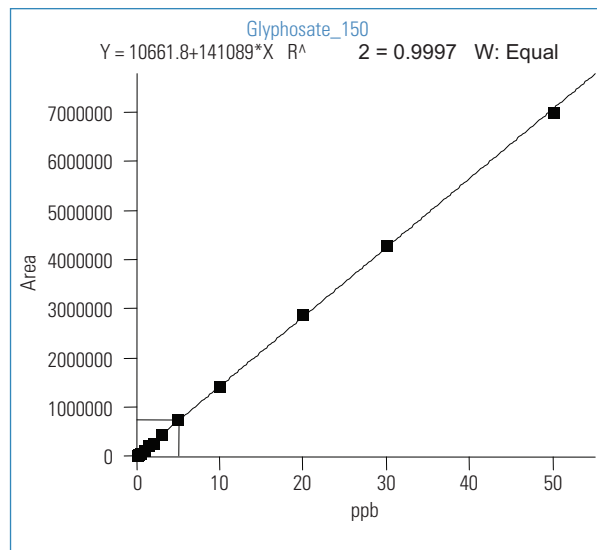

Figure 4. The calibration curve of the SRM 168 → 150 for glyphosate.

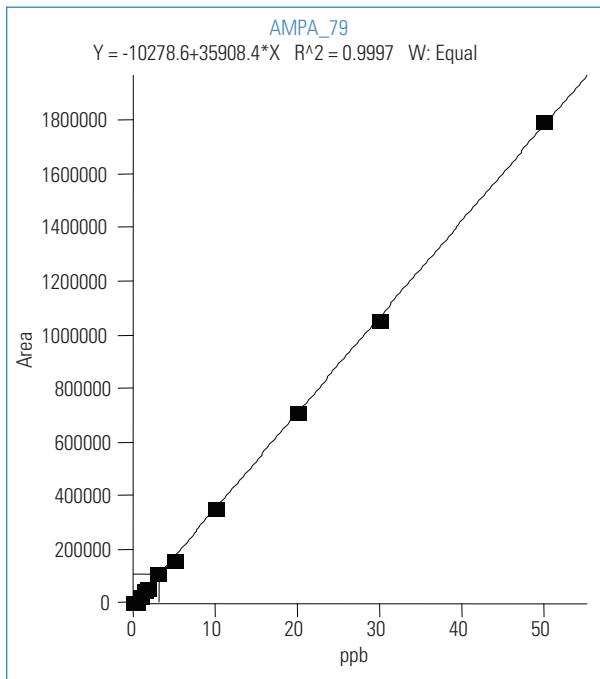

Figure 3. The calibration curve of the SRM 110 → 79 for AMPA.

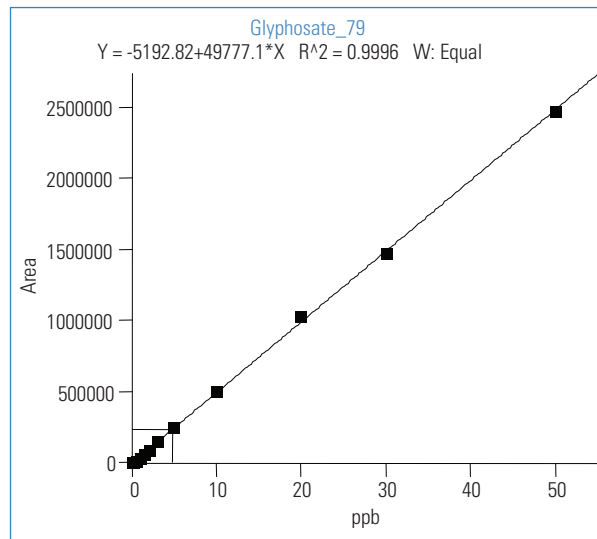

Figure 5. The calibration curve of the SRM 168 → 79 for glyphosate.

The response of the standards decreased over time. However, when using freshly prepared standards, the response remained constant; this suggests there may be temperature stability issues with the samples. Although excellent short-term (30 hour) stability yielded standard deviations less than 5%, using a refrigerated autosampler and an isotopically-labeled internal standard will help minimize systematic sample degradation and response variation.

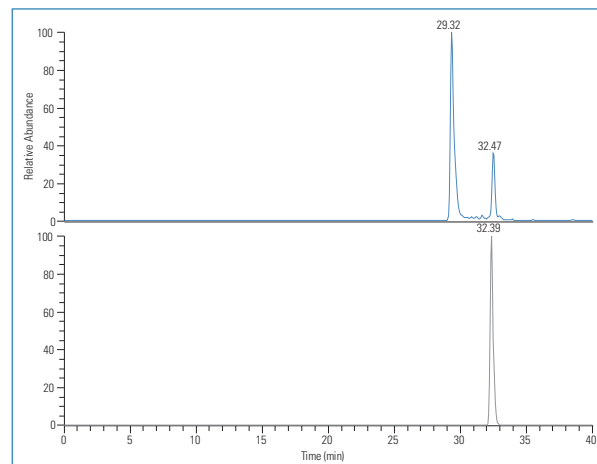

Figure 6. The total ion chromatogram (TIC) of 5 ppb of glyphosate and AMPA spiked into a matrix of chloride, nitrate, carbonate and sulfate.

## Conclusion

The advantage of the IC-MS/MS methodology described here is the elimination of derivatization and acidification steps required by EPA Method 547 and other techniques. The analysis requires no sample preparation. Separation of both compounds in both dimensions occurs in approximately 30 minutes. Calibration levels of 0.05 to 50 ppb for glyphosate show that this method can be used to quantitate low (ppb) levels of glyphosate in high-ionic strength matrices. Using stable-labeled internal standards will help compensate for the effects of ion suppression in the source.

## References

1. Tu, M.; Hurd, C.; and Randall, J.M. Weed Control Methods Handbook, The Nature Conservancy, <http://tncinvasives.ucdavis.edu>, Version: April 2001.
2. United States Geological Survey, "Glyphosate Found in Wastewater Discharged to Streams," [http://toxics.usgs.gov/highlights/glyphosate\\_wastewater.html](http://toxics.usgs.gov/highlights/glyphosate_wastewater.html) (Accessed January 7, 2009).
3. Kolpin, D.W.; Thurman, E.M.; Lee, E.A.; Meyer, M.T.; Furlong, E.T.; and Glassmeyer, S.T. "Urban contributions of glyphosate and its degradate AMPA to streams in the United States"; Science of the Total Environment, 2006, 354 (2-3), 191-197. doi: 10.1016/j.scitotenv.2005.01.028
4. Beyond Pesticides, "Denmark Restricts Water-Contaminating Herbicide," [http://www.beyondpesticides.org/news/daily\\_news\\_archive/2003/9\\_23\\_03.htm](http://www.beyondpesticides.org/news/daily_news_archive/2003/9_23_03.htm) (Accessed January 8, 2009).
5. Richard, S.; Moslemi, S.; Sipahutar, H.; Benachour, N.; and Seralini, G-E "Differential effects of glyphosate and Roundup on human placental cells and aromatase"; Environmental Health Perspectives, 2005, 113(6) 716-720. doi:10.1289/ehp.7728
6. United States Environmental Protection Agency, "Consumer Factsheet on Glyphosate," [http://www.epa.gov/OGWDW/contaminants/dw\\_contamfs/glyphosa.html](http://www.epa.gov/OGWDW/contaminants/dw_contamfs/glyphosa.html) (Accessed January 5, 2008).
7. United States Environmental Protection Agency, "Method 547: Determination of glyphosate in drinking water by direct-aqueous-injection HPLC, post-column derivatization, and fluorescence detection," [http://www.accustandard.com/asi/pdfs/epa\\_methods/547.pdf](http://www.accustandard.com/asi/pdfs/epa_methods/547.pdf) (Accessed January 5, 2008).

In addition to these offices, Thermo Fisher Scientific maintains a network of representative organizations throughout the world.

**Africa-Other**  
+27 11 570 1840

**Australia**  
+61 2 8844 9500

**Austria**  
+43 1 333 50 34 0

**Belgium**  
+32 53 73 42 41

**Canada**  
+1 800 530 8447

**China**  
+86 10 8419 3588

**Denmark**  
+45 70 23 62 60

**Europe-Other**  
+43 1 333 50 34 0

**Finland/Norway/  
Sweden**  
+46 8 556 468 00

**France**  
+33 1 60 92 48 00

**Germany**  
+49 6103 408 1014

**India**  
+91 22 6742 9434

**Italy**  
+39 02 950 591

**Japan**  
+81 45 453 9100

**Latin America**  
+1 608 276 5659

**Middle East**  
+43 1 333 50 34 0

**Netherlands**  
+31 76 579 55 55

**South Africa**  
+27 11 570 1840

**Spain**  
+34 914 845 965

**Switzerland**  
+41 61 716 77 00

**UK**  
+44 1442 233555

**USA**  
+1 800 532 4752

[www.thermoscientific.com](http://www.thermoscientific.com)

AN63068\_E 08/16S

## Legal Notices

©2016 Thermo Fisher Scientific Inc. All rights reserved. IonPac and ASRS are registered trademarks of Dionex Corporation. All other trademarks are the property of Thermo Fisher Scientific Inc. and its subsidiaries. This information is presented as an example of the capabilities of Thermo Fisher Scientific Inc. products. It is not intended to encourage use of these products in any manners that might infringe the intellectual property rights of others. Specifications, terms and pricing are subject to change. Not all products are available in all countries. Please consult your local sales representative for details.







# Surface, Drinking and Waste Water Analysis

Pharmaceuticals and Personal  
Care Products

**Thermo**



# Quantitative and Semi-Quantitative Determination of PPCPs and Their By-products in Wastewater Treatment Plants Samples Using UHPLC-Orbitrap MS and Data Mining Technologies

*Jonathan Beck,<sup>1</sup> Tung-Vi Nguyen,<sup>2</sup> Ramin Farnood,<sup>2</sup> Charles Yang,<sup>1</sup> Paul Yang,<sup>3</sup> Maciej Bromirski,<sup>1</sup> Sonya Kleywegt,<sup>3</sup> Shahram Tabe<sup>3</sup> and Dipankar Ghosh<sup>1</sup>*

*<sup>1</sup>Thermo Fisher Scientific, San Jose, CA, USA; <sup>2</sup>Department of Chemical Engineering & Applied Chemistry, University of Toronto, Toronto, Ontario, Canada; <sup>3</sup>Ontario Ministry of the Environment, Etobicoke, Ontario, Canada*

## Overview

**Purpose:** Develop an analytical method to (1) determine PPCP concentrations in wastewater samples, and (2) examine the transformation of selected PPCPs during treatment processes.

**Methods:** Samples prepared by solid phase extraction (SPE) and analyzed by high performance liquid chromatography-Orbitrap mass spectrometry (HPLC-Orbitrap MS).

**Results:** Quantitative results of selected pharmaceuticals and personal care products (PPCPs) like DEET, Triclosan (TCS), Triclocarban (TCC), Diclofenac (DCL), Carbamazepine (CBZ) and semi-quantitative of their degradation products were obtained.

## Introduction

Results obtained from a simple and powerful workflow that can readily determine PPCPs and their by-products in wastewater treatment plant (WWTPs) samples will be presented. This workflow was applied in a survey of 43 permeate samples obtained from a pilot anaerobic membrane bioreactor (AnMBR). Quantitative results show the prevalence of various PPCPs in wastewater, particularly for compounds with high usage and/or poor elimination (e.g., caffeine, carbamazepine (CBZ), DEET, lidocaine, lincomycin, ketoprofen, and bezafibrate). For PPCP by-products, we identified that in-situ microbial degradation was the dominant pathway for triclocarban (TCC) removal; whilst triclosan (TCS), diclofenac (DCF) and CBZ were eliminated via a combination of photodegradation and metabolism. Thirty by-products were detected in this pilot survey, including the toxic compounds chlorophenol and acridone.

## Methods

### Sample Preparation

For this study, permeate samples were chosen due to their complex matrix which poses as a challenge for conventional analytical method. These samples were collected from a pilot anaerobic membrane bioreactor (AnMBR) pilot plant located at the Wastewater Technology Centre (Environment Canada, Burlington, Ontario). A total of 35 permeate samples permeate tank from January 2012 to March 2013. During this time, the reactor were operated at different temperatures at 20, 35 and 55 °C using samples collected, respectively, in summer, winter and winter, to investigate the effect on the removal of PPCPs in permeates. Grab samples were contained in 1L-amber bottles without headspace and stored in dark, cold storage (4°C) until analysis.

Neat standards of native target compounds were purchased from Sigma-Aldrich (Oakville, ON, Canada). Deuterium (D) and <sup>13</sup>C-labelled standards were purchased from CDN Isotopes (Pointe-Claire, QC, Canada) and Cambridge isotope Laboratories (Andover, MA, US). Five levels of analytical standard solutions were prepared by diluting intermediate solutions with CH<sub>3</sub>OH HPLC grade acetonitrile (CH<sub>3</sub>CN) and methanol (CH<sub>3</sub>OH) were purchased from Thermo Fisher Scientific (Ottawa, ON, Canada). High purity water used for aqueous mobile phases and sample preparation was produced by passing reverse osmosis water through a Thermo Scientific™ Barnstead™ Nanopure™ water purification system (Mississauga, ON, Canada). Laboratory Services NBranch (LaSB) method E3454<sup>1</sup> was used to prepare samples for targeted compound analysis and non-targeted compound screening. Waters OASIS® (Mississauga, ON, Canada) HLB solid phase extraction (SPE) cartridge (6 cc, 500 mg) was used in the extraction. Method E3454 has been accredited by the Canadian Association for Laboratory Accreditation (CALA) since 2004.

### Liquid Chromatography (or more generically Separations)

Sample analysis was achieved on a Thermo Scientific™ Dionex™ UltiMate™ 3000 HPLC consisting of a HRG-3400RS binary pump, WPS-3000 autosampler, and a TCC-3400 column compartment. Separation was made by injecting 5 µL extracts into a Thermo Scientific™ Betasil™ and a Thermo Scientific™ Hypersil™ Gold, 2.1x100 mm columns, respectively, for positive and negative mode Orbitrap MS analysis.

One positive mode HPLC and two negative mode HPLC separations were used for the analysis of PPCPs and their by-products.

**TABLE 1. HPLC mobile phase and gradient used in the analysis**

Column oven temperature: 35°C; Flow rate: 450 mL/min				
Mobile phase (Positive)	A: 5 mM HCOONH <sub>4</sub> /0.1% HCOOH in 10:90/CH <sub>3</sub> OH:H <sub>2</sub> O B: 90:10/CH <sub>3</sub> OH:H <sub>2</sub> O			
Mobile phase (Negative I)	A: 10:90/CH <sub>3</sub> CN:H <sub>2</sub> O, pH 6.95±0.3 B: CH <sub>3</sub> CN			
Mobile phase (Negative II)	A: 5 mM CH <sub>3</sub> COONH <sub>4</sub> in 10:90/CH <sub>3</sub> CN:H <sub>2</sub> O, pH 6.95±0.3 B: CH <sub>3</sub> CN			
HPLC Gradient	Time (min)	% A	% B	Curve
	0.0	95	5	5
	2.0	25	75	5
	10.0	5	95	7
	15.0	5	95	5
	15.2	95	5	5

### Mass Spectrometry

The HPLC was interfaced to a Thermo Scientific™ Exactive Plus™ Orbitrap MS using a heated electrospray ionization (HESI) interface. The Orbitrap MS system was tuned and calibrated in positive and negative modes by infusion of standard mixtures of MSCAL5 and MSCAL6. High purity nitrogen (>99%) was used in the ESI source (35 L/min). Spray voltages used were 2500 and 3200 V for positive and negative modes. Mass spectrometric data was acquired at a resolving power of 140000 (defined as full-width-at-half-maximum peakwidth at  $m/z$  200,  $R_{FWHM}$ ), resulting a scanning rate of > 1.5 scans/sec when using automatic gain control target of  $1.0 \times 10^6$  and a C-trap inject time of 100 msec.

### Data Analysis

Thermo Scientific™ TraceFinder™ software were used to perform quantitative analysis for 56 PPCPs. The same software was also used to perform non-targeted screening along with a database of 312 compounds consisting of pharmaceutically active compounds and their metabolites, steroids, hormones, surfactants and perfluorohydrocarbons. TraceFinder software is used to search for adduct ions (M+H)<sup>+</sup>, (M+NH<sub>4</sub>)<sup>+</sup> and (M+Na)<sup>+</sup> in the positive mode and (M-H)<sup>-</sup> molecular ion in the negative mode for compounds listed in the database. The software then creates an extracted ion chromatogram (XIC) using a mass extraction window (MEW) of 5 ppm. Analytes were automatically identified using an XIC area threshold of 50,000 (approximately 25–50 pg/mL (ppt) depending on compound), a 5 ppm mass accuracy for the mono-isotopic mass (M) and at least two isotopic peaks ((M+1) and (M+2)), and a relative intensity of 90% ± 10% from the theoretical values. Typical screening time was about 65 sec/sample using the 312 CEC database. Results obtained from TraceFinder software were also exported to Thermo Scientific™ SIEVE™ software to carry out ChemSpider™ search. Principal component analysis was carried out using the SIEVE software too.

## Results

### Quantitative Analytical Results

Quantitative analysis determined 43 target PPCPs comprised of pharmaceuticals like antibiotics, non-steroidal anti-inflammatory drug (NSAID); as well as personal care products such as insect repellent and antimicrobial agents (Table 2). Antibiotics (e.g. ciprofloxacin and sulfa drugs) found have the lowest median concentration compared to other therapeutic classes. As depicted in Figure 1, the highest median concentration is reported for the antidepressant drug; however since this group only has one representative (i.e., CBZ), it is difficult to draw any conclusion.

**TABLE 2. Quantitative results for PPCPS with > 75% occurrence in the 35 samples analyzed**

Compound Name	Usage	CAS #	Occur.	Concentration (ng/L)		
				Min	Max	Median
Caffeine	Stimulant	58-08-2	100%	2.95E+02	2.52E+04	5.45E+03
Carbamazepine	Antiepileptic/antidepressant	298-46-4	100%	6.96E+02	1.12E+04	2.52E+03
DEET	insect repellent	134-62-3	100%	2.19E+02	1.81E+03	6.52E+02
Lidocaine	anesthetic/anti-arrhythmic	137-58-6	100%	1.75E+02	3.41E+03	6.48E+02
Lincomycin	Antibiotic	154-21-2	100%	5.18E+01	9.29E+03	6.36E+02
Ketoprofen	analgesic/anti-inflammatory	22071-15-4	100%	4.56E+01	3.51E+02	1.27E+02
Bezafibrate	lipid regulator	41859-67-0	100%	3.41E+01	3.24E+02	7.16E+01
Sulfamethazine	Antibiotic	57-68-1	97%	1.16E+01	1.14E+02	3.12E+01
Bisphenol A	commercial additive	80-05-7	95%	1.60E+03	2.80E+06	9.42E+03
Acetaminophen	analgesic/anti-inflammatory	103-90-2	95%	3.52E+02	7.86E+05	8.03E+03
Diclofenac	analgesic/anti-inflammatory	15307-86-5	95%	2.70E+00	2.08E+04	1.27E+03
Norfloxacin	antibiotic	70458-96-7	95%	1.91E+02	1.03E+03	4.33E+02
Triclocarban	antimicrobial/antifungal	101-20-2	95%	1.04E+01	1.27E+03	2.97E+02
Triclosan	antibacterial/antifungal	3380-34-5	87%	2.07E+02	1.26E+05	3.30E+03
Estrone	estrogen	53-16-7	85%	5.10E+00	1.64E+03	2.65E+02
Oxolinic acid	antibiotic	14698-29-4	85%	7.89E+01	6.42E+03	1.62E+02
Oxybenzone	sunscreen	131-57-7	82%	1.80E+00	1.43E+04	2.95E+02
Norethindrone	ovulation inhibitor	68-22-4	82%	4.64E+01	1.46E+03	2.75E+02
Ciprofloxacin	antibiotic	85721-33-1	79%	9.34E+02	5.76E+04	4.00E+03
Estriol	estrogen	50-27-1	79%	2.69E+01	2.31E+04	6.57E+02
Ibuprofen	analgesic/anti-inflammatory	15687-27-1	77%	1.49E+01	1.25E+05	4.37E+03

**FIGURE 1. Median concentrations for selected groups of PPCPs**

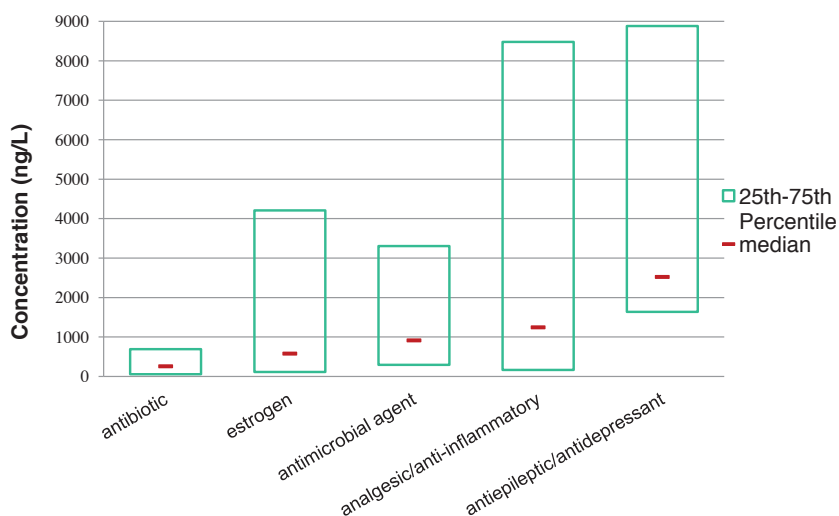

### Semi-Quantitative Determination of PPCPs

In this presentation, TCS (antimicrobial agent) and CBZ (anticonvulsant drug) will be used for the demonstration of by-product formation during wastewater treatment processes. They are representative of pharmaceuticals and are the two most studied groups of medicines. The effect of treatment temperatures and seasonal changes were first investigated using principal component analysis. As shown in Figure 2, scores for samples treated at 20°C (red, summer) and 55°C (brown, winter) were similar; while scores for samples obtained from 35°C (green, winter) and standards (blue) were quite different. An indication that treatment temperatures exerted more effect on samples than seasonal changes.

**FIGURE 2. Overall effect of treatment temperatures**

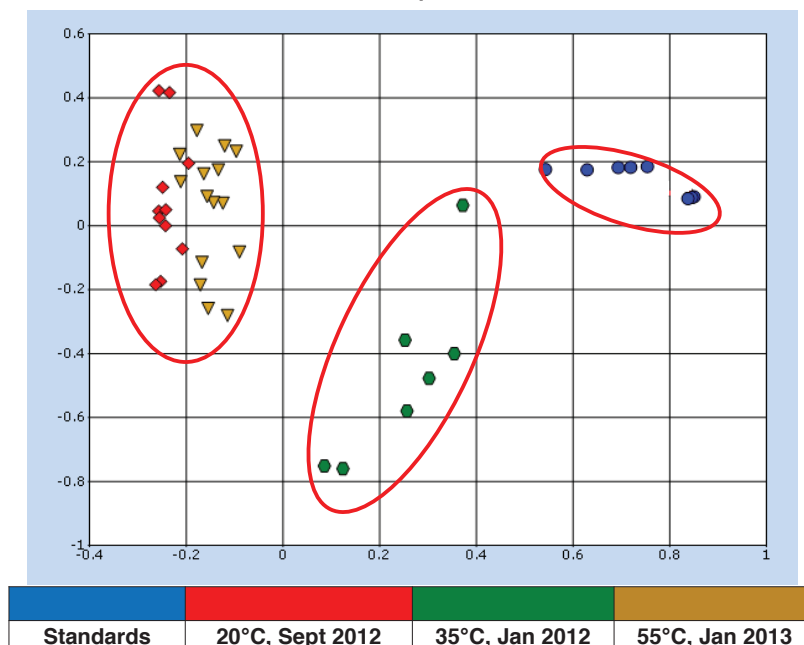

Despite the vast number of TCS by-products proposed in the literature <sup>2</sup>, five compounds (i.e., dichlorohydroxy-diphenyl ether, 2- and 4-chlorophenol (Cl-Ph), methyl Triclosan (Me-TCS), and 4- and 5-chloro Triclosan, (Cl-TCS)). Semi-quantitative concentrations of TCS, deuterium labelled TCS (TCS-D3), Cl-Ph, Cl-TCS and Me-TCS are shown in Figure 3, indicating population of Cl-Ph were minimum while other compounds reached their maximum at 35°C.

**Figure 3. Relative concentration of TCS and the three TCS by-products found**

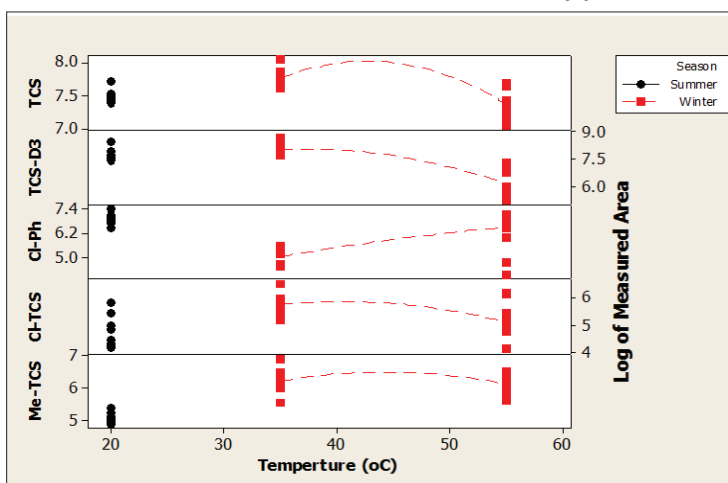

In comparison with other PPCPs studied, CBZ had the most by-products identified (16) in this work. The unequivocal identification for CBZ by-products thus became a challenge as many of these compounds had the same chemical formula and therefore, the same monoisotopic mass measured by the Orbitrap MS. Without available reference standards, the chromatographic peak was assigned to the most probable structure with the most dominated population in the literature. Semi-quantitative concentrations of CBZ, deuterium labelled CBZ (CBZ-D10), and the three by-products found are shown in Figure 4.

**Figure 4. Relative concentration of CBZ and the three CBZ by-products found**

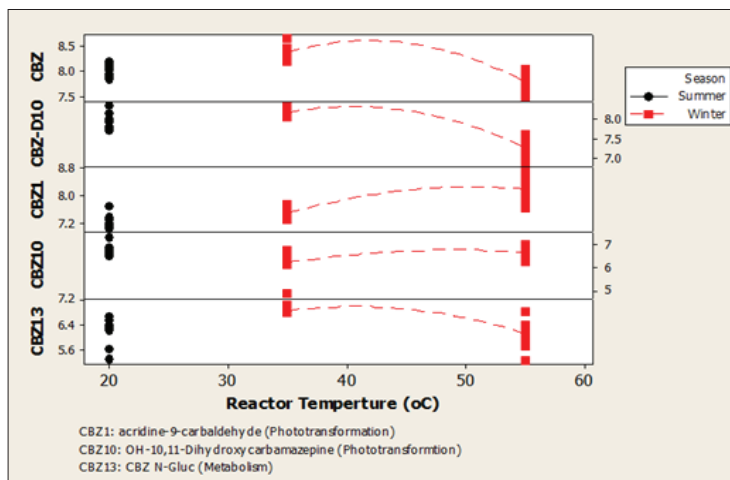

## Conclusion

- Quantitative results of PPCPs were obtained using HPLC-Orbitrap MS.
- Semi-quantitative results, seasonal trends and effect of treatment temperature on PPCP by-products were obtained using TraceFinder and SIEVE software.
- Efforts to obtain analytical standards to complete the studies are on-going.

## References

1. "The Determination of Emerging Organic Pollutants in Environmental Matrices by Liquid Chromatography-Tandem Mass Spectrometry (LC-MS/MS)", Ontario Ministry of the Environment method E3454. Available via [laboratoryservicesbranch@ontario.ca](mailto:laboratoryservicesbranch@ontario.ca).
2. "Monitoring the photochemical degradation of triclosan in wastewater by UV light and sunlight using solid-phase microextraction". Sanchez-Prado, L., Llompart, M., Lores, M., Garcia-Jares, C., Bayona, J. M., & Cela, R. (2006). *Chemosphere*, 65(8), pp. 1338-1347.

## Acknowledgements

We would like to thank Dr. Vince Pileggi for providing permeate samples; as well as Ms. Renee Luniewski for providing valuable suggestions to make this work complete.

[www.thermofisher.com](http://www.thermofisher.com)

©2016 Thermo Fisher Scientific Inc. All rights reserved. Microsoft® and Excel® are trademarks of Microsoft Corporation. OASIS® is trademarks of Waters Corporation. All other trade-marks are the property of Thermo Fisher Scientific and its subsidiaries. This information is presented as an example of the capabilities of Thermo Fisher Scientific products. It is not intended to encourage use of these products in any manners that might infringe the intellectual property rights of others. Specifications, terms and pricing are subject to change. Not all products are available in all countries. Please consult your local sales representative for details.

**Africa** +43 1 333 50 34 0  
**Australia** +61 3 9757 4300  
**Austria** +43 810 282 206  
**Belgium** +32 53 73 42 41  
**Canada** +1 800 530 8447  
**China** 800 810 5118 (free call domestic)  
400 650 5118

**Denmark** +45 70 23 62 60  
**Europe-Other** +43 1 333 50 34 0  
**Finland** +358 9 3291 0200  
**France** +33 1 60 92 48 00  
**Germany** +49 6103 408 1014  
**India** +91 22 6742 9494  
**Italy** +39 02 950 591

**Japan** +81 45 453 9100  
**Latin America** +1 561 688 8700  
**Middle East** +43 1 333 50 34 0  
**Netherlands** +31 76 579 55 55  
**New Zealand** +64 9 980 6700  
**Norway** +46 8 556 468 00  
**Russia/CIS** +43 1 333 50 34 0

**Singapore** +65 6289 1190  
**Spain** +34 914 845 965  
**Sweden** +46 8 556 468 00  
**Switzerland** +41 61 716 77 00  
**UK** +44 1442 233555  
**USA** +1 800 532 4752

**Thermo**  
S C I E N T I F I C

A Thermo Fisher Scientific Brand





# A Novel Screening Method for Anthropogenic Sewage Pollutants in Waste Water, Ground Water and Drinking Water Samples by LC-HRAM Analysis

*Sebastian Westrup, Nick Duczak, and Michal Godula  
Thermo Fisher Scientific, San Jose, CA*



## Overview

For the present study, the Thermo Scientific™ Q Exactive™ mass spectrometer was coupled with an Thermo Scientific Accela™ Open Autosampler to do fully automated high-volume injection and sample enrichment of up to 5 mL sample volumes. Samples from waste water to drinking water were investigated for anthropogenic compounds in the water cycle down to low ppt concentration levels without time consuming solid phase extraction for screening of all kinds of water matrices.

## Introduction

In the last decade, there has been growing public concern about potential contamination of water and the environment with anthropogenic compounds and their degradation products and possible negative impacts on nature and public health. As a response, there is an increased interest in more efficient screening techniques for larger numbers of possible pollutants compared to those traditionally carried out by triple quadrupole mass spectrometers. Full scan MS with high-resolution and accurate-mass does not require optimization of compound-specific parameters and has the ability to properly separate matrix interferences from compounds of interest. A combination of software suites covering the workflow make it possible to acquire and process data on the fly. Data mining in several fields of investigation side by side can help get the full picture about contaminants.

## Methods

### Sample Preparation

Water samples of each location were filtered through 0.25 micrometer PTFE syringe filters prior to analysis.

### Liquid Chromatography (or more generically Separations)

Chromatographic analysis was performed using the Thermo Scientific Accela Open U-HPLC system.

Chromatographic conditions were as follows:

Column: Thermo Scientific™ Hypersil™ GOLD aQ C18 column, 100 x 2.1 mm, 3.0 μm particle size.

Mobile Phases: A (Water), B (Methanol) ; both buffered with 5 mM ammonium formate + 0.05 % formic acid. Sample Injection Volume: 0.25 – 5 mL; Column Temp.: 25 °C

### Gradient

Pump General		Gradient Program				
Pump 1						
	Time	A%	B%	C%	D%	μ/min
0	0.00	100.0	0.0	0.0	0.0	500.0
1	10.00	100.0	0.0	0.0	0.0	500.0
2	11.00	80.0	20.0	0.0	0.0	500.0
3	18.00	0.0	100.0	0.0	0.0	500.0
4	25.00	0.0	100.0	0.0	0.0	500.0
5	25.10	100.0	0.0	0.0	0.0	500.0
6	30.00	100.0	0.0	0.0	0.0	500.0
7		100.0	0.0	0.0	0.0	500.0



### Mass Spectrometry and Source Conditions

HR/MS Scan Range: 120 to 1200 ( $m/z$ )  
Polarity switching: off  
Resolution: 70k (Full scan), 35k (ddMS2)  
HDC Fragmentation: Collision Energy 35 eV  
Heated Electrospray Ion Source  
Spray Voltage (pos/neg): 4800 V / 3800 V  
Capillary Temp 300 °C  
Sheath Gas: 60, Aux Gas: 15 (Ion Sweep Gas: 1)  
Vaporizer Temperature: 350 °C

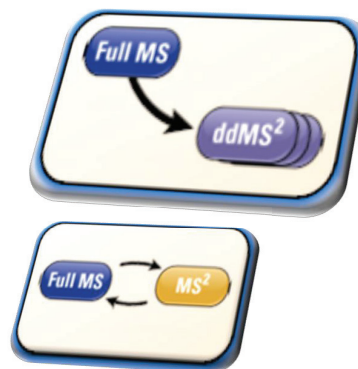

## Data Processing Tools

Thermo Scientific™ ExactFinder™ software was used for fully automated data processing of generated Full Scan MS + ddMS2 experiments for targeted screening approaches with a simple four-click procedure. Additional features like Isotopic Pattern Match, customized compound data stores and spectral libraries have been applied to find compounds of interest. High-resolution, accurate-mass data files are open to retrospective data analysis also by other software such as Thermo Scientific™ SIEVE™, Thermo Scientific™ MetWorks™, Thermo Scientific™ Mass Frontier™ softwares as well as a ChemSpider™ (ChemZoo Inc, Wake Forest North Carolina) search based on elemental composition proposals from present accurate-mass signals. With these software tools, it was possible to drive investigation in different directions simultaneously with a single injection of a sample set. Therefore, it is recommended to have a second data set ready. This can be generated by using a combination Full Scan MS + All Ion Fragmentation MS2 experiment to have full information for possible fragments as well.

## Results

### Mapping the Water Cycle in SIEVE Software

The sampling area comprised several locations within a few square miles around a waste water plant (WWTP): Water works, drinking water drainage area, WWTP with its catchment area, and a receiving water course in an area where hospitals are located. To show the impact of a WWTP to downstream waterways including waterworks, SIEVE software has been used to monitor 70 compounds of interest, which are known pollutants to drinking water sources like Carbamazepine, Phenazone, Simazine, and Tramadol. These are known to be persistent in the environment and could be used as tracer substances.

FIGURE 1. Sample Characteristics Comparison

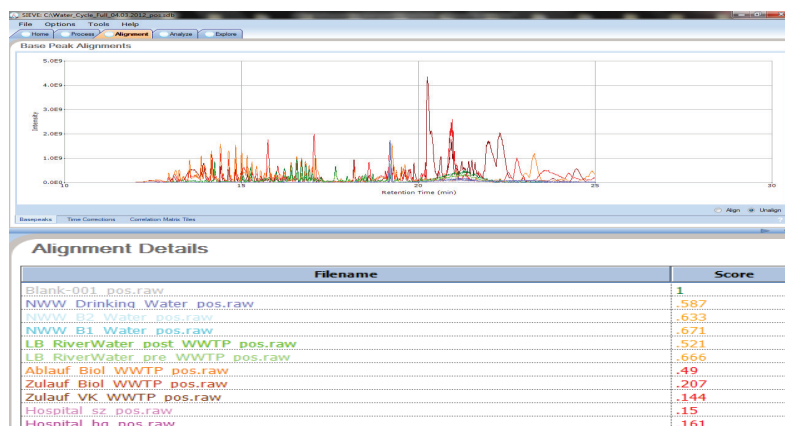

By applying differential analysis to samples from the different locations (Figure 1) we get first information about the sample's characteristics when we set the blank as a reference. In terms of having similar score levels the locations are well aligned. Trend comparison of the compounds of interest within the different locations has been generated and a visual display of the samples is shown as overlapped chromatograms. SIEVE performs background subtraction and framing before identification of the compounds in the different samples.

Figure 2 shows the heavy pollution impact of the waste water treatment plant effluent to its receiving water course. Carbamazepine passed through the WWTP into the receiving water course towards the water works. In Figure 3, the performance of SIEVE and its automatic background subtraction is shown in detail. This feature is helpful in terms of showing the impact of the WWTP effluent to its receiving water course by having instrument background noise eliminated as well.

FIGURE 2. Location Survey of Carbamazepine

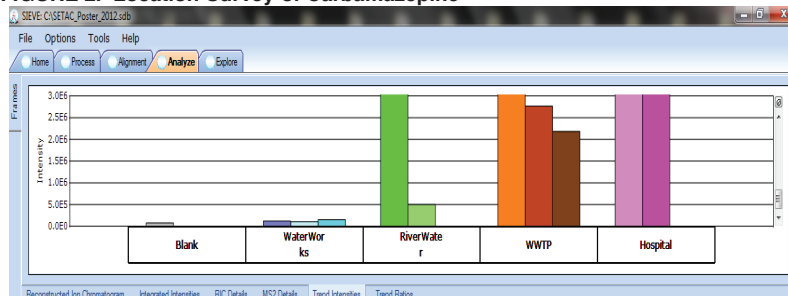
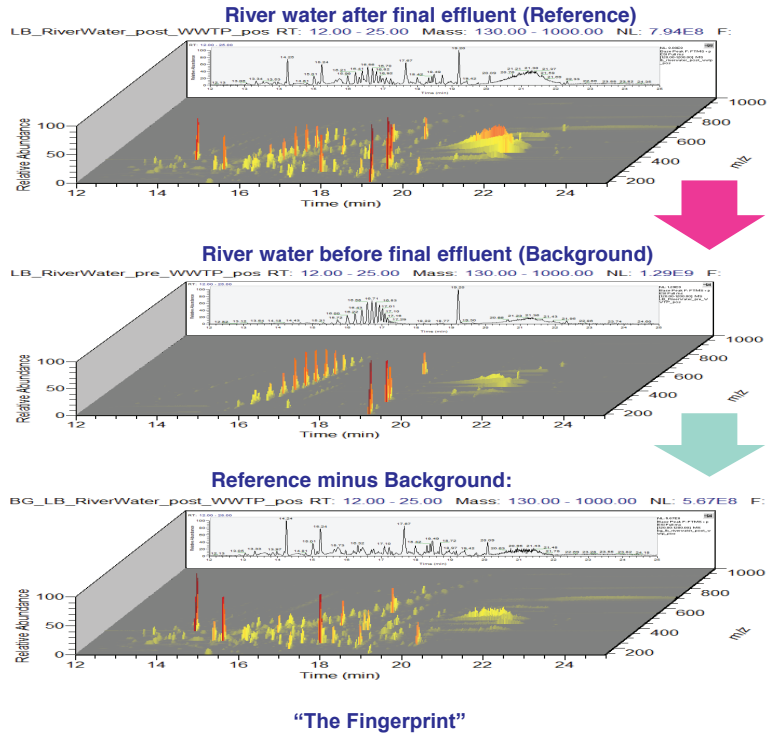

FIGURE 3. Data processing receiving water sample (background subtraction)



**Identify, Confirm & Quantitate in ExactFinder Software**

ExactFinder software was used to extract from the raw data information for both confirmation and quantitation in a single processing step. The processing method has set retention time and exact mass and isotopic pattern as identification criteria and spectral library matching using ddMS2 spectra as confirmation criteria. An example of the method setup is shown in Figure 4.

FIGURE 4. ExactFinder Method Setup

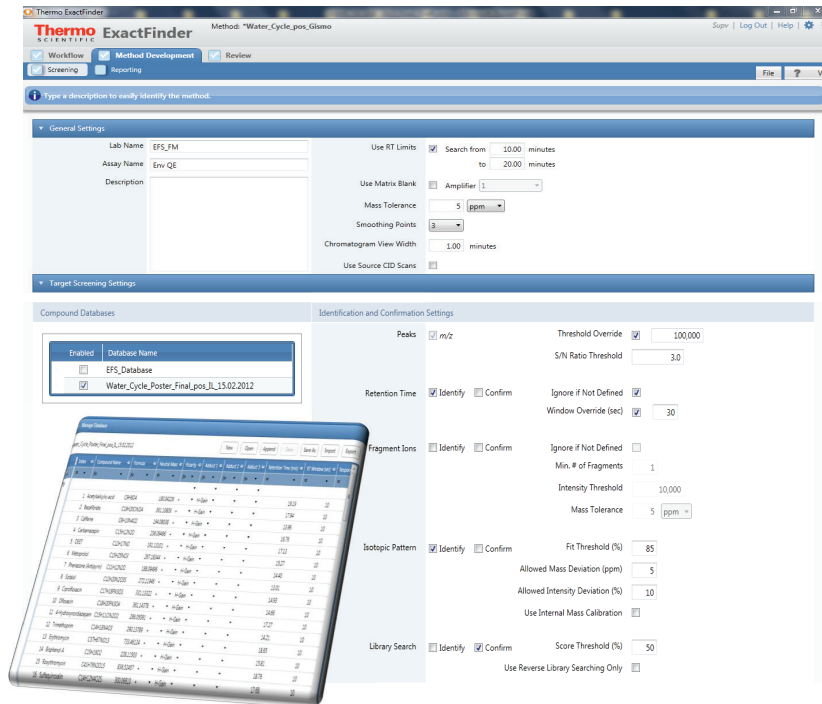

In Figure 5, the extracted information for identification of Carbamazepine is shown as an XIC (5 ppm). Isotopic pattern match in the new visualization mode was used as an identification criteria in addition to accurate mass and retention time checked against standard samples.

FIGURE 5. Targeted Screening & Isotopic Pattern Match with ExactFinder

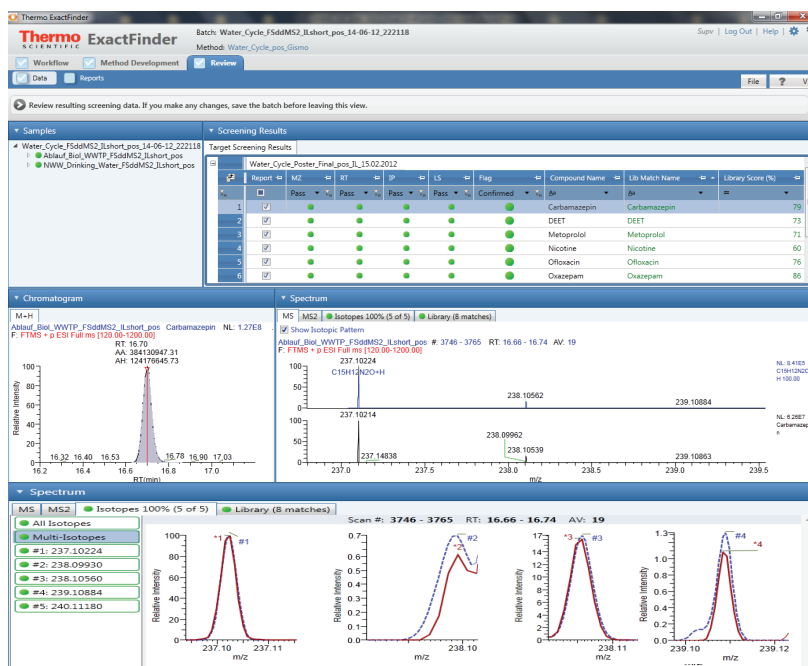

The quantitation table in Figure 6 gives an overview about present concentration levels of Carbamazepine within the investigated water cycle from the hospital, WWTP, downstream water ways and drinking water facilities. In drinking water samples concentrations of 54 and 59 ppt has been calculated based on Full Scan MS experiment data. The calibration curve shows linear regression from 10 to 1000 ppt.

Figure 7 shows the confirmation of Carbamazepine by comparison to the Spectral Library.

FIGURE 6. Quantitation of Carbamazepine from the Full Scan MS experiment

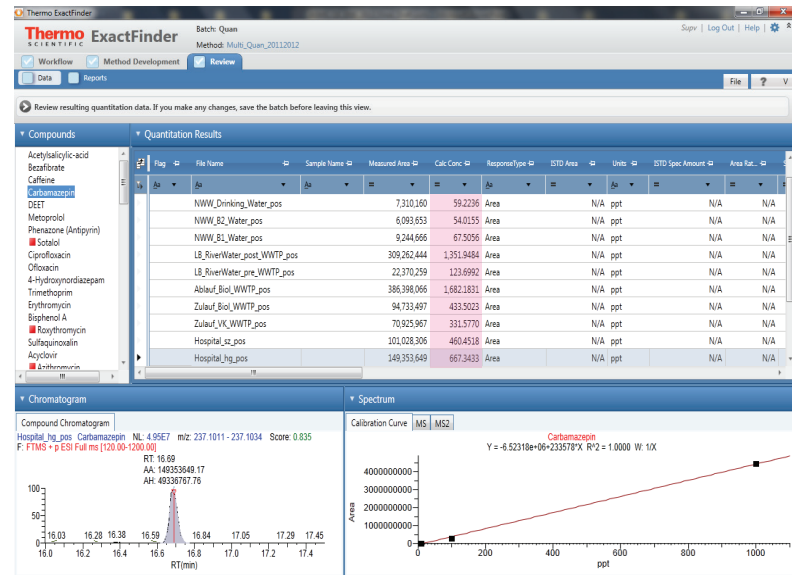
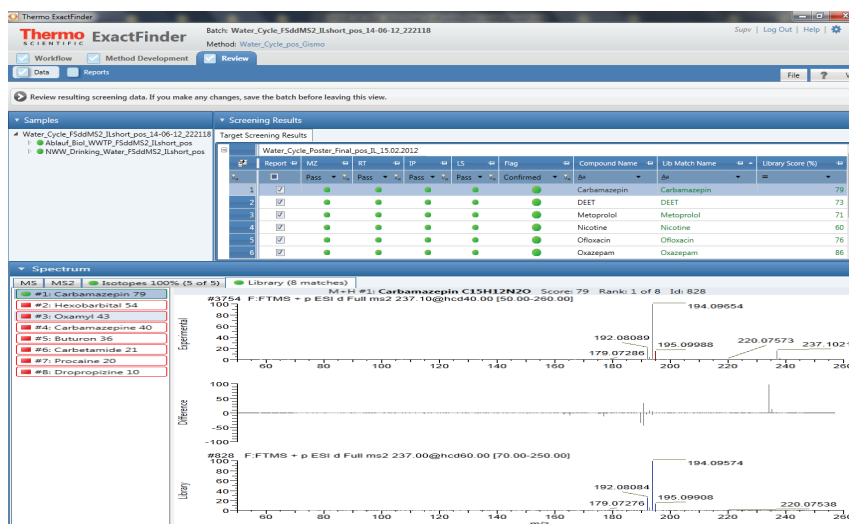
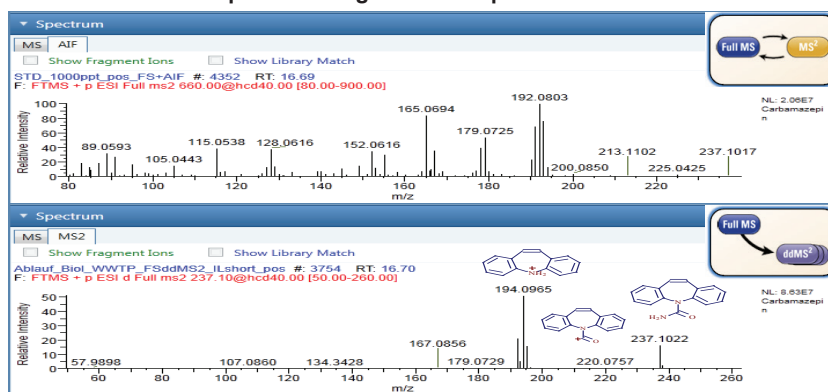

FIGURE 7. Spectral Library Confirmation with ExactFinder



In Figure 8, the ddMS2 spectra is shown compared to an All Ion Fragmentation MS2 spectra. Both scans were generated from the same sample vial. Where the quadrupole filters the precursor ion before fragmentation, it delivers cleaner spectra for specific confirmation against spectral libraries. Suspected or targeted screening tasks can be applied based on this.

FIGURE 8. Cleaner Spectra through ddMS2 experiments on Q Exactive MS



## Conclusion

The presented data was based on Q Exactive Full Scan MS in combination with ddMS2 experiments for targeted screening purposes only. For unknown screening tasks it is recommended to generate Full Scan MS + All Ion Fragmentation MS2 data. This gives access to fragment information over the full chromatographic time scale. Because, ddMS2 experiments are strictly based on preset RT windows and precursor masses which have to be investigated and uploaded to inclusion list in advance. Q Exactive inclusion list files can be generated from a compound data base file by a single mouse click.

ExactFinder software coupled with the Q Exactive provided easy access to full quantitative, confirmation and screening data in one package including retrospective data analysis. New features like isotopic pattern multi view and improved spectral library comparison algorithm supports quicker investigation and extraction of information of interest.

By using SIEVE, we could generate location surveys for further monitoring investigation and mass balance calculations in ExactFinder. Exported data is fully compatible.

## Acknowledgements

The authors wish to thank to AHW Waste Water Treatment Plant, Heidelberg, Germany, for providing samples for this study.



[www.thermofisher.com](http://www.thermofisher.com)

©2016 Thermo Fisher Scientific Inc. All rights reserved. ChemSpider is a registered US trademark of ChemZoo Inc., Wake Forest North Carolina, and is a Service currently provided by the Royal Society of Chemistry. CTC is a trademark of CTC Analytics, Zwingen, Switzerland. All other trademarks are the property of Thermo Fisher Scientific, Inc. and its subsidiaries. Specifications, terms and pricing are subject to change. Not all products are available in all countries. Please consult your local sales representative for details.

**Africa-Other** +27 11 570 1840  
**Australia** +61 3 9757 4300  
**Austria** +43 1 333 50 34 0  
**Belgium** +32 53 73 42 41  
**Canada** +1 800 530 8447  
**China** +86 10 8419 3588  
**Denmark** +45 70 23 62 60

**Europe-Other** +43 1 333 50 34 0  
**Finland/Norway/Sweden**  
+46 8 556 468 00  
**France** +33 1 60 92 48 00  
**Germany** +49 6103 408 1014  
**India** +91 22 6742 9434  
**Italy** +39 02 950 591

**Japan** +81 45 453 9100  
**Latin America** +1 561 688 8700  
**Middle East** +43 1 333 50 34 0  
**Netherlands** +31 76 579 55 55  
**New Zealand** +64 9 980 6700  
**Russia/CIS** +43 1 333 50 34 0  
**South Africa** +27 11 570 1840

**Spain** +34 914 845 965  
**Switzerland** +41 61 716 77 00  
**UK** +44 1442 233555  
**USA** +1 800 532 4752

**Thermo**  
SCIENTIFIC  
Part of Thermo Fisher Scientific



# High Resolution LC-MS for Screening and Quantitative Analysis of Antibiotics in Drinking Water Using an Orbitrap and Online Sample Preparation

*Jonathan Beck, Charles Yang, Dipankar Ghosh, and Kristi Akervik*

*Thermo Fisher Scientific, San Jose, CA, USA*



## Overview

**Purpose:** To demonstrate online sample pre-concentration and extraction of water samples and analysis with high-resolution, accurate mass (HR/AM) detection, quantitation and confirmation.

**Methods:** Inject 1 mL water samples directly onto a trapping column. The trapped compounds are then backflushed onto an analytical HPLC column and detected using a Thermo Scientific Orbitrap mass analyzer.

**Results:** This poster describes a method to perform screening and quantitation of antibiotics at ppt and sub-ppt levels in drinking water using online pre-concentration together with HR/AM confirmations of the compounds.

## Introduction

Most current methodologies for the quantitation of antibiotics in drinking water revolve around analysis using triple stage quadrupole platforms with offline sample preparation. While this is a proven technique for the analysis of many contaminants in drinking water, ground water and other environmental water samples, the offline sample preparation steps are time-consuming and prone to operator error and reproducibility problems. In addition, the need to transport large sample volumes from the collection site to the laboratory, typically 1 L samples, is laborious. This poster illustrates the ability to directly inject the water sample without any offline pre-concentration steps, while achieving the same sensitivities required for the experiment. Thus smaller sampling volumes can be used.

The method described here utilizes liquid chromatography-mass spectrometry (LC-MS) with a Thermo Scientific Exactive Plus Orbitrap™ mass spectrometer using HR/AM. While the triple stage quadrupole instrument is routinely used in these types of experiments, we demonstrate the ability to use a benchtop HR/AM instrument to quantitate and confirm the contaminants of interest. The advantages of HR/AM instruments includes high resolution to isolate contaminants of interest from interfering matrix peaks at similar masses as well as the ability to re-interrogate data at a later date for additional compounds. Furthermore, compared to the triple stage quadrupole instrument, method development time is greatly reduced as there is no need to individually optimize each analyte of interest.

## Methods

### Sample Preparation

Samples were prepared from a stock solution of antibiotics in methanol. Calibration solutions were prepared from the stock solutions, resulting in 8 levels of antibiotics for positive analysis. Dilutions were made in laboratory water (HPLC-grade) to create eight different calibration levels. The antibiotic calibration samples were acidified with formic acid to a concentration of 0.1% formic acid. The concentration range varied for each compound, but were in the approximate range of 1 ppt to 10 ppb. This ensured compatibility with the mobile phase for chromatography. No further sample preparation was conducted. The antibiotics studied for this poster were: carbamazepine, erythromycin, ketoprofen, norethindrone, roxithromycin, sulfachloropyridazine, sulfadimethoxine, sulfamerazine, sulfamethazine, sulfamethizole, sulfamethoxazole, sulfathiazole, trimethoprim and tylosin.

### Liquid Chromatography

Liquid chromatography was performed using the Thermo Scientific EQUAN MAX system. The EQUAN MAX system consists of two high pressure liquid chromatography (HPLC) pumps, autosampler and switching valves. The first HPLC pump, a Thermo Scientific Accela 600 pump, is used to transfer the large volume sample from the autosampler loop to the loading column (Thermo Scientific Hypersil GOLD aQ column, 20 x 2.1 mm, 12 $\mu$ ) at a flow rate of 1.0 mL/min. After 1.2 minutes, a six-port valve is switched to back-flush the loading column onto the analytical column (Thermo Scientific Accucore aQ column, 100 x 2.1 mm, 2.6 $\mu$ ), and remains inline for 11 minutes. The analytes are eluted using an 11-minute reversed-phase gradient from the second HPLC pump, the Thermo Scientific Accela 1250 pump. The mobile phases were water (A) and methanol (B), both containing 0.1% formic acid and 4mM ammonium formate. The gradient program for both pumps is shown in Table 1. After 12 minutes of runtime, the loading column is returned to its original position, taking the analytical column offline from the loading column, and the system is re-equilibrated for the next injection. The total run time is 15 minutes. The flow diagram for the EQUAN MAX system is shown in Figure 1.

## Mass Spectrometry

The Exactive™ Plus Orbitrap mass spectrometer was used in this experiment. The Exactive Plus was operated in alternating full scan and all ion fragmentation (AIF) mode with positive electrospray ionization. One scan of full scan MS data was collected, and subsequently, all of the ions entering the MS were fragmented in the higher-energy C-trap dissociation (HCD) collision cell at a collision energy (CE) of 30 eV with a 20% stepped CE, and analyzed in the Orbitrap mass analyzer. The resolution for the full scan experiment was 70,000 and the resolution of the AIF experiment was 35,000. The mass range 150-1000 amu was monitored in full scan, and 80-1000 amu in the AIF experiments.

## Data Analysis

Data was collected and analyzed using Thermo Scientific TraceFinder 2.1 software. Spectral confirmation was carried out with Thermo Scientific ExactFinder, 2.0 software.

TABLE 1. HPLC gradients for the loading and analytical pumps in the method

Time (min)	Loading Pump %A	Flow Rate (μL/min)	Time (min)	Analytical Pump %A	Analytical Pump %B	Flow Rate (μL/min)
0.0	100	1000	0.0	98	2	350
1.3	100	1000	1.5	98	2	350
1.5	100	100	3.0	70	30	350
12.0	100	100	8.0	2	98	350
12.1	100	1000	9.0	2	98	350
15.0	100	1000	9.1	98	2	350
			15.0	98	2	350

FIGURE 1. EQuan MAX system flow schematic

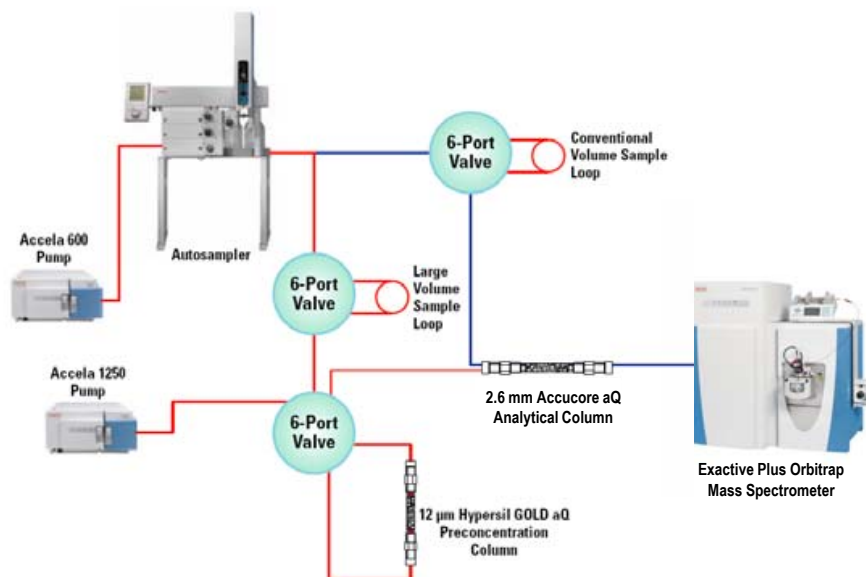

# Results

## Quantitation

Acquisition and quantitation was carried out using TraceFinder™ software. The theoretical mass of each protonated antibiotic compound was used as the mass for quantitation in this analysis. Calibration lines were created for each compound, and fit with either a linear or quadratic curve. Each calibration level was run in triplicate. Due to the large concentration range of the standards, some compounds exhibited non-linear calibration lines, and were fitted with a quadratic fit. All calibrators used a 1/X weighting. An example calibration line for the compound sulfamerazine is shown in Figure 2. The chromatogram shown in Figure 2 corresponds to the second to lowest level, 3 pg/mL.

**FIGURE 2. TraceFinder screen shot for the quantitation of the antibiotic sulfamerazine at 3 pg/mL**



## Limits of Quantitation

The limit of quantitation (LOQ) was determined by the lowest calibration standard group with a %RSD of less than 15%. The LOQ for this experiment is shown in Table 2. The %RSD for each compound at its LOQ is included in Table 2. In some cases, the LOQ was lower than the concentration of the lowest calibration standard.

**TABLE 2. List of antibiotics analyzed with their theoretical masses, LOQs and reproducibility**

<b>Compound</b>	<b>Theoretical Mass (<i>m/z</i>)</b>	<b>LOQ (pg/mL)</b>	<b>% RSD at LOQ</b>
Carbamazepine	332.14050	0.2	8.90
Erythromycin	734.46852	40.0	14.30
Ketoprofen	255.10157	1.0	9.90
Norethindrone	299.20056	1.0	13.50
Roxithromycin	837.53185	9.9	4.20
Sulfachloropyridazine	285.02075	1.0	7.30
Sulfadimethoxine	311.08085	0.4	4.80
Sulfamerazine	265.07537	0.6	4.90
Sulfamethazine	279.09102	1.0	3.45
Sulfamethizole	256.02089	1.0	6.30
Sulfamethoxazole	254.05939	1.0	6.60
Sulfathiazole	271.03179	0.6	3.60
Trimethoprim	291.14517	1.6	13.10

### **Spectral Confirmation**

To add additional confirmation to the antibiotics detected in the samples, spectral confirmation of the MS<sup>2</sup> spectrum collected in the HCD cell was performed using ExactFinder™ software. Samples were submitted to the software after acquisition. The MS<sup>2</sup> spectra were searched against the built-in Environmental and Food Safety and Clinical Research spectral libraries. These libraries contain MS<sup>2</sup> spectra collected on Orbitrap instruments. Because all Orbitrap platform mass spectrometers are compatible, they provide identical spectra.

The spectral match for the antibiotic trimethoprim is shown in Figure 4. This comparison is from the HCD MS<sup>2</sup> spectrum of the calibration standard corresponding to a concentration of 80 pg/mL. The top spectrum is the library reference spectrum. The bottom spectrum is the collected sample spectrum. The library reference spectrum is cleaner, because it was collected using a Thermo Scientific LTQ Velos Pro Orbitrap mass spectrometer by direct infusion. Thus, there is much less background, no co-eluting peaks, or matrix to generate extraneous ions. Nevertheless, the two spectra match in the main fragment peaks, as well as the protonated molecular ion at *m/z* = 291.1446 amu. This spectral confirmation helps to eliminate the possibility of false-positives, and can be used for identification point scoring systems.



**FIGURE 4. Spectral comparison of the MS<sup>2</sup> spectrum of the antibiotic trimethoprim obtained at a concentration of 80 pg/mL. The library reference spectrum is the top spectrum, the lower spectrum is from the sample. The comparison was performed with ExactFinder software.**

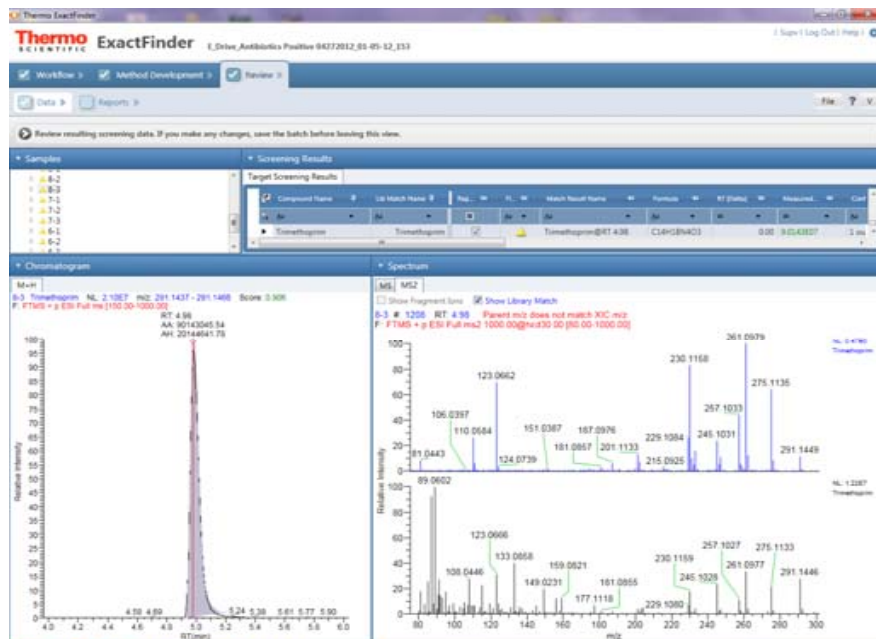

## Conclusion

This poster demonstrates:

- Online pre-concentration and extraction for 1mL injections of antibiotics at the ppt level.
- The quantitation of HR/AM data using TraceFinder software from the Exactive Plus Orbitrap instrument.
- Spectral confirmation of MS<sup>2</sup> spectrum collected in the same data file as the quantitation data using ExactFinder software.
- Ability to quantitate and confirm samples in the same analytical run for antibiotics in water samples.

## Acknowledgements

We would like to thank Paul Yang from the Ontario Ministry for the Environment for supplying the antibiotic standards for this analysis.

[www.thermofisher.com](http://www.thermofisher.com)

©2016 Thermo Fisher Scientific Inc. All rights reserved. All trademarks are the property of Thermo Fisher Scientific Inc. and its subsidiaries. This information is presented as an example of the capabilities of Thermo Fisher Scientific Inc. products. It is not intended to encourage use of these products in any manners that might infringe the intellectual property rights of others. Specifications, terms and pricing are subject to change. Not all products are available in all countries. Please consult your local sales representative for details.

**Africa-Other** +27 11 570 1840  
**Australia** +61 3 9757 4300  
**Austria** +43 1 333 50 34 0  
**Belgium** +32 53 73 42 41  
**Canada** +1 800 530 8447  
**China** +86 10 8419 3588  
**Denmark** +45 70 23 62 60

**Europe-Other** +43 1 333 50 34 0  
**Finland/Norway/Sweden**  
+46 8 556 468 00  
**France** +33 1 60 92 48 00  
**Germany** +49 6103 408 1014  
**India** +91 22 6742 9434  
**Italy** +39 02 950 591

**Japan** +81 45 453 9100  
**Latin America** +1 561 688 8700  
**Middle East** +43 1 333 50 34 0  
**Netherlands** +31 76 579 55 55  
**New Zealand** +64 9 980 6700  
**Russia/CIS** +43 1 333 50 34 0  
**South Africa** +27 11 570 1840

**Spain** +34 914 845 965  
**Switzerland** +41 61 716 77 00  
**UK** +44 1442 233555  
**USA** +1 800 532 4752

PN63619\_E 08/16S

**Thermo**  
S C I E N T I F I C  
Part of Thermo Fisher Scientific



# Detection of Pharmaceuticals, Personal Care Products, and Pesticides in Water Resources by APCI-LC-MS/MS

Liza Viglino<sup>1</sup>, Khadija Aboufald<sup>1</sup>, Michèle Prévost<sup>2</sup>, and Sébastien Sauvé<sup>1</sup>

<sup>1</sup>Department of Chemistry, Université de Montréal, Montréal, QC, Canada; <sup>2</sup>Département of Civil, Geological, and Mining Engineering, École Polytechnique de Montréal, Montréal, QC, Canada

## Introduction

Pharmaceuticals (PhACs), personal care product compounds (PCPs), and endocrine disruptors (EDCs), such as pesticides, detected in surface and drinking waters are an issue of increasing international attention due to potential environmental impacts<sup>1,2</sup>. These compounds are distributed widely in surface waters from human and animal urine, as well as improper disposal, posing a potential health concern to humans via the consumption of drinking water. This presents a major challenge to water treatment facilities.

Collectively referred to as organic wastewater contaminants (OWCs), the distribution of these emerging contaminants near sewage treatment plants (STP) is currently an area of investigation in Canada and elsewhere<sup>3,4</sup>. More specifically, some of these compounds have been detected in most effluent-receiving rivers of Ontario and Québec<sup>5,6</sup>. However, it is not clear whether contamination is localized to areas a few meters from STP discharges or whether these compounds are distributed widely in surface waters, potentially contaminating sources of drinking water.

A research project at the University of Montreal's Chemistry Department and Civil, Geological, and Mining Engineering Department was undertaken to establish the occurrence and identify the major sources of these compounds in drinking water intakes in surface waters in the Montreal region. The identification and quantification of PhACs, PCPs, and EDCs is critical to determine the need for advanced processes such as ozonation and adsorption in treatment upgrades.

The establishment of occurrence data is challenging because of: (1) the large number and chemical diversity of the compounds of interest; (2) the need to quantify low levels in an organic matrix; and (3) the complexity of sample concentration techniques. To address these issues, scientists traditionally use a solid phase extraction (SPE) method to concentrate the analytes and remove matrix components.

After extraction, several different analytical techniques may perform the actual detection such as GC-MS/MS and more recently, LC-MS/MS<sup>7,8</sup>. Another analytical challenge resides in the different physicochemical characteristics and wide polarity range of organic compounds – making simultaneous preconcentration, chromatography separation, and determination difficult. Analytical

methods capable of detecting multiple classes of emerging contaminants would be very useful to any environmental monitoring program. However, up to now, it has often been a necessity to employ a combination of multiple analytical techniques in order to cover a wide range of trace contaminants<sup>9</sup>. This can add significant costs to analyses, including equipment, labor, and time investments.

## Goals

To develop a simple method for the simultaneous determination of trace levels of compounds from a diverse group of pharmaceuticals, pesticides, and personal care products using SPE and liquid chromatography-tandem mass spectrometry (LC-MS/MS).

Determine which selected substances are present in significant quantities in the water resources around the Montreal region.

## Materials and Method

### Analyte selection

Compounds were selected from a list of the most-frequently encountered OWCs in Canada<sup>4,6</sup> (Figure 1).

### Sample collection

Raw water samples were taken from the Mille Îles, des Prairies, and St-Laurent rivers. Three samples were collected at the same time from each river in pre-cleaned, four-liter glass bottles and kept on ice while being transported to the laboratory. These water sources vary widely due to wastewater contamination and sewer overflow discharges.

All samples were acidified with H<sub>2</sub>SO<sub>4</sub> for sample preservation and stored in the dark at 4 °C. Immediately before analysis, samples were filtered using 0.7 µm pore-size fiberglass filters followed by 0.45 µm pore size mixed-cellulose membranes (Millipore, MA, USA). Samples were extracted within 24 hours of collection.

## Key Words

- TSQ Quantum Ultra
- Water Analysis
- Solid Phase Extraction

## Personal Care Products

### Caffeine (CAF)

MW: 194.19, pKa = 10.4,  
Stimulant

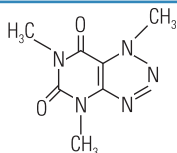

### Triclocarban (TCC)

MW: 315.19,  
Anti-bacterial agent

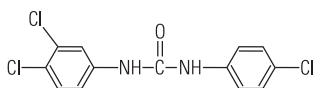

## Pharmaceuticals

### Carbamazepine (CBZ)

MW: 236.27, pKa = 13.9,  
Anticonvulsant

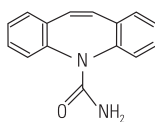

### Clofibric acid

MW: 214.65  
Metabolite lipid regulator

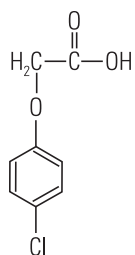

### Naproxen (NAPRO)

MW: 230.26, pKa = 4.15  
Analgesic

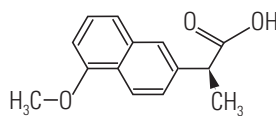

### Gemfibrozil (GEM)

MW: 250.33,  
Anti-cholesterol

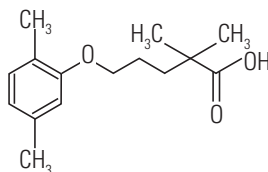

### Salicylic acid

MW: 138.12  
Metabolite of acetylsalicylic acid (aspirin)

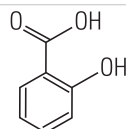

### Trimethoprim (TRI)

MW: 290.30, pKa = 7.12  
Anti-infective

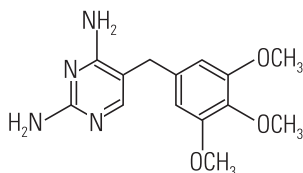

## Hormones

### Estrone

MW: 270.4  
Estrogen

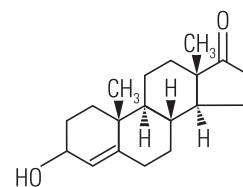

### Estriol

MW: 288.4  
Estrogen

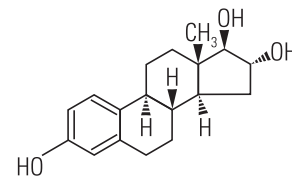

### Estradiol

MW: 272.4  
Estrogen

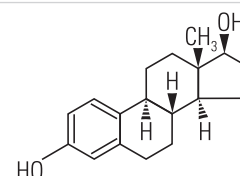

### Progesterone

MW: 314.15  
Progestogen

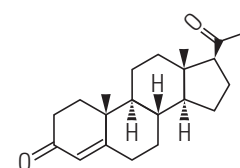

### 17- $\alpha$ -Ethinylestradiol

MW: 296.4  
Synthetic estrogen

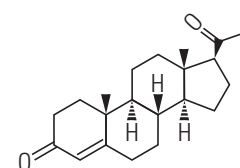

## Pesticide

### Atrazine (ATRA)

MW: 215.68,  
pKa = 1.7,  
Herbicide

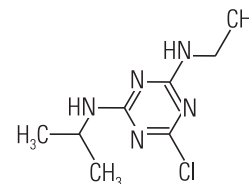

Figure 1: Molecular structures of selected compounds

## Concentration and Extraction Procedure

The solid phase extraction procedure is illustrated in Figure 2. Briefly, analytes were concentrated and extracted using a 200 mg C18-like analytical cartridge. Retained analytes were eluted from the cartridges using 3 mL MTBE:MeOH 90/10 and 3 mL MeOH. They were then collected on the conical-bottom centrifuge tube for evaporation to dryness with N<sub>2</sub> (g). Extracted analytes were reconstituted to 200  $\mu$ L with 90% water/formic acid 0.1% and 5% MeOH solution containing the internal standards.

### LC-MS/MS conditions

HPLC separation was done with a Thermo Scientific Surveyor HPLC system. Separation conditions are given in Table 1. Detection and quantification of the analytes were performed with a Thermo Scientific TSQ Quantum Ultra triple stage quadrupole mass spectrometer using selective reaction monitoring (SRM) (Table 2). Preliminary experiments were performed with two atmospheric pressure ionization (API) sources – ESI and APCI – to detect all compounds. Although some compounds showed a slightly higher intensity with the ESI source (i.e. atrazine), APCI was selected because of the higher sensitivity provided for steroids. This endocrine disruption class is an important analytical challenge due to the low detection limits (1 ng/L) required for the determination of these compounds. These compounds are known to affect the living organisms at very low concentrations. Given that the aim was to develop a simple analytical method to detect as wide a range of compounds as possible, we selected the APCI source. The small loss in sensitivity for some easily measured molecules was more than compensated by the gain in sensitivity for other compounds that could not have been detected using ESI. Moreover, APCI ionization is known in some cases to be less susceptible to matrix interferences than ESI ionization<sup>10</sup>. Lastly, some authors demonstrated signal suppression for analysis of various organic waste compounds in water samples using ESI-LC-MS/MS<sup>11</sup>.

The identification of analytes was confirmed by the LC retention time<sup>12,13</sup>. Instrument control and data acquisition were performed with Thermo Scientific Xcalibur software.

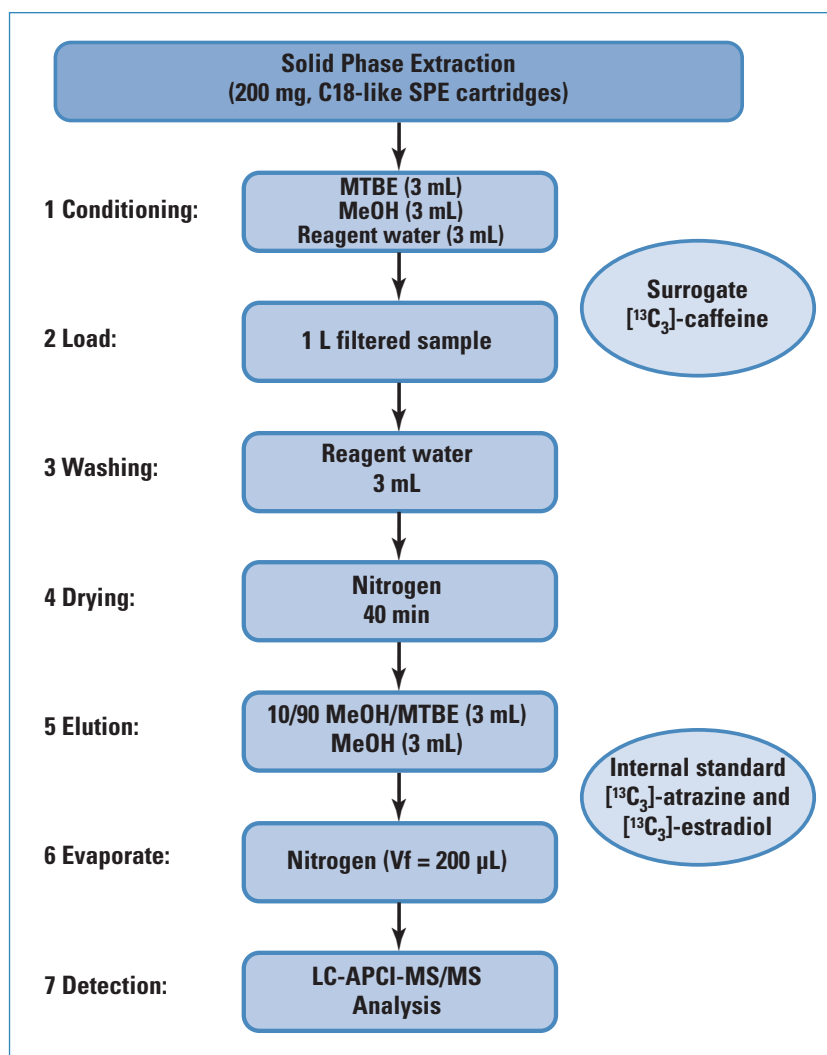

Figure 2: SPE enrichment procedure

Table 1: Instrument Parameters

HPLC		MS		
Column:	Thermo Scientific Hypersil GOLD (50 x 2.1 mm, 3 µm)	Ionization mode:	APCI <sup>+</sup>	APCI <sup>-</sup>
Column temperature:	30 °C	Discharge current:	3 µA	4 µA
Mobile phase A:	0.1% Formic acid/H <sub>2</sub> O	Vaporizer temperature:	500 °C	500 °C
Mobile phase B:	MeOH	Capillary temperature:	250 °C	250 °C
Injection volume:	20 µL	Sheath gas pressure:	40 arb units	30 arb units
Flow rate:	500 µL/min	Aux. gas pressure:	20 arb units	15 arb units
Gradient:	T=0, A=90%, B=10%	Collision gas pressure:	1.5 mTorr	1.5 mTorr
	T=1, A=90%, B=10%	Source CID:	-10 V	15 V
	T=15, A=1%, B=99%			
	T=16.5, A=1%, B=99%			
	T=17, A=90%, B=10%			
	T=22, A=90%, B=10%			

**Table 2: SRM transitions used for detection and quantification**

Compound	Precursor ion (m/z)	Product ion (m/z)	CE (eV)	Tube lens (V)
Trimethoprim	291.16	230.16	22	90
Caffeine	195.10	138.10	18	77
Estriol	271.24	157.10	18	80
Carbamazepine	237.11	194.10	20	80
Atrazine	216.11	174.10	34	97
Naproxen	231.11	185.10	13	101
17- $\alpha$ -Ethinylestradiol	279.16	133.10	31	86
Estradiol	255.16	159.10	17	79
Estrone	271.24	157.10	18	80
Progesterone	315.26	109.10	38	118
TCC	316.99	127.04	32	99
Gemfibrozil	251.09	129.10	20	118
Salicylic acid*	137.04	93.10	31	72
Clofibric acid*	213.17	127.10	32	102

\*APCI-

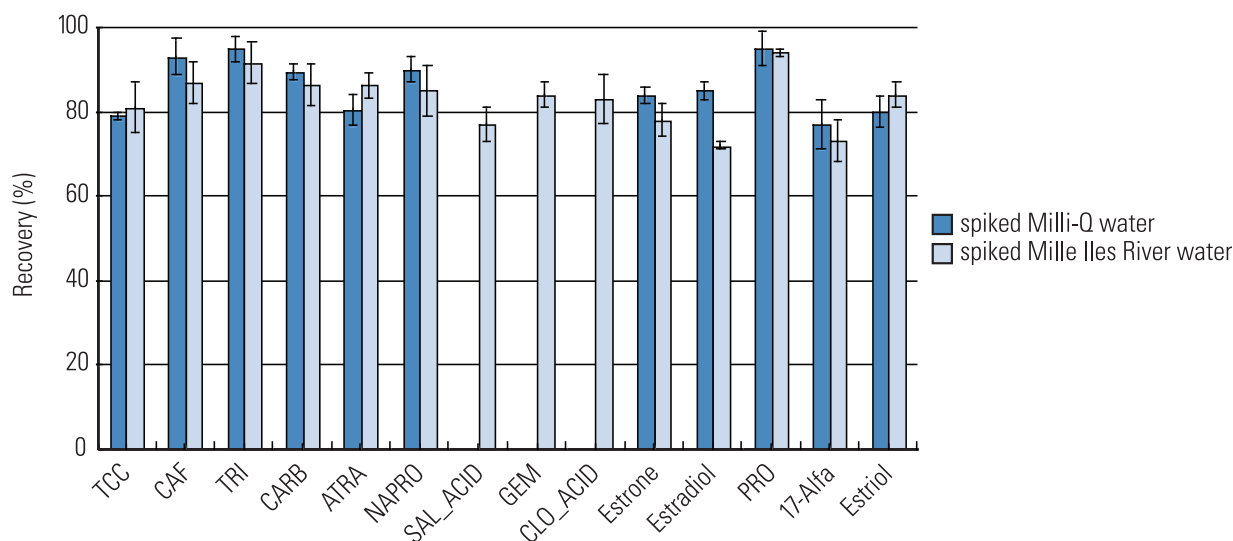

Figure 3: Mean recoveries for the extraction of selected compounds using C18-like cartridges (spiked in Milli-Q water and Mille Iles River water at 50 ng/L, n=6)

## Results and Discussion

Reproducibility (%RSD), ranging from 3% to 11% for all analytes, was very good. Accuracy (recovery percentages), ranging between 72% to 94% for all compounds in spiked matrix, was satisfactory and indicated high performance of our method. Results are shown in Table 3.

Matrix effects are very important when developing an LC-MS/MS method and can affect reproducibility and accuracy<sup>14</sup>. This phenomenon was evaluated by comparing recovery percentages in Milli-Q<sup>®</sup> water and surface water samples (Mille Iles River) spiked at 50 ng/L (n = 6). We can consider a very low matrix effect in surface waters since signal suppression varies from 1% to 13%, except for atrazine and TCC showing an enhancement signal of 6% and 2%, respectively (Figure 3).

Good linearity in surface water samples was observed over a concentration range from <LOD to 100 ng/L with correlation coefficients greater than 0.99 for all compounds. Detection limits in surface water were in the range of 0.03 to 2 ng/L (Table 3).

The compounds of interest were investigated using samples from various surface waters. Figure 4 shows representative LC-MS/MS chromatograms of selected compounds in surface water. The concentrations are illustrated in Figure 5. The selected compounds were detected in all river samples at various concentrations depending on sampling locations (Figure 5 a and b). The highest concentrations were found for caffeine (16-24 ng/L), atrazine (1.5-39 ng/L), salicylic acid (10-33 ng/L) and gemfibrozil (4-14 ng/L). The lowest concentrations were found for carbamazepine (3-5 ng/L), clofibric acid, and two hormones (progesterone and estradiol). Trimethoprim, triclocarban and other selected hormones were detected at trace levels (Trace  $\leq$  limit of detection).

Overall, concentrations of most of the compounds analysed were similar to those reported from other areas in Canada and Europe<sup>3,4</sup>.



**Table 3: Retention time, limit of detection (LOD), linearity, recoveries and RSD (%) data for each detected compounds in tap water.**

Compound	Retention time (min)	LOD* (ng/L)	R <sup>2</sup> **	Recovery***(%)	RSD (%)
Trimethoprim	5.46	0.50	0.9998	91	7
Caffeine	5.79	0.07	0.9995	87	9
Estriol	10.14	0.30	0.9981	84	9
Carbamazepine	10.76	0.09	0.9999	86	5
Atrazine	11.41	0.03	0.9995	86	3
Naproxen	12.62	2.00	0.9996	85	9
17- $\alpha$ -Ethinylestradiol	12.85	0.50	0.9931	73	10
Estradiol	12.88	0.10	0.9979	72	6
Estrone	12.94	0.60	0.9989	79	9
Progesterone	14.44	0.08	0.9994	94	4
TCC	15.10	0.20	0.9970	81	10
Gemfibrozil	15.17	2.00	0.9991	84	6
Salicylic acid	8.82	0.90	0.9993	77	6
Clofibric acid	12.00	0.60	0.9989	83	11

\*LOD in surface water (Mille lles River)

\*\*Value for calibration line in river water (0-100 ng/L)

\*\*\*Recoveries over the total method (surface samples spiked at 50 ng/L, n = 6).

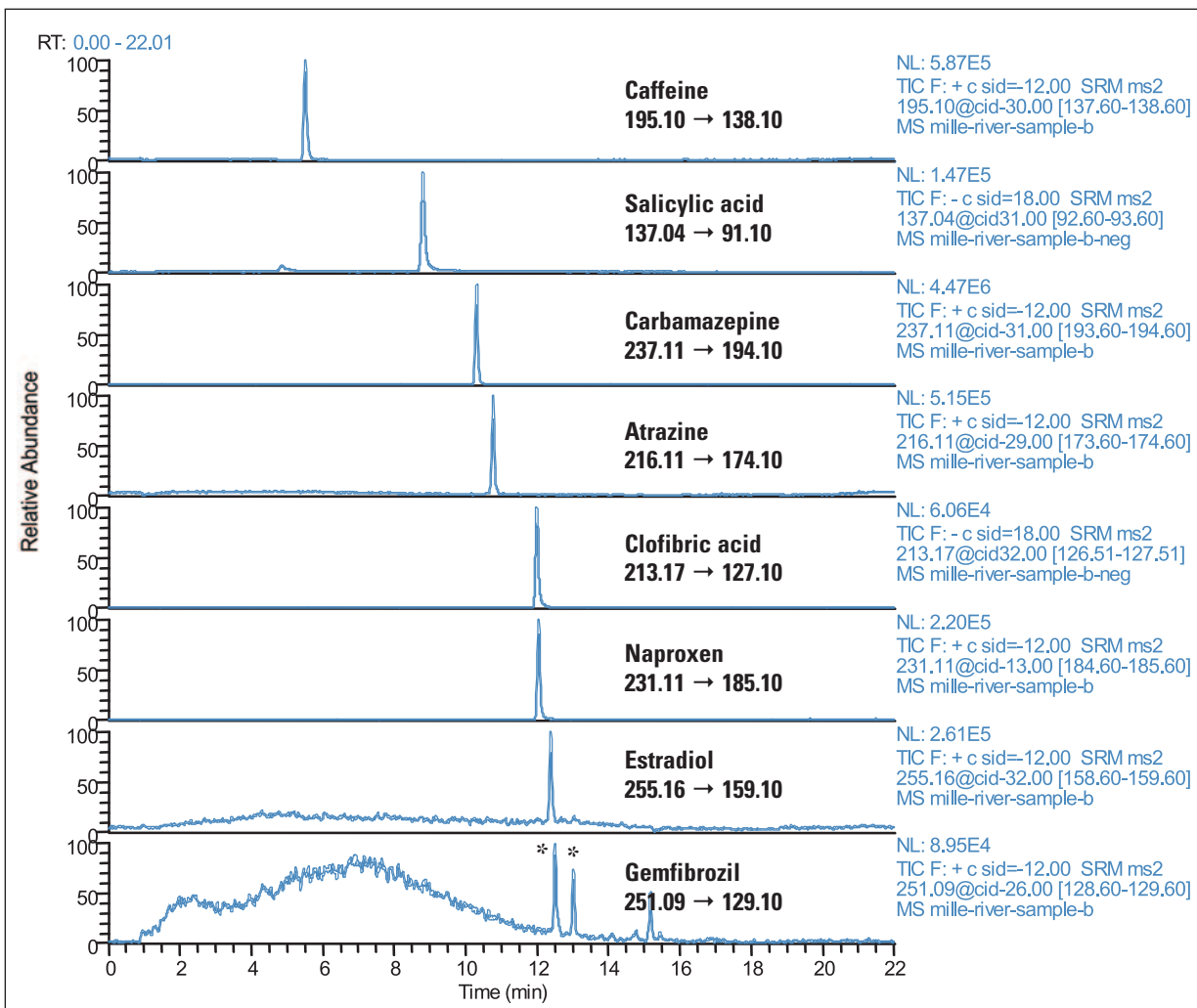

Figure 4: Representative SRM chromatograms of some selected compounds detected in water matrix (Mille lles River). Peak due to interferences are marked by asterisks (\*)

## Conclusion

We developed and successfully applied an APCI-LC-MS/MS method for quantifying a wide range of compounds from a diverse group of pharmaceuticals, pesticides, and personal care products at concentration in the low ng/L range in surface waters with good precision and accuracy. Results confirmed the presence of pharmaceuticals, personal care products, and endocrine disruptors in all water resources around the region of Montreal. The concentrations of compounds fluctuated with sampling locations due to the variation of these sources, wastewater contamination and combined sewer overflow discharges.

## References

1. T. A. Ternes and A. Joss, Eds., Human Pharmaceuticals, Hormones and Fragrances: The Challenge of Micropollutants in Urban Water Management, IWA, 2006, p 443.
2. A. Kortenkamp, *Env. Health Perspective*, 2007, pp 1-42.
3. C. Hao, L. Lissemore, B. Nguyen, S. Kleywegt, P. Yang, K. Solomon, *Anal. Bioanal. Chem.*, 2006, 384, 505-513.
4. C. D. Metcalfe, X-S Mia, W. Hua, R. Letcher, M. Servos, *Pharmaceuticals in the Canadian Environment. In Pharmaceuticals in the Environment: Sources, Fate, Effects and Risks*, second edition; K. Kummerer, Ed.; Springer-Verlag, 2004, 67-87.
5. F. Gagné, C. Blaise, C. André, *Ecotoxicology and Environmental Safety* 2006, 64, 329-336.
6. P. A. Segura, A. Garcia-Ac, A. Lajeunesse, D. Ghosh, C. Gagnon and S. Sauvè, *J. Environ. Monitor.*, 2007, 9, 307-313.
7. R. A. Trenholm, B. J. Vanderford, J. C. Holady, D. J. Rexing and S. A. Snyder, *Chemosphere*, 2006, 65(11), 1990-1998.
8. C. Zwiener and F. H. Frimmel, *Anal. Bioanal. Chem.*, 2004, 378, 862-874.
9. T. A. Ternes, *Trends Anal. Chem.*, 2001, 20(8), 419-434.
10. S. Souverain, S. Rudaz, J-L. Venthey, *J. Chrom. A*, 2004, 1058, 61-66.
11. B. J. Vanderford, R. A. Pearson, D. J. Rexing and S. A. Snyder, *Anal. Chem.*, 2003, 6265-6274.
12. J. B. Schilling, S. P. Cepa, S. D. Menacherry, L. T. Barda, B. M. Heard and B. L. Stockwell, *Anal. Chem.*, 1996, 68, 1905.
13. L. Y. T. Li, D. A. Campbell, P. K. Bennett and J. D. Henion, *Anal. Chem.*, 1996, 68, 3397.
14. T. Reemtsa, *Trends Anal. Chem.*, 2001, 20, 533-542.

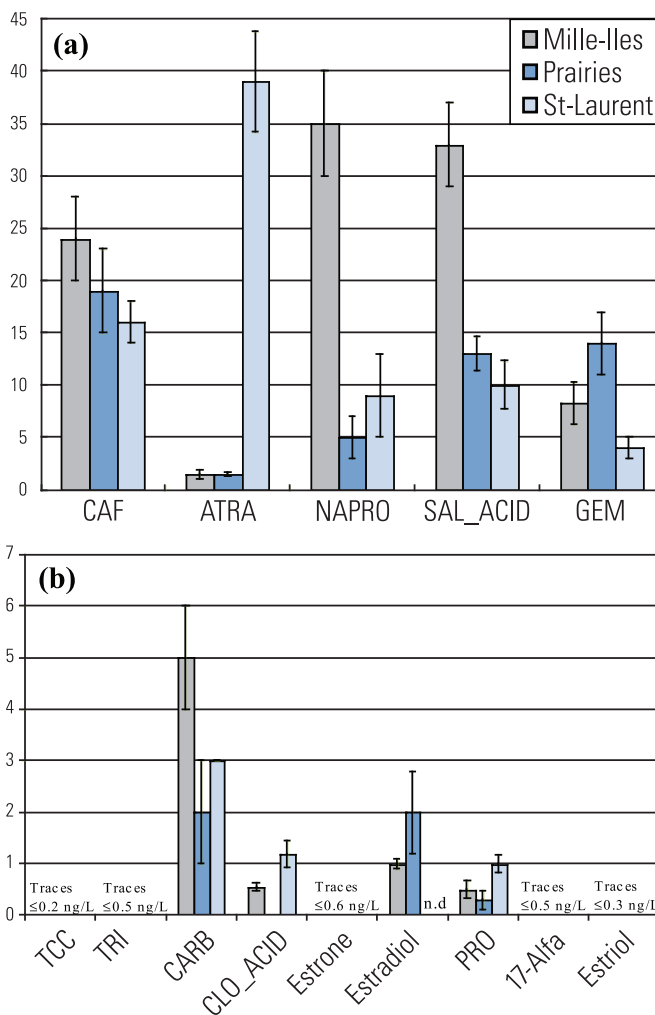

Figure 5: (a) The highest mean concentrations of selected compounds in water samples collected from Mille-Iles River, des Prairies River and St-Laurent River (n = 6). (b) The lowest mean concentrations of selected compounds in water samples collected from Mille Iles River, des Prairies River and St-Laurent River (n = 6).

## Legal Notices

©2016 Thermo Fisher Scientific Inc. All rights reserved. Milli-Q is a registered trademark of Millipore Corporation. All other trademarks are the property of Thermo Fisher Scientific Inc. and its subsidiaries. This information is presented as an example of the capabilities of Thermo Fisher Scientific Inc. products. It is not intended to encourage use of these products in any manners that might infringe the intellectual property rights of others. Specifications, terms and pricing are subject to change. Not all products are available in all countries. Please consult your local sales representative for details.

View additional Thermo Scientific LC/MS application notes at: [www.thermo.com/appnotes](http://www.thermo.com/appnotes)

In addition to these offices, Thermo Fisher Scientific maintains a network of representative organizations throughout the world.

**Africa-Other**  
+27 11 570 1840

**Australia**  
+61 2 8844 9500

**Austria**  
+43 1 333 50 34 0

**Belgium**  
+32 2 482 30 30

**Canada**  
+1 800 530 8447

**China**  
+86 10 8419 3588

**Denmark**  
+45 70 23 62 60

**Europe-Other**  
+43 1 333 50 34 0

**Finland/Norway/Sweden**  
+46 8 556 468 00

**France**  
+33 1 60 92 48 00

**Germany**  
+49 6103 408 1014

**India**  
+91 22 6742 9434

**Italy**  
+39 02 950 591

**Japan**  
+81 45 453 9100

**Latin America**  
+1 608 276 5659

**Middle East**  
+43 1 333 50 34 0

**Netherlands**  
+31 76 579 55 55

**South Africa**  
+27 11 570 1840

**Spain**  
+34 914 845 965

**Switzerland**  
+41 61 716 77 00

**UK**  
+44 1442 233555

**USA**  
+1 800 532 4752

[www.thermo.com](http://www.thermo.com)

AN63041\_E 08/16S

# Quantification of EPA 1694 Pharmaceuticals and Personal Care Products in Water at the ng/L Level Utilizing Online Sample Preparation with LC-MS/MS

Kevin McHale, Mark Sanders; Thermo Fisher Scientific, Somerset, NJ

## Introduction

There is growing environmental concern regarding the health impact of trace levels of pharmaceuticals and personal care products (PPCPs) in water resources. In response to this concern, the U.S. Environmental Protection Agency (EPA) recently published Method 1694, which determines dozens of PPCPs in water, soil, sediment, and biosolids by high performance liquid chromatography combined with tandem mass spectrometry (HPLC-MS/MS).<sup>1</sup> The method, which is yet to be promulgated, uses solid phase extraction (SPE) of water samples followed by HPLC-MS/MS analysis using a single transition for each compound to achieve low nanogram/liter (ng/L) limits of quantitation (LOQs).

The target analytes in the EPA method are divided into four groups, with each group representing one HPLC-MS/MS run. Three of the groups are extracted under acidic conditions; the fourth is extracted under basic conditions. These SPE methods can use up to 1 L of sample. Although not sample limited, the storage of large bottles of water requires a great deal of refrigeration space. In addition, manual SPE of 1 L of sample requires several hours of preparation.

One of the opportunities in the analysis of PPCPs in water is to reduce the time required for sample preparation and analysis while maintaining the required sensitivity at the ng/L level and the selectivity to positively identify the analyte of interest. We describe a method for online sample preparation and analysis using the Thermo Scientific EQuan system. This method couples a fast HPLC system with two LC columns – one for pre-concentration of the sample, the second for the analytical analysis – and an LC-MS/MS instrument. Instead of processing 1 L of water by the manual, time-consuming process of SPE described in EPA Method 1694, this alternative approach incorporates online sample preparation in series with LC-MS/MS using smaller volumes of water (0.5-20 mL) to achieve ng/L quantitation limits.

## Goal

To demonstrate a progressive approach to analyzing PPCPs in environmental sources of water at the ng/L level with online sample preparation using small volumes of water, thus saving time and reducing the cost of analysis.

## Experimental Conditions

The EQuan LC-MS/MS experimental setup is illustrated in Figure 1.

## Sample Preparation

Aqueous solutions containing 5% – 20% acetonitrile (ACN) and adjusted to pH 2.9, 6.6 or 11.3 were spiked with more than 60 PPCPs at the low ng/L level.

## HPLC

Water samples of 0.5 mL were directly injected onto a Thermo Scientific Hypersil GOLD aQ pre-concentration trapping column (2.1 x 20 mm, 12 µm) at 1.5 mL/min with H<sub>2</sub>O + 0.2% formic acid. After sufficient washing of the pre-concentration column, the target compounds were transferred to the Thermo Scientific Betasil C18 analytical column (2.1 x 100 mm, 3 µm) for chromatographic separation by gradient elution prior to introduction into the mass spectrometer.

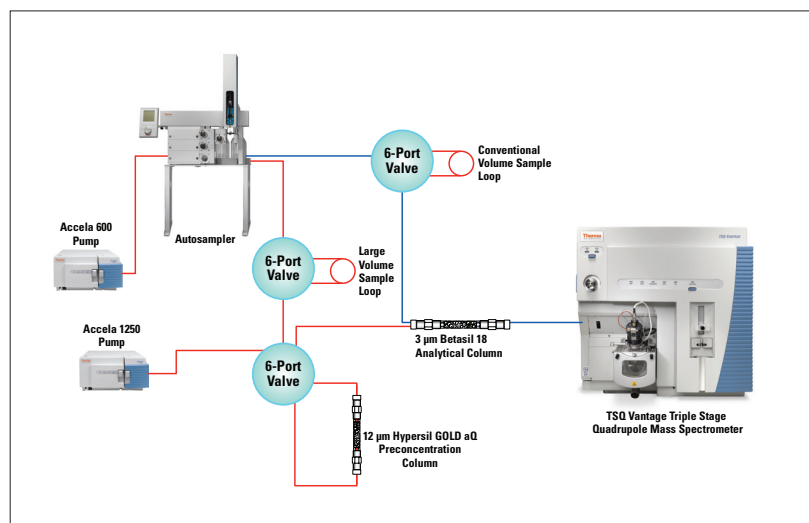

Figure 1. The EQuan pre-concentration LC-MS/MS experimental setup.

## Key Words

- EQuan System
- TSQ Vantage
- PPCPs
- Water Analysis

## MS

MS analysis was carried out on a Thermo Scientific TSQ Vantage triple stage quadrupole mass spectrometer. Two selected reaction monitoring (SRM) transitions per compound were acquired: one for quantitation and the other for positive confirmation. To maximize the performance of the triple stage quadrupole, time-specific SRM “windows” were employed at the retention times of the target compounds.

## Results and Discussion

The current EPA Method 1694 describes three different LC methods for PPCPs from Groups 1, 2, and 4, which are amenable to positive electrospray ionization (ESI) MS/MS. To simplify the method and reduce the total analysis time, a single 10-minute LC-MS/MS method was developed, which included compounds from additional pharmaceutical classes not included in EPA Method 1694, such as beta-blockers. In total, 67 compounds were analyzed by positive ESI-MS/MS (Table 1). Of these, 54 were from EPA Method 1694 Groups 1, 2, and 4.

Table 1. PPCPs analyzed

Compound	Class	Compound	Class
Trimethoprim	Antibiotic	4-epi-Chlorotetracycline	Antibiotic, tetracycline
Cefotaxime	Antibiotic, cephalosporin	Demeclocycline	Antibiotic, tetracycline
Norflloxacin	Antibiotic, fluoroquinolone	Chlorotetracycline	Antibiotic, tetracycline
Ofloxacin	Antibiotic, fluoroquinolone	Doxycycline	Antibiotic, tetracycline
Ciprofloxacin	Antibiotic, fluoroquinolone	Anhydrotetracycline	Antibiotic, tetracycline
Lomefloxacin	Antibiotic, fluoroquinolone	Carbamazepine	Anticonvulsant
Enrofloxacin	Antibiotic, fluoroquinolone	Fluoxetine	Antidepressant
Sarafloxacin	Antibiotic, fluoroquinolone	Miconazole	Antifungal
Flumequine	Antibiotic, fluoroquinolone	Thiabendazole	Anthelmintic
Lincomycin	Antibiotic, macrolide	Diphenhydramine	Antihistamine
Azithromycin	Antibiotic, macrolide	Acetaminophen	Analgesic
Erythromycin	Antibiotic, macrolide	Codeine	Analgesic, narcotic
Tylosin	Antibiotic, macrolide	Cimetidine	Antiacid reflux
Anhydroerythromycin	Antibiotic, macrolide	Ranitidine	Antiacid reflux
Clarithromycin	Antibiotic, macrolide	Digoxigenin	Antiarrhythmic
Roxithromycin	Antibiotic, macrolide	Digoxin	Antiarrhythmic
Ampicillin	Antibiotic, penicillin	Diltiazem	Antiarrhythmic, benzothiazepine
Penicillin G	Antibiotic, penicillin	Dextromethorphan**	Antitussive
Penicillin V	Antibiotic, penicillin	Atenolol	Beta-blocker
Oxacillin	Antibiotic, penicillin	Metoprolol	Beta-blocker
Cloxacillin	Antibiotic, penicillin	Propranolol	Beta-blocker
Metformin*	Antidiabetic	Albuterol	Bronchodilator
Sulfadiazine	Antibiotic, sulfa	Midazolam	Sedative, benzodiazepine
Sulfathiazole	Antibiotic, sulfa	1-OH Midazolam	Sedative, benzodiazepine
Sulfamerazine	Antibiotic, sulfa	1-OH Alprazolam	Sedative, benzodiazepine
Sulfamethazine	Antibiotic, sulfa	Alprazolam	Sedative, benzodiazepine
Sulfamethizole	Antibiotic, sulfa	Nordiazepam	Sedative, benzodiazepine
Sulfachloropyridazine	Antibiotic, sulfa	1,7-Dimethylxanthine	Stimulant
Sulfamethoxazole	Antibiotic, sulfa	Caffeine	Stimulant
Sulfadimethoxine	Antibiotic, sulfa	Benzylecgonine	Stimulant
Minocycline	Antibiotic, tetracycline	Cocaine	Stimulant
Oxytetracycline	Antibiotic, tetracycline	Cocaethylene	Stimulant
4-epi-Tetracycline	Antibiotic, tetracycline	Cotinine	Stimulant
Tetracycline	Antibiotic, tetracycline		

\*Metformin was analyzed using HILIC

\*\*PPCPs not included in EPA 1694

With such a diverse range of chemical classes, the challenge was in developing a single LC-MS/MS method without compromising the target ng/L sensitivity. Both sample pH and the % ACN in the sample affected the response of PPCPs in water when employing the online sample preparation approach with the EQUAN system. To determine the best method for achieving ng/L sensitivity on the TSQ Vantage™ mass spectrometer, the effects of sample pH and %ACN were investigated.

### Effects of Sample pH

Sample pH was found to affect the response of some PPCPs in water based on chemical reactivity. During the method development, PPCPs were added to aqueous solutions at three different pHs: 2.9, 6.6, and 11.3. As shown in the chromatograms in Figure 2, chlorotetracycline (CTC) was readily observed at pH 2.9 and pH 6.6. However, at pH 11.3, CTC completely disappeared, being converted to 4-epi-CTC. It is important to note that no 4-epi-CTC was added to the water samples prior to LC-MS/MS analysis. All of the 4-epi-CTC detected was due to the conversion of CTC, which has been shown to have a short half-life in solutions at pH 11.2. A similar effect was observed with erythromycin, which reacted quickly in acidic solution and converted to anhydroerythromycin at pH 2.9.

The pH also affected the solubility of some PPCPs, even within the same compound class. Figure 3 displays the area response for cloxacillin and penicillin. For cloxa-

cillin, the area response at pH 2.9 and pH 6.6 is evident in the bar chart at the top left; whereas at pH 11.3, cloxacillin was not observed. A similar effect was seen for ampicillin, oxacillin, cefotaxime, and diltiazem. However, the opposite effect was observed for penicillin V (and G), as seen in the bar chart in the bottom right. The same trends were observed with LC-MS/MS (5 µL injection) as with the EQUAN method (0.5 mL injection), indicating that this is a sample solubility effect.

The pH effect on the MS response was also observed with several other PPCPs when using the EQUAN system. Using ranitidine as an example, the MS response was much greater at pH 11.3 than at pH 2.9 or 6.6, as shown in the chart at the top left of Figure 4. However, this pH effect was not observed when using a 5 µL injection of the water samples directly onto the analytical column at the same mass loading of ranitidine, as seen in the bar chart in the lower right of Figure 4. This difference in response is believed to be attributed to the change in the local partitioning chemistry between ranitidine and the stationary phase of the pre-concentration column. With a 5 µL injection directly onto the analytical column, the partitioning chemistry was not affected for a long enough period to change the retention of ranitidine. Nevertheless, under the right sample solution conditions, namely pH 11.3 and 5%-10% ACN, ranitidine and other basic PPCPs, such as cimetidine, codeine, and lincomycin, yielded quantitative trapping recovery using the EQUAN system.

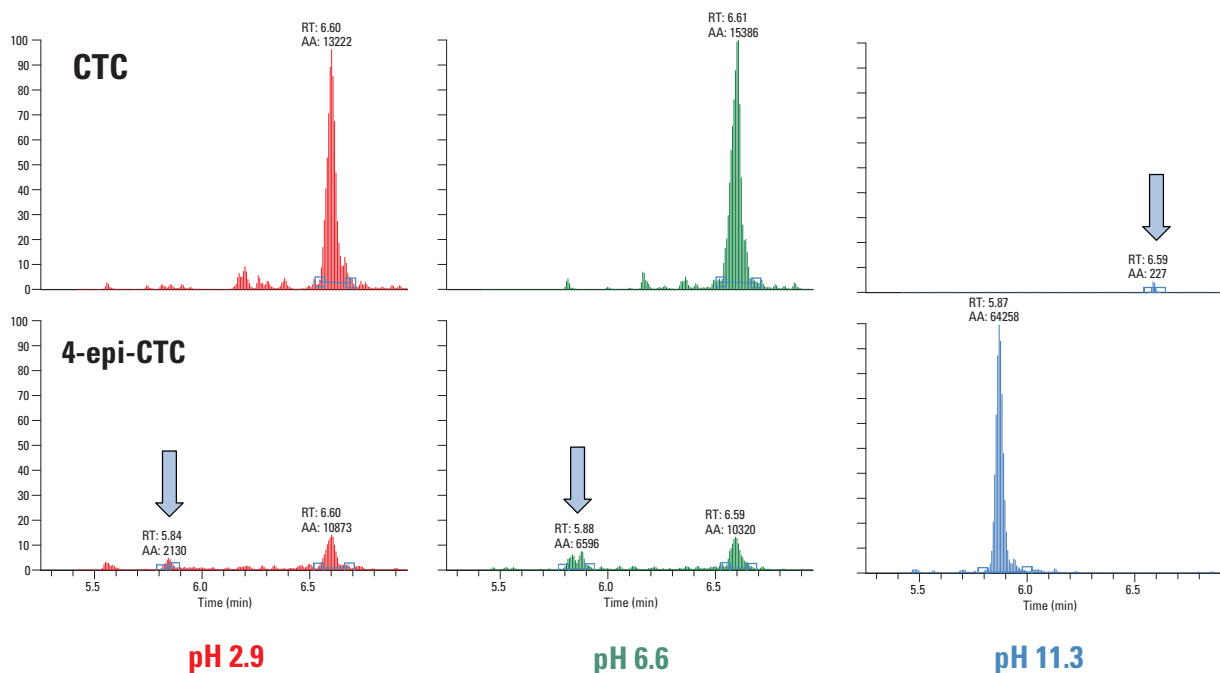

Figure 2. Chromatograms showing the pH effect on chlorotetracycline (CTC).

### Effects of %ACN

The effect on the LC-MS/MS response for the PPCPs was examined as a function of the % ACN in the water samples. Many of the larger, more lipophilic compounds, such as the macrolide antibiotics, showed a significant increase in area response as a function of increasing %ACN in the water sample. For tylosin and roxithromycin, the increased response was most dramatic between 5% and 10% ACN at pH 2.9. The area response increased by a factor of 3 for roxithromycin and a factor of 10 for tylosin when the %ACN was increased from 5% to 10%. The same trend was observed with LC-MS/MS (5  $\mu$ L injection) as with the EQUan system, indicating that this is a sample solubility effect due to the compounds' lipophilic nature.

Although increasing the %ACN in the water sample helped the response of certain PPCPs, it caused a significant decrease in response in others if the percentage was too high (Figure 5). This effect, observed for ciprofloxacin, trimethoprim, fluoroquinolones, and sulfa drugs, was attributed to a loss of compound retention on the trapping column, where compounds have a greater affinity for the solvent than the trapping column stationary phase. This effect is similar to compound "break-through" on an SPE cartridge. No fall-off in MS response was observed with a 5  $\mu$ L injection onto the analytical column.

The effect of decreased analyte retention with increasing %ACN in the water sample was also observed with cotinine using a 5  $\mu$ L injection on the analytical C18 column. As Figure 6 shows, the LC peak splitting for cotinine was readily observed in acidic (red) and neutral (green) water samples. However, at pH 11.3, the cotinine peak was virtually unchanged, even at 20% ACN. This is likely due to the fact that the basic compound cotinine is uncharged at pH 11.3, which increases its affinity for the C18 stationary phase.

As seen with cotinine, the biggest challenge in developing an EQUan method for PPCPs was the small, highly-

polar organic compounds. Different trapping columns and mobile phases were tested, but as expected, compromises had to be made to allow the largest breadth of PPCPs in one LC-MS/MS run. Metformin was the clearest example. Despite many approaches, no satisfactory reverse-phase LC method could be discovered because of its very high polarity. Hence, as described in EPA Method 1694, hydrophilic interaction liquid chromatography (HILIC) was used for the successful LC separation of metformin in water. Again, pH had a dramatic effect on the response of metformin (and other Group 4 PPCPs). The best response for metformin was with the water sample adjusted to pH 11.3 prior to injection on the reverse-phase EQUan trapping column.

### EQUan Method Summary

Despite all of the challenges in the development of one single LC/MS method for this diverse group of components, a balance was found that allowed the measurement of the 67 PPCPs in water by the EQUan system, with a large majority being quantified at or below 10 ng/L using a 0.5 mL injection volume with detection on the TSQ Vantage mass spectrometer.

The best compromise for the online sample preparation method was to run an acidified and a basified water sample containing 10% ACN. Figure 7 shows example chromatograms for the PPCPs in water at the ng/L level using this approach. The red chromatograms were the water samples at pH 2.9, and the blue chromatograms were the water samples at pH 11.3. In general, basic conditions were preferable for analyzing the smaller, more polar compounds, and acidic conditions were preferable for analyzing the larger, more lipophilic compounds.



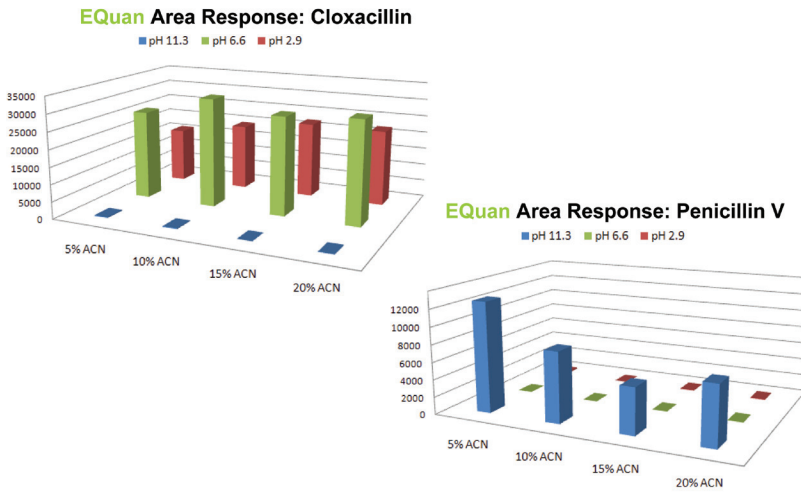

Figure 3. Area response plots demonstrating the pH effect on the sample solubility.

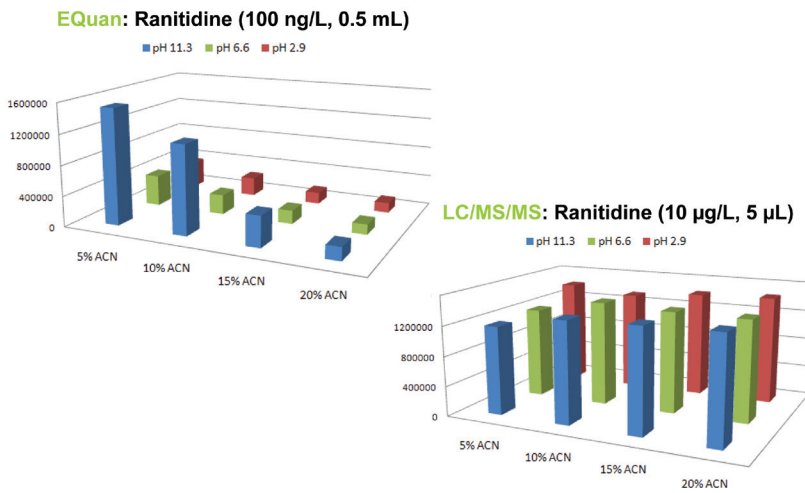

Figure 4. Area response plots for ranitidine demonstrating the pH effect on the preconcentration column.

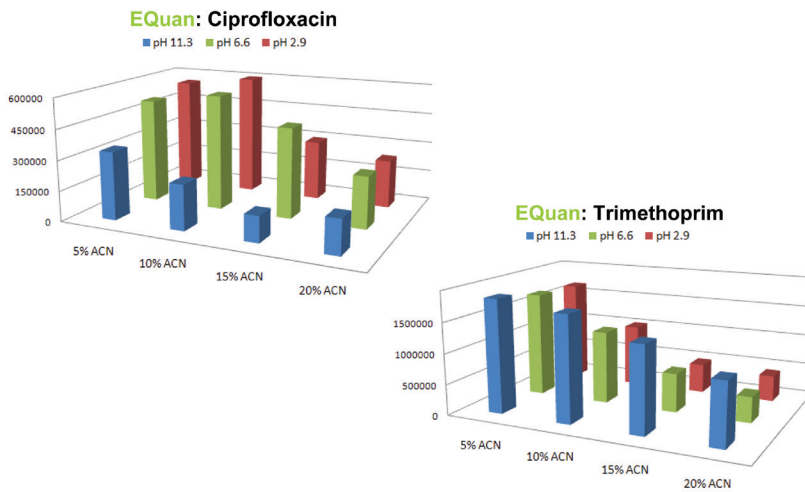

Figure 5. Area response plots showing effect of decreased retention with increasing %ACN.



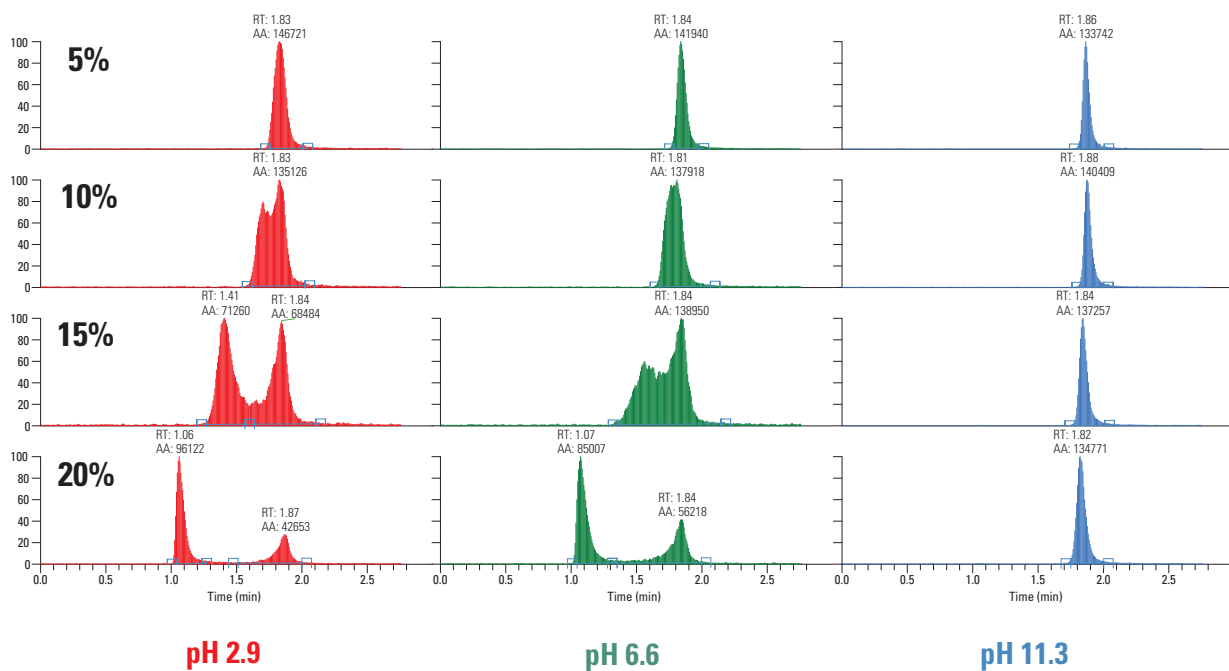

Figure 6. Chromatograms showing the %ACN effect on LC column retention for cotinine.

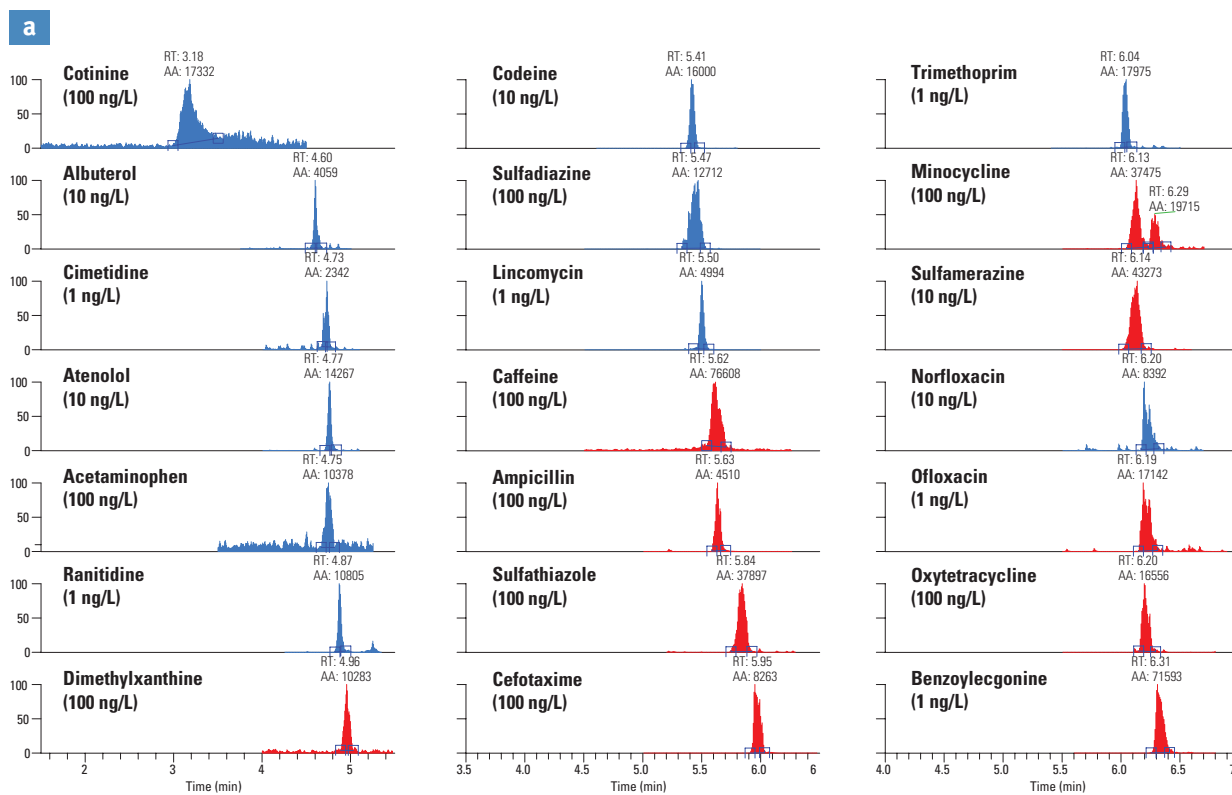

Figure 7 (a,b,c). Example chromatograms of the PPCPs in water at the ng/L level. The LLOQ for each compound is listed in parentheses.

**b**

Figure 7. Example chromatograms of the PPCPs in water at the ng/L level. The LLOQ for each compound is listed in parentheses. (continued)

**c**

Figure 7. Example chromatograms of the PPCPs in water at the ng/L level. The LLOQ for each compound is listed in parentheses. (continued)

## Conclusion

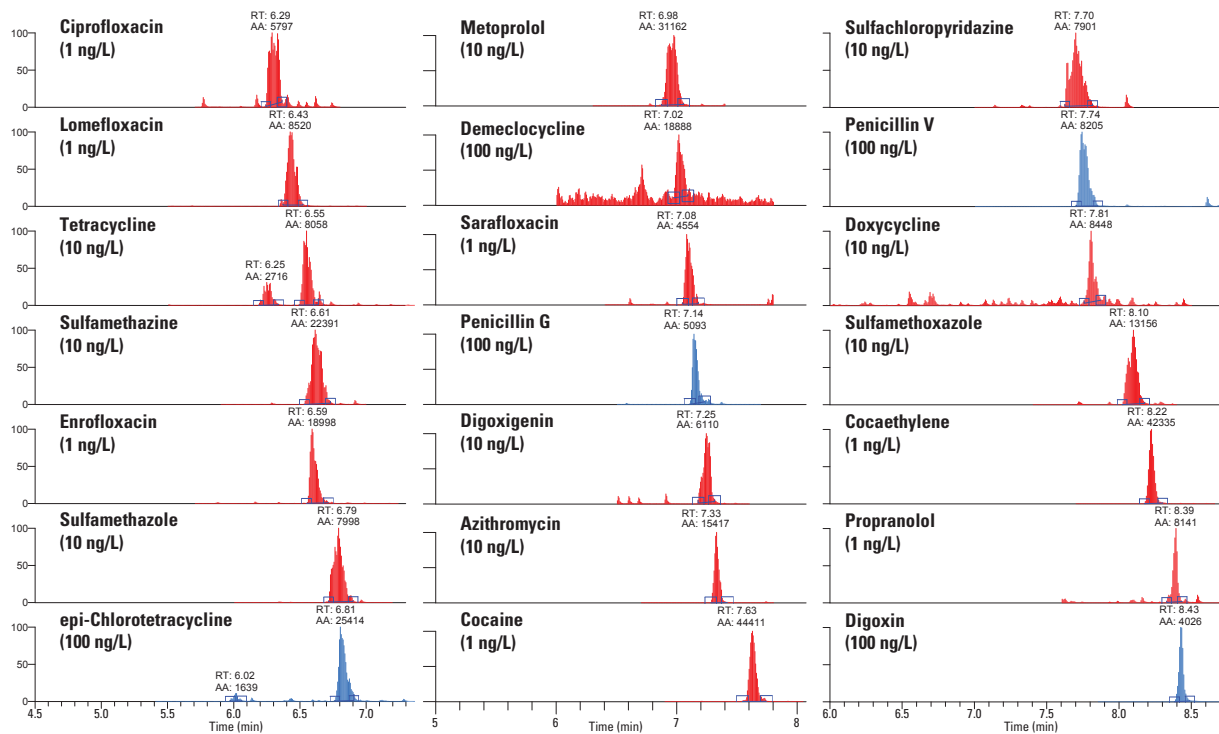
The current EPA Method 1694 describes three different LC methods for PPCPs from Groups 1, 2, and 4, which are amenable to positive ESI-MS/MS. To simplify the method and reduce total analysis time, a single 10-minute LC-MS/MS method was developed on the EQuan system including compounds from additional pharmaceutical classes not included in the EPA method, such as beta-blockers and benzodiazepines.

The EQuan system significantly reduced sample preparation and analysis time while providing quantification of PPCPs in water at low ng/L levels. Online sample preparation of the water samples eliminated the need to use two different offline SPE methods on 1 L of water. This reduced the total analysis time from hours to minutes. The sensitivity of the TSQ Vantage mass spectrometer, using time-dependent SRMs to maximize detector duty cycle, provided low- or sub-ng/L limits of quantitation for the targeted PPCPs in water.

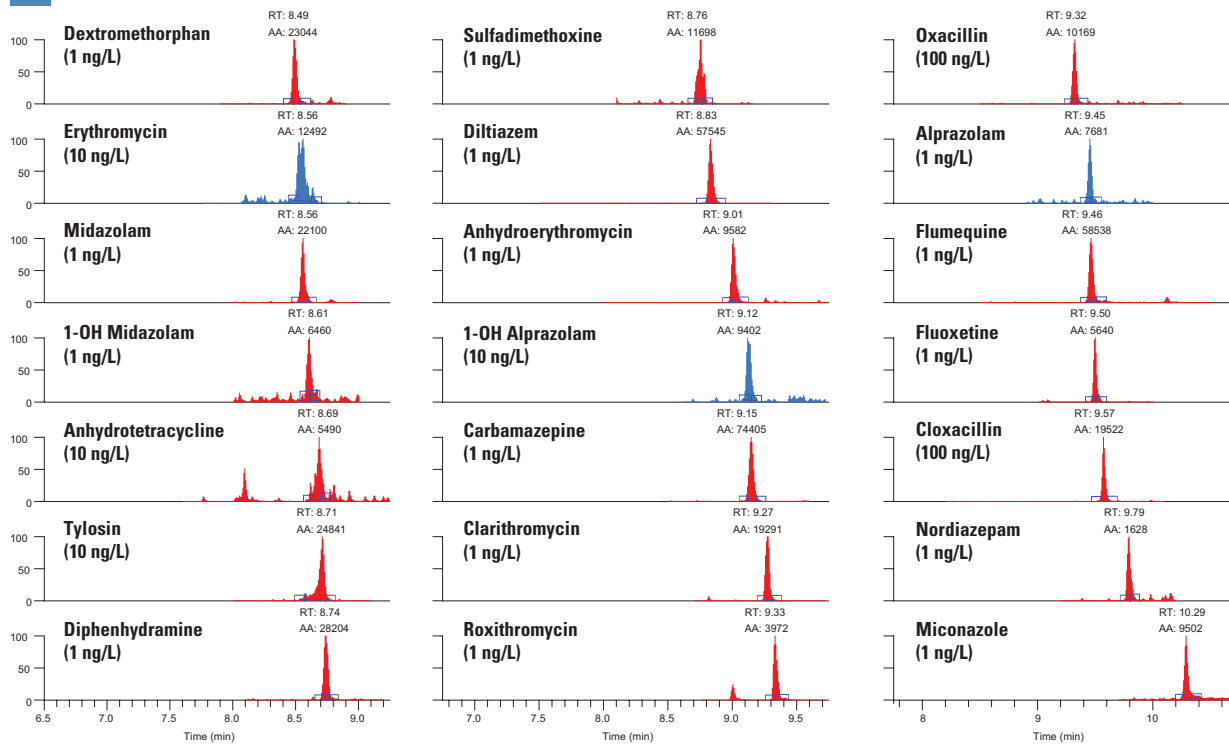
## References

1. EPA Method 1694: Pharmaceuticals and personal care products in water, soil, sediment, and biosolids by HPLC/MS/MS, December 2007, EPA-821-R-08-002.
2. Loftin, K.A.; Adams, C.D.; Meyer, M.T.; Surampalli, R. "Effects of Ionic Strength, Temperature, and pH on Degradation of Selected Antibiotic" *J. Environ. Qual.*, 2008, 37, 378-386.

*In addition to these offices, Thermo Fisher Scientific maintains a network of representative organizations throughout the world.*

**Africa-Other**  
+27 11 570 1840  
**Australia**  
+61 3 9757 4300  
**Austria**  
+43 1 333 50 34 0  
**Belgium**  
+32 53 73 42 41  
**Canada**  
+1 800 530 8447  
**China**  
+86 10 8419 3588  
**Denmark**  
+45 70 23 62 60  
**Europe-Other**  
+43 1 333 50 34 0  
**Finland/Norway/  
Sweden**  
+46 8 556 468 00  
**France**  
+33 1 60 92 48 00  
**Germany**  
+49 6103 408 1014  
**India**  
+91 22 6742 9434  
**Italy**  
+39 02 950 591  
**Japan**  
+81 45 453 9100  
**Latin America**  
+1 561 688 8700  
**Middle East**  
+43 1 333 50 34 0  
**Netherlands**  
+31 76 579 55 55  
**New Zealand**  
+64 9 980 6700  
**Russia/CIS**  
+43 1 333 50 34 0  
**South Africa**  
+27 11 570 1840  
**Spain**  
+34 914 845 965  
**Switzerland**  
+41 61 716 77 00  
**UK**  
+44 1442 233555  
**USA**  
+1 800 532 4752

[www.thermofisher.com](http://www.thermofisher.com)

*Legal Notices: ©2016 Thermo Fisher Scientific Inc. All rights reserved. All trademarks are the property of Thermo Fisher Scientific Inc. and its subsidiaries. This information is presented as an example of the capabilities of Thermo Fisher Scientific Inc. products. It is not intended to encourage use of these products in any manners that might infringe the intellectual property rights of others. Specifications, terms and pricing are subject to change. Not all products are available in all countries. Please consult your local sales representative for details.*

AN63352\_E 08/16S

# LC-MS/MS Analysis of Anti-Infectives In Raw and Treated Sewage

P.A. Segura<sup>1</sup>, A. Garcia Ac<sup>1</sup>, A. Lajeunesse<sup>2</sup>, D. Ghosh<sup>3</sup>, C. Gagnon<sup>2</sup> and S. Sauvé<sup>1</sup>

<sup>1</sup> Département de Chimie, Université de Montréal, C.P. 6128, succursale Centre-ville, Montréal, QC, Canada H3C 3J7

<sup>2</sup> Centre Saint-Laurent, Environnement Canada, 105, rue McGill, Montréal, QC, Canada H2Y 2E7

<sup>3</sup> Thermo Fisher Scientific, San Jose, CA, USA

## Introduction

“Anti-infectives” is a general term that refers to several classes of biologically active compounds used to treat or prevent infections. Therapeutic agents such as antimicrobials (synthetic) and antibiotics (natural or semi-natural) are examples of anti-infectives.

The widespread utilization of anti-infectives in urban centers as well as their resistance to biodegradation or elimination in wastewater treatment plants (WWTPs) has led to their appearance in effluents and surface waters<sup>[1-3]</sup>. In the last few years there has been a growing concern about the environmental fate and the possible effects of these agents on the aquatic environment<sup>[4,5]</sup>.

The first report on the occurrence of anti-infective traces in the aquatic environment was published as early as 1983<sup>[6]</sup>. A later study<sup>[7]</sup> acknowledged that pharmaceuticals would enter the water cycle mainly via a “domestic route” (*i.e.* by the excreta of individuals taking medication at homes, hospitals or clinics). It is therefore important to know the amounts of these substances released in the aquatic environment to be able to evaluate potential effects.

A sensitive and robust method was developed for the determination of some of the most prescribed anti-infectives in trace amounts (lower nanogram-per-liter range) in raw and treated wastewaters.

## Goals

- Quantify several anti-infectives at the lower nanogram-per-liter level in raw and treated wastewaters.
- Apply two specific single reaction monitoring mode (SRM) transitions and their peak ratio to avoid the presence of false positives.

## Method

Raw sewage (north and south influent) was collected and treated (effluent) 24-h composite samples at the municipal wastewater treatment plant of the City of Montréal (Québec, Canada). This plant has physico-chemical treatments only and its effluent is one of the largest in North America. We analyzed six of the most prescribed compounds (sulfamethoxazole, trimethoprim, ciprofloxacin, levofloxacin, clarithromycin and azithromycin) (Figure 1), by using solid phase extraction (SPE) and liquid chromatography-tandem mass spectrometry (LC-MS/MS). The compounds were selected based on drugstore sales.

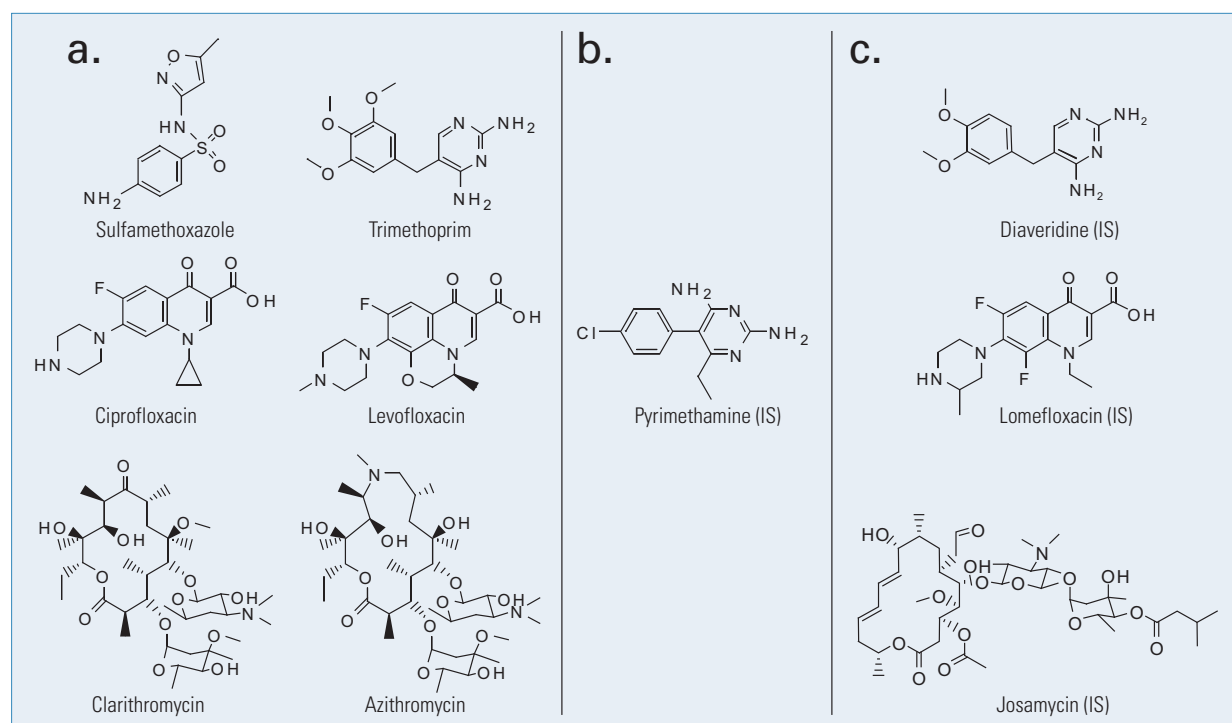

Figure 1: Molecular structures of the anti-infectives studied (a), the surrogate standard (b), and the internal standards (c).

## Key Words

- TSQ Quantum Ultra™
- Surveyor HPLC™
- Antibiotics
- SPE

## Sample Preparation

Wastewater samples were filtered using 1.2 µm pore-size fiber glass filters and then 0.45 µm pore-size mixed cellulose membranes. 50 mM of formic acid and 1 mL of a 5% Na<sub>2</sub>EDTA (w/v) solution were added to 250 mL of wastewater and the pH adjusted to 3 with NaOH 1.0 M. Pyrimethamine was used as a surrogate standard and spiked at a concentration of 500 ng L<sup>-1</sup>.

Analytes were pre-concentrated and extracted using a 200 mg reversed phase polymeric SPE cartridge on top of a 200 mg mixed mode polymeric SPE cartridge. Retained analytes were eluted from the cartridges using 2 × 2.5 mL ACN: MeOH 1:1 (reversed phase) and 2 × 2.5 mL 5% NH<sub>3</sub> in ACN: MeOH 1:1 (mixed mode). The eluates were recovered from both cartridges and were collected on the same conical-bottom centrifuge tube and then evaporated to dryness with N<sub>2</sub>(g). Extracted analytes were reconstituted to 250 µL with 0.1% formic acid in 90% H<sub>2</sub>O/5% MeOH/5% ACN solution containing the internal standards (diaveridine, lomefloxacin and josamycin).

## LC-MS/MS Conditions

HPLC separation was done with a Thermo Scientific Surveyor HPLC system. Detection and quantification of the analytes was performed with a Thermo Scientific TSQ Quantum Ultra using the single reaction monitoring mode (SRM) (Table 1). Two specific single reaction monitoring (SRM) transitions were used for each compound as well as their peak area ratios to reliably confirm the presence of the targeted anti-infectives. This reduced the possibility of false positives given that some interfering matrix components are co-extracted with the analytes and could have the same SRM transition.<sup>[8]</sup>

## Results and Discussion

MS/MS in the SRM mode proved to be highly selective. Instrument response was linear ( $r^2 \geq 0.99$ ) in the dynamic range (25–1000 ng L<sup>-1</sup>) in spite of the presence of high concentrations of organic as well as inorganic interferences in the matrix. Limits of detection ranged from

**Table 1: Instrument Parameters**

HPLC		MS	
Column	Thermo Scientific BetaBasic™ C18 (50 × 2.1 mm, 3 µm)	Ionization mode	ESI+
Column temperature	30°C	Spray voltage	3500 V
Mobile phase A	0.1 % formic acid/H <sub>2</sub> O	Ion transfer capillary temperature	350 °C
Mobile phase B	0.1% formic acid/MeOH:ACN 1:1	Sheath gas pressure	21 mTorr
Injection volume	20 µL	Auxiliary gas pressure	4 mTorr
Flow rate	200 µLmin <sup>-1</sup>	Collision gas pressure	1.5 mTorr
Gradient	t=0 min, A=90%, B=10% t=2 min, A=80%, B=20% t=15 min, A=75%, B=25% t=17 min, A=50%, B=50% t=20 min, A=5%, B=95% t=25 min, A=5%, B=95% t=30 min, A=90%, B=10%	Source CID	-12 V

**Table 2: SRM transitions used for detection and quantification (SRM #1) and confirmation (SRM #2)**

Compound	SRM #1		CE (V)	SRM #2		CE (V)	Tube Lens
Pyrimethamine	249.10	177.07	40				
Sulfamethoxazole <sup>†</sup>	254.08	92.11	36	254.08	108.10	37	70
Diaveridine	261.15	123.11	34				
Trimethoprim <sup>†</sup>	291.16	123.10	33	291.16	230.17	34	91
Ciprofloxacin <sup>†</sup>	332.16	231.07	49	332.16	288.15	27	82
Lomefloxacin	352.17	265.13	34				
Levofloxacin <sup>†</sup>	362.17	261.12	35	362.17	221.05	43	92
Clarithromycin <sup>*</sup>	748.55	590.36	19	748.55	115.99	35	96
Azithromycin <sup>*</sup>	375.33	82.96	25	749.54	158.04	38	74/112
Josamycin	828.53	108.87	46	828.53	173.96	47	126

<sup>†</sup>Quantified using diaveridine as the internal standard, <sup>‡</sup>Quantified using lomefloxacin as the internal standard, <sup>\*</sup>Quantified using josamycin as the internal standard

**Table 3: Analytical method parameters**

Compound	r <sup>2</sup> matrix*	Limit of Detection (ngL <sup>-1</sup> )	Standard SRM ratio±SD <sup>†</sup>	Sample SRM ratio±SD <sup>‡</sup>	SRM ratio difference <sup>^</sup>
Sulfamethoxazole	0.9995	22	1.53 ± 0.03	1.6 ± 0.2	-2.6
Trimethoprim	0.9998	7	4.2 ± 0.1	4.39 ± 0.07	-3.3
Ciprofloxacin	0.9996	21	5.5 ± 0.8	6.59 ± 0.05	-18.9
Levofloxacin	0.9996	4	3.65 ± 0.07	3.83 ± 0.06	-5.0
Clarithromycin	0.9997	0.3	1.67 ± 0.04	1.59 ± 0.09	4.3
Azithromycin	0.9900	12	1.2 ± 0.1	0.44 ± 0.1	6.4

\*Determination coefficient of the calibration curve made using the WWTP effluent diluted by a factor of 10; \*\*Calculated from the effluent data based on a S/N=3; <sup>†</sup>Standards spiked WWTP effluent diluted by a factor of 10, n=4; <sup>‡</sup>WWTP effluent, n=3; <sup>^</sup>Percentage difference between the standard and sample SRM ratio.

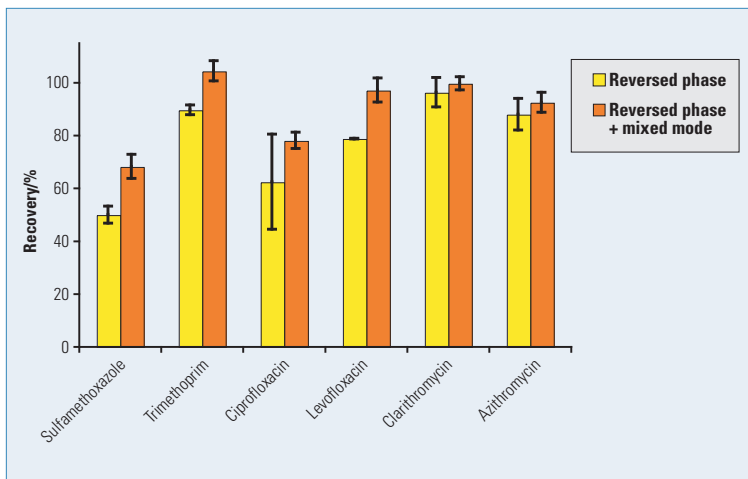
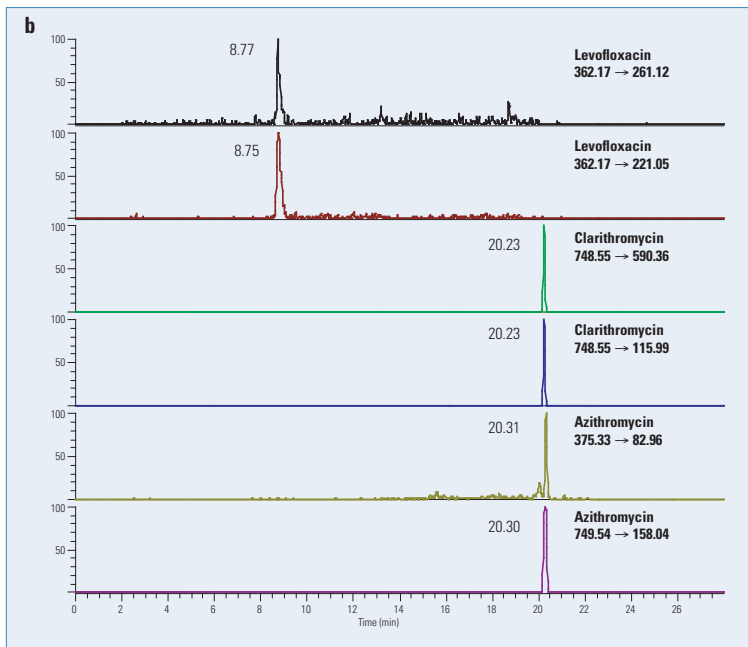
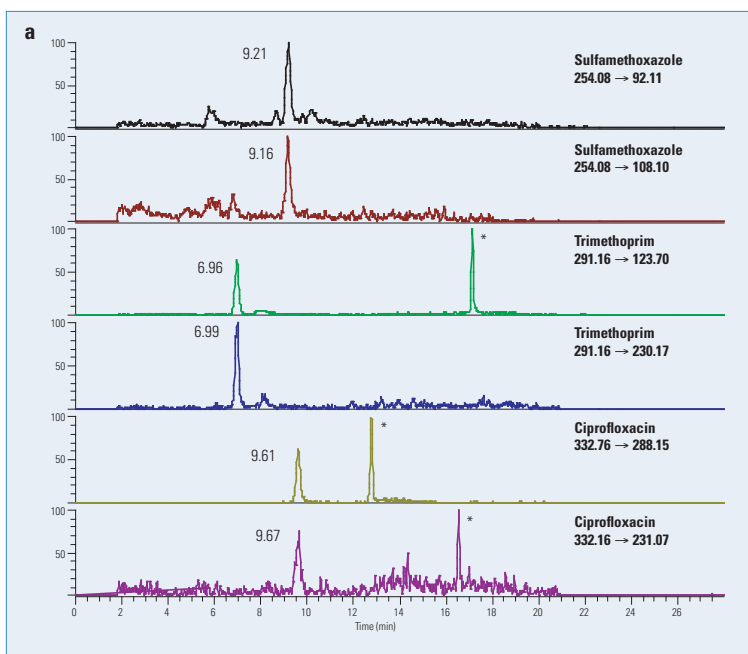

Figure 2: Analytes mean percentage recovery (spiked in the effluent at 500 ng L<sup>-1</sup>, n=2)



0.3 to 22 ng L<sup>-1</sup> (Table 3). As suggested by Hernandez<sup>[8]</sup>, the use of two SRM transitions in the analytical method (Figure 3) as well as their peak ratios effectively and unambiguously confirmed the presence of the studied anti-infectives in all the samples. SRM peak ratios were reproducible (RSD <10%) and differences with SRM peak ratios of spiked standards were not higher than 20% except for AZI (64%).

The tandem-SPE approach utilized to pre-concentrate and extract the analytes from untreated and treated sewage improved the recovery on all six analytes (Figure 2).

The combination of reversed-phase and ion-exchange surface chemistry proved to be a suitable way to extract compounds having different chemical properties such as pK<sub>a</sub> and pK<sub>ow</sub>.

All targeted anti-infectives were found in the wastewater samples in concentrations ranging from 39 ± 1 to 276 ± 7 ng L<sup>-1</sup> (Figure 4).

Anti-infective daily mass flows in the St. Lawrence River were estimated using the flow of the sampling day (35 m<sup>3</sup> s<sup>-1</sup>) (Table 4). These results show that while anti-infective concentration in urban wastewaters are typically in the low nanogram-per-liter range, their daily discharged inputs in surface waters can be substantial.

Figures 3a-b: Chromatograms showing two SRM transitions of the studied compounds in treated wastewater. Peaks due to interferences are marked by asterisks(\*).

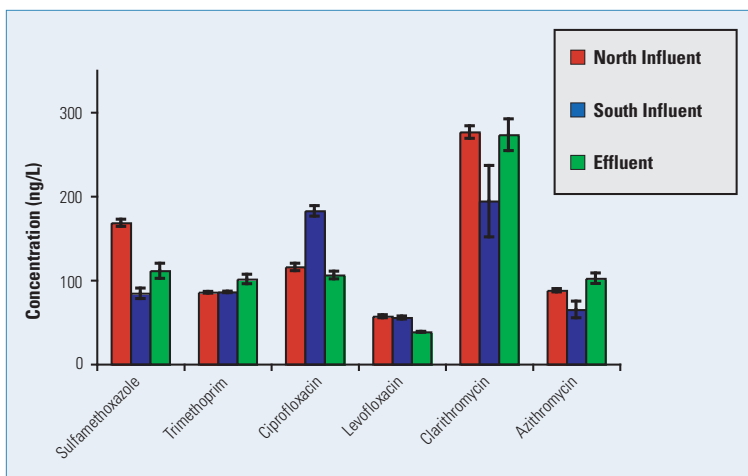

Figure 4: Occurrence of the studied anti-infectives in the dissolved phase of raw and treated sewage of the City of Montréal (n=3)

**Table 4: Removal efficiency of the Montréal wastewater treatment plant and average mass flow of the studied anti-infectives.**

Compound	Mean mass flow in the St. Lawrence River (g day <sup>-1</sup> )
Sulfamethoxazole	340 ± 30
Trimethoprim	310 ± 20
Ciprofloxacin	320 ± 10
Levofloxacin	118 ± 2
Clarithromycin	830 ± 60
Azithromycin	310 ± 20

## Conclusions

The developed analytical method allowed the extraction, detection and quantification of six of the most used anti-infectives in untreated and treated sewage. Detection limits ranged from 0.3 to 22 ng L<sup>-1</sup> and instrument response was linear ( $r^2 \geq 0.99$ ) in the dynamic range (25–1000 ng L<sup>-1</sup>). The use of two specific SRM transitions and their peak area ratios proved to be a reliable and effective way to reduce false positives and confirm the presence of targeted substances. All the studied anti-infectives were found in the wastewater samples in concentrations ranging from 39 to 276 ng L<sup>-1</sup>. More studies are necessary to elucidate the fate of these anti-infectives after they are discharged into the St. Lawrence River as well as their effects on aquatic biota and the environment.

## Legal Notices

©2016 Thermo Fisher Scientific Inc. All rights reserved. All trademarks are the property of Thermo Fisher Scientific Inc. and its subsidiaries. This information is presented as an example of the capabilities of Thermo Fisher Scientific Inc. products. It is not intended to encourage use of these products in any manners that might infringe the intellectual property rights of others. Specifications, terms and pricing are subject to change. Not all products are available in all countries. Please consult your local sales representative for details.

## References

- Kolpin D.W., Furlong E.T., Meyer M.T., Thurman E.M., Zaugg S.D., Barber L.B., and Buxton H.T. (2002) *Environmental Science & Technology* 36:1202-1211.
- Hirsch R., Ternes T., Haberer K., and Kratz K.L. (1999) *Science of the Total Environment* 225:109-118.
- Metcalf C.D., Koenig B.G., Bennie D.T., Servos M., Ternes T.A., and Hirsch R. (2003) *Environmental Toxicology & Chemistry* 22:2872-2880.
- Wilson B.A., Smith V.H., Denoyelles F., and Larive C.K. (2003) *Environmental Science & Technology* 37:1713-1719.
- Richards S.M., Wilson C.J., Johnson D.J., Castle D.M., Lam M., Mabury S.A., Sibley P.K., and Solomon K.R. (2004) *Environmental Toxicology and Chemistry* 23:1035-1042.
- Watts CD, Crathorne B, Fielding M, and Steel CP (1983) *Analysis of Organic Micropollutants in Water*. D. Reidel Publishing Company, Dordrecht.
- Richardson M.L. and Bowron J.M. (1985) *Journal of Pharmacy & Pharmacology* 37:1-12.
- Hernandez E, Ibanez M., Sancho J.V., and Pozo S.J. (2004) *Analytical Chemistry* 76:4349-4357.

In addition to these offices, Thermo Fisher Scientific maintains a network of representative organizations throughout the world.

**Africa**  
+43 1 333 5034 127

**Australia**  
+61 2 8844 9500

**Austria**  
+43 1 333 50340

**Belgium**  
+32 2 482 30 30

**Canada**  
+1 800 530 8447

**China**  
+86 10 5850 3588

**Denmark**  
+45 70 23 62 60

**Europe-Other**  
+43 1 333 5034 127

**France**  
+33 1 60 92 48 00

**Germany**  
+49 6103 408 1014

**India**  
+91 22 6742 9434

**Italy**  
+39 02 950 591

**Japan**  
+81 45 453 9100

**Latin America**  
+1 608 276 5659

**Middle East**  
+43 1 333 5034 127

**Netherlands**  
+31 76 587 98 88

**South Africa**  
+27 11 570 1840

**Spain**  
+34 914 845 965

**Sweden/Norway/Finland**  
+46 8 556 468 00

**Switzerland**  
+41 61 48784 00

**UK**  
+44 1442 233555

**USA**  
+1 800 532 4752

[www.thermo.com](http://www.thermo.com)

AN62489\_E 08/16S

View additional Thermo Scientific LC/MS application notes at: [www.thermo.com/appnotes](http://www.thermo.com/appnotes)



# Optimizing a Generic Approach to Analyzing PPCPs in River Water

*Kelly Munro,<sup>1</sup> Anthony Edge,<sup>2</sup> Claudia Martins,<sup>3</sup> David Cowan<sup>4</sup> and Leon Barron<sup>1</sup>*

*<sup>1</sup>Analytical & Environmental Sciences Division, King's College London, UK,*

*<sup>2</sup>Thermo Fisher Scientific, Runcorn, UK, <sup>3</sup>Thermo Fisher Scientific, Villebon, France*

*<sup>4</sup>Drug Control Centre, King's College London, UK*



## Introduction

The occurrence of pharmaceutically-related contaminants within the environment continues to be a research area which generates great interest. The full environmental effects of chronic exposure of such pollutants have yet to be fully understood. As such more knowledge is sought on the presence of these contaminants within the environment.

Traditionally, a targeted multi-residue analytical approach is applied to the analysis of environmental waters. A consequence of this can be a somewhat limited estimation of the true breadth of occurrence of pharmaceutically-related drug residues within such waters. Recent advances have seen non-targeted methods proposed as valid alternatives to the traditional approach.

A 'semi-targeted' analytical approach is presented herein for the detection of a range of over-the-counter, prescribed and illicit drugs in environmental waters using mixed mode solid phase extraction (SPE) and liquid chromatography-high resolution mass spectrometry (LC-HRMS). The potential to perform retrospective non-target analysis is also presented.

## Experimental

A broad analytical screening method, shown in Figure 1, was developed using a selection of structurally diverse species which represented a variety of compounds classes, functional groups,  $pK_a$  and  $\log P$  values as well as reported environmental occurrences.

**FIGURE 1. Schematic showing developed semi-targeted analytical approach.**

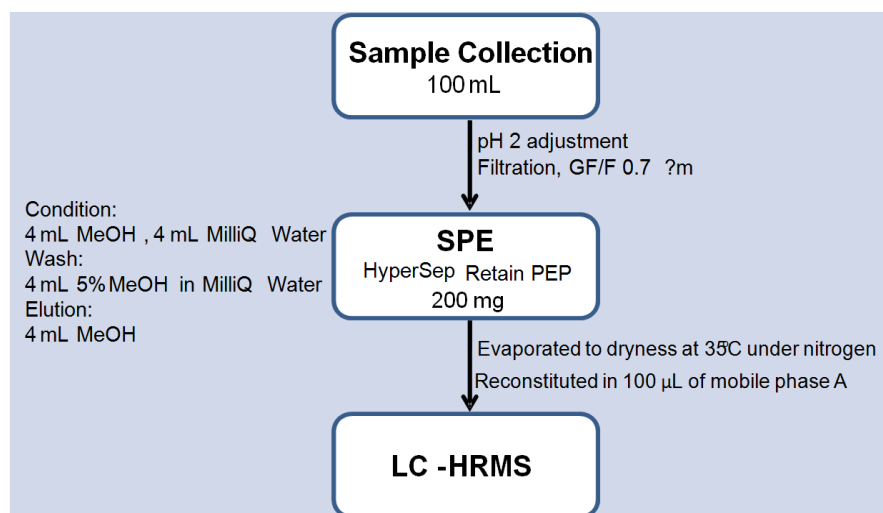

LC-HRMS was performed using a Thermo Scientific™ QExactive™ system (Thermo Scientific, Bremen, Germany), and the chromatographic and MS conditions are detailed in Table 1.

**TABLE 1. Chromatographic and MS experimental conditions.**

	Column	Thermo Scientific™ Accucore™ C18 2.6µm, 150 x 2.1 mm	
LC	Mobile Phase	A: 90:10 Aqueous 10mM Ammonium Acetate : Acetonitrile B: 20:80 Aqueous 10 mM Ammonium Acetate : Acetonitrile	
	Injection volume	20 µL	
	Flow Rate	400 µL/min	
HRMS	Capillary Temp (°C)	350	
	Heater Temp (°C)	300	
	Spray Voltage	+ve. 4.5 kV	-ve. 3 kV
	Capillary Voltage	+ve. 52.5 V	-ve. 52.5 V
	Tube Lens Voltage	+ve. 135 V	-ve. 135 V
	Resolution	50,000 FWHM	
	Scan Range	m/z: 100-1000	
	AGC Target	1,000,000	
	Max. Inject Time	100 ms	
	Fragmentation Mode	HCD (20eV)	

# Results & Discussion

## 1. SPE Method Development

The recoveries of compounds were evaluated for two different SPE sorbents using different sample volumes. Figure 2 shows that optimized absolute recoveries for the majority of compounds were obtained using the Retain PEP-functionalized polystyrene-divinylbenzene sorbent with a 100 mL sample when adjusted to pH 2.

**FIGURE 2. Absolute recoveries obtained using a PS-DVB sorbent (PEP) and a mixed mode cation exchange sorbent (CX) with a sample adjusted to pH 2.**

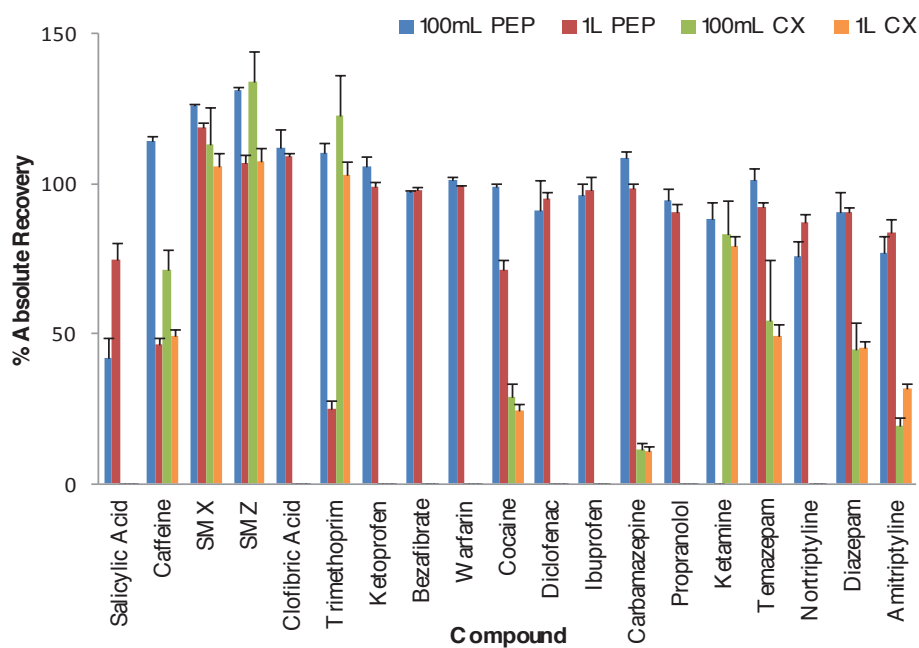

## 2. 'Semi-Targeted' Screening of Real Samples

The developed analytical method was applied to the analysis of both Thames river water and influent wastewater. The presence of an analyte was confirmed by comparison with a reference standard. As an example the presence of cocaine is shown in Figure 3.

**FIGURE 3. Cocaine confirmation.  $t_R$ : retention time; AA: Peak Area; AH: Peak Height; BP: Base Peak accurate mass.**

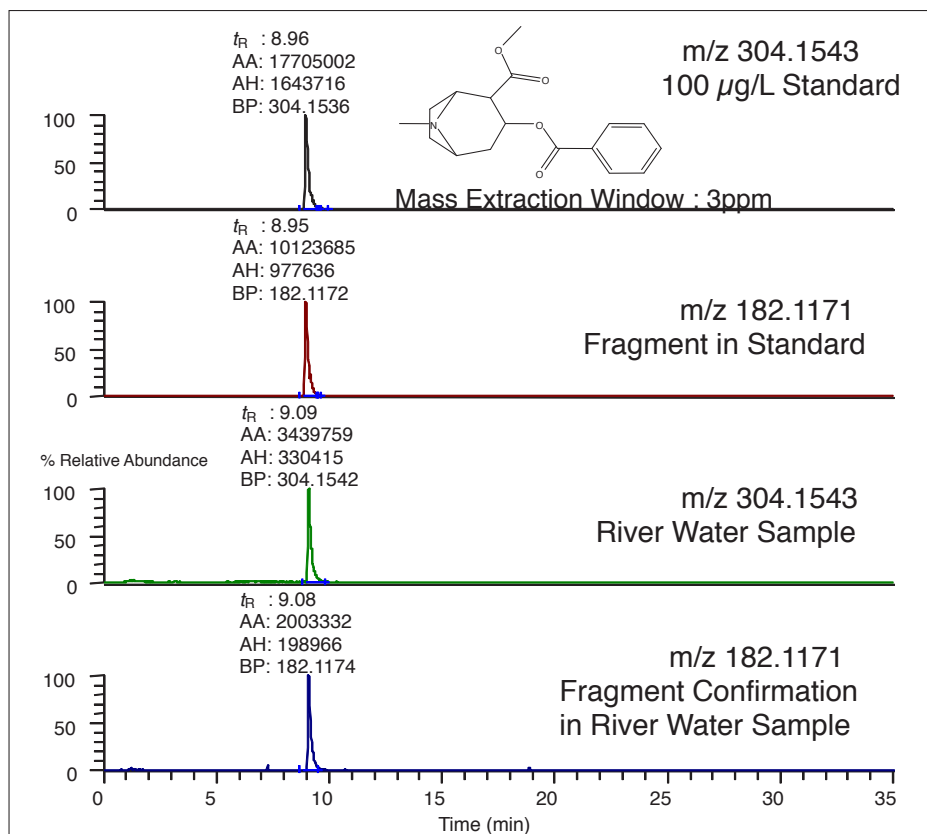

Week-long qualitative studies of both river water and influent showed that the majority of the targeted compounds were present. This is shown in Figures 4 and 5 respectively. A quantitative analysis is now in preparation.

**FIGURE 4. Weekly variation of identified compounds in Thames river water.**

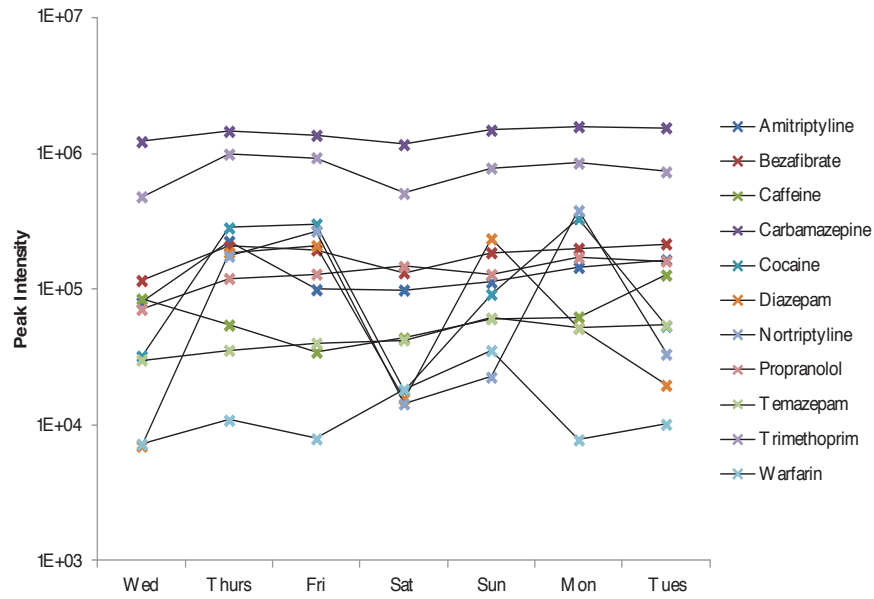

Levels of the majority of compounds remain consistent across the week, with the biggest fluctuations being observed in river water, in particular for cocaine and diazepam. It can also be seen that levels were approximately ten fold higher in influent for several compounds.

**FIGURE 5. Weekly variation of identified compounds in influent wastewater.**

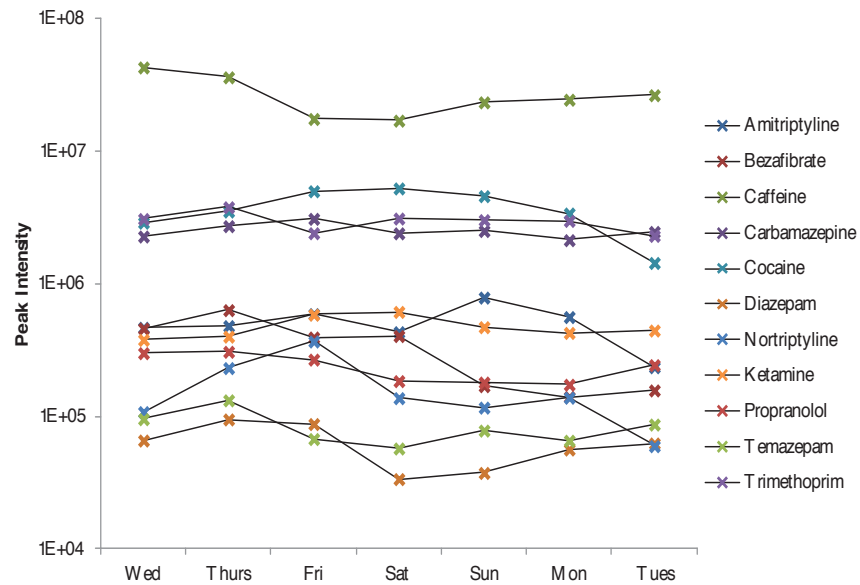

### 3. Mephedrone in the Environment

Using the above approach, it was also possible to identify the illicit drug, mephedrone (4-methylmethcathinone) in both river and wastewater.



**FIGURE 6. Chromatograms indicating the presence of the illicit drug mephedrone within river water and influent wastewater.**

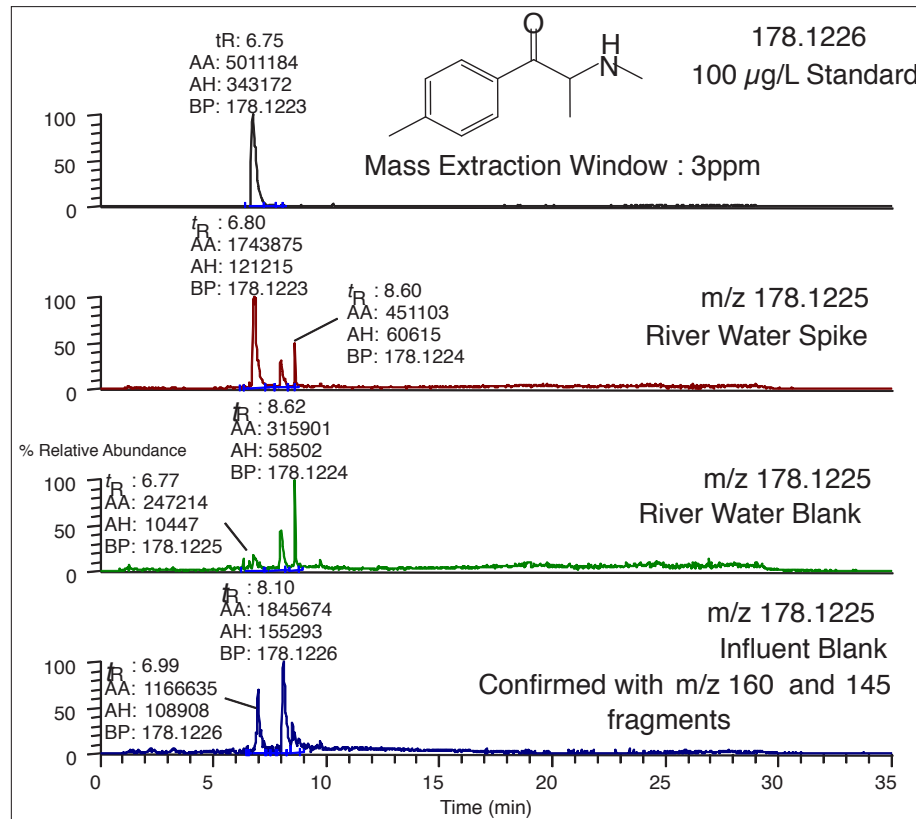

Figure 6 shows the presence of mephedrone in river water, along with an unknown peak at 8.6 min which has the same accurate mass as mephedrone. Comparing a spiked sample with a blank sample it is clear that the intensity of the mephedrone peak increases accordingly whereas the unknown peak stays constant, confirming the presence of mephedrone within the river water. Mephedrone was also detected in influent water, with confirmatory fragment ions (m/z 160.1117 and 145.0883). Again, an unknown peak was present at a similar retention time to that observed in river water. Therefore, this shows that even with HRMS, the optimization of separation conditions is still very important. Ongoing efforts aim to apply this method in a quantitative analysis of both sample types once a complete analyte list is determined based on actual occurrence data.

# Conclusion

A developed 'semi-targeted' analytical method was used to confirm the presence of several medicinal and illicit species in both river water and influent wastewater. The potential of non-target retrospective analysis was also highlighted with the detection of the illegal drug mephedrone within environmental waters.

[www.thermofisher.com](http://www.thermofisher.com)

©2016 Thermo Fisher Scientific Inc. All rights reserved. All trademarks are the property of Thermo Fisher Scientific Inc. and its subsidiaries. This information is presented as an example of the capabilities of Thermo Fisher Scientific products. It is not intended to encourage use of these products in any manners that might infringe the intellectual property rights of others. Specifications, terms and pricing are subject to change. Not all products are available in all countries. Please consult your local sales representative for details.

**Africa** +43 1 333 50 34 0  
**Australia** +61 3 9757 4300  
**Austria** +43 810 282 206  
**Belgium** +32 53 73 42 41  
**Brazil** +55 11 3731 5140  
**Canada** +1 800 530 8447  
**China** 800 810 5118 (free call domestic)  
400 650 5118

**Denmark** +45 70 23 62 60  
**Europe-Other** +43 1 333 50 34 0  
**Finland** +358 9 3291 0200  
**France** +33 1 60 92 48 00  
**Germany** +49 6103 408 1014  
**India** +91 22 6742 9494  
**Italy** +39 02 950 591

**Japan** +81 6 6885 1213  
**Korea** +82 2 3420 8600  
**Latin America** +1 561 688 8700  
**Middle East** +43 1 333 50 34 0  
**Netherlands** +31 76 579 55 55  
**New Zealand** +64 9 980 6700  
**Norway** +46 8 556 468 00

**Russia/CIS** +43 1 333 50 34 0  
**Singapore** +65 6289 1190  
**Sweden** +46 8 556 468 00  
**Switzerland** +41 61 716 77 00  
**Taiwan** +886 2 8751 6655  
**UK/Ireland** +44 1442 233555  
**USA** +1 800 532 4752

**Thermo**  
S C I E N T I F I C

A Thermo Fisher Scientific Brand



# Surface, Drinking and Waste Water Analysis

Polyhalogenated Compounds

# Analysis of Perfluoroalkyl Acids in Wastewater, Sludge, and Liver Extracts Using High-Resolution, Accurate Mass LC-MS

Frans Schoutsen<sup>1</sup>, Helen Welchman<sup>2</sup>, Rossana Bossi<sup>3</sup>; <sup>1</sup>Thermo Fisher Scientific, Breda, The Netherlands; <sup>2</sup>Thermo Fisher Scientific, Hemel Hempstead, United Kingdom; <sup>3</sup>Aarhus University, Roskilde, Denmark

## Introduction

Perfluoroalkyl acids (PFAAs) are global pollutants and have been shown to bioaccumulate in the food chain. PFAAs have been detected in livers of fish, birds, and marine mammals from Greenland and the Faroe Islands.<sup>1</sup> Biomagnification of perfluorooctane sulfonate (PFOS), the predominant fluorochemical detected, was observed along the marine food chain (Figure 1).

The performance of the Thermo Scientific Exactive mass spectrometer equipped with Orbitrap™ technology has been evaluated for the analysis of ten selected perfluoroalkyl acids in pooled extracts from environmental samples. The following PFAAs were analyzed: perfluoroheptanoic acid (PFHpA), perfluorooctanoic acid (PFOA), perfluorononanoic acid (PFNA), perfluorodecanoic acid (PFDA), perfluoroundecanoic acid (PFUnA), perfluorododecanoic acid (PFDoA), perfluorotridecanoate acid (PFTrA), perfluorohexane sulfonate (PFHxS), perfluorooctane sulfonate (PFOS) and perfluorooctane sulfonamide (PFOSA) (Figure 2).

The sample extracts were chosen to represent both high and low levels of the analytes in complex matrices. Low levels were expected in liver extracts from Antarctic seals. Medium and high levels were expected in Arctic seals, influent water, and sludge from a wastewater treatment plant. The performance has been evaluated in terms of linearity (range 0.1-50 µg/kg), specificity, and sensitivity.

## Goal

To demonstrate the performance of the Exactive™ high-resolution, accurate mass benchtop liquid chromatography-mass spectrometry (LC-MS) system in the analysis of ten selected perfluoroalkyl acids.

## Experimental Conditions

### Sample Preparation

The sample preparation process is illustrated in Figure 3. Liver samples were extracted by ion pairing with tetrabutylammonium hydrogen sulfate (TBAS) and methyl tertiary butyl ether (MTBE). Sludge samples were extracted by sonication with methanol followed by solid phase extraction (SPE). Effluent water samples were extracted by SPE on C18 columns.

### HPLC

Chromatographic analysis was performed using a Thermo Scientific Accela autosampler and pump. The chromatography conditions were as follows:

HPLC column:	Thermo Scientific Hypersil GOLD, 50 mm x 2.1 mm, 1.9 µm
Pre-column:	Thermo Scientific Hypercarb, 100 mm x 2.1 mm, 5 µm
Column temperature:	40 °C
Mobile phase C:	Ammonium acetate (2 mM)
Mobile phase D:	90% water, 10% ammonium acetate

A trapping column placed in line with the Accela™ pump and autosampler enabled less contamination of perfluorinated compounds (PFC) into the system, thus achieving a lower background.

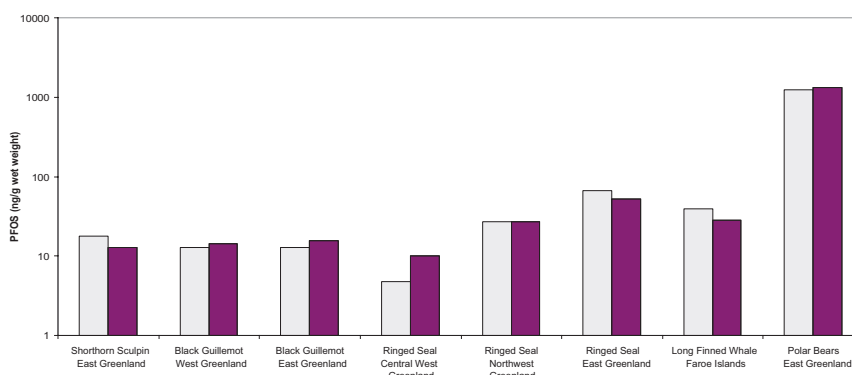

Figure 1. PFOS concentrations (analysis of two samples) in Arctic mammals, birds, and fish [Bossi et al. (2005)]

## Key Words

- Exactive
- Orbitrap technology
- Environmental application
- PFAAs
- PFOS

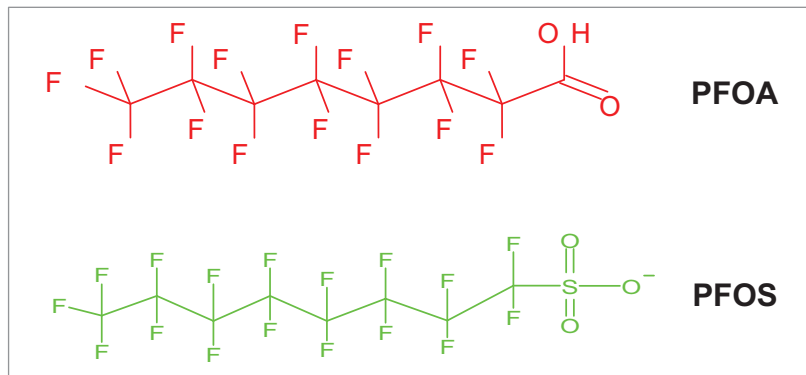

Figure 2. Examples of PFAA target compounds – PFOA and PFOS

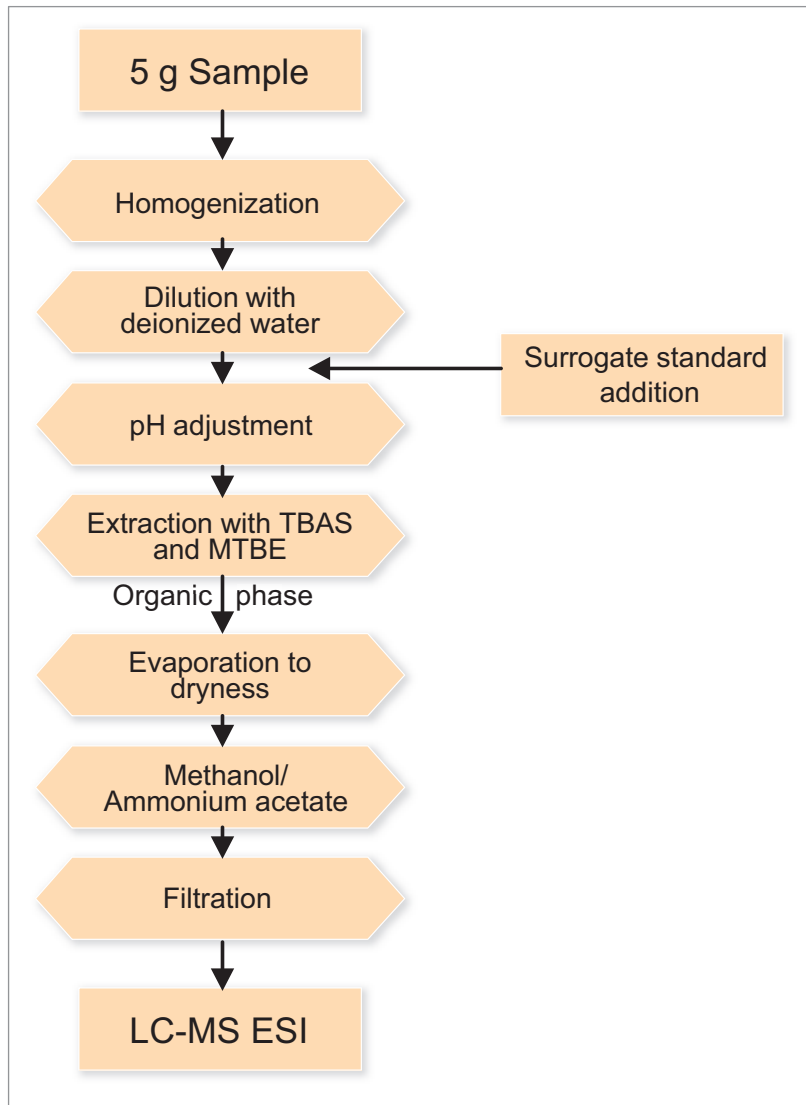

Figure 3. Sample preparation process

## Mass Spectrometry

MS analysis was carried out on an Exactive high performance benchtop LC-MS with an electrospray ionization (ESI) source in negative ion mode. Full scan data with a resolution of 50,000 FWHM at  $m/z$  200-800 was acquired. No lock mass was applied.

## Results and Discussion

The high mass resolution (50,000 FWHM) and mass accuracy (1 ppm) of the Exactive high-resolution, accurate mass system provide efficient peak confirmation and decrease the effects of matrix peaks (Figure 4). The concentration of the target compound in the liver samples was quantified by linear calibration. The use of lock masses could enhance the mass accuracy; however, the Orbitrap instrument was stable for the duration of the sample analysis.

In Figure 5, the extracted ion chromatograms, normalized to the response, are shown. The blank (a) shows very little background and no significant signal at the appropriate retention time. The 0.1  $\mu\text{g}/\text{kg}$  standard (b) has good signal for all compounds, as does the sample of extracted Arctic seal liver (c).

For the calibration curves, three standards per level (0.1, 1, 5, 10, and 50  $\mu\text{g}/\text{kg}$ ) were run. The calibration curve for PFOA is shown in Figure 6.

The results of the analysis are displayed in Table 1. The extracted liver from Antarctic seals showed significantly lower concentrations of PFAAs than the extracted liver from Arctic seals.

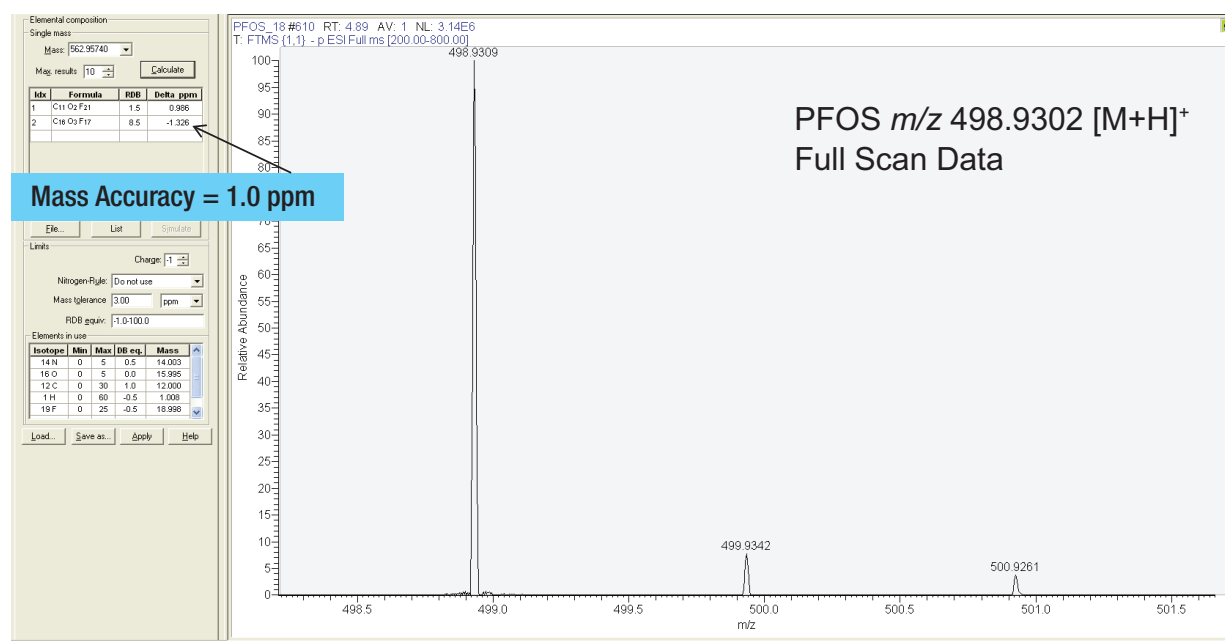
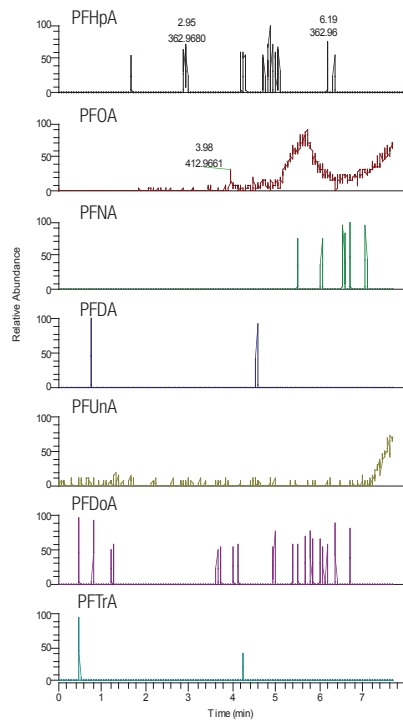

Figure 4. Mass accuracy of PFOS

Table 1. PFAAs in Antarctic and Arctic seal liver

	Antarctic Seal $\mu\text{g}/\text{kg}$	Arctic Seal $\mu\text{g}/\text{kg}$	Arctic Seal $\mu\text{g}/\text{kg}$	Arctic Seal $\mu\text{g}/\text{kg}$
PFHpA	–	–	0.08	1.05
PFHxS	–	0.21	–	0.21
PFOA	0.25	0.35	2.28	4.37
PFNA	0.07	4.78	1.72	1.76
PFOS	–	22.95	17.79	2.28
PFDA	–	2.82	12.59	1.09
PFOSA	–	0.14	–	–
PFUnA	–	5.45	0.44	–
PFDoA	0.22	0.87	–	–
PFTra	–	1.97	–	–

a) Blank



b) Standard

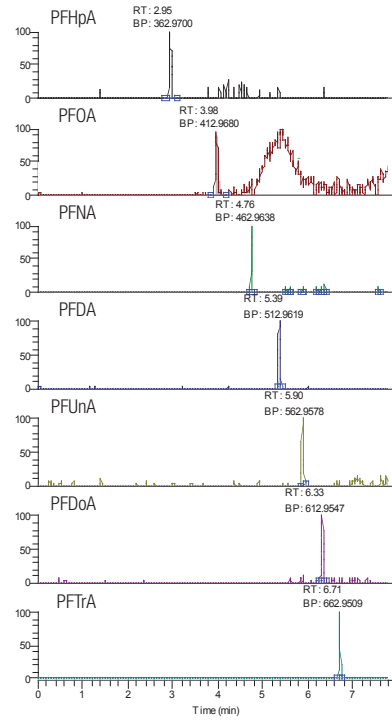

c) Arctic Seal Extract

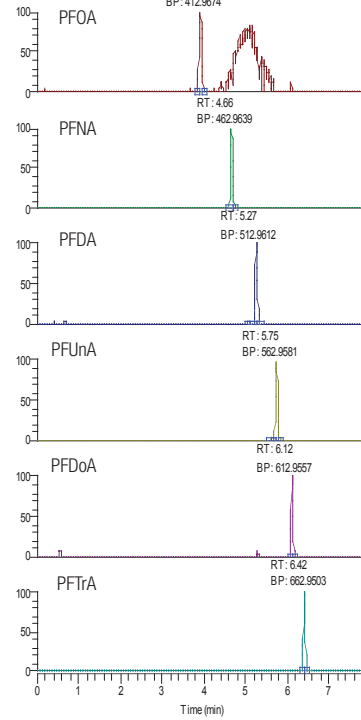

Figure 5. Extracted chromatograms: (a) Blank, (b) Standard, (c) Arctic seal extract

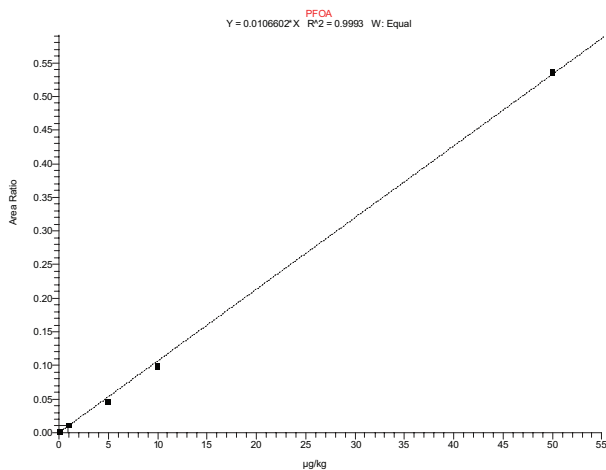

Figure 6. Calibration curve for PFOA

### Conclusion

Full scan in negative mode LC-MS acquisition on the Exactive LC-MS system with Orbitrap technology is suitable for quantification of PFAAs at low concentrations ranging from 0.1 µg/kg to 50 µg/kg in complex matrix extracts. No tuning or fragment determination is required and there is less background with high-resolution, accurate mass acquisition.

### Reference

1. Bossi, R.; Riget, F.F.; Dietz, R.; Sonne, C.; Fauser, P.; Dam, M.; Vorkamp, K. *Environmental Pollution* 2005, 136, 323-329.

In addition to these offices, Thermo Fisher Scientific maintains a network of representative organizations throughout the world.

- Africa-Other**  
+27 11 570 1840
- Australia**  
+61 3 9757 4300
- Austria**  
+43 1 333 50 34 0
- Belgium**  
+32 53 73 42 41
- Canada**  
+1 800 530 8447
- China**  
+86 10 8419 3588
- Denmark**  
+45 70 23 62 60
- Europe-Other**  
+43 1 333 50 34 0
- Finland/Norway/Sweden**  
+46 8 556 468 00
- France**  
+33 1 60 92 48 00
- Germany**  
+49 6103 408 1014
- India**  
+91 22 6742 9434
- Italy**  
+39 02 950 591
- Japan**  
+81 45 453 9100
- Latin America**  
+43 1 333 50 34 0
- Middle East**  
+43 1 333 50 34 0
- Netherlands**  
+31 76 579 55 55
- New Zealand**  
+64 9 980 6700
- Russia/CIS**  
+43 1 333 50 34 0
- South Africa**  
+27 11 570 1840
- Spain**  
+34 914 845 965
- Switzerland**  
+41 61 716 77 00
- UK**  
+44 1442 233555
- USA**  
+1 800 532 4752

www.thermofisher.com

Legal Notices: ©2016 Thermo Fisher Scientific Inc. All rights reserved. All trademarks are the property of Thermo Fisher Scientific Inc. and its subsidiaries. This information is presented as an example of the capabilities of Thermo Fisher Scientific Inc. products. It is not intended to encourage use of these products in any manners that might infringe the intellectual property rights of others. Specifications, terms and pricing are subject to change. Not all products are available in all countries. Please consult your local sales representative for details.

AN63478\_E 08/16S



# Sensitive and Accurate Quantitation of Perfluorinated Compounds in Human Breast Milk using Selected Reaction Monitoring Assays by LC/MS/MS

Christine Gu, Guifeng Jiang, Robert Szilasie, Stephen Hassan, Allen Zhang, Mark Sanders, Thermo Fisher Scientific, San Jose, CA, USA

## Key Words

- PFC-free Accela
- TSQ Vantage
- High Resolution MS
- H-SRM
- Perfluorinated Compounds

## Overview

Perfluorinated compounds (PFCs) are ubiquitous and persistent pollutants that bioaccumulate in animals and humans. The potential toxicity of these chemicals has fueled efforts to develop robust analytical techniques for measuring low levels of PFCs in human matrices. Quantitative selected reaction monitoring (SRM) assays were developed for six PFCs using the Thermo Scientific TSQ Vantage triple-stage quadrupole mass spectrometer (MS) coupled to a PFC-free Thermo Scientific Accela LC system. Using this method, PFCs were accurately and reproducibly detected at ppt concentrations in neat solution and in human milk matrix. Exceptionally sensitive and accurate, this integrated LC-MS platform is ideally suited for robust ultra-trace analysis of PFCs in a wide range of matrices.

## Introduction

The unique water-, oil-, grease-, stain- and heat-resistant properties of perfluorinated compounds (PFCs) have led to their widespread use in diverse industrial applications and multiple consumer products for over fifty years. Resistant to degradation, many of these synthetic compounds have become persistent and ubiquitous environmental pollutants. Bioaccumulation of PFCs in wildlife and in humans as well as studies linking some of these chemicals to developmental, reproductive and systemic toxicity in laboratory animals have led to efforts to regulate these compounds and have prompted the need for PFC monitoring and risk assessment in humans.<sup>1,2</sup> PFCs are detectable in human serum and breast milk and have even been found to be present in the blood of newborns, possibly through lactational transfer from mothers.<sup>3</sup> Determination of exposure pathways and health outcomes requires sensitive and accurate methods for trace-level analysis of PFCs in a range of human and environmental matrices.

PFCs encompass neutral and ionic species that contain the perfluorinated alkyl moiety. While gas chromatography-mass spectrometry (GC/MS) methods have been used to analyze volatile neutral PFCs and derivatives of ionic PFCs, many of these chemicals are more amenable to other analytical techniques. Liquid chromatography-tandem mass spectrometry (LC/MS/MS) is the method of choice for the analysis of ionic PFCs in a variety of matrices, but

accurate quantification has proven to be difficult using this technique due to background PFC contamination and matrix interferences. These analytical challenges underscore the need for a high performance LC-MS platform capable of exceptional sensitivity, selectivity and accuracy.

The TSQ Vantage™ triple-stage quadrupole MS coupled to the Accela™ high speed LC system enables rapid, accurate and robust LC/MS/MS analysis of small molecules and biomolecules. Delivering up to a 10-fold improvement in signal-to-noise ratio compared to existing triple-quadrupole MS systems, the TSQ Vantage mass spectrometer facilitates high-sensitivity quantitation in matrix-rich samples and enhances analytical accuracy and precision. The instrument is capable of high resolution (0.2 Da. FWHM) selection of precursor ions, enabling highly selective reaction monitoring (H-SRM) for greater analytical selectivity and accuracy. The Accela system, together with 1.9 μm particle columns, enables fast and efficient chromatographic separations over an expansive range of flow rates and pressures.

In this note, we demonstrate highly sensitive, accurate and reproducible analysis and quantitation of six PFCs in neat solution and in human breast milk matrix using selected reaction monitoring (SRM) and H-SRM on the integrated UHPLC Accela-TSQ Vantage LC-MS platform. Elimination of PFC contamination from the analytical system was achieved by using a PFC-free Accela pump with a pre-cleaned PFC-free degasser and replacing Teflon® tubing with PEEK tubing. The excellent sensitivity and selectivity afforded by SRM on the TSQ Vantage system obviated the need for any further modifications of the LC configuration, a distinct advantage over other commercial platforms that require the use of in-line contaminant traps or column-switching methods for PFC analysis.

## Materials and Methods

### Sample Preparation

#### PFC Standard Solutions

Standards for perfluoro-1-butanefluoride (PFBS), perfluoro-1-hexanesulfonate (PFHxS), perfluoro-n-heptanoic acid (PFHpA), perfluoro-1-decanesulfonate (PFDS), perfluoro-n-undecanoic acid (PFUnA), and perfluoro-n-dodecanoic acid (PFDoA) were obtained from a proprietary source. A stock solution of a mixture of these six PFCs was prepared at a concentration of 1 mg/L. Calibration solutions, with concentrations of 0.04-2.5 ng/mL (ppb), were prepared by serial dilution of the stock solution in 60:40 (v/v) methanol/water. Two internal standards, m-PFUnA and m-PFHxS, were added into each calibration solution and sample at 2 ng/mL (ppb) concentration.

#### Milk Matrix A

A 2 g human breast milk sample, obtained from a proprietary source, was diluted in acetonitrile to precipitate proteins. Weak anion exchange solid-phase extraction was performed and the resulting PFC extract was eluted using 2% ammonium hydroxide in methanol, evaporated to dryness and reconstituted in 60% methanol/water (0.6 mL).

#### Milk Matrix B

The six PFCs were spiked into Matrix A at concentrations of 0.1 ng/mL to generate Matrix B.

#### Milk Matrix C

To generate Matrix C, six PFCs were spiked into Matrix A at concentrations of 0.3 ng/mL.

#### Milk Matrix D

Matrix D was prepared by spiking the six PFCs into Matrix A at concentrations of 1.0 ng/mL.

### LC/MS Analysis

#### Instrumentation

LC/MS analysis was performed on a PFC-free Accela 600 LC system and PAL autosampler coupled to a TSQ Vantage triple-stage quadrupole mass spectrometer. The PFC-free Accela pump was equipped with a pre-cleaned PFC-free degasser and all Teflon tubing was replaced with PEEK tubing.

#### LC Parameters

Column:	Thermo Fisher Scientific Hypersil GOLD PFP column (100 x 3 mm, 1.9 µm particle size)			
Mobile Phase:	A: 5 mM ammonium acetate and 10% methanol/water B: 2 mM ammonium acetate/99% methanol			
Flow Rate:	see gradient			
Column Temperature:	ambient			
Sample Injection Volume:	10 µL			
Gradient:	Time (min)	A%	B%	Flow rate (µL/min)
	0.0	70	30	400
	0.5	70	30	400
	1.0	54	46	400
	4.0	30	70	400
	9.0	12	88	400
	9.4	12	88	400
	9.6	0	100	400
	9.7	0	100	500
	11.0	0	100	500
	11.1	70	30	500
	14.5	70	30	500
	15.0	70	30	400

#### MS Parameters

Negative Ion Mode Ionization with HESI Probe	
Heated Electrospray Ionization Source Conditions:	
Spray Voltage:	3500 V
Capillary Temperature:	300 °C
Sheath Gas:	60 au
Auxiliary Gas:	15 au
Vaporizer Temperature:	400 °C
Resolution for SRM Setup:	Q1, Q3 = Unit [0.7 Da. FWHM]
Resolution for H-SRM Setup:	Q1 = 0.2 Da. FWHM; Q3 = 0.7 Da. FWHM

#	Parent	Product	Collision Energy	RT Start	RT End	S-Lens	Name
1	299.0	80.2	43	3.15	4.15	115	PFBS
2	299.0	99.2	34	3.15	4.15	115	PFBS
3	299.0	169.0	23	3.15	4.15	115	PFBS
4	399.0	80.2	45	4.7	5.7	89	PFHxS
5	399.0	99.2	35	4.7	5.7	89	PFHxS
6	399.0	169.1	29	4.7	5.7	89	PFHxS
7	403.0	84.2	43	4.7	5.7	89	m-PFHxS
8	403.0	103.2	37	4.7	5.7	89	m-PFHxS
9	363.0	169.0	10	5.0	6.0	51	PFHpA
10	363.0	319.0	17	5.0	6.0	51	PFHpA
11	598.9	99.1	47	7.1	8.1	128	PFDS
12	598.9	230.1	50	7.1	8.1	128	PFDS
13	598.9	80.3	47	7.1	8.1	128	PFDS
14	562.9	269.0	18	7.75	8.75	62	PFUnA
15	562.9	519.0	12	7.75	8.75	62	PFUnA
16	564.9	520.0	18	7.75	8.75	64	m-PFUnA
17	612.9	169.0	25	8.4	9.4	78	PFDoA
18	612.9	569.0	12	8.4	9.4	78	PFDoA

Table 1: SRM transitions monitored for the detection of PFBS, PFHxS, PFHpA, PFDS, PFUnA and PFDoA.

## Results and Discussion

### Separation of PFC Standards

A total of fifteen unique SRM transitions were monitored for PFBS, PFHxS, PFHpA, PFDS, PFUnA and PFD<sub>o</sub>A, and three were monitored for the internal standards m-PFHxS and m-PFUnA (Table 1). Using the modified PFC-free LC-MS platform, a mixture of the six PFC standards was separated and detected under 10 minutes (Figure 1). All of the compounds were baseline resolved with the elution order of PFBS, PFHxS (m-PFHxS), PFHpA, PFDS, PFUnA (m-PFUnA) and PFD<sub>o</sub>A. As the majority of interferences from matrices elute early at void volume, elution of the first compound at 3.64 min ensured a robust quantitation method.

### Linearity and Sensitivity

Excellent linearity in detector response was observed over the range of 0.04–2.5 ppb, with correlation coefficients greater than 0.999 for all transitions. Representative calibration curves for PFBS and PFUnA, obtained using the internal standard method, are shown in Figure 2, with coefficients of 0.9997 and 0.9996 respectively.

The sensitivity of the method is dependent on the levels of interferences that are present in the blank and in the solvents used. Limits of detection (LODs) and limits of quantitation (LOQs), defined as S/N ratio of 3 and 10, respectively, are shown in Table 2. LODs ranged from 2–174 ppt, and LOQs ranged from 5–756 ppt. PFBS and PFDS were detectable at 2 ppt and quantifiable at 5 ppt. Figure 3 shows the separation and detection of 10 ppt PFBS and 10 ppt PFDS at different SRM transitions, and the corresponding blanks as comparisons. The higher LOD and LOQ values observed for PFHpA, PFUnA and PFD<sub>o</sub>A may be attributed to interferences present in the blank and mobile phases.

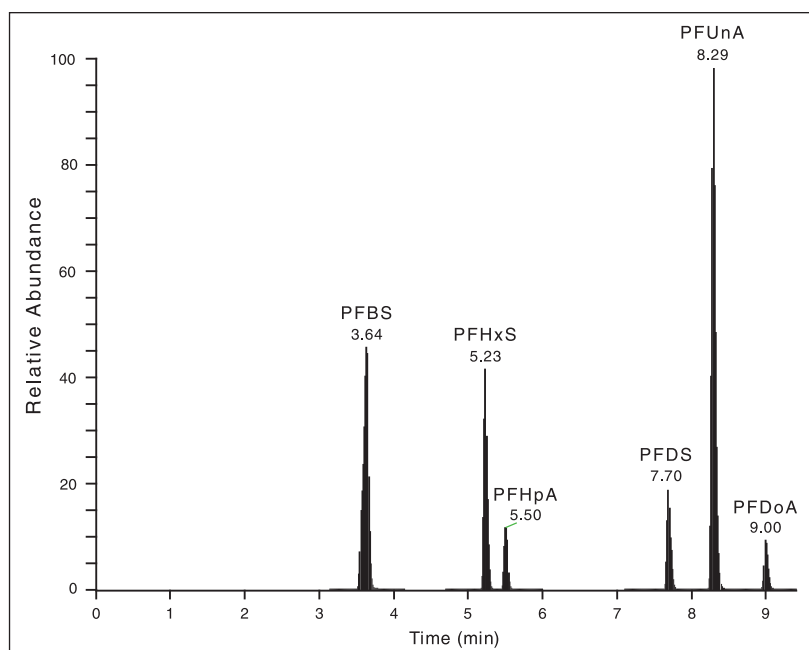

Figure 1: Separation and detection of six PFC standards at 2.5 ppb concentrations.

Compounds	SRM	LOD (ppt)	LOQ (ppt)		
PFBS	298.9 > 80.2	2	5	SRM	
	298.9 > 99.2	5	12	SRM	
PFHxS	398.9 > 80.2	21	83	SRM	
	398.9 > 99.2	12	66	SRM	
PFHpA	362.9 > 169.0	174	756	SRM	Blank Contamination
	362.9 > 319.0	120	457	SRM	Blank Contamination
PFDS	598.9 > 80.2	2	7	SRM	
	598.9 > 99.2	3	9	SRM	
PFUnA	562.9 > 269.0	35	156	SRM	
	562.9 > 519.0	52	235	SRM	
PFD <sub>o</sub> A	612.9 > 169.0	59	296	SRM	
	612.9 > 569.0	64	295	H-SRM	

Table 2: LODs and LOQs of the PFC standards. LOQs were estimated from triplicate injections (CV < 15%) of standard solutions at concentration levels corresponding to a signal-to-noise ratio of 10.

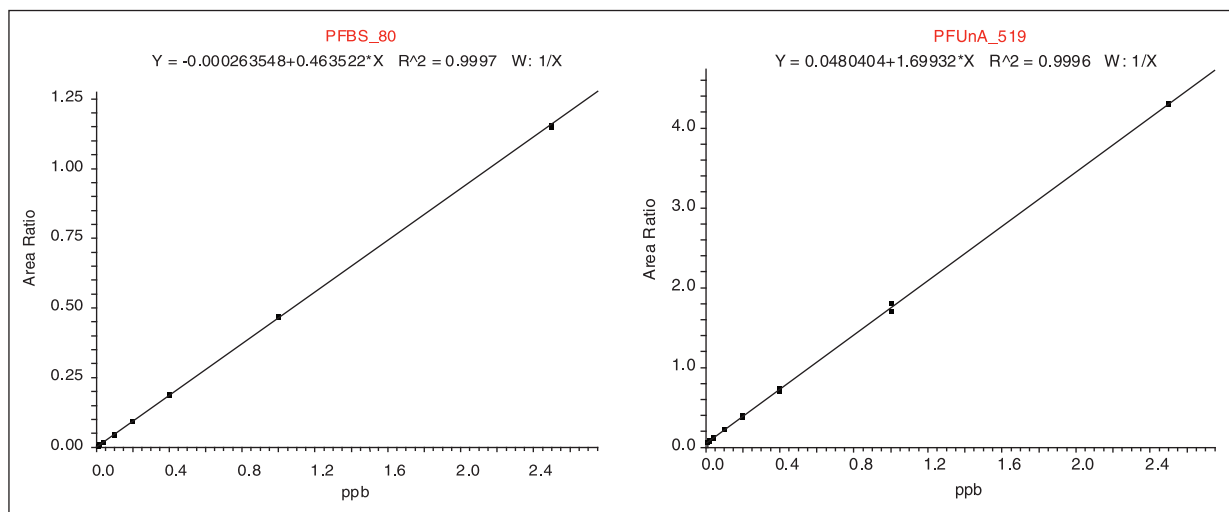

Figure 2: Representative calibration curves of PFBS and PFUnA standards.

Significant background interference was observed for the SRM transition 613 > 569 of PFDoA at Q1 resolution of 0.7 Da. FWHM, therefore H-SRM was employed. As shown in Figure 4, using the higher Q1 resolution of 0.2 Da. FWHM removed the matrix interference without compromising sensitivity. Moreover, sensitive and unambiguous PFC detection was achieved without the use of in-line trapping or column switching.

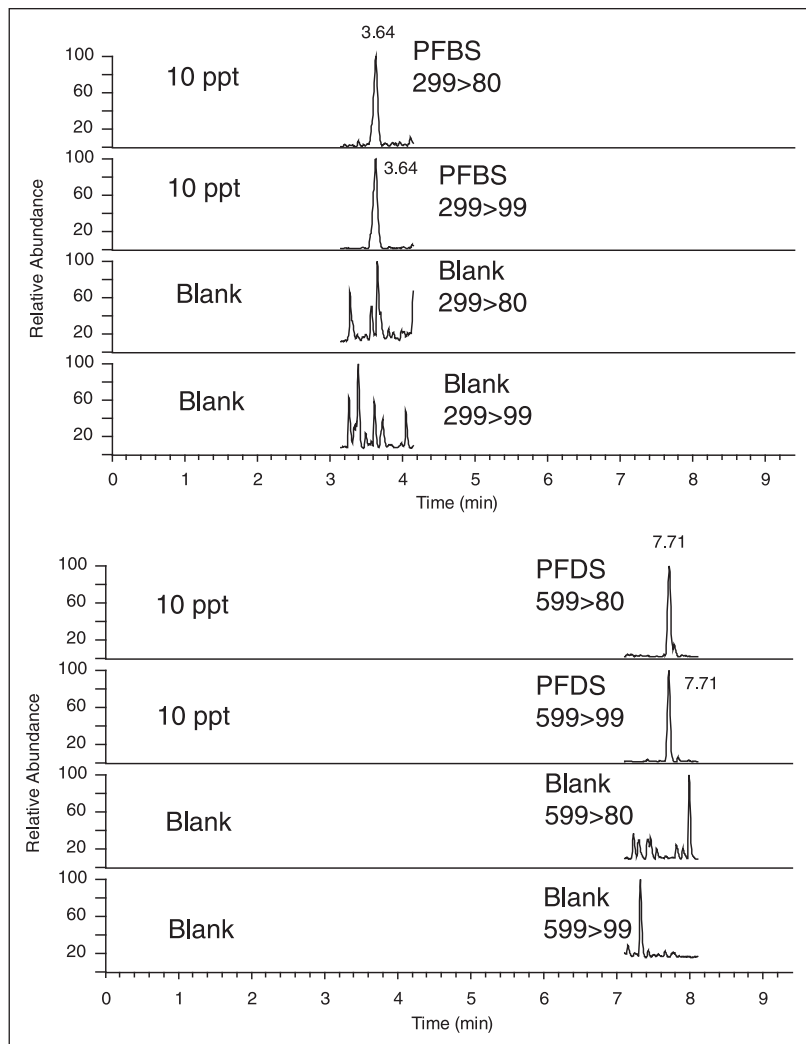

Figure 3. Separation and detection of 10 ppt of PFBA and PFDS.

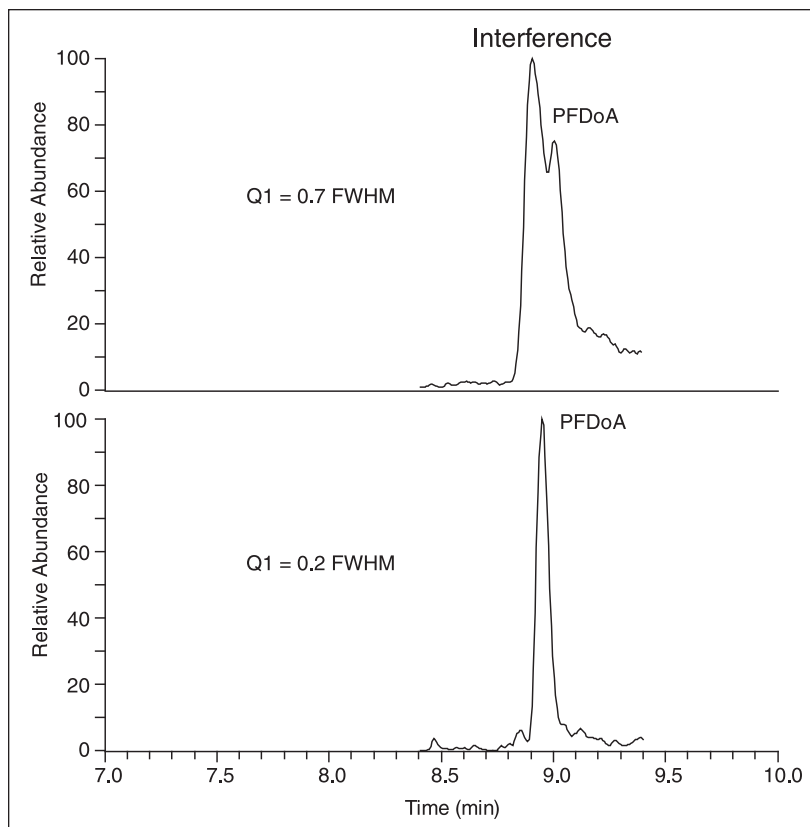

Figure 4: H-SRM eliminates interference peaks without any change in signal intensity.

## Analysis of PFCs in Human Milk Matrix

To evaluate the applicability of this technique to complex matrices, the SRM assays were used to analyze and quantitate PFCs in human breast milk. UHPLC separation of the six PFC analytes in a spiked milk matrix was achieved within 9 minutes (Figure 5). All analytes were baseline resolved using the optimized LC method.

Reproducibility was investigated by analyzing fifteen replicate injections of a spiked matrix (Table 3). Peak area RSDs for compounds and internal standards were 10.8% and 11.0% respectively, the response ratio RSD was 1.29%, and retention time RSD was 0.29%, indicating excellent method and system reproducibility, particularly of the LC pump.

File Name	Peak Area	ISTD Area	Response Ratio	RT (Min)
Mark D_0 17	149 369	8 268 9	1.806	8.29
Mark D_0 18	147 075	8 081 9	1.820	8.27
Mark D_0 19	145 882	8 127 6	1.795	8.29
Mark D_0 20	146 012	7 990 7	1.827	8.29
Mark D_0 21	143 987	8 071 2	1.784	8.27
Mark D_0 22	143 095	8 011 6	1.786	8.25
Mark D_0 23	140 298	7 802 3	1.798	8.25
Mark D_0 67	121 597	6 929 2	1.755	8.25
Mark D_0 68	119 763	6 776 4	1.767	8.29
Mark D_0 69	119 149	6 654 3	1.791	8.27
Mark D_0 70	121 775	6 647 6	1.832	8.32
Mark D_0 71	113 885	6 376 6	1.786	8.27
Mark D_0 72	115 138	6 271 2	1.836	8.31
Mark D_0 73	116 884	6 561 6	1.781	8.24
Mark D_0 74	114 601	6 358 6	1.802	8.31
<b>RSD%</b>	<b>11</b>	<b>10.8</b>	<b>1.29</b>	<b>0.29</b>

Table 3: Reproducibility (RSD) of instrument performance for fifteen replicate injections of Matrix D. Peak area is the LC peak area response for fifteen injections. Peak area was used for quantitation, both for the internal standard method and external standard method. ISTD area = peak area of the internal standard. Response ratio is the peak area of the compounds over the peak area of the internal standard, and was used for quantitation with the internal standard method. RT = retention time.

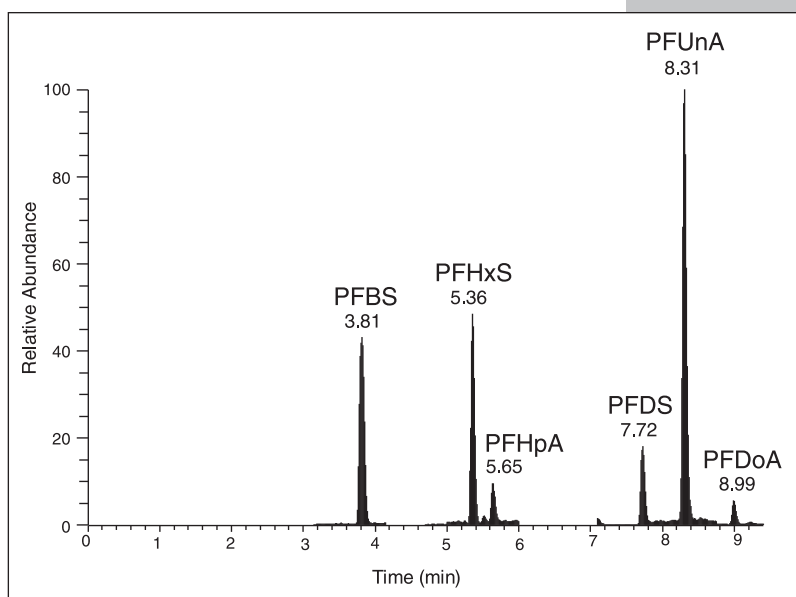

Figure 5: The separation and detection of the PFCs in human milk matrices C

Table 4 summarizes the concentrations of the PFCs detected in a human milk sample (Matrix A). PFBS, PFHxS, PFHpA, PFDS, and PFUnA were detected at concentrations of less than 60 ppt, while PFDoA was not found to be present in the sample. Assay accuracy was investigated using spiked milk matrices B, C, and D and internal and external standards (Table 3). For PFHxS and PFUnA, the two PFCs for which internal standards were available, using the internal standard method was significantly more accurate (98–110%) than the external standard method (81–144%) in the concentration range 0.1–1.0 ng/mL. While internal standards eliminate the matrix effect to facilitate greater quantitative accuracy, they are expensive and may be difficult to obtain. Using the external standard method, the accuracy of all PFC analytes was 81–144% in the concentration range 0.1–1.0 ng/mL.

		PFBS	PFHxS	PFHpA	PFDS	PFUnA	PFDoA
<b>Matrix A</b> (unknown)	Measured value with IS (ppt)		48.0			12.0	
	Measured value with ES (ppt)	10.0	40.0	50.0	50.0	35.0	0.0
<b>Matrix B</b> (Matrix A + spiked 100 ppt)	Measured value with IS (ppt)		152			115	
	Measured value with ES (ppt)	110	145	185	150	195	130
	Method Accuracy with IS (%)		103			103	
	Method Accuracy with ES (%)	100	104	123	100	144	130
<b>Matrix C</b> (Matrix A + spiked 300 ppt)	Measured value with IS (ppt)		382			340	
	Measured value with ES (ppt)	260	290	365	285	420	280
	Method Accuracy with IS (%)		110			109	
	Method Accuracy with ES (%)	84	85	104	81	125	93
<b>Matrix D</b> (Matrix A + spiked 1000 ppt)	Measured value with IS (ppt)		1023			1042	
	Measured value with ES (ppt)	930	945	1255	935	1495	985
	Method Accuracy with IS (%)		98			103	
	Method Accuracy with ES (%)	92	91	120	89	144	99

Table 4: PFC concentrations (ppt) in human milk matrix A and spiked milk matrices B, C, and D. Note: The method accuracy was calculated with the formula of 100 x measure value/(measure value of Matrix A + spiked value).

## Conclusion

A highly sensitive, accurate and robust SRM-based approach for PFC analysis was developed on a PFC-free Accela-TSQ Vantage LC-MS platform. PFCs were accurately and reproducibly detected at ppt levels in neat solution and in human milk. The unique H-SRM capability of the TSQ Vantage instrument removed interference peaks and significantly improved selectivity. Furthermore, unlike other approaches, this platform does not require trapping or column switching techniques to ensure exceptional sensitivity in high chemical backgrounds.

## References

1. <http://www.epa.gov/oppt/pfoa/>
2. [http://www.epa.gov/head/regulatory/projects/d1b\\_right\\_to\\_know.html](http://www.epa.gov/head/regulatory/projects/d1b_right_to_know.html)
3. Tao, L.; Kannan, K.; Wong, C.M.; Arcaro, K. F.; Butenhoff, J.L. Perfluorinated compounds in human milk from Massachusetts, U.S.A. *Environ Sci Technol.* 2008 42, 3096-101.

*In addition to these offices, Thermo Fisher Scientific maintains a network of representative organizations throughout the world.*

**Africa-Other**  
+27 11 570 1840

**Australia**  
+61 3 9757 4300

**Austria**  
+43 1 333 50 34 0

**Belgium**  
+32 53 73 42 41

**Canada**  
+1 800 530 8447

**China**  
+86 10 8419 3588

**Denmark**  
+45 70 23 62 60

**Europe-Other**  
+43 1 333 50 34 0

**Finland/Norway/Sweden**  
+46 8 556 468 00

**France**  
+33 1 60 92 48 00

**Germany**  
+49 6103 408 1014

**India**  
+91 22 6742 9434

**Italy**  
+39 02 950 591

**Japan**  
+81 45 453 9100

**Latin America**  
+1 561 688 8700

**Middle East**  
+43 1 333 50 34 0

**Netherlands**  
+31 76 579 55 55

**New Zealand**  
+64 9 980 6700

**South Africa**  
+27 11 570 1840

**Spain**  
+34 914 845 965

**Switzerland**  
+41 61 716 77 00

**UK**  
+44 1442 233555

**USA**  
+1 800 532 4752

[www.thermofisher.com](http://www.thermofisher.com)

**Legal Notices:** ©2016 Thermo Fisher Scientific Inc. All rights reserved. Teflon is a registered trademark of E.I. du Pont de Nemours and Company. All other trademarks are the property of Thermo Fisher Scientific Inc. and its subsidiaries. This information is presented as an example of the capabilities of Thermo Fisher Scientific Inc. products. It is not intended to encourage use of these products in any manners that might infringe the intellectual property rights of others. Specifications, terms and pricing are subject to change. Not all products are available in all countries. Please consult your local sales representative for details.

AN51936\_E 08/16M



# Determination of PCDD/Fs in Environmental Samples using Accelerated Solvent Extraction (ASE) and GC-MS/MS

Paul Silcock,<sup>1</sup> David Gardner,<sup>2</sup> John Fardon,<sup>2</sup> Steve Moss<sup>2</sup> and Inge de Dobbeleer<sup>1</sup>

<sup>1</sup>Thermo Scientific POPs Centre of Excellence, Bremen, Germany

<sup>2</sup>National Laboratory Service - Environment Agency, Leeds, United Kingdom

## Key Words

Dioxins, furans, PCDD, PCDF, environmental, fly ash, sediments, complex matrix, accelerated solvent extraction, isotope dilution, pressurized solvent extraction

## Introduction

The measurement of PCDD/Fs in the environment is a widespread activity carried out by many regulatory agencies globally. The chronic toxicity of these compounds to humans and wildlife at extremely low concentrations requires that the techniques used in determination must be both sensitive and selective enough to allow high confidence results. This is especially true when measuring background levels in environmental matrices, such as soil and sediment or byproducts from waste incineration processes. Traditionally high resolution magnetic sector GC-MS (GC-HRMS) instrumentation has delivered the required analytical performance and has become the gold standard technique. In recent years, there has been more interest in GC triple-quadrupole instrumentation for this purpose, especially in the area of food safety control.<sup>1,2</sup> For this area and environmental analysis, it is necessary to deliver data that performs in the range of HRMS systems, which requires especially sensitive triple-quadrupole systems. It is also necessary to incorporate data-processing software specifically designed to handle the complex calculations associated with dioxins analysis.

This application note describes the use of the Thermo Scientific™ TSQ Quantum™ XLS Ultra GC-MS/MS as applied to the analysis of PCDDs/PCDFs in sediments, soils, bottom, and fly ash (as incineration by-products) at the levels of interest and the level of agreement with “gold standard” analysis using GC-HRMS.

During this study, instrumental LOQs using GC-MS/MS were calculated in the low fg/μL concentration ranges. This, along with further analytical performance, is discussed alongside GC-HRMS; especially the degree of agreement between the techniques in some routine sample batches.



## Materials and Methods

### Extraction and Cleanup

The standard spiking protocols, extraction, and cleanup process for all sediment and soil samples were performed using an ISO17025 accredited in-house variation of EPA 1613B3. For incinerator ash samples, an in-house method based upon EN 19484 was applied.

For both of these methods, accelerated solvent extraction was used as the preferred technique for extraction after initial sample processing. This is routinely used in the laboratory to reduce solvent consumption, allow for automation, and to generate efficient sample extractions within the performance limits required.



## Accelerated Solvent Extraction Methods

ASE cells were loaded with a base layer of copper filings then a layer of rinsed Ottawa sand (previously ashed at 450 °C) after which 5 g of sample for soils/sediments (1 g for fly ash). Finally, another layer of sand was added to fill the cell and then extracted (Figure 1).

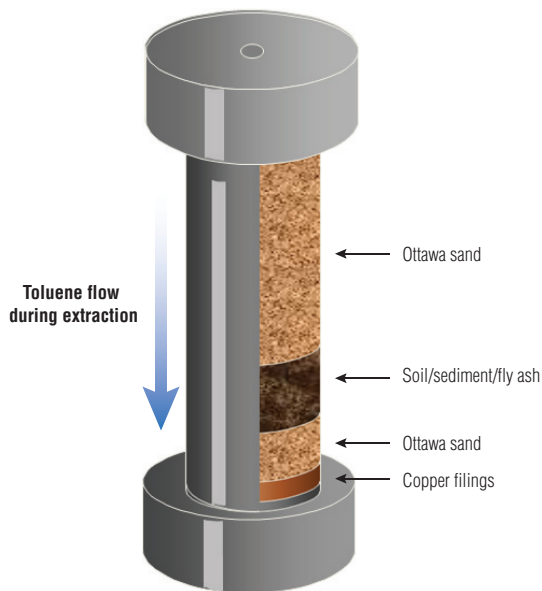

Extraction Solvent:	Toluene
Extraction Pressure:	1500 psi
Oven Temperature:	175 °C
Heating Time:	8 minutes
Static Time:	5 minutes
Flush:	60 % Cell volume
Purge:	N <sub>2</sub> 240 Seconds

Figure 1. Cell schematic and method conditions for the extraction of PCDD/Fs from soil, sediment, and fly ash samples.

## GC-MS Measurement & Data Processing

The GC-MS/MS measurements were performed using a Thermo Scientific™ TRACE™ GC Ultra coupled to a TSQ Quantum XLS Ultra GC-MS/MS system with quantitation performed using Thermo Scientific TargetQuan 3 software. Tables 1 and 2 show the instrument parameters used.

Table 1. GC and injector conditions.

Split/Splitless Injector (PCDD/Fs)	
Injection Temperature	260 °C
Liner	Splitless straight liner (Siltek) 3 × 8 × 105 mm (PN 453T2121)
Injected Volume	2 µL (toluene)
Splitless Time	1.5 min
Surge Pressure	22 psi (1 min)

GC Program	
GC Column	TraceGOLD TG-5SiMS 60m × 0.25mm × 0.25µm (PN 26096-1540)
GC Column Flow	1.2 mL/min constant
Initial Temperature	120 °C
Rate 1	18 °C/min to 200 °C (10 min)
Rate 2	4 °C/min to 290 °C
Final Temperature	290 °C for 15 min

Table 2. Mass spectrometer parameters.

Parameters	
Source Temperature	250 °C
Ionization	EI
Electron Energy	40 eV
Emission Current	50 µA
Q2 Gas Pressure (Argon)	1.5 mTorr
Collision Energy	22 eV
Q1 Peak Width FWHM	0.7 Da
Q3 Peak Width FWHM	0.7 Da

The collision cell (Q2) gas pressure and collision energy were optimized for PCDD/F measurement at 22 eV. The monitored selected reaction monitoring (SRM) transitions as well as the MS conditions are given below in Table 3.

Table 3. Target congener groups SRM transitions.

Compound Name	Abrev.	Formula	Nominal Mass	Exact Mass	Presursor Ion m/z	Product Ion m/z	Collision Energy [eV]
Tetrachloro-dibenzodioxin	TCDD	C <sub>12</sub> H <sub>4</sub> O <sub>2</sub> Cl <sub>4</sub>	320	319.8965	319.90	256.93	22
					321.89	258.93	22
Pentachloro-dibenzodioxin	PeCDD	C <sub>12</sub> H <sub>3</sub> O <sub>2</sub> Cl <sub>5</sub>	354	353.8576	355.85	292.89	22
					357.85	294.89	22
Hexachloro-dibenzodioxin	HeCDD	C <sub>12</sub> H <sub>2</sub> O <sub>2</sub> Cl <sub>6</sub>	388	387.8186	387.82	324.86	22
					389.82	326.85	22
Heptachloro-dibenzodioxin	HpCDD	C <sub>12</sub> H <sub>1</sub> O <sub>2</sub> Cl <sub>7</sub>	422	421.7796	423.78	360.81	22
					425.77	362.81	22
Octachloro-dibenzodioxin	OCDD	C <sub>12</sub> O <sub>2</sub> Cl <sub>8</sub>	456	455.7407	457.74	394.77	22
					459.74	396.77	22
Tetrachloro-[ <sup>13</sup> C <sub>12</sub> ]dibenzodioxin	TCDD	<sup>13</sup> C <sub>12</sub> H <sub>4</sub> O <sub>2</sub> Cl <sub>4</sub>	332	331.9368	331.94	267.97	22
					333.93	269.97	22
Pentachloro-[ <sup>13</sup> C <sub>12</sub> ]dibenzodioxin	PeCDD	<sup>13</sup> C <sub>12</sub> H <sub>3</sub> O <sub>2</sub> Cl <sub>5</sub>	366	365.8978	367.90	303.93	22
					369.89	305.89	22
Hexachloro-[ <sup>13</sup> C <sub>12</sub> ]dibenzodioxin	HeCDD	<sup>13</sup> C <sub>12</sub> H <sub>2</sub> O <sub>2</sub> Cl <sub>6</sub>	400	399.8589	399.86	335.89	22
					401.86	337.89	22
Heptachloro-[ <sup>13</sup> C <sub>12</sub> ]dibenzodioxin	HpCDD	<sup>13</sup> C <sub>12</sub> H <sub>1</sub> O <sub>2</sub> Cl <sub>7</sub>	434	433.8199	435.82	371.85	22
					437.81	373.85	22
Octachloro-[ <sup>13</sup> C <sub>12</sub> ]dibenzodioxin	OCDD	<sup>13</sup> C <sub>12</sub> O <sub>2</sub> Cl <sub>8</sub>	468	467.7809	469.78	405.81	22
					471.78	407.81	22
Tetrachloro-dibenzofuran	TCDF	C <sub>12</sub> H <sub>4</sub> OCl <sub>4</sub>	304	303.9016	303.90	240.94	22
					305.90	242.94	22
Pentachloro-dibenzofuran	PeCDF	C <sub>12</sub> H <sub>3</sub> OCl <sub>5</sub>	338	337.8627	339.86	276.90	22
					341.86	278.89	22
Hexachloro-dibenzofuran	HeCDF	C <sub>12</sub> H <sub>2</sub> OCl <sub>6</sub>	372	371.8237	371.82	308.86	22
					373.82	310.86	22
Heptachloro-dibenzofuran	HpCDF	C <sub>12</sub> H <sub>1</sub> OCl <sub>7</sub>	406	405.7847	407.78	344.82	22
					409.78	346.82	22
Octachloro-dibenzofuran	OCDF	C <sub>12</sub> OCl <sub>8</sub>	440	439.7457	441.76	378.80	22
					443.76	380.79	22
Tetrachloro-[ <sup>13</sup> C <sub>12</sub> ]dibenzofuran	TCDF	<sup>13</sup> C <sub>12</sub> H <sub>4</sub> OCl <sub>4</sub>	316	315.9419	315.94	251.97	22
					317.94	253.97	22
Pentachloro-[ <sup>13</sup> C <sub>12</sub> ]dibenzofuran	PeCDF	<sup>13</sup> C <sub>12</sub> H <sub>3</sub> OCl <sub>5</sub>	350	349.9029	351.90	287.93	22
					353.90	289.93	22
Hexachloro-[ <sup>13</sup> C <sub>12</sub> ]dibenzofuran	HeCDF	<sup>13</sup> C <sub>12</sub> H <sub>2</sub> OCl <sub>6</sub>	384	383.8639	383.86	319.90	22
					385.86	321.89	22
Heptachloro-[ <sup>13</sup> C <sub>12</sub> ]dibenzofuran	HpCDF	<sup>13</sup> C <sub>12</sub> H <sub>1</sub> OCl <sub>7</sub>	418	417.8250	419.82	355.86	22
					421.82	357.85	22
Octachloro-[ <sup>13</sup> C <sub>12</sub> ]dibenzofuran	OCDF	<sup>13</sup> C <sub>12</sub> OCl <sub>8</sub>	452	451.7860	453.78	389.82	22
					455.78	391.81	22

## Results and Discussion

### Sensitivity for PCDD/F Analysis

The prerequisites for a technique to be applicable to low level PCDD/F determinations is sensitivity and selectivity. The concentration levels where these substances are required to be measured often exceed the performance capability of bench-top GC-MS systems. In order to test the sensitivity of the TSQ Quantum XLS Ultra for this application, a serial dilution of commonly used EPA 1613B CS1 standard was performed, and increasingly low levels were injected onto the system. The limit of detection (LOD) was then calculated using statistical methods. Figure 2 shows the lowest level CS1 dilution ( $\times 10$  – vial concentrations given in Table 4) used for this study. Quantitative SRM ions are clearly detected along with the confirmatory SRM ions for all PCDD/Fs tested within the QC ion ratio criteria. Precision studies at this level enabled an LOD to be calculated for the methodology. Table 4 gives the precision data obtained and calculated LOD at 99 % confidence limits. The LOD obtained from the TSQ Quantum XLS Ultra was found at a level that is highly applicable for environmental dioxins analysis in a range of sample types.

Table 4. Instrumental LOD (pg/ $\mu$ L) given to 2 d.p. (99% confidence) and precision data (n=10) for PCDD/Fs from GC-MS/MS analysis of a ten times diluted EPA 1613 CS1.

	Concentration pg/ $\mu$ L	RSD %	LOD (99) pg/ $\mu$ L
2,3,7,8 TCDF	0.05	6.2	0.01
2,3,7,8 TCDD	0.05	11.1	0.01
1,2,3,7,8 PeCDF	0.25	6.0	0.03
2,3,4,7,8-PeCDF	0.25	4.6	0.03
1,2,3,7,8 PeCDD	0.25	9.2	0.05
1,2,3,4,7,8-HxCDF	0.25	7.7	0.04
1,2,3,6,7,8-HxCDF	0.25	4.7	0.03
2,3,4,6,7,8-HxCDF	0.25	4.1	0.02
1,2,3,4,7,8-HxCDD	0.25	7.7	0.04
1,2,3,6,7,8-HxCDD	0.25	6.1	0.03
1,2,3,7,8,9-HxCDD	0.25	5.0	0.03
1,2,3,7,8,9-HxCDF	0.25	4.9	0.03
1,2,3,4,6,7,8-HpCDF	0.25	5.2	0.03
1,2,3,4,6,7,8-HpCDD	0.25	6.8	0.04
1,2,3,4,7,8,9-HpCDF	0.25	5.7	0.03
OCDD	0.5	7.9	0.09
OCDF	0.5	4.8	0.05

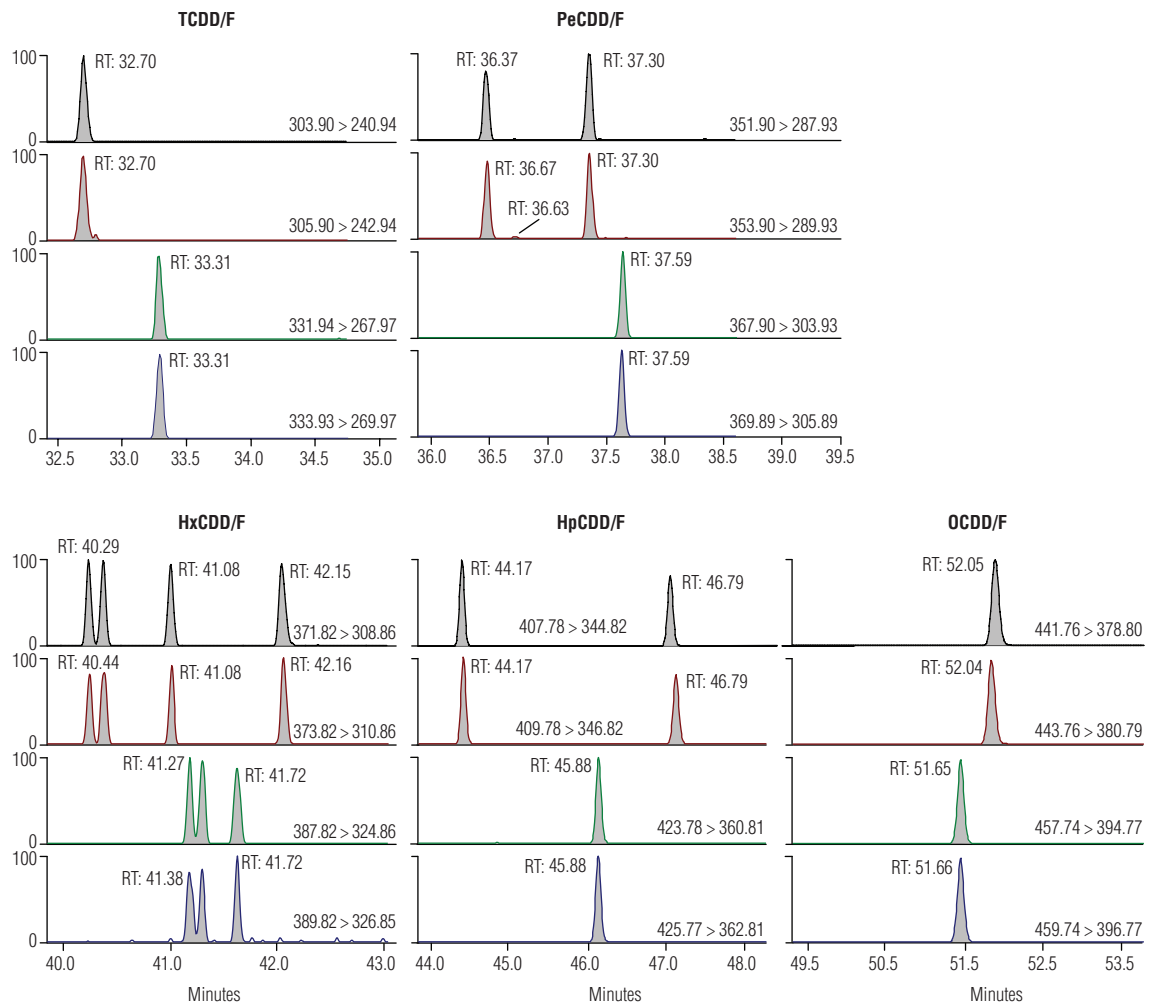

Figure 2. SRM chromatograms of PCDD/Fs after injection of a 10x diluted EPA1613B CS1 standard. (TCDD/F 0.05 pg/ $\mu$ L, PeCDD/F thru HpCDD/F 0.25 pg/ $\mu$ L, OCDD/F 0.5 pg/ $\mu$ L)

### Quality Control in Routine Sample Batches

To evaluate the quantitative performance of the TSQ Quantum XLS Ultra when applied to analytical quality control samples, data was taken and compared with that obtained on currently implemented GC-HRMS systems (see Figure 3). These quality control samples included certified reference materials (CRMs) for sediments SETOC 738 and CRM 490 incinerator fly ash. These were all processed through the entire method procedure which included accelerated sample extraction. All of the compound recovery QC criteria specified in EPA 1613 and EN1948 were satisfied. This gave confidence that the extraction yielded high recoveries throughout the study.

CRM 490 is a highly contaminated incinerator fly ash. This type of sample and level of contamination allows for a great opportunity for interference to occur. The MS/MS system measured consistently higher concentrations for TCDD/F and some penta and hexa furans. This was indeed closer to the true CRM consensus value, so the QC check passed.

SETOC 738 is a sediment CRM sample that is much lower level CRM and had good agreement in the calculated concentrations between the GC-MS/MS and HRMS data.

The GC-MS/MS data on these three types of QC sample all fell within acceptable performance limits for the current methodology suggesting that the selectivity and quantitative performance of the technique is applicable for reporting PCDD/F data in the routine environmental lab.

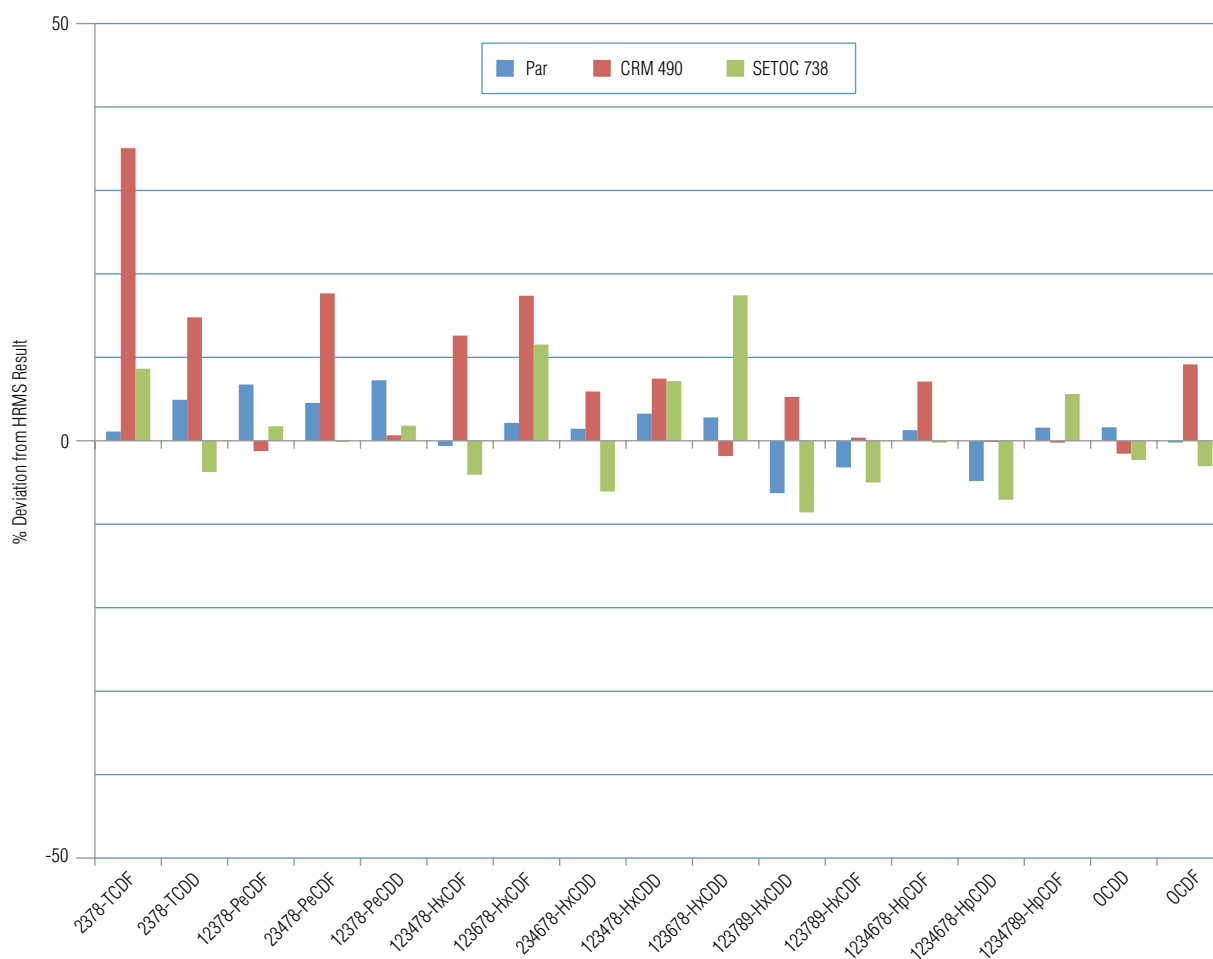

Figure 3. Mean GC-MS/MS results for routine laboratory QC samples for the in-house PCDD/Fs method over 3 routine batches of samples. This is plotted as difference to result obtained on the GC-HRMS system. The QCs include a precision and recovery standard (PAR), Incinerator fly ash certified reference material (CRM 490) and a sediment certified reference material (SETOC 738).

## Routine Samples

The QC performance was reflected in the real sample batches with generally very good agreement in results between the GC-MS/MS and GC-HRMS approach. Larger deviations in calculated value were reported for incinerator fly ash samples, particularly for the lower chlorinated PCDFs. These differences are thought to arise from selectivity differences in the two techniques. The GC-MS/MS result remained valid within the quality control criteria specified within the methodology. SRM chromatograms for TCDDs in three different routine environmental sample types are given in Figure 4. These include both quantifying and confirming SRM transitions. The selective detection of the highly significant 2,3,7,8-TCDD congener was achievable in all samples.

Calculated concentrations for each congener are given in Table 5 for both the GC-MS/MS and GC-HRMS analyses for routine soil, sediment, and a matrix QC sample. Again, these show a good level of agreement in the calculated result. For the soil samples, the TSQ Quantum XLS Ultra showed confirmed detections of PCDD/Fs for the low concentration samples when no result was reported from GC-HRMS. This was due to the lower performance of the GC-HRMS system used in this study and not directly related the more sensitive systems available today.

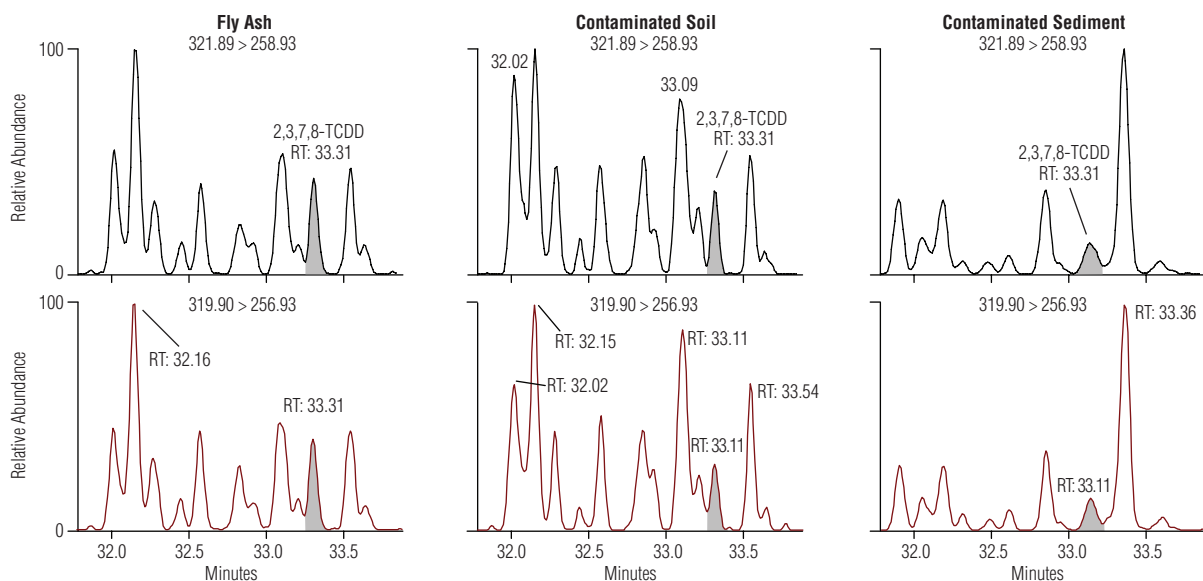

Figure 4. TCDD SRM chromatograms for three different sample types typically analyzed in the environmental laboratory.

Left: Fly ash (2,3,7,8-TCDD 31.4 ng/kg), Center: Contaminated soil (2,3,7,8-TCDD 1.85 ng/kg), Right: Contaminated sediment (2,3,7,8-TCDD 17.9 ng/kg).

Table 5. Calculated concentrations of TCDD/F congeners in soil and sediment samples run on both GC-MS/MS and GC-HRMS. (ND=not detected)

	Soil		Sediment 1		Sediment 2		SETOC 738 (CRM)	
	GC-MS/MS ng/kg	GC-HRMS ng/kg	GC-MS/MS ng/kg	GC-HRMS ng/kg	GC-MS/MS ng/kg	GC-HRMS ng/kg	GC-MS/MS ng/kg	GC-HRMS ng/kg
2,3,7,8 TCDF	0.992	1.23	16.0	10.4	2.15	1.51	17.9	17.1
2,3,7,8 TCDD	ND	ND	1.85	2.29	2.03	5.10	23.1	23.9
1,2,3,7,8 PeCDF	1.26	<1.79	25.4	25.4	4.90	4.52	7.36	6.76
2,3,4,7,8 PeCDF	1.57	1.96	41.5	44.2	10.7	9.29	47.8	45.4
1,2,3,7,8, PeCDD	0.436	ND	5.49	5.71	9.14	7.95	7.26	6.91
1,2,3,4,7,8,-HxCDF	1.89	1.89	56.1	57.3	64.8	71.9	43.8	45.1
1,2,3,6,7,8,-HxCDF	1.81	2.14	64.8	55.0	223	197	15.1	14.7
2,3,4,6,7,8,-HxCDF	2.53	2.83	86.9	91.5	9.47	11.5	20.2	18.4
1,2,3,4,7,8,-HxCDD	0.271	ND	5.38	6.34	15.0	10.9	10.4	8.62
1,2,3,6,7,8,-HxCDD	0.382	0.905	8.33	8.58	17.6	16.7	28.1	20.1
1,2,3,7,8,9-HxCDD	0.469	ND	6.62	6.97	17.5	14.0	21.4	22.4
1,2,3,7,8,9-HxCDF	0.932	ND	25.8	31.4	15.2	13.4	4.65	5.40
1,2,3,4,6,7,8-HpCDF	12.9	14.2	464	473	5.05	4.58	214	202
1,2,3,4,6,7,8-HpCDD	4.80	5.78	63.4	62.2	18.3	16.6	416	433
1,2,3,4,7,8,9-HpCDF	1.90	3.07	48.8	48.8	68.3	54.4	15.1	15.4
OCDD	24.7	23.8	153	191	6.38	5.38	3020	3030
OCDF	258	291	475	554	47.7	39.5	290	316

## Conclusion

- The TSQ Quantum XLS Ultra GC-MS/MS is a highly sensitive and selective system applicable to dioxins and furans analysis in a range of environmental sample types and generates results that perform within current in-house QC criteria.
- Some differences arise in the calculated concentration between the GC-MS/MS and GC-HRMS analysis. These are thought to be related to the differences in the selectivity mechanism of each system.
- GC-MS/MS applied to PCDD/Fs still allows for full isotope dilution quantitation as currently used by GC-HRMS systems. TargetQuan 3 software can be used with the TSQ Quantum XLS Ultra to provide the specific calculations required.
- The Thermo Scientific™ Dionex™ ASE™ Accelerated Solvent Extractor system allows for unattended, efficient extractions from all samples and enabled recoveries well within QC criteria.

## References

1. Ingelido, A. M.; Brambilla, G.; Abballe, A.; di Domenico, A.; Fulgenzi, A. R.; Iacovela, N.; Lamiceli, L.; Valentini, S.; De Felip, E. *Rapid Commun. Mass Spectrom.* **2012**, *26*(3), 236–242.
2. Kotz, A.; Malisch, R.; Wahl, K.; Bitomsky, N.; Adamovic, K.; Gerteisen, I.; Leswal, S.; Schächtele, J.; Tritschler, R.; Winterhalter, H. *Organohalogen Compd.* **2011**, *73*, 688–691.
3. Silcock, P.; Krumwiede, D.; de Dobbeleer, I.; Huebschmann, H. J.; Kotz, A. **2011**, Thermo Scientific Application Note 52266.

[www.thermofisher.com](http://www.thermofisher.com)

©2016 Thermo Fisher Scientific Inc. All rights reserved. All trademarks are the property of Thermo Fisher Scientific Inc. and its subsidiaries. Specifications, terms and pricing are subject to change. Not all products are available in all countries. Please consult your local sales representative for details.

**Africa-Other** +27 11 570 1840  
**Australia** +61 3 9757 4300  
**Austria** +43 1 333 50 34 0  
**Belgium** +32 53 73 42 41  
**Canada** +1 800 530 8447  
**China** +86 10 8419 3588  
**Denmark** +45 70 23 62 60

**Europe-Other** +43 1 333 50 34 0  
**Finland/Norway/Sweden**  
 +46 8 556 468 00  
**France** +33 1 60 92 48 00  
**Germany** +49 6103 408 1014  
**India** +91 22 6742 9434  
**Italy** +39 02 950 591

**Japan** +81 45 453 9100  
**Latin America** +1 561 688 8700  
**Middle East** +43 1 333 50 34 0  
**Netherlands** +31 76 579 55 55  
**New Zealand** +64 9 980 6700  
**Russia/CIS** +43 1 333 50 34 0  
**South Africa** +27 11 570 1840

**Spain** +34 914 845 965  
**Switzerland** +41 61 716 77 00  
**UK** +44 1442 233555  
**USA** +1 800 532 4752

AN10336\_E 08/16S

**Thermo**  
 S C I E N T I F I C

Part of Thermo Fisher Scientific



# Surface, Drinking and Waste Water Analysis

Marine Toxins



# Comprehensive Solutions for Screening, Quantitation and Discovery of Marine Biotoxins and Their Metabolites in Shellfish

Michal Godula, Thermo Fisher Scientific, Prague, Czech Republic

## Executive Summary

In recent years, many countries have had to deal with the negative effects of toxic microalgal blooms in both marine and fresh water, such as the death of wild animals and domestic livestock. The food most frequently involved in episodes of human poisoning are bivalve mollusks. As they filter large quantities of water for tropical reasons, these shellfish can accumulate and concentrate biotoxins present in the plankton they ingest.

There are a series of regulations issued by the regulatory agencies concerning the control of lipophilic toxins in bivalve mollusks destined to market for human consumption. In the past, bioassays on mice were predominantly used. However, liquid chromatography coupled with mass spectrometry (LC-MS) presents a viable alternative for today's analysts.

The purpose of this document is to describe possible alternatives for comprehensive analysis of marine biotoxins in various samples, applying LC-MS based on either a triple quadrupole mass spectrometer or a high-resolution accurate-mass mass spectrometer.



## Keywords

Marine Biotoxins, Exactive Plus, Orbitrap, Triple Quadrupole MS/MS, UHPLC

## Introduction

In recent years, many countries have had to deal with the negative effects of toxic microalgal blooms in both marine and fresh water, such as the death of wild animals and domestic livestock. Several cases of poisoning in humans have been associated with the direct consumption of shellfish, fish or water contaminated by algal toxins. People may also come into contact with toxins during recreational activities along sea coasts that are affected by episodes of algal blooms. Depending on the type of toxin involved, there are forms of mild and usually self-limiting symptoms, characterized by gastrointestinal disorders or allergy-like episodes. Much more severe neurological symptoms can lead to death of the affected person.

The foods most frequently involved in human poisoning are bivalve mollusks. When filtering large quantities of water for tropical reasons, these shellfish can accumulate and concentrate the biotoxins present in the plankton they ingest. Moreover, it is not possible to evaluate their edibility only by an organoleptic examination. While human ingestion of contaminated food with biotoxins can lead to the onset of different clinical symptoms, in shellfish they usually have only marginal effects. An important risk factor lies in the thermostability of such molecules, which are not completely inactivated by common physical treatments carried out on fish products (cooking, smoking, salting, freezing, housing) and remain virtually unchanged in the finished product.

There are a series of regulations issued by the European Union (EU) related to marine biotoxins. Regulation (EC) No 853/2004<sup>1</sup> concerns the control of lipophilic toxins, establishing maximum levels for lipophilic toxins in bivalve mollusks destined to the market for human consumption:

- For okadaic acid, dinophysistoxins and pectenotoxins together, 160 micrograms of okadaic acid equivalent per kilogram
- For yessotoxin, 1 milligram of yessotoxin equivalent per kilogram
- For azaspiracids, 160 micrograms of azaspiracids equivalent per kilogram

In the past, aside from bioassays on mice, most analytical techniques developed for the determination of marine biotoxins in bivalve mollusks have been based on offline methodologies, i.e. methods involving solid phase extraction (SPE) or liquid-liquid extraction (LLE) followed by high-pressure liquid chromatography (HPLC) with fluorometric or UV-diode array detection, or detection by liquid chromatography coupled with mass spectrometry (LC-MS).

The EU Commission Regulation (EC) No 15/2011,<sup>2</sup> amending Regulation (EC) No 2074/2005 about the testing methods for detecting marine biotoxins in bivalve molluscs, describes an LC-MS/MS procedure as the reference method for the quantification of lipophilic marine biotoxins, namely okadaic acid, pectenotoxin 2, azaspiracid 1, and yessotoxin. Moreover, dinophysistoxin 1 (DTX-1) and dinophysistoxin 2 (DTX-2) can be quantified by the calibration curve of okadaic acid, pectenotoxin 1 by the calibration of pectenotoxin 2, azaspiracid 2 and 3 by the calibration of azaspiracid 1 and 45-OH-, and 45-homo-OH-yessotoxin by the calibration of yessotoxin.

The purpose of this document is to describe the possible alternatives for analysis of marine biotoxins in various samples, applying LC-MS based either on triple quadrupole or high-resolution accurate-mass (HRAM) mass spectrometry (MS).

### **From Mouse Bioassay to Techniques of the 21st Century**

Besides the mouse bioassay test, triple quadrupole LC-MS/MS methods have been the most commonly used detection techniques for marine biotoxins, providing high sensitivity and selectivity. However, this technique requires detection of compounds that are pre-selected and fine tuning of system parameters in order to detect low concentrations in complex matrices. Despite the lack of capabilities to screen for larger number of compounds, unknown toxins or new metabolites of known substances, LC and UHPLC-MS/MS have been used successfully in many routine labs.

Recently, HRAM MS has introduced new advantages to residual analysis. Due to the fact the data acquisition is always performed in the full-scan mode, no special parameter setup or tuning for specific compounds is needed. The selectivity and sensitivity of the method is achieved via post-processing of the data using extraction of accurate mass data from the full scan records. By doing so, selectivity comparable to or better than with triple quadrupole LC-MS/MS technology is obtained.<sup>3</sup> In addition, post-processing allows for retrospective analysis in order to search for new, emerging toxins or their metabolites. It also helps to eliminate false positive and false negative results by providing additional, confirmatory information.

Several types of mass spectrometers operating at high resolving power and providing accurate mass information have been introduced in the past. The most recent and most advanced instruments are based on the Thermo Scientific™ Orbitrap™ mass analyzer, originally developed by Makarov and colleagues.<sup>4</sup> The improvements introduced by Orbitrap technology, such as ease of use, mass axis accuracy and stability, and ultra-high resolving power, have encouraged the adoption of HRAM systems even in routine laboratories.

## Moving to the Next Step Beyond Triple Quadrupole MS/MS Quantitation

The Thermo Scientific Application Note 63552<sup>5</sup> describes a quick and simple method for biotoxin analysis based on the EURL LC-MS protocol.<sup>6</sup> Utilizing offline sample preparation and determination by the Thermo Scientific™ TSQ Quantum Ultra™ triple quadrupole mass spectrometer, the method meets general performance criteria required for the analysis of lipophilic shellfish toxins. The simplicity of the method makes this approach suitable for any routine lab doing the analysis.

Figure 1 documents the selectivity of the method by showing the extracted ion chromatograms for the analyzed compounds at 40 µg/kg levels. As can be seen, the selectivity of the MS/MS mass spectrometer allows easy detection of all compounds at levels required by regulation.

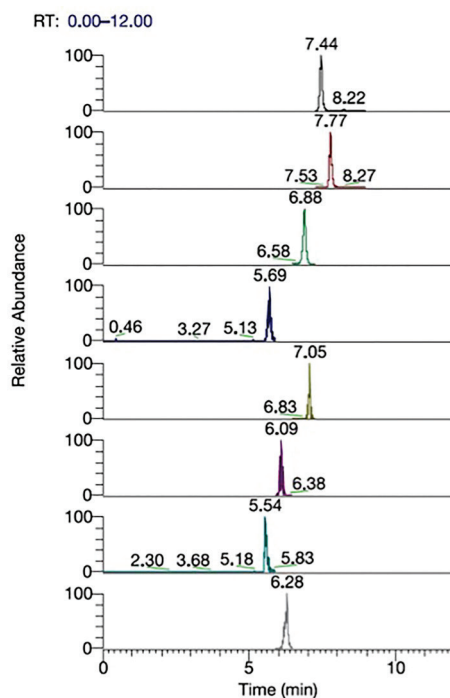

Figure 1. Chromatogram of sample containing 40 ppb of toxins, analyzed by TSQ Quantum Ultra quadrupole LC-MS (Retention Time: 7.44 min – AZA-1; 7.77 min – AZA-2; 6.88 min – AZA-3; 5.69 min – OA; 7.05 min – DTX-1; 6.06 min – DTX-2; 5.54 min – YTX; 6.28 min – PTX-2).

In general, the utilization of triple quadrupole LC-MS/MS is a viable solution for any lab performing targeted analysis of the well-defined groups of compounds. It is, however, not suitable for the analysis of a broader range of compounds, metabolites or conjugates for which the structural information is not known.

## Future Approaches: Accurate Mass Data

As already mentioned, in response to the need for non-targeted methods that can potentially detect unknowns, metabolites or adducts, HRAM has been successfully implemented for screening and quantification in food safety applications. The lower cost, higher mass accuracy, and ease-of-use of modern quadrupole time-of-flight (QTOF) and Orbitrap—based mass spectrometers have made high-resolution systems viable alternatives to triple quadrupole systems for routine analysis. After full-spectrum data acquisition, specificity is typically achieved by extracting narrow mass windows (ie. 2–5 ppm) centered around a list of target analytes. Using this approach, it has been demonstrated that a resolving power of 50,000 or greater is required for correct mass assignments in complex matrices.<sup>3</sup>

The Thermo Scientific Application Note 52154 describes the use of the Thermo Scientific™ Exactive™ Orbitrap mass spectrometer for screening lipophilic marine biotoxins commonly found in shellfish. The method was optimized using a standard mixture of marine biotoxins applied to mussel tissue extract. In summary, shellfish tissue was homogenized repeatedly with a mixture of methanol and water, centrifuged and directly analyzed by an Exactive Orbitrap LC-MS.<sup>7</sup> The LC-HRAM method was based on full scan data acquisition at 50,000 FWHM resolving power and alternating polarity that allowed simultaneous detection of both positive and negative ions.

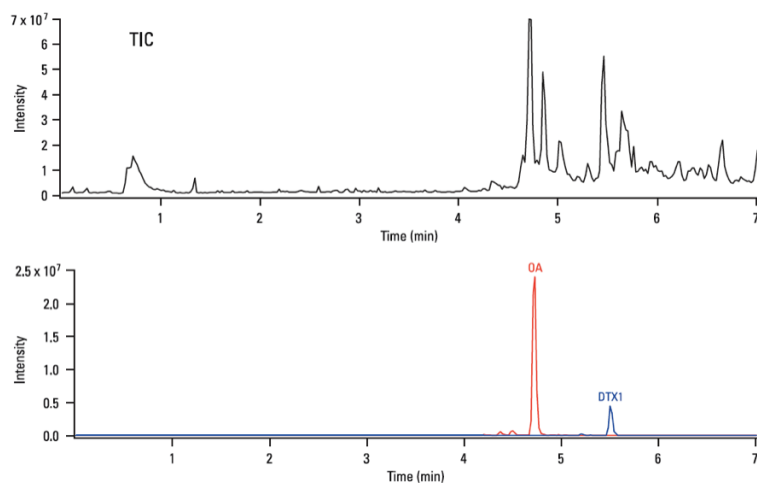

Figure 2. Exactive Orbitrap LC-MS analysis of a mussel tissue extract showing the total ion chromatogram (TIC; top trace) and 5 ppm mass chromatograms for okadaic acid and DTX1 (lower trace).

A similar approach was recently published by Domenech *et al*<sup>8</sup> in which the Exactive Orbitrap MS coupled to a Thermo Scientific™ Accela™ UHPLC system was used to determine a group of priority shellfish toxins in mussel samples. The researchers performed a detailed study on the application of a high-energy collision cell (HCD) to fragment precursor ions and obtain confirmatory information. The main aim of this study was to develop a method for the quantitative determination of lipophilic marine toxins using high-resolution (50,000 at  $m/z$  200 full width at half maximum – FWHM) and mass accuracy better than 5 ppm. Fragment and isotope ions and ion ratios were studied and evaluated for confirmation purposes. In-depth characterization of full scan and fragmentation spectrum of the main toxins were carried out. Moreover, the performance of the quantification method using HRAM was evaluated in a validation study. Validation parameters such as accuracy (trueness and precision), linearity, calibration curve check, limit of quantification (LOQ) and specificity were established for all the toxins.

As documented in Figure 3, obtaining both precursor and fragment ion chromatograms allowed scientists to provide enough confirmatory information to comply with EU analytical method quality criteria.<sup>9</sup> Additionally, during the study, researchers performed complete validation of the method and documented excellent performance in routine quantitative analysis.

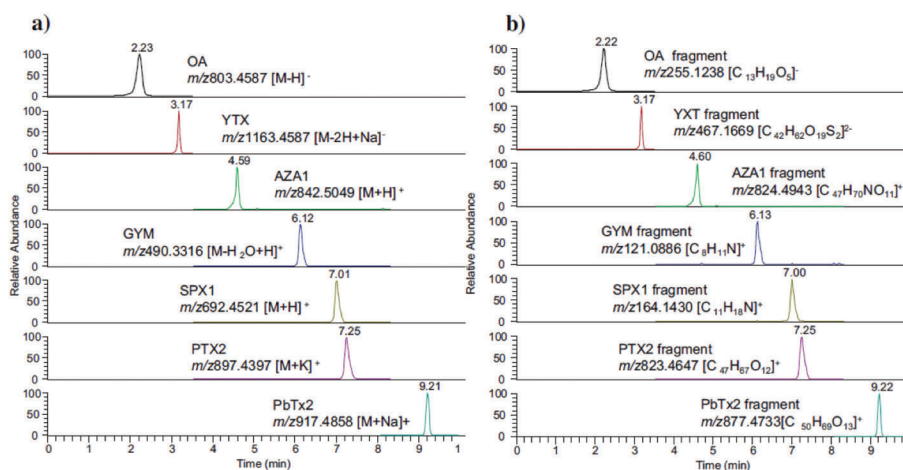

Figure 3. Extracted ion chromatogram of the lipophilic marine toxins, showing (a) diagnostic ions and (b) fragment ions, with an extraction window of 5 ppm.

However, the scope of the HRAM approach reaches far beyond the details discussed above. The acquisition of accurate mass spectra (MS and MS/MS) enables the creation of libraries that could be used for comprehensive toxin screening. As described in the work of Gerssen et al, the data obtained by the Thermo Scientific™ LTQ Orbitrap XL™ hybrid ion trap-Orbitrap mass spectrometer were processed and corresponding spectra were created.<sup>10</sup> The library contains information about compound name, accurate mass, mass deviation (<5 ppm), retention time (min) and retention time deviation (<0.2 min). Gerssen also documented a superior level of precision provided by the Orbitrap MS compared to a TOF technique when screening for compounds by using accurate mass. As can be seen in Figure 4, mass error deviation is almost an order of magnitude lower when the Orbitrap MS is used. This drastic difference in results is related to the fact that, when screening for compounds by using accurate mass, usually a data extraction window of  $\pm 5$  ppm is used. High errors observed in TOF data don't usually allow the application of such a narrow window, which subsequently negatively influences selectivity of TOF instruments.

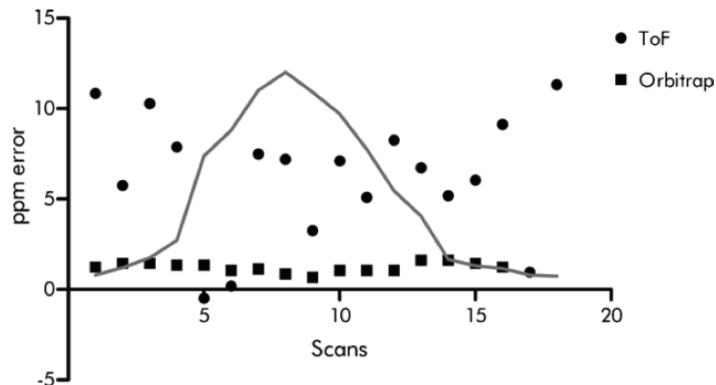

Figure 4. Mass error observed within a chromatographic peak of AZA1 recorded by Time-of-Flight (ToF) and Orbitrap MS. Reprinted with permission from: Giessen *et al.* *Analytica Chimica Acta* 685 (2011) 176–185.

An interesting approach that challenges the capabilities of the technique has been presented by Ciminiello *et al.*<sup>11</sup> The group used the LTQ Orbitrap XL MS to identify new types of large molecular weight toxins belonging to groups produced by *Ostreopsis ovata*. Ovatoxins and palytoxin are compounds with molecular weights of >2000 Da, which makes them very difficult to detect by conventional triple quadrupole mass spectrometers, which usually have a mass range below 2000 Da. Using a linear ion trap combined with an Orbitrap mass analyzer allowed scientists to detect accurate masses of precursors of toxins as well as to perform structural elucidation and provide fragmentation pathways with accurate mass information. This approach allowed them to identify new structural analogues and to quantify those analogues in order to assess the typical profile of *O. ovata* strain metabolites.

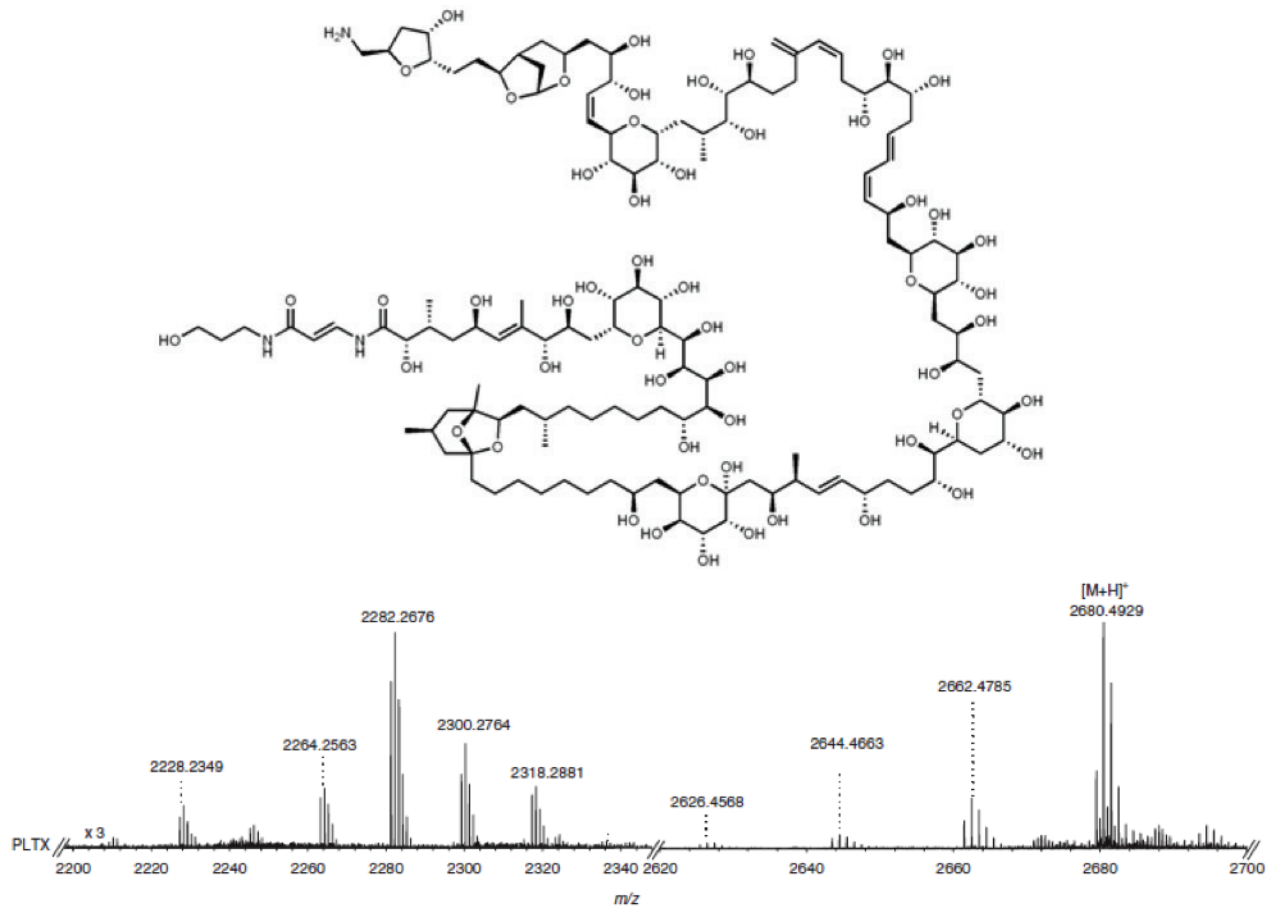

Figure 5. Structure of palytoxin (PLTX) with cleavage and example of mass spectra of palytoxin documenting the high molecular weight nature of the novel types of compounds. Reprinted with permission from: Ciminiello *et al*; Rapid Commun. Mass Spectrom. 24 (2010) 2735–2744.

### Business Benefits

As summarized above, there are different approaches to the analysis of shellfish toxins in seafood samples. The traditional mouse bioassay has the clear advantage of providing direct toxicological response. However, the need for specific strains of laboratory mice to perform the test, the potential to build a resistance against toxins, and the unavoidable “cruelty” of the method make this approach the method of the past. Analytical scientists have been searching for alternatives and, although mass spectrometry based on targeted triple quadrupole MS/MS is a very sensitive and quantitative technique, it does not deliver the complete answer. The potential risk of missing a toxin due to a targeted approach creates the need for more comprehensive methods.

From this perspective, there are several benefits of using HRAM technology instead of triple quadrupole MS/MS. The ability to perform screening, quantitation and confirmation in one run combined with unequivocal selectivity and required detection limits that can be achieved make HRAM the key approach for future testing. The inherent possibility to search for a theoretically unlimited number of compounds makes the method easy to expand and develop. The unique properties of full scan accurate mass acquisition allow researchers to search for structural analogues of most emerging toxins, their metabolites or adducts, many of which may pose toxicologically relevant effects.

## Conclusion

LC-MS is the key technique to be applied in qualitative and quantitative analysis of shellfish toxins in foods.

Triple quadrupole mass spectrometry presents the traditional approach with benefits of affordability, robustness, simplicity and applicability in many routine laboratories.

HRAM MS, especially if performed on instruments using an Orbitrap mass analyzer, presents a state-of-the-art alternative to triple quadrupole MS. The possibility to perform screening, quantitation and confirmation of an almost unlimited number of compounds in one run improves lab throughput and lowers the cost per test. At the same time, the data provided by high resolution instruments allow retrospective analysis.

In the research labs, the possibility to perform complete identification of the new toxins, their analogues or metabolites opens new areas of research. High-quality MS data obtained by novel hybrid Orbitrap mass analyzers such as the Thermo Scientific™ Q Exactive™ Plus mass spectrometer or Thermo Scientific™ Orbitrap Fusion™ Tribrid™ mass spectrometer provide scientists a great tool in this very challenging and interesting area of research. The mass accuracy and stability provided by the new generation of instruments along with ultra-high resolving power deliver unprecedented confidence in data quality—compared to triple quadrupole or TOF-based MS systems. The flexibility of both instruments then allows users to collect both quantitative and qualitative data in a single run and to accelerate the delivery of results both in routine and research labs.

## Supporting Material

Application notes 63552 and 52154

## References and Acknowledgements

1. European Parliament, Regulation 853/2004/EC, *Off. J. Eur. Common.* 2004, 139, 55.
2. European Commission, Commission Regulation 15/2011/EC, *Off. J. Eur. Common.* 2011, 279, 5.
3. Kaufmann *et al*, *Analytical Chemical Act* 2010, Volume 673, Issue 1, 60-72.
4. A.A. Makarov, 'Electrostatic Axially Harmonic Orbital Trapping: A High-performance Technique of Mass Analysis', *Anal. Chem.* 2000, 72, 1156–1162.
5. Application Note 63552: Determination of Lipophilic Marine Biotoxins in Mollusks by LC-MS/MS using Offline Extraction, *Thermo Fisher Scientific* 2013.
6. European Union Reference Laboratory for Marine Biotoxins, *EU-RL-MB SOP* 2011, Version 4.
7. Application Note 52154: Non-Targeted Screening of Lipophilic Marine Biotoxins by Liquid Chromatography – High-Resolution Mass Spectrometry, *Thermo Fisher Scientific* 2011.
8. Domenech *et al*, *Journal of Chromatography A* 2014, Volume 1328, 16–25.
9. European Commission, 2002/657/EC, *Off. J. Eur. Common.* 2002, 221.
10. Giessen *et al*. *Analytica Chimica Acta* 2011, 685, 176–185.
11. Ciminiello *et al*; *Rapid Commun. Mass Spectrom.* 2010, 24, 2735–2744.

[www.thermofisher.com](http://www.thermofisher.com)

©2016 Thermo Fisher Scientific Inc. All rights reserved. All trademarks are the property of Thermo Fisher Scientific, Inc. and its subsidiaries. Specifications, terms and pricing are subject to change. Not all products are available in all countries. Please consult your local sales representative for details.

**Africa** +43 1 333 50 34 0

**Australia** +61 3 9757 4300

**Austria** +43 810 282 206

**Belgium** +32 53 73 42 41

**Canada** +1 800 530 8447

**China** 800 810 5118 (free call domestic)  
400 650 5118

**Denmark** +45 70 23 62 60

**Europe-Other** +43 1 333 50 34 0

**Finland** +358 9 3291 0200

**France** +33 1 60 92 48 00

**Germany** +49 6103 408 1014

**India** +91 22 6742 9494

**Italy** +39 02 950 591

**Japan** +81 45 453 9100

**Latin America** +1 561 688 8700

**Middle East** +43 1 333 50 34 0

**Netherlands** +31 76 579 55 55

**New Zealand** +64 9 980 6700

**Norway** +46 8 556 468 00

**Russia/CIS** +43 1 333 50 34 0

**Singapore** +65 6289 1190

**Spain** +34 914 845 965

**Sweden** +46 8 556 468 00

**Switzerland** +41 61 716 77 00

**UK** +44 1442 233555

**USA** +1 800 532 4752

**Thermo**  
SCIENTIFIC

A Thermo Fisher Scientific Brand





# Fast and Accurate Determination of Algal Toxins in Water Using Online Preconcentration and UHPLC-Orbitrap Mass Spectrometry

Jaewon Choi,<sup>1</sup> Je-Heon Jang,<sup>1</sup> Jennifer Massi,<sup>2</sup> Jonathan Beck<sup>2</sup>

<sup>1</sup>Water Analysis & Research Center, K water, Daejeon 306-711, Korea

<sup>2</sup>Thermo Fisher Scientific, San Jose, CA, USA

## Key Words

EQuan, Exactive, Orbitrap, algal toxins, cyanobacteria, water analysis, online concentration

## Goal

To develop a column-switching technique based on online preconcentration and high-resolution, full-scan Thermo Scientific™ Orbitrap™ mass spectrometry to obtain fast and accurate results for the determination of algal toxins in drinking water.

## Introduction

When the density of the colonies of *Microcystis* and *Nodularia* cyanobacteria surpass a certain level, they produce hepatotoxic substances called microcystins and nodularins, respectively,<sup>2</sup> while *Anabaena* and *Aphanizomenon* are known to produce a neurotoxin called anatoxin.<sup>3</sup> These toxins can cause deaths of wild animals and domestic livestock. Human poisoning can lead to gastrointestinal and allergy-like reactions and, in rare occasions, death. Of the cyanobacteria species, *Microcystis* has been observed to be dominant in the majority of eutrophication events. Microcystins, the toxins it produces, are cyclic peptides comprised of seven amino acids, each with a relatively large molecular mass ranging from 900 to 1,100 Da. There are approximately 60 to 85 variants of microcystins reported to date (Figure 1).<sup>4,5</sup> Moreover, nodularins produced by *Nodularia* are peptide-based hepatotoxins similar to microcystins.

According to the World Health Organization (WHO), microcystins are chemically stable and can have an adverse impact on human health if present in a water supply source.<sup>1</sup> Prior research has shown that the microcystins -YR, -RR, and -LR (Figure 1) are the most common isomers detected, and that microcystin-LR is the most toxic. Based on these results, the WHO has set forth a water quality guideline specifying that the microcystin-LR concentration be maintained below 1 ng/mL. This guideline is currently being used in Korea as part of a candidate list for drinking water standards.

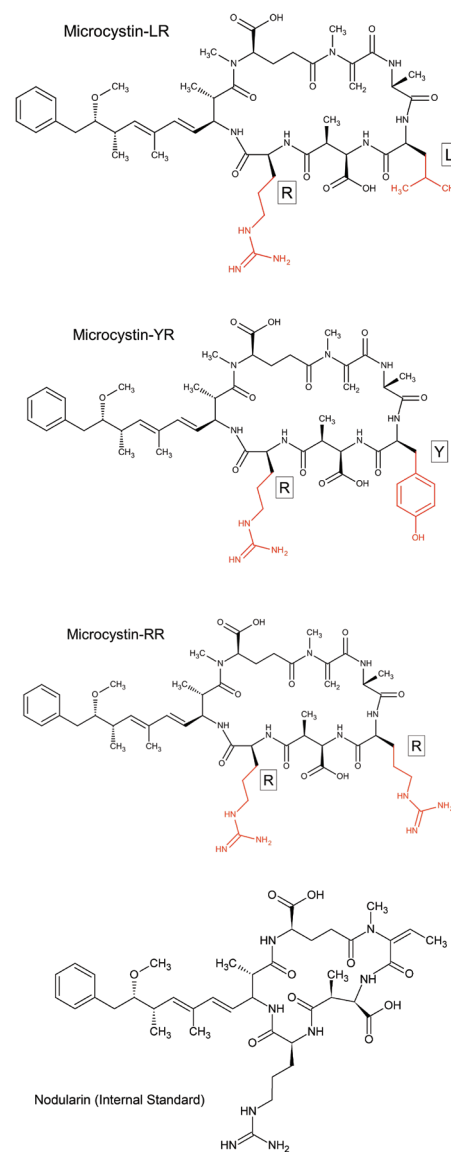

Figure 1. Structures of the cyclic peptide microcystins and nodularin

In Korea, when an algal bloom is forecasted, samples from the water supply source are collected and the chlorophyll-a concentration and the cyanobacteria cell number are measured. Based on the results, the situation is categorized into one of the following situations: ‘algal bloom watch,’ ‘algal bloom alert,’ or ‘algal bloom.’ In the latter two situations, the cyanotoxins, mainly microcystin-LR, are analyzed.<sup>6</sup> Accurate analysis of multiple samples within a short time is required in order to monitor the multiple points of the water supply source and each of the processes taking place at water purification plants.

Traditionally, cyanotoxins have been measured by performing extraction and concentration through solid-phase extraction (SPE) followed by high-performance liquid chromatography with ultraviolet detection (HPLC/UVD) or photodiode array detection. More recently, the analysis time has been reduced and the sensitivity improved through the use of liquid chromatography–mass spectrometry (LC-MS/MS) applying electrospray ionization (ESI).<sup>7-13</sup> The conventional SPE process required for all of these methods uses a great deal of time and solvent.

An online preconcentration and injection method can shorten the sample pretreatment process and help detect trace amounts of target substances, while an Orbitrap-type high-resolution mass spectrometry method takes into account the retrospective aspect of data, making possible both accurate identification of the analyzed toxins and post-process quantitation of microcystin isomers. Therefore, we combined these two techniques for the identification and quantitation of microcystin-RR, -YR and -LR as well as nodularin. Then, an optimized method was developed to enhance the reliability and economic efficiency by reducing the run time and the amount of solvent necessary. The method was applied to raw and treated water from water purification plants and river systems.

## Experimental

### Reagents

Microcystin-LR, RR, and YR were procured from Wako Pure Chemical Industries, Ltd. (Tokyo, Japan) in a dried crystal form. Nodularin was procured from Cayman Chemical (CA, USA) in a dissolved form (500 µg in 500 µL of ethanol).

Information on each of the standard materials is summarized in Table 1. Solvents were of residual pesticide grade. Water was double distilled by reverse osmosis.

### Standard Solutions and Calibration Curves

The standard solutions containing the cyanotoxins were prepared by dissolving microcystin-LR, -RR, and -YR into methanol at 100 µg/mL and by dissolving nodularin in ethanol to a concentration of 10 µg/mL. Solutions were stored in a cold room at 4 °C. Taking into consideration the sensitivity of the analysis method and the WHO guideline of a microcystin-LR concentration of 1 ng/mL, the solutions were diluted into six different concentrations within the range of 100 to 1000 pg/mL. An external standard method was used for calibration curve verification and sample identification. Then, the ratio of peak areas according to the concentration of standard solution were calculated.

### Sample Collection and Storage

A total of 173 raw and treated water samples were collected from 59 facilities at the Han (18 sites), Nakdong (18 sites), and Geum-Seomjin (19 sites) Rivers, and in the city of Geoje (4 sites), as well as 55 sites in the Han River basin measurement network area. All samples were refrigerated during transport, transferred directly to a cold room in the lab, and maintained at 4 °C. Sample aliquots were analyzed within three days of delivery.

### Pretreatment and Instrumental Analysis

Online preconcentration using column switching was applied as a means to minimize sample pre-treatment and shorten analysis time. A Thermo Scientific™ EQUAN MAX™ online sample concentration UHPLC-MS system equipped with a Thermo Scientific™ Hypersil GOLD aQ™ preconcentration column (20 × 2.1 mm, 12 µm particle size) and a Thermo Scientific™ Hypersil GOLD™ analytical column (50 × 2.1 mm, 1.9 µm particle size) was used. The allowable liquid sample injection range was 1 to 20 mL, and in this study the sample injection amount was set at 1 mL after considering the WHO guideline, equipment sensitivity, peak shape, and concentration ratio of the online injection. The standard material for the calibration curve and all the samples used in the analysis were filtered through a 0.45 µm glass fiber (GF) membrane syringe filter.

A Thermo Scientific™ Exactive™ Orbitrap mass spectrometer was operated in full-scan mode. Resolving power was set to 50,000 (FWHM at  $m/z$  200). The detailed conditions for the online sample concentration and injection and the operation of the Orbitrap mass spectrometer are summarized in Tables 2 and 3, respectively. For the post-analysis identification and quantitation, an external standard method was applied.

Table 1. Chemical formula and molecular weight of target algal toxins

Compound	Name (CAS)	Formula	Molecular Weight
Microcystin	Microcystin-LR (101043-37-2)	C <sub>49</sub> H <sub>67</sub> N <sub>10</sub> O <sub>12</sub>	995.1717
	Microcystin-RR (111775-37-4)	C <sub>49</sub> H <sub>75</sub> N <sub>13</sub> O <sub>12</sub>	1038.1997
	Microcystin-YR (101064-48-6)	C <sub>52</sub> H <sub>72</sub> N <sub>10</sub> O <sub>13</sub>	1045.1873
Nodularin	Nodularin (118399-22-7)	C <sub>41</sub> H <sub>60</sub> N <sub>8</sub> O <sub>10</sub>	824.9627

Pump 1				Pump 2			
Hypersil GOLD aQ (preconcentration column)				Hypersil GOLD (analytical column)			
Time	%A	%B	$\mu\text{L}/\text{min}$	Time	%A	%B	$\mu\text{L}/\text{min}$
0.00	98	2	1000	0.00	98	2	400
1.01	98	2	1000	1.00	98	2	400
1.20	98	2	100	2.00	2	98	400
3.50	98	2	100	3.50	2	98	400
4.00	98	2	1000	3.51	98	2	400
				4.00	98	2	400
Mobile phase A: 0.1% formic acid in water B: acetonitrile				Mobile phase A: 0.1% formic acid in water B: acetonitrile			
Column temperature: Ambient							
Injection volume: 1000 $\mu\text{L}$							

Table 3. Exactive Orbitrap MS operating conditions

Parameter	Setting
Scan range	$m/z$ 150–1100
Resolving power	50,000 (FWHM at $m/z$ 200)
Polarity	Positive
Measured $m/z$	995.5543 MC-LR 519.7898 MC-RR 1045.5344 MC-YR 825.4501 Nodularin
Ionization source	Electrospray
Spray voltage	4000 V
Capillary temperature	340 °C
Capillary voltage	37 V
Tube lens voltage	85 V
Skimmer voltage	22 V

## Results and Discussion

### High-Resolution Mass Spectra of Toxins

The standards were prepared at a concentration of 1 ng/mL each and injected using a syringe pump to observe the mass spectra. The molecular ion and carbon isotope spectra of microcystin-LR, -RR, -YR, and nodularin are shown in Figure 2a. Four carbon isotopes were observed for most compounds. Using this isotopic pattern, it was possible to match the experimentally recorded carbon isotopic distribution ratios to the theoretical isotopic ratio to provide confirmation of the toxin using the analysis software. Meanwhile, molecular ions were observed in nodularin at  $m/z$  825 and the isotopic pattern was confirmed (Figure 2b).

A

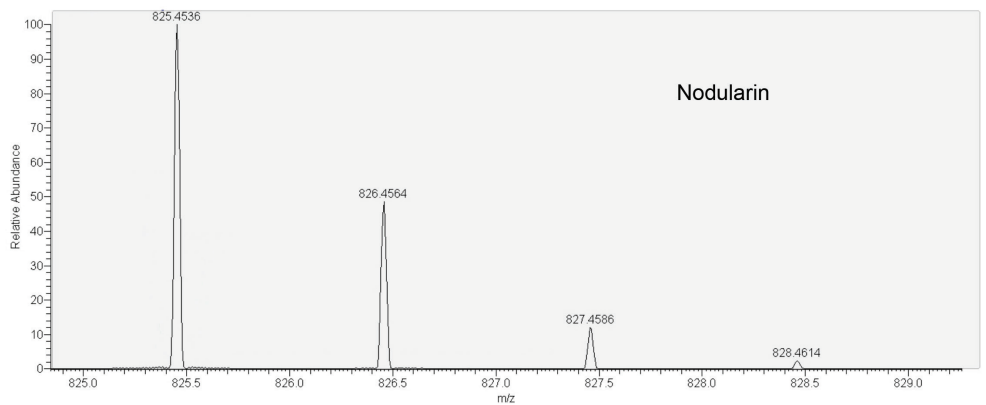
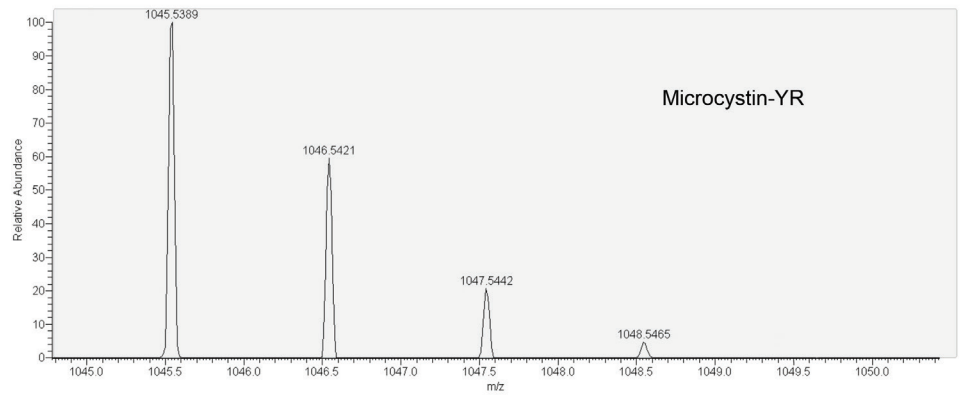
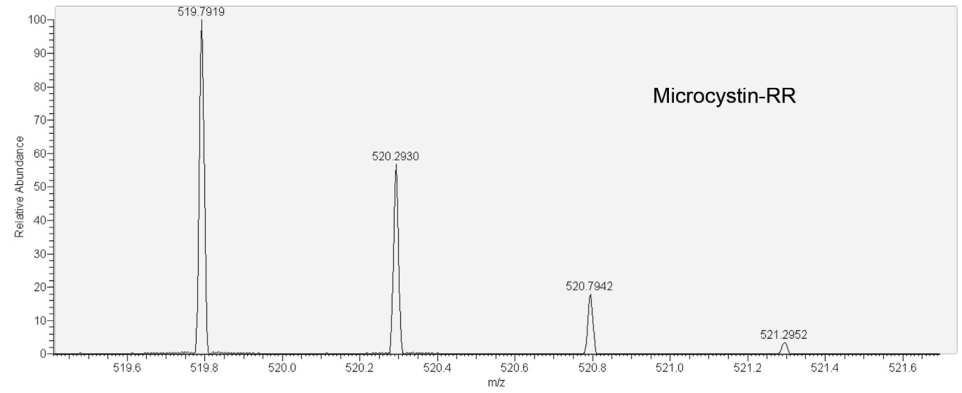
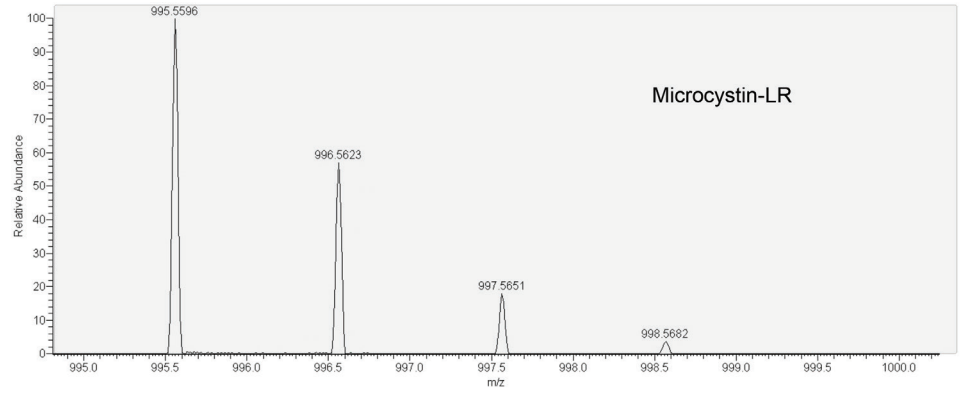

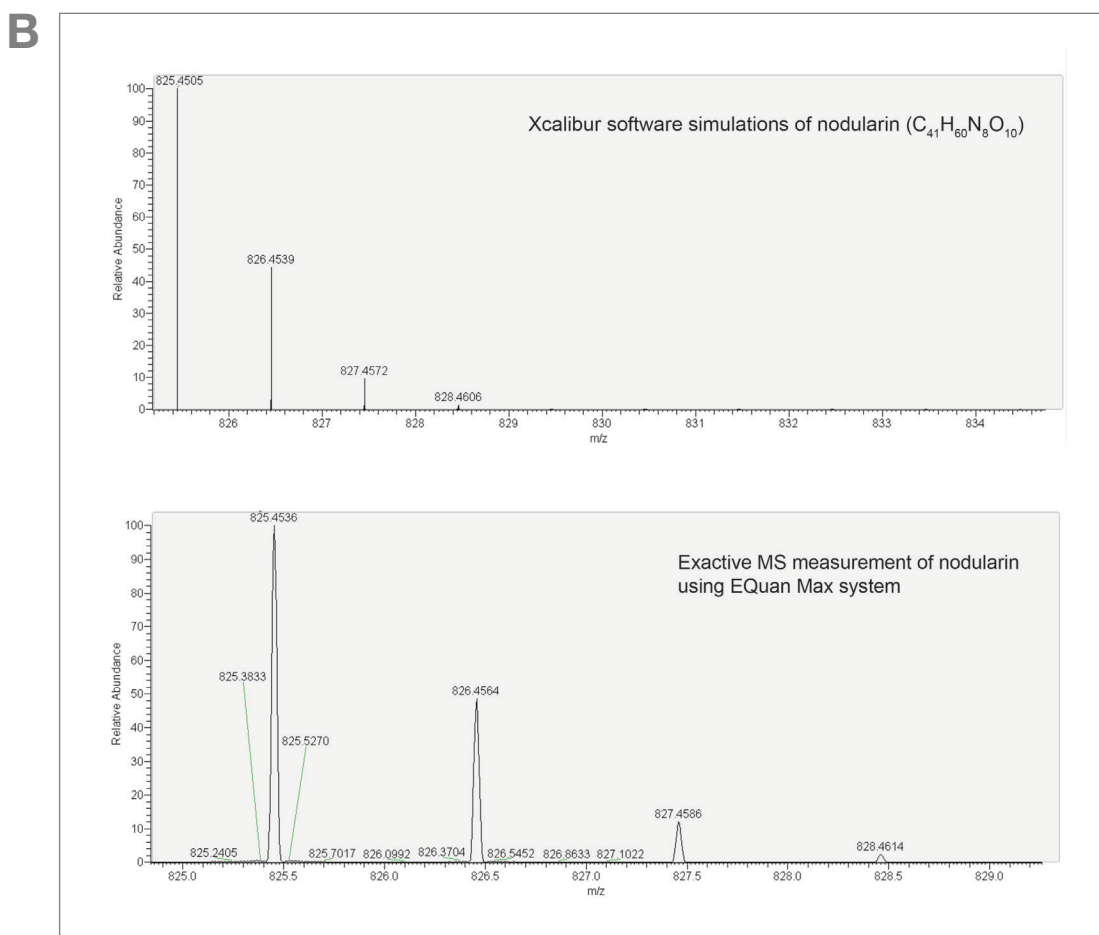

Figure 2. A) Carbon isotope patterns by high-resolution, full-scan MS of microcystins and nodularin, and B) simulated spectrum of nodularin (top) compared to actual spectrum (bottom), confirming isotope pattern.

From the results of the syringe injection, the quantitation ions for microcystins -LR, -RR, and YR and nodularin were set at 995.5543, 519.7898, 1045.5344, and 825.4501, respectively. In addition, the scanning range for identification and quantitation of the target compounds was between  $m/z$  400 and 1100 for simultaneous analysis. However, the minimum range was set at  $m/z$  150 to allow confirmation and quantitation of various algal toxins, such as anatoxin generated by *Anabaena*, which occurs just as frequently during an algal bloom.

### Optimization of the Online Preconcentration Method

In this study, 1 mL of each sample was used for the online preconcentration method. During the five minute analysis, adsorption and mobilization of the target toxin and column separation were carried out under the gradient conditions shown in Table 2. First, an injection of 1 mL of sample when the 0.1% formic acid and water/acetonitrile ratio was 98:2 led to the target toxin being adsorbed in the front part of the trap column and the remainder of the water sample being diverted to waste. The valve was then switched to position 2 for elution from the SPE column onto the analytical column using 98% acetonitrile. A summary of the analysis flow, including online SPE, is shown in Figure 3.

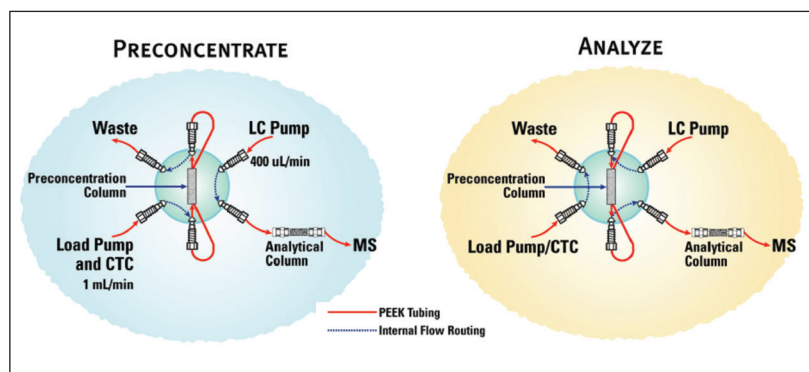

Figure 3. Switching column method for on-line sample injection

A comparison of the absolute amount introduced into the mass spectrometer comparing online and offline SPE shows that online SPE has the same concentration-injection effect as pretreating and concentrating a 200 mL sample into 2 mL and injecting 5  $\mu$ L of the pre-concentrated sample. Thus, it is possible to perform a direct injection, online SPE with small volumes microanalysis without a separate using a large offline, pretreatment step. Also, this method uses UPLC-based chromatography and sharp peaks are obtained, as shown in Figure 4.

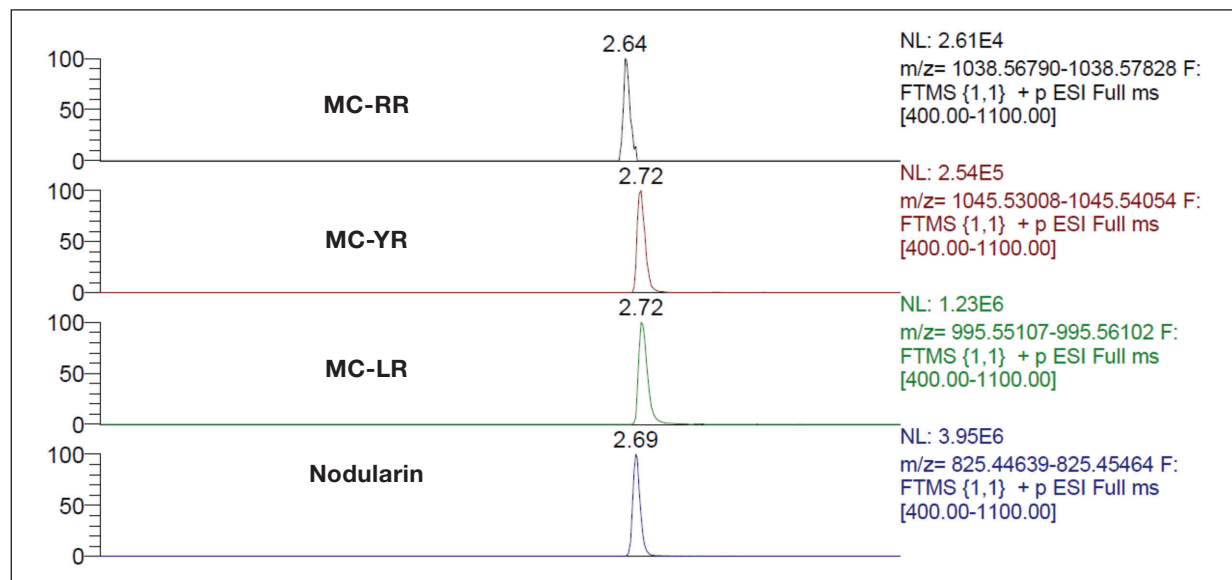

Figure 4. Extracted chromatograms from full-scan data by UHPLC-Orbitrap mass spectrometer

A comparison of the absolute amount introduced into the mass spectrometer using this online method and offline SPE shows that the online method has the same concentration-injection effect as pretreating and concentrating a 200 mL sample into 2 mL using offline SPE and injecting 5  $\mu$ L of the pre-concentrated sample. Thus, it is possible to perform a microanalysis without a separate pretreatment. Also, this method uses UPLC-based chromatography and sharp peaks are obtained, as shown in Figure 4.

The retention times for microcystin-LR, -RR, and -YR and nodularin using this method were between 2.6 and 2.8 min. Due to the application of a relatively short column and a simple solvent combination, mass separation occurs under high-resolution conditions at a resolving power of 50,000. Therefore, even if there is an overlap of retention times, identification and quantitation based on the difference of the precise mass unique to each of the toxins is possible as shown in Table 3. Thus, there was no actual interference between the toxins (Figure 4).

Compared to the conventional SPE method, which requires the use of 0.5 to 1 L sample, the online injection method effectively reduced the analysis time and amount of sample required. In a typical analysis with five samples, a conventional SPE method would require 8 hours for the filtration, solid-phase extraction, and concentration processes; 2.3 hours for instrumental analysis; and 1 hour for data analysis and quantitation, for a total of 12.3 hours. In contrast, the optimized method developed in this study required 10 minutes for sample division and filtration,

0.8 hours for instrumental analysis with the application of UHPLC, and the same amount of time for data analysis and quantitation, for a total of 2 hours. This is an 80% time savings. Other benefits of using this rapid pretreatment method include enhanced productivity when there is a large amount of sample, reduced use of organic solvents, reduced labor for the pretreatment process, and omission of a nitrogen concentration apparatus.

#### Calibration Curve Assessment

To review the linearity, the calibration curve of the standard toxin mixture of microcystin -LR, -RR, and -YR and nodularin was measured repeatedly within the range 100 to 1,000 pg/mL. As shown in Figure 5, the correlation coefficient for each of the toxins was between 0.9971 and 0.9996. Reproducibility was  $\pm 15\%$ . This is an improvement compared to the quantitation range for algal toxins in the water quality test samples reported.<sup>13</sup> Also, it was deemed possible to perform a linearity assessment at lower concentrations if necessary in the future since the signal-to-noise ratio (S/N) was sufficient at the minimum concentration of 0.1 ng/mL. Thus, based on these results, we determined that the online preconcentration high-resolution full-scan MS method has the equivalent trace quantitation capacity as the conventional method of solid-phase extraction and LC-MS/MS.



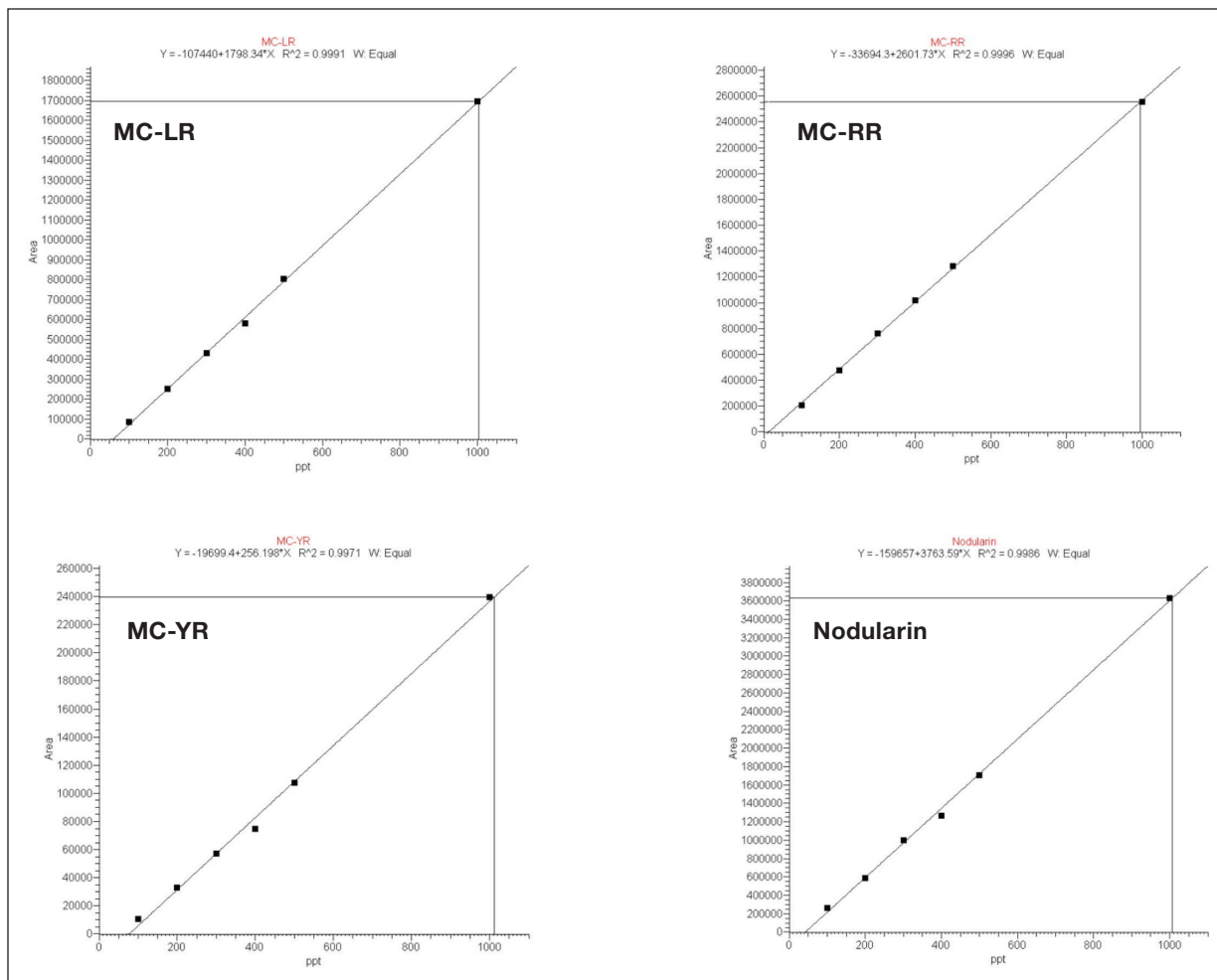

Figure 5. Calibration curve of microcystin-LR, RR, YR and nodularin

### Recovery Rate and Detection Limit

To assess the recovery rate of the optimized method, seven 20 mL samples were taken from the 1 L sample of the raw water collected from the Daecheong Dam in which the target toxins were not detected. Then, microcystin-LR, -RR, and -YR and nodularin were added to prepare a solution with 0.1 ng/mL of each. The solution was then filtered through the 0.45  $\mu\text{m}$  glass fiber filter and repeated analyses were conducted to measure the recovery rate for each toxin. As shown in Table 4, the recovery rates for microcystin-LR, -RR, and -YR and nodularin were 113.7%, 70.3%, 103.7%, and 83.9%, respectively. The recovery rates for the three types of microcystin toxins in the conventional SPE method were reported to be 70% to 110%.<sup>13,14</sup> Also, as shown in Table 4, the degree of precision of this method was calculated to be 2.5-10.9%. The method detection limit (MDL) was 0.009-0.035 ng/mL and the practical quantitation limit (PQL) was 0.15-0.51 ng/mL. The MDL set forth in the WHO guidelines with respect to microcystin-LR is a hundred times higher than what was achieved. These results are well below the guidelines set forth for microcystin-LR, such as 1 ng/mL in Australia, 0.3 ng/mL in Japan, 0.5 ng/mL in Canada, and 1 ng/mL by WHO.

Compound	Fortified Amount (µg/L)	MDL (µg/L)	PQL (µg/L)	Recovery (%)	RSD (%)
Microcystin-LR	0.1	0.009	0.03	113.7	2.5
Microcystin-RR	0.1	0.013	0.04	70.3	5.3
Microcystin-YR	0.1	0.035	0.11	103.7	10.9
Nodularin	0.1	0.009	0.03	83.9	3.7

MDL:  $SD \times t = SD \times 3.14$ , ( $n=7$ ,  $1-\alpha=0.99$ ), PQL:  $SD \times 10$

(Ref: Standard Methods 20th Edition, 1030C Method Detection Level)

### Application to Environmental Samples

The method was used on the samples collected from the water purification facilities. The raw water and river water samples were treated in an ultrasonic extraction apparatus for 30 min before being filtered through a 0.45 µm glass fiber filter. Also, one sample of cyanobacteria from lake water that was separately stored was analyzed. The four target algal toxins detected in the raw and treated water from the water purification facilities and the river water were well below the quantitation limit and were considered to be not detected. On the other hand, molecular ions of microcystin-LR were detected in cyanobacteria lake water sample and were identified through a comparison of the mass spectrum ratio of the carbon isotope of the standard toxin (Figure 2). It took approximately 16 hours to complete the calibration curve and analysis of the blank sample and all the samples. It was determined that the method could be used to rapidly analyze a large number of samples, to reduce the amount of labor and solvent necessary, and to contribute to making quick responses in the field.

### Conclusion

It is difficult to forecast algal blooms; therefore, rapid diagnosis of cyanotoxins produced by cyanobacteria is an important element in making quick responses at water intake and purification facilities. In this study, a combination of the online pre-concentration and injection method and the high-resolution, full-scan mass spectrometry method was used to assess algal toxins including microcystin-LR and applied to environmental samples. Based on the results, the following conclusions were reached:

- Microanalysis can be performed without a complex pretreatment procedure. The online preconcentration method produces 200 times the concentration effect compared to the solid-phase extraction method, even with a small sample of 1 mL. When combined with the high-resolution, full-scan mass spectrometry method, the method produced a linearity that was equivalent to that of the SPE and LC-MS/MS method. The recovery rate was over 70% and the degree of precision was within 10%. At the same time, the method detection limit (MDL) and the practical quantitation limit (PQL) were determined to be 0.009-0.035 ng/mL and 0.03-0.11 ng/mL, respectively. Based on these results, it was deemed to have the same performance as the conventional method.
- The application of the online preconcentration method decreased the analysis time by 80% compared to the conventional method and also reduced the amount of labor, solvent, and solid-phase cartridge cost required. Productivity was further enhanced with more samples and, thus, it is expected to substantially improve economic efficiency.
- Combining the instrumental analysis with the use of high-resolution, full-scan mass spectrometry makes it possible to detect non-target compounds. Thus, this method could be utilized for retrospective search and simultaneous quantitation of algal toxins with similar physicochemical properties such as anatoxin (mol. wt.: 165) and aplysiatoxin (mol. wt.: 672).

## References

1. WHO, *Toxic Cyanobacteria in Water, A Guide to Their Public Health Consequences, Monitoring and Management*, 1999, pp. 163-164.
2. Henriksen, A. S. and Olli, K. Sedimentation and Buoyancy of *Aphanizomenon cf. flos-aquac* (Nostocales, Cyanophyta) in a Nutrient-Replete and Nutrient-Depleted Coastal Area of the Baltic Sea, *Phycologia*, 1996, 35, 94-101.
3. Repavich, W. M.; Meisner, L. F.; Sonzogni, W. C.; Standridge, J. H.; and Wedepohl, R. E. Cyanobacteria (blue-green algae) in Wisconsin Waters: Acute and Chronic Toxicity, *Water Research*, 1990, 24, 225-231.
4. Lee, J. J.; Kim, H. B.; Moon, J. S.; Lee, J. A.; Lee, H. J.; Park, H. K.; Park, J. H.; Seo, J. K. Assessment of Microcystin Analysis Methods for Convenient Monitoring, Korean Society of Water (Fall 2010 Conference), 643-644.
5. Sivonen, K., Cyanobacterial Toxins. *Encyclopedia of Microbiology*, 3rd ed., 2009, pp. 290-307.
6. Jang, Je-Heon; Kim, Yun-Seok; Choi, Jae-Won, *Journal of Korean Society on Water Environment*, 2012, 28(6), 843-850.
7. Lawton, L. A.; Codd, G. A.; Edwards, C. Extraction and High-Performance Liquid Chromatographic Method for the Determination of Microcystins in Raw and Treated Waters, *Analyst*, 1994, 119, 1525-1530.
8. Harada, K.; Matsuura, K.; Suzuki, M. Analysis and Purification of Toxic Peptides from Cyanobacteria by Reversed-Phase High-Performance Liquid Chromatography, *Journal of Chromatography A*, 1988, 448, 275-283.
9. Yu, S. J.; Han, E. Y.; Hwang, J. Y.; Ryu, J. K.; Yoon, Y. S. Analysis of Microcystins in Daecheong Reservoir using High-Performance Liquid Chromatography, *Journal of Korean Society on Water Environment*, 1999, 15(4), 517-526.
10. Petrovic, M.; Barcelo, D.; and Tavazzi, S. Column-switching System with Restricted Access Pre-column Packing for an Integrated Sample Cleanup and Liquid Chromatographic - Mass Spectrometric Analysis of Alkylphenolic Compounds and Steroid Sex Hormones in Sediment, *Journal of Chromatography A*, 2002, 971(20), 37-45.
11. Zweigenbaum, J. A.; Beattie, K. A.; Codd, G. K.; Henion, J. D. Direct Analysis of Microcystins by Microbore Liquid Chromatography Electrospray Ionization Ion-trap Tandem Mass Spectrometry, *Journal of Pharmaceutical and Biomedical Analysis*, 2000, 23(4), 723-733.
12. Cong, L.; Chena, Q.; Huang, B.; Lu, B.; Ren, Y.; Zhang, J. Determination of Trace Amount of Microcystins in Water Samples using Liquid Chromatography Coupled with Triple Quadrupole Mass Spectrometry, *Analytica Chimica Acta*, 2006, 569(31), 157-168.
13. Kim, J. H.; Kim, H. C.; Yun, M. A. Method for Simultaneous Determination of Cyanotoxins in Water by LC-MS/MS, *Journal of Korean Society on Water Environment*, 2009, 25(4), 597-605.
14. Fastner, J.; Flieger, I.; Neumann, U. Optimized Extraction of Microcystins from Field Samples a Comparison of Different Solvents and Procedures, *Water Research*, 1998, 32(10), 3177-3181.

[www.thermofisher.com](http://www.thermofisher.com)

©2016 Thermo Fisher Scientific Inc. All rights reserved. All trademarks are the property of Thermo Fisher Scientific and its subsidiaries. This information is presented as an example of the capabilities of Thermo Fisher Scientific products. It is not intended to encourage use of these products in any manners that might infringe the intellectual property rights of others. Specifications, terms and pricing are subject to change. Not all products are available in all countries. Please consult your local sales representative for details.

**Africa** +43 1 333 50 34 0  
**Australia** +61 3 9757 4300  
**Austria** +43 810 282 206  
**Belgium** +32 53 73 42 41  
**Canada** +1 800 530 8447  
**China** 800 810 5118 (free call domestic)  
 400 650 5118

**Denmark** +45 70 23 62 60  
**Europe-Other** +43 1 333 50 34 0  
**Finland** +358 9 3291 0200  
**France** +33 1 60 92 48 00  
**Germany** +49 6103 408 1014  
**India** +91 22 6742 9494  
**Italy** +39 02 950 591

**Japan** +81 45 453 9100  
**Latin America** +1 561 688 8700  
**Middle East** +43 1 333 50 34 0  
**Netherlands** +31 76 579 55 55  
**New Zealand** +64 9 980 6700  
**Norway** +46 8 556 468 00  
**Russia/CIS** +43 1 333 50 34 0

**Singapore** +65 6289 1190  
**Spain** +34 914 845 965  
**Sweden** +46 8 556 468 00  
**Switzerland** +41 61 716 77 00  
**UK** +44 1442 233555  
**USA** +1 800 532 4752

**Thermo**  
 S C I E N T I F I C

A Thermo Fisher Scientific Brand



# Identification and Quantitation of Microcystins by Targeted Full-Scan LC-MS/MS

Terry Zhang, Reiko Kiyonami, Leo Wang and Guifeng Jiang  
Thermo Fisher Scientific, San Jose, CA, USA

## Key Words

Velos Pro, UltiMate, Water Analysis, Cyanobacteria, Microcystin

## Goal

Develop a simple and sensitive LC-MS method for definitive identification and quantitation of microcystins in water.

## Introduction

Cyanobacteria, commonly referred to as blue-green algae, are photosynthetic prokaryotes that occur naturally in surface waters. They contribute significantly to primary production and nutrient cycling. Eutrophic, warm and low turbulent conditions in freshwater bodies typically promote the dominance of cyanobacteria within phytoplankton communities. Excessive proliferation of cyanobacteria leads to blooms that disrupt ecosystems, adversely affect the taste and odor of water, and increase water treatment costs. Blooms of toxic cyanobacteria species in surface drinking water sources and recreational waters threaten human health. Gastrointestinal illness, skin irritation, and death following renal dialysis have been attributed to acute cyanotoxin exposure. Chronic exposure can cause liver damage and may be associated with primary liver cancer.<sup>1</sup> The incidence and severity of cyanobacterial blooms are increasing globally, underscoring the importance of cyanotoxin monitoring.

The most commonly encountered cyanotoxins are the microcystins, a group of hepatotoxic cyclic heptapeptides produced by various genera of cyanobacteria, including *Microcystis*, *Planktothrix*, and *Anabaena*. The chemical structure of a microcystin, depicted in Figure 1, is characterized by the presence of the amino acid 3-amino-9-methoxy-2,6,8-trimethyl-10-phenyl-deca-4,6-dienoic acid (Adda), which modulates the biological activity of these toxins, and N-methyldehydroalanine (Mdha). Microcystin nomenclature is based on the L-amino acids present at two positions (X and Y in Figure 1) in the molecule. Over 80 structural variants are known, differentiated by the two variable L-amino acids as well as by chain modifications. The inhibition of serine/threonine protein phosphatases type 1 and 2A is considered the major mechanism of microcystin toxicity. Microcystin-LR, one of the most prevalent and potent microcystins, is designated as possibly carcinogenic to humans by the International Agency for Research on Cancer (IARC).<sup>2</sup> The potential risk of chronic exposure to microcystins in drinking water supplies prompted the World Health Organization (WHO) to issue a provisional guideline of 1 µg/L as the maximum concentration of total microcystin-LR (free plus cell-bound) in drinking water.<sup>3</sup> Many national and regional governments have since adopted this guideline value directly or have established slightly modified variants.

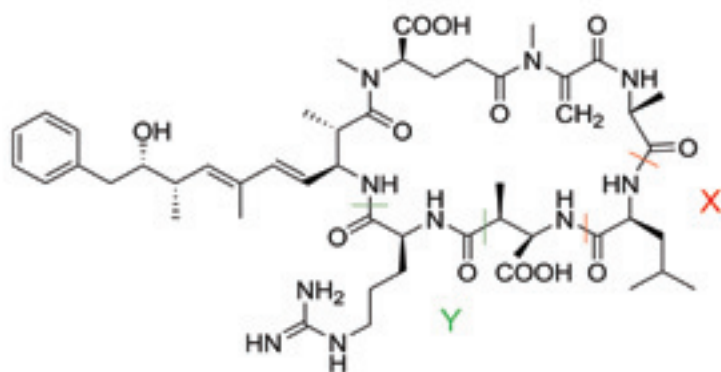

Figure 1. The chemical structure of MC-LR contains leucine (L) and arginine (R) at positions X and Y, respectively. Microcystin nomenclature is based on the L-amino acids present at these two positions.

A toxic cyanobacterial bloom usually consists of multiple microcystin congeners in varying concentrations. Several techniques for the analysis of microcystins have been developed. Mouse bioassays, protein phosphatase inhibition assays, and enzyme-linked immunosorbent assays (ELISA) are effective for rapid screening but lack specificity. Reversed-phase high-performance liquid chromatography (HPLC) with ultraviolet (UV) detection is the most common approach used for the separation, detection and quantitation of microcystins. An ISO method for microcystin analysis by HPLC-UV has been validated for MC-RR, MC-YR and MC-LR.<sup>4</sup> However, UV detection is susceptible to interferences from water matrices and requires sample cleanup and concentration to achieve desirable detection limits. Furthermore, UV-based methods do not provide unequivocal identification of known microcystins nor enable identification of unexpected variants. Liquid chromatography in combination with multi-stage mass spectrometry (LC-MS<sup>n</sup>) enables structural characterization and unambiguous identification of trace levels of microcystins. LC-MS/MS in multiple reaction monitoring (MRM) acquisition mode allows highly selective and sensitive quantitation and confirmation of target microcystins, but this approach requires extensive compound-dependent parameter optimization and cannot be used to detect unexpected toxins. Full-scan MS/MS approaches obviate the need for compound optimization and enable determination of all microcystins present in a sample.

The Thermo Scientific Velos Pro dual-pressure linear ion trap mass spectrometer delivers sensitivity and speed for qualitative and quantitative applications. High-quality full-scan MS<sup>n</sup> spectra enable confident structural elucidation and identification. Rapid scanning and fast cycle times generate more scans across chromatographic peaks for robust quantitation and allow the acquisition of more MS<sup>n</sup> spectra in shorter chromatographic runs. A wide dynamic range of up to six orders of magnitude facilitates identification and quantitation of low-abundance compounds in complex matrices. Complementary fragmentation techniques may be performed in parallel to enable more MS<sup>n</sup> information to be obtained from a single sample. In this application note, we describe a simple and sensitive targeted full-scan LC-MS/MS method for the identification and quantitation of the microcystins MC-RR, MC-YR, and MC-LR using the Velos Pro™ ion trap mass spectrometer coupled to a Thermo Scientific Dionex UltiMate 3000 x2 Dual RSLC system.

## Experimental

### Sample Preparation

MC-RR, MC-YR and MC-LR standards were purchased from Sigma-Aldrich®. A stock solution of a mixture of these three microcystins was prepared at a concentration of 5 µg/mL. Calibration solutions, with concentrations of 0.025 µg/L to 50 µg/L, were prepared by serial dilution of the stock solution.

### LC-MS/MS Analysis

A 50 µL sample was injected on a Thermo Scientific Acclaim 120 guard cartridge with 150 L/min, washed for two minutes to waste and then eluted onto a Thermo Scientific PepMap100 analytical column for separation. LC-MS/MS analysis was performed on an UltiMate™ 3000 x2 Dual RSLC system coupled to an Velos Pro mass spectrometer.

#### LC Parameters

Guard cartridge:	Acclaim™ 120 C18 (10 x 3.0 mm i.d., 5.0 µm particle size, 120 Å pore size)
Analytical column:	Acclaim PepMap100 C18 (150 x 1.0 mm i.d., 3.0 µm particle size, 100 Å pore size)
Mobile Phase A:	Water containing 0.1% formic acid
Mobile Phase B:	Acetonitrile containing 0.1% formic acid
Column temperature:	40 °C
Sample injection volume:	50 µL
Flow rate:	150 µL/min
Gradient:	Table 1

Table 1: LC Gradient

Time	% A	% B
0.1	98	2
1.5	98	2
2.0	80	20
3.0	60	40
7.4	40	60
7.5	2	98
7.9	2	98

#### MS Parameters

Ionization mode:	Positive electrospray ionization (ESI)
Collision energy:	35%
Isolation window:	2
Targeted full-scan MS/MS:	MC-RR [M+2H] <sup>2+</sup> at <i>m/z</i> 520 [ <i>m/z</i> 150-1100] MC-YR [M+H] <sup>+</sup> at <i>m/z</i> 1045 [ <i>m/z</i> 285-1100] MC-LR [M+H] <sup>+</sup> at <i>m/z</i> 995 [ <i>m/z</i> 285-1100]

**Structural Identification and Confirmation**

Figure 2 shows extracted ion chromatograms and MS/MS spectra obtained from full-scan LC-MS/MS analysis of a mixture containing MC-RR, MC-YR and MC-LR at concentrations of 0.5 µg/L. MC-RR, MC-YR and MC-LR eluted at 5.62, 6.85, and 6.93 minutes, respectively. The MS/MS spectrum of MC-RR was generated by collision-induced dissociation (CID) of the  $[M+2H]^{2+}$  ion and is characterized by major fragment ions at  $m/z$  505, 452 and 887, which correspond to  $[M+2H-CO]^{2+}$ ,  $[M+2H-C_9H_{10}O]^{2+}$  and  $[M+H-C_9H_{10}O-NH_3]^+$ , respectively ( $C_9H_{10}O$  is a fragment of the Adda residue). The closely eluting compounds MC-YR and MC-LR are easily distinguished by their

MS/MS spectra. The MS/MS spectrum of MC-YR, generated by CID of the  $[M+H]^+$  ion, contains major fragment ions at  $m/z$  1017, 599, and 916, which correspond to  $[M+H-CO]^+$ ,  $[Arg+Adda+Glu+H]^+$ , and  $[Arg+Adda+Glu+Mdha+Ala+Tyr+H]^+$ , respectively. The CID MS/MS spectrum of the  $[M+H]^+$  ion of MC-LR is characterized by major fragment ions at  $m/z$  967, corresponding to  $[M+H-CO]^+$ ;  $m/z$  599, corresponding to  $[Arg+Adda+(Glu\ or\ MeAsp)+H]^+$ ;  $m/z$  866, corresponding to  $[Ala+Adda+Arg+(Glu\ or\ MeAsp)+Leu+Mdha+H]^+$ ; and  $m/z$  553, corresponding to  $[Ala+Arg+(Glu\ or\ MeAsp)+Leu+Mdha+H]^+$ .

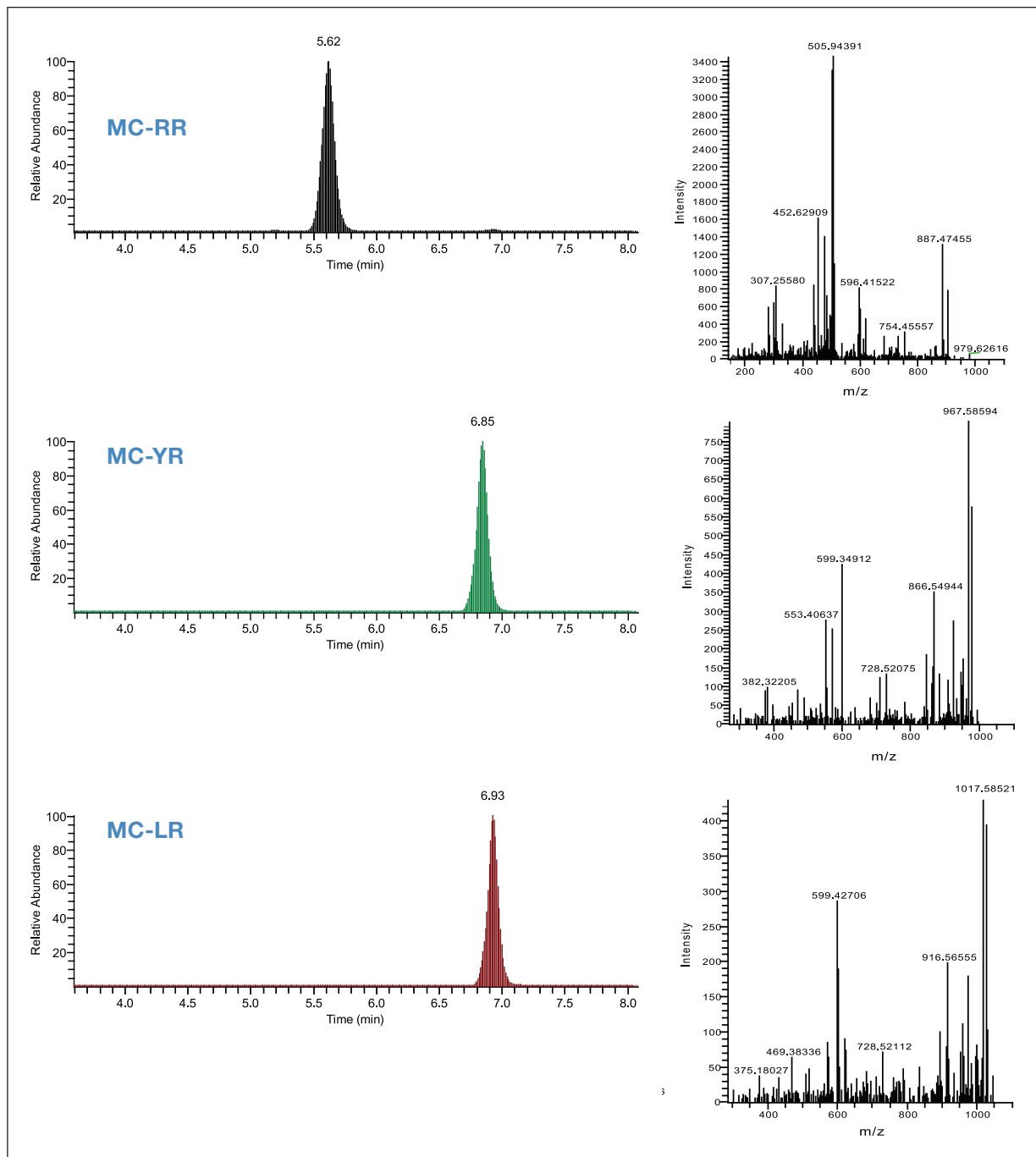

Figure 2. Extracted ion chromatograms and MS/MS spectra for MC-RR, MC-YR and MC-LR at concentrations of 0.5 µg/L



### Quantitative Analysis

The high scan speeds and fast analytical cycle time of the Velos Pro mass spectrometer enabled higher numbers of analytical scans across chromatographic peaks for optimal quantitative reliability (Figure 3). Excellent linearity in detector response was observed over the range of 0.05-50 µg/L for all three microcystins. Calibration curves for MC-RR, MC-YR and MC-LR are shown in Figure 4, with coefficients of determination of 0.9986, 0.9994, and 0.9994, respectively. The lowest detectable amount (LOD) of 0.025 µg/L and quantifiable amount (LOQ) of 0.05 µg/L were achieved for each microcystin. Both QC samples, at levels of 0.5 and 5 µg/L, achieved quantitation accuracy better than 94% for all three microcystins. Signal-to-noise ratios of >25 with automatic ICIS algorithm integration in Thermo Scientific Xcalibur software were obtained for MC-LR at the LOQ (Figure 5), demonstrating that this LC-MS/MS method can be used to determine MC-LR at concentrations well below the WHO's recommended guideline level of 1 µg/L.

Method reproducibility was investigated by analyzing five replicate injections of each analyte. Peak area RSDs for MC-LR and MC-YR were less than 7% and 11%, respectively, over the entire linear dynamic range (Table 2). For MC-RR, peak area RSDs over the range 0.10-50 µg/L were under 6%; at the LOQ, the peak area RSD was 16% (Table 2). Retention time precisions were 0.3% RSD or less over the entire dynamic range (Figure 6) for all three microcystins. Tap water, filtered water and surface pond water were analyzed using this method. No microcystins were in any of the three water sources.

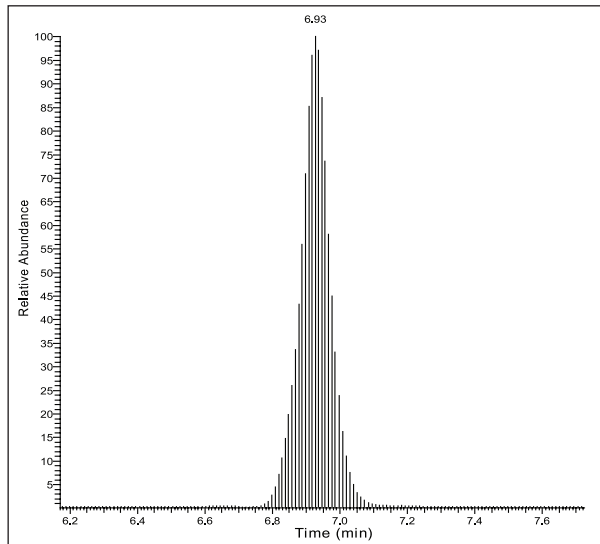

Figure 3. High scan speeds and fast cycle times enable more than 20 data points to be acquired across the MC-LR chromatographic peak.

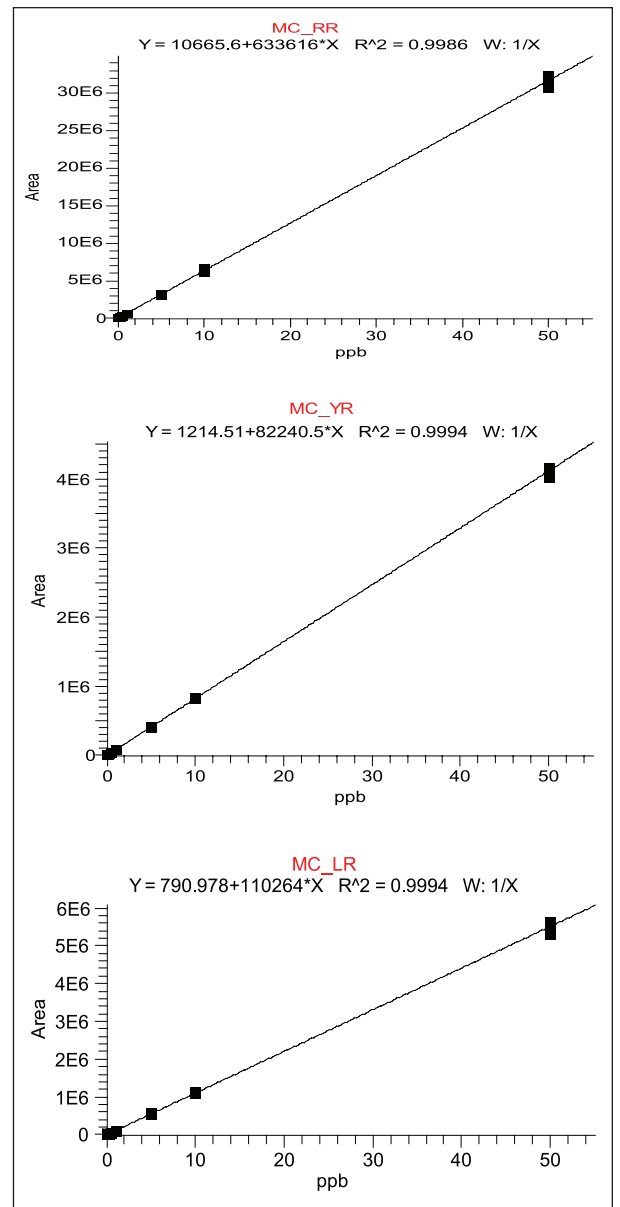

Figure 4. Calibration curves for quantitation of MC-RR, MC-YR and MC-LR

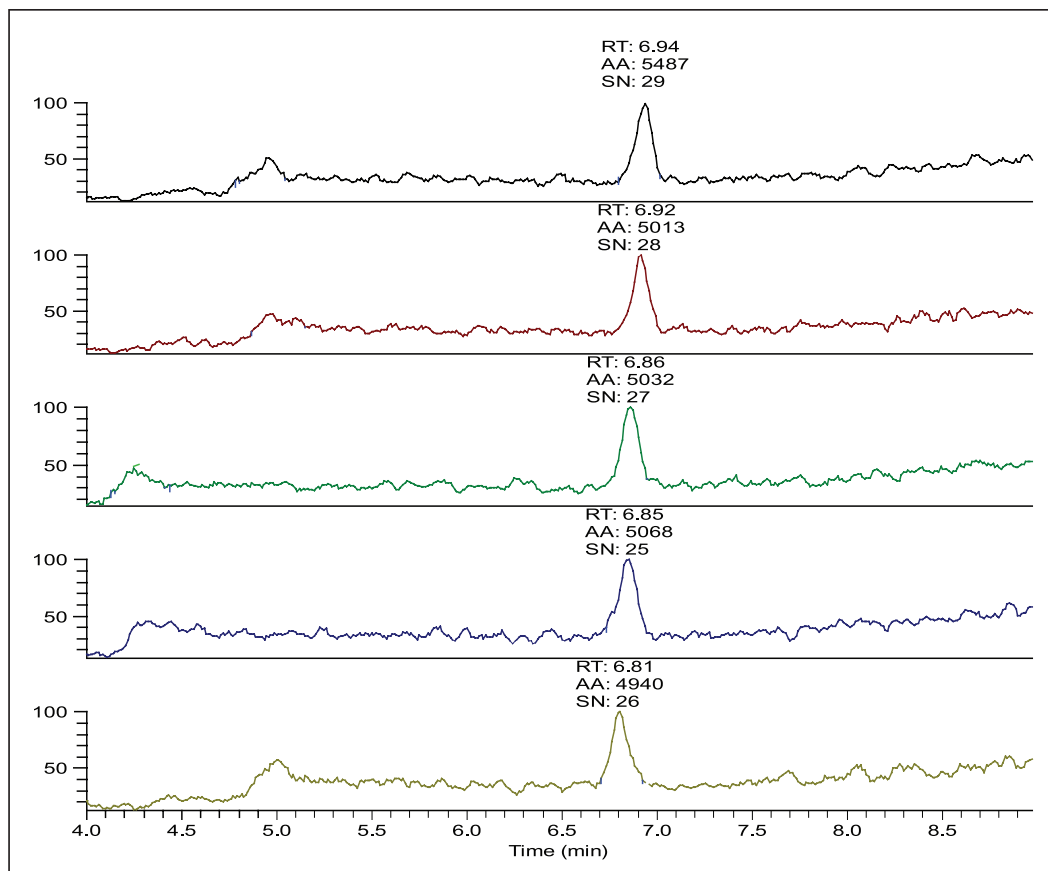

Figure 5. For MC-LR at the LOQ (0.05  $\mu\text{g/L}$ ),  $S/N > 25$  and peak area RSD = 6.91%

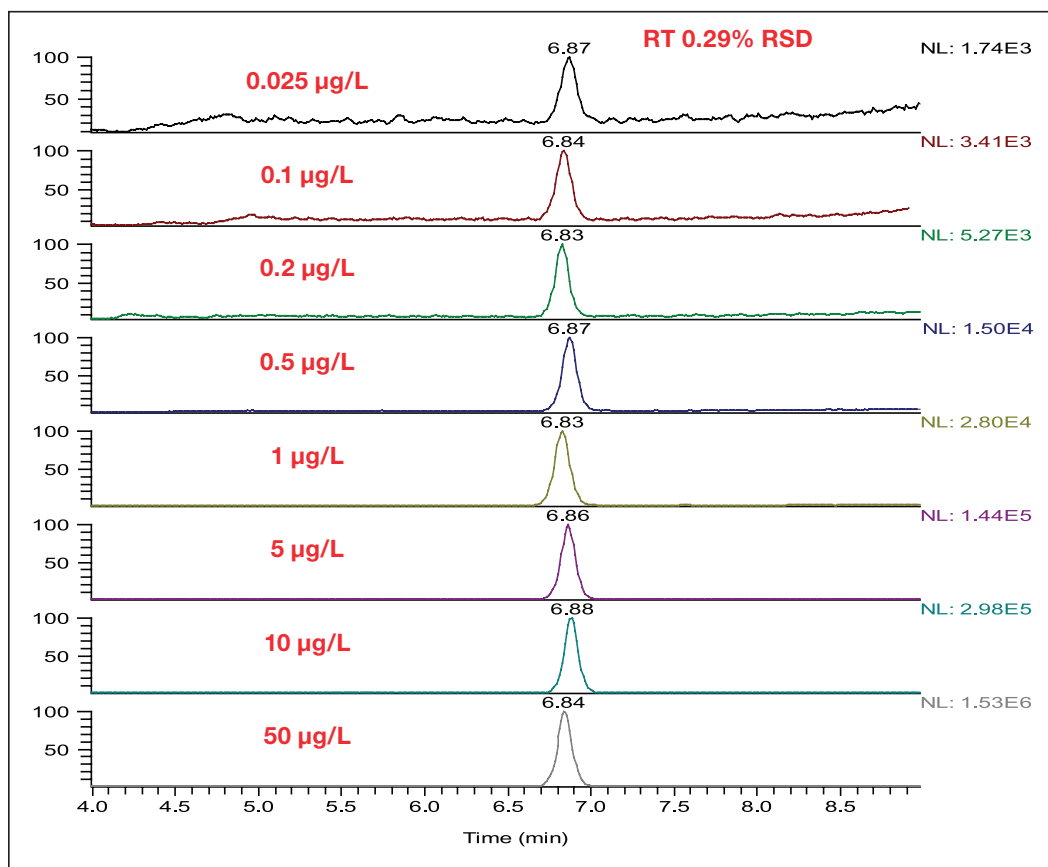

Figure 6. High retention-time precision ( $< 0.3\%$  RSD) over a wide linear dynamic range

Table 2. Peak area precision (from five replicate injections) for LC-MS/MS assay of MC-RR, MC-YR and MC-LR

Levels µg/L	MC-RR	MC-YR	MC-LR
0.05	16.01	10.5	6.91
0.10	2.82	5.88	3.97
0.20	3.54	5.25	4.89
0.50	4.86	8.54	3.03
1.00	5.84	1.76	4.25
5.00	2.28	2.13	2.47
10.00	4.54	1.30	1.31
50.00	2.40	1.76	2.66

## Conclusion

A simple, sensitive and robust LC-MS method for quantitative determination of microcystins was developed. Targeted full-scan MS/MS analysis using the LTQ Velos Pro linear ion trap mass spectrometer provided excellent selectivity and sensitivity for the identification and quantitation of MC-RR, MC-YR and MC-LR across a wide linear dynamic range. The LOD and LOQ were 0.025 µg/L and 0.05 µg/L, respectively. The LOQ was significantly lower than the provisional guideline value established by the WHO for MC-LR concentrations in drinking water. Assays performed in full-scan MS/MS mode enable compound confirmation and quantitation without the need for compound-dependent parameter optimization. The method was used to analyze tap, filtered and surface pond water. No microcystins were detected from these three water sources.

## References

1. *Toxic cyanobacteria in water: A guide to their public health consequences, monitoring and management*; Chorus I, Bartram J, eds. Published by E & FN Spon, London, on behalf of the World Health Organization, Geneva. 1999
2. Ingested Nitrate and Nitrite and Cyanobacterial Peptide Toxins. *IARC Monogr Eval Carcinog Risks Hum*, 2010, 94:1–477.
3. *WHO Guidelines for Drinking-water Quality*, 3rd Ed., Vol. 1, Recommendations; WHO, Geneva. 2004
4. *ISO Water Quality: Determination of microcystins - method using solid phase extraction (SPE) and high performance liquid chromatography (HPLC) with ultraviolet (UV) detection*. ISO, Geneva, Switzerland (ISO 20179:2005).

[www.thermofisher.com](http://www.thermofisher.com)

©2016 Thermo Fisher Scientific Inc. All rights reserved. Sigma-Aldrich is a registered trademark of Sigma-Aldrich Biotechnology L.P. All other trademarks are the property of Thermo Fisher Scientific Inc. and its subsidiaries. This information is presented as an example of the capabilities of Thermo Fisher Scientific Inc. products. It is not intended to encourage use of these products in any manners that might infringe the intellectual property rights of others. Specifications, terms and pricing are subject to change. Not all products are available in all countries. Please consult your local sales representative for details.

**Africa-Other** +27 11 570 1840  
**Australia** +61 3 9757 4300  
**Austria** +43 1 333 50 34 0  
**Belgium** +32 53 73 42 41  
**Canada** +1 800 530 8447  
**China** +86 10 8419 3588  
**Denmark** +45 70 23 62 60

**Europe-Other** +43 1 333 50 34 0  
**Finland/Norway/Sweden**  
+46 8 556 468 00  
**France** +33 1 60 92 48 00  
**Germany** +49 6103 408 1014  
**India** +91 22 6742 9434  
**Italy** +39 02 950 591

**Japan** +81 45 453 9100  
**Latin America** +1 561 688 8700  
**Middle East** +43 1 333 50 34 0  
**Netherlands** +31 76 579 55 55  
**New Zealand** +64 9 980 6700  
**Russia/CIS** +43 1 333 50 34 0  
**South Africa** +27 11 570 1840

**Spain** +34 914 845 965  
**Switzerland** +41 61 716 77 00  
**UK** +44 1442 233555  
**USA** +1 800 532 4752

**Thermo**  
**SCIENTIFIC**

Part of Thermo Fisher Scientific

# Determination of Lipophilic Marine Biotoxins in Molluscs by LC-MS/MS using Offline Extraction

Francesca G. Bellagambi, Department of Chemistry and Industrial Chemistry, University of Pisa, Italy

Cláudia P. B. Martins, Thermo Fisher Scientific, Barcelona, Spain

Michal Godula, Thermo Fisher Scientific, Prague, Czech Republic

Alessio Ceccarini, Department of Chemistry and Industrial Chemistry, University of Pisa, Italy

## Key Words

TSQ Quantum Ultra, Food Safety, Marine Biotoxins

## Introduction

In recent years many countries have had to deal with the consequences of toxic microalgal blooms in both marine and fresh water, such as the deaths of wild animals and domestic livestock.

Several cases of poisoning in humans have been associated with the direct consumption of shellfish, fish, or water contaminated by algal toxins. People may also come into contact with toxins during recreational activities along sea coasts affected by episodes of algal blooms. Depending on the type of toxin involved, there are forms of mild and usually self-limiting symptoms, characterized by gastrointestinal disorders or allergic-like episodes. Much more severe symptoms of the neurological type can lead to death.

The foods most frequently involved in episodes of human poisoning are represented by bivalve molluscs. These shellfish can accumulate and concentrate any biotoxins present in the plankton they ingest through filtering large quantities of water for trophical reasons. It is not possible to evaluate shellfish edibility by an organoleptic examination alone. While human ingestion of contaminated food with biotoxins can lead to the onset of different clinical symptoms, in shellfish it usually has only marginal effects. An important risk factor lies in the thermostability of such molecules which are not completely inactivated by common physical treatments for fish products (cooking, smoking, salting, freezing, housing), but remain virtually unchanged in the finished product.



There are a series of regulations issued by the European Union (EU) that relate to marine biotoxins. One is Regulation (EC) No 853/2004 which concerns the control of lipophilic toxins, establishing maximum levels for lipophilic toxins in bivalve molluscs destined for human consumption:<sup>1</sup>

- For okadaic acid, dinophysistoxins, and pectenotoxins together – 160 micrograms of okadaic acid equivalents per kilogram
- For yessotoxin – 1 milligram of yessotoxin equivalent per kilogram
- For azaspiracids – 160 micrograms of azaspiracid equivalents per kilogram

In the past, aside from bioassays on mice, most analytical techniques developed for the determination of marine biotoxins in bivalve molluscs have been based on offline methodologies. These include methods involving solid phase extraction (SPE) or liquid-liquid extraction (LLE) followed by high pressure liquid chromatography (HPLC) with fluorimetric or UV-diode array detection, as well as detection by liquid chromatography coupled with mass spectrometry (LC-MS).

The EU Commission Regulation (EC) No 15/2011, amending Regulation (EC) No 2074/2005 about the testing methods for detecting marine biotoxins in bivalve molluscs, describes an LC-MS/MS procedure as the reference method for the quantification of lipophilic marine biotoxins – namely okadaic acid, pectenotoxin 2, azaspiracid 1, and yessotoxin.<sup>2,3</sup> Moreover, dinophysistoxin 1 (DTX-1) and dinophysistoxin 2 (DTX-2) can be quantified by the calibration curve of okadaic acid, pectenotoxin 1 by calibration of pectenotoxin 2, azaspiracid 2 and 3 by calibration of azaspiracid 1 and 45-OH-, and 45-homo-OH-yessotoxin by the calibration of yessotoxin.

In accordance with current European regulations, we propose a quick, selective, sensitive, and accurate analytical method for the determination of lipophilic marine biotoxins in bivalve molluscs using an LC-MS/MS method.

## Goal

Our goal is to validate analytical procedures proposed in “EU-Harmonised Standard Operating Procedure for determination of Lipophilic marine biotoxins in molluscs by LC-MS/MS – Version 3” by LC-MS/MS using offline extraction.<sup>4</sup>

## Experimental

### Sample Preparation

About 1 kg of bivalve molluscs (*Mytilus Galloprovincialis*) were cleaned with water and put in a solution of NaCl (3.5 g/L). After opening, the molluscs were washed with fresh water, their flesh was removed and placed on a stainless steel net, and they were washed again with deionized water. The whole collected raw tissue, not less than 150 g, was chopped and blended by a mixer.

### Extraction procedure

9 mL of 100% methanol (gradient quality) were added to 2.00 ± 0.05 g of blended tissue, put into a centrifuge tube, and mixed by vortex for 3 minutes at maximum speed. After centrifugation at 4000 rpm for 10 minutes, the supernatant solution was transferred into a vial.

A second aliquot of 9 mL of 100% methanol was further added to the residual tissue pellet and homogenized for 1 minute by Ultra-turrax® (IKA®, USA) at 12,000 rpm and the mixture was centrifuged at 4000 rpm for 10 minutes. Then the supernatant solution was transferred and

combined with the first extract and made up to 20 mL with 100% methanol. When not immediately analyzed, the solution was stored at -20 °C.

Spikes of toxin standard solutions can be added to the blended tissue before the extraction procedure.

### Purification Procedure

The organic extract was purified by being passed through a C18 SPE cartridge preliminarily conditioned with 1 mL of 100% methanol. A 0.45 µm syringe filter was placed at the end of the cartridge to improve purification.

### LC Conditions for the Thermo Scientific Hypersil GOLD Column

System	Thermo Scientific Accela UHPLC
Solvent A	100% water with 2 mM ammonium formate and 50 mM formic acid
Solvent B	95% acetonitrile + 5% water with 2 mM ammonium formate and 50 mM formic acid
Flow Rate	200 µL/min
Gradient	The mixture started at 30% solvent B (8.0 min) followed by a linear gradient up to 90% solvent B in 3.0 min. It went up to 30% of solvent B in 0.5 min. This composition was maintained for 5.5 min.
Analytical Column	Hypersil GOLD™; 50 × 2.1 mm, particle size 1.9 µm, part number 25002-052130

### H-ESI II Source Conditions

Ion Source Polarity	Positive Ion Mode	Negative Ion Mode
Spray Voltage	3000 V	2700 V
Capillary Temperature	270 °C	270 °C
Vaporizer Temperature	240 °C	240 °C
Sheath Gas Pressure (N <sub>2</sub> )	15 units	15 units
Auxiliary Gas Pressure (N <sub>2</sub> )	5 units	5 units

### MS/MS Setup

MS analysis was carried out on a Thermo Scientific TSQ Quantum Ultra triple quadrupole mass spectrometer equipped with a heated electrospray ionization probe (H-ESI II).

Collision Gas (Ar)	1.5 mTorr
Q1/Q3 Peak Resolution	0.7 u (unit mass resolution)
Scan Time	0.100 s
Scan Width	0.500 m/z
Data Acquisition Mode	SRM

Analyte	ESI Mode	Parent Mass	Product Mass	Collision Energy	Tube Lens
AZA-1	ESI+	842.3	806.1	51	207
			824.2	42	207
AZA-2	ESI+	856.3	838.1	42	214
			820.2	49	214
AZA-3	ESI+	828.3	792.2	48	192
			810.0	40	192
PTX-2	ESI+	876.3	841.3	35	205
			823.0	40	205
			805.3	41	205
DTX-1	ESI-	817.0	255.0	69	197
			113.1	67	197
DTX-2	ESI-	803.15	255.3	61	207
			113.1	50	207
YTX	ESI-	1141.5	1061.7	50	240
		570.2	467.3	40	240
OA	ESI-	803.3	254.9	68	216
			113.1	50	216

Table 1: Selected ion transitions ( $m/z$ ) of the studied compounds and optimized collision energy and tube lens value for the TSQ Quantum Ultra triple quadrupole mass spectrometer

The optimization of selective reaction monitoring (SRM) parameters was performed by direct infusion of standards. Collision-induced dissociation (CID) data were recorded for each analyte including optimum collision energies for the selected ion transitions.

Table 1 summarizes all the mass transitions found for each analyte and its relative collision energy (CE) and tube lens values.

## Results and Discussion

To ensure thorough validation of the method, neat standard solutions, standard addition on purified extracts, and spiked blank tissue extracts were prepared and compared.

Table 2 lists the correlation coefficients ( $r^2$ ) indicating the linearity of the calibration curves for the three types of samples analyzed; five concentrations of the sample solution are considered (2, 5, 10, 20, and 50  $\mu\text{g}/\text{kg}$  or similar).

To assess the inter-day repeatability of the method, ten replicates of spiked samples were analyzed between days. Solutions were prepared containing all the toxins in the five different concentrations used to perform the calibration curves (2, 5, 10, 20, and 50  $\mu\text{g}/\text{kg}$  or similar).

The repeatability of the method expressed as the coefficient of variation percentage (CV %) has been rated less than 20% as shown in Table 3.

Analyte	Neat Solution	Spiked Purified Extract	Spiked Extract
AZA-1	0.9932	0.9965	0.9970
AZA-2	0.9973	0.9964	0.9901
AZA-3	0.9972	0.9958	0.9993
DTX-1	0.9964	0.9995	0.9953
DTX-2	0.9973	0.9966	0.9965
YTX	0.9999	0.9923	0.9988
PTX-2	1.0000	0.9977	0.9927
OA	0.9955	0.9924	0.9927

Table 2: Correlation Coefficient ( $r^2$ ) of the calibration curves for the three types of samples analyzed in the concentration range of 2–50  $\mu\text{g}/\text{kg}$

Analyte	Standard Deviation	Repeatability	CV%
AZA-1	0.25	0.79	20
AZA-2	0.29	0.90	18
AZA-3	0.43	1.37	17
DTX-1	0.18	0.55	2
DTX-2	0.22	0.68	9
YTX	0.12	0.40	12
PTX-2	0.39	1.36	20
OA	0.16	0.48	4

Table 3: Values of CV% obtained for the repeatability of the lower concentrated curve point (2  $\mu\text{g}/\text{kg}$ )



The calculations, of limit of detection (LOD) and limit of quantification (LOQ) were made in accordance with the *UNICHIM Manual N. 179/0* where the calculation of the limit of detection is made through the calibration curve of the instrument used for analysis.<sup>5</sup>

To estimate the LOD and LOQ of the method (Table 4), ten samples were prepared by adding standard solution to 500 mg of homogenized mussel flesh and repeating the extraction procedure according to the method in “*EU-Harmonised Standard Operating Procedure for determination of Lipophilic marine biotoxins in molluscs by LC-MS/MS – Version 3*”. LOD and LOQ are expressed in µg/Kg. Recoveries are shown in Table 5.

Hypersil GOLD			
Analyte	LOD (µg/Kg)	LOQ (µg/Kg)	Outliers (Huber Test)
AZA-1	0.56 ± 0.18	1.11	NO
AZA-2	0.93 ± 0.31	1.86	NO
AZA-3	1.28 ± 0.43	2.57	NO
DTX-1	5.66 ± 1.02	10.45	NO
DTX-2	0.71 ± 0.23	1.42	NO
YTX	1.67 ± 0.56	3.33	NO
PTX-2	1.40 ± 0.46	2.79	NO
OA	3.95 ± 1.32	7.91	NO

Table 4: LOD and LOQ of the method

Analyte	Spiked Purified Extract	Spiked Extract
AZA-1	96 ± 11	97 ± 11
AZA-2	101 ± 9	94 ± 14
AZA-3	104 ± 10	99 ± 6
DTX-1	101 ± 6	101 ± 7
DTX-2	101 ± 6	108 ± 42
YTX	99 ± 15	102 ± 17
PTX-2	103 ± 13	102 ± 20
OA	95 ± 7	93 ± 18

Table 5: Recovery values, where  
 $R\% = \left\{ \frac{[(\mu\text{g}/\text{Kg})_{\text{CALCULATED}} / (\mu\text{g}/\text{Kg})_{\text{THEORETICAL}}] * 100 \right\}$

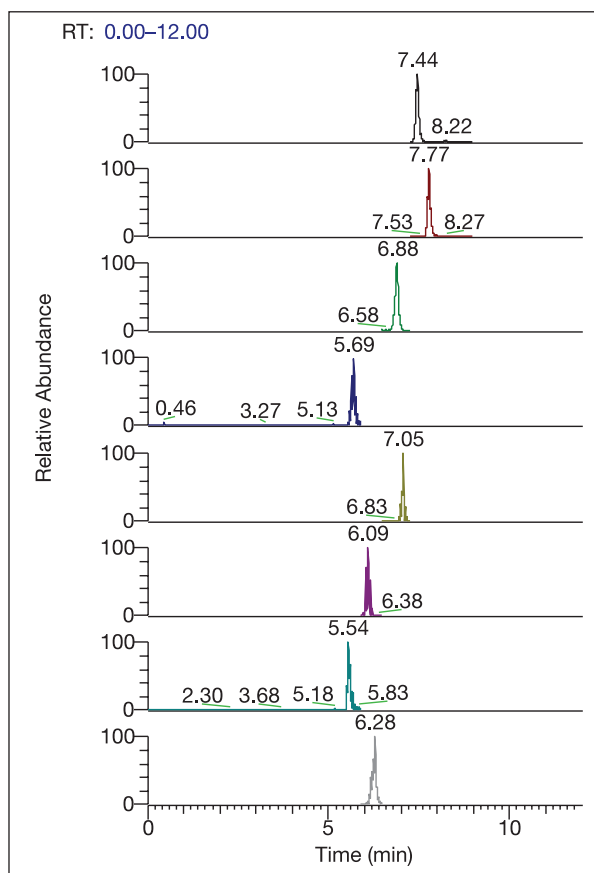

Figure 1: Chromatogram of sample containing 40 ppb of toxins (Retention Time: 7.44 min – AZA-1; 7.77 min – AZA-2; 6.88 min – AZA-3; 5.69 min – OA; 7.05 min – DTX-1; 6.06 min – DTX-2; 5.54 min – YTX; 6.28 min – PTX-2)

## Conclusion

This method proved to be selective, sensitive, accurate, and reproducible. It can be successfully applied for the quantitative determination of several classes of lipophilic marine biotoxins in bivalve mollusc samples.

## References

1. Regulation (EC) No 853/2004 of the European Parliament and of the Council of 29 April 2004. *Official Journal of the European Communities* L139, 55-255.
2. Commission Regulation (EU) No 15/2011 of 10 January 2011. *Official Journal of the European Union*. L6, 3-9.
3. Commission Regulation (EC) No 2074/2005 of 5 December 2005. *Official Journal of the European Communities*, L388, 27-59.
4. European Union Reference Laboratory for Marine Biotoxins (EU-RL-MB), Agencia Española de Seguridad Alimentaria y Nutrición (AESAN). *EU-Harmonised Standard Operating Procedure for determination of Lipophilic marine biotoxins in molluscs by LC-MS/MS – Version 3*. 2011.
5. UNICHIM, Manual N. 179/0. *Linee guida per la convalida di metodi analitici nei laboratori chimici - criteri generali*. Milano. 1999.

[www.thermoscientific.com](http://www.thermoscientific.com)

©2016 Thermo Fisher Scientific Inc. All rights reserved. ULTRA-TURRAX and IKA are registered trademarks of IKA-Werke GmbH & Co. All other trademarks are the property of Thermo Fisher Scientific Inc. and its subsidiaries. This information is presented as an example of the capabilities of Thermo Fisher Scientific Inc. products. It is not intended to encourage use of these products in any manner that might infringe the intellectual property rights of others. Specifications, terms and pricing are subject to change. Not all products are available in all countries. Please consult your local sales representative for details.

**Africa-Other** +27 11 570 1840  
**Australia** +61 3 9757 4300  
**Austria** +43 1 333 50 34 0  
**Belgium** +32 53 73 42 41  
**Canada** +1 800 530 8447  
**China** +86 10 8419 3588  
**Denmark** +45 70 23 62 60  
**Europe-Other** +43 1 333 50 34 0  
**Finland/Norway/Sweden** +46 8 556 468 00  
**France** +33 1 60 92 48 00  
**Germany** +49 6103 408 1014  
**India** +91 22 6742 9434  
**Italy** +39 02 950 591

**Japan** +81 45 453 9100  
**Latin America** +1 561 688 8700  
**Middle East** +43 1 333 50 34 0  
**Netherlands** +31 76 579 55 55  
**New Zealand** +64 9 980 6700  
**Russia/CIS** +43 1 333 50 34 0  
**South Africa** +27 11 570 1840

**Spain** +34 914 845 965  
**Switzerland** +41 61 716 77 00  
**UK** +44 1442 233555  
**USA** +1 800 532 4752

AN63552\_E 08/16M

**Thermo**  
 SCIENTIFIC  
 Part of Thermo Fisher Scientific







# Surface, Drinking and Waste Water Analysis

Contaminants of Emerging Concern and  
Other Water Analysis

# Targeted and Nontargeted MS Analysis of Contaminants in Storm Water Retention Ponds

Gordon Getzinger<sup>1</sup>, P. Lee Ferguson<sup>1</sup>, Jonathan Beck<sup>2</sup>, Charles Yang<sup>2</sup>, Frans Schoutsen<sup>3</sup>

<sup>1</sup>Duke University, Durham, NC, USA

<sup>2</sup>Thermo Fisher Scientific, San Jose, CA, USA

<sup>3</sup>Thermo Fisher Scientific, Breda, The Netherlands

## Key Words

Environmental analysis, water analysis, wastewater, micropollutants, EQUAN MAX Plus, TSQ Quantiva, LTQ Orbitrap Velos

## Goal

To demonstrate a data-driven environmental monitoring approach for examining the occurrence and distribution of wastewater-derived contaminants and turf-grass management organic compounds in storm water retention ponds.

## Introduction

Comprehensive assessment of the aquatic fate and effects of organic micropollutants is greatly hindered by the need to develop compound-specific methodologies prior to sampling and analysis. A data-driven workflow, coupling high-resolution, accurate-mass (HRAM) mass spectrometry and highly sensitive online solid phase extraction (SPE) analysis, ensures complete characterization of organic pollutants in aquatic environments. In this work, water samples collected from a coastal golf course community were screened for the presence of trace organic contaminants by a non-targeted HPLC–HRAM mass spectrometry workflow. The occurrence of identified and confirmed contaminants was then quantitatively assessed by a high-throughput online SPE LC-MS/MS method.

## Experimental

### Sample Collection

Surface water, groundwater, and wastewater effluent samples were collected from Kiawah Island, SC (Figure 1), a coastal golf course community where turf-grass management chemicals are extensively applied and reclaimed wastewater is used for irrigation. Golf course and storm water runoff are collected in ponds, which are interconnected through a series of culverts and communicate with the adjacent tidal estuary through managed outfalls.

Initial sampling for non-targeted screening consisted of 0.5 L grab samples collected and field extracted by SPE over two weeks in May 2010. Similarly, 10 mL grab samples were collected in May 2011 for quantitative analysis.

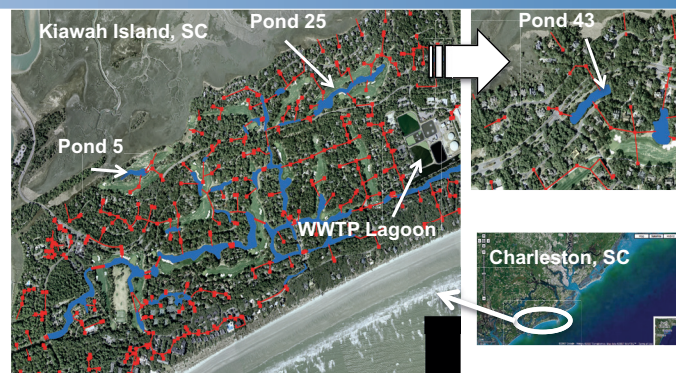

Figure 1. Aerial view of Kiawah Island, SC. Water collection ponds, shown in blue, are connected as indicated by the red lines.

Sample sites were chosen to represent various routes of micropollutant loading into the aquatic environment and potential routes of chemical exposure as detailed in Table 1. Golf course runoff consists of both turf-grass-management chemicals applied to the course and wastewater-derived contaminants introduced through irrigation.

Table 1. Sample sites and descriptions of potential sources of micropollutants to those sites

Sample Site	Inputs
Pond 5	Golf course runoff
Pond 25	Golf course runoff
Pond 43	Residential storm water
Wastewater treatment plant lagoon (WWTP)	Treated municipal wastewater
Wastewater composite (WW Comp.)	24 hr composite effluent
Well 1	Infiltration from pond 25
Well 7	Infiltration from pond 5

### Broad-Spectrum HPLC-HRAM MS Screening

To begin analysis, broad-spectrum MS screening was performed on a Thermo Scientific™ LTQ Orbitrap Velos™ hybrid ion trap-Orbitrap MS using heated electrospray ionization (HESI). The instrument was operated in positive full-scan ( $m/z$  100-1000) mode at a resolving power of 60,000 (FWHM) at  $m/z$  400. Data-Dependent Top 3 HRAM MS/MS experiments were performed with dynamic exclusion and peak apex detection.

### Non-Targeted Compound Identification

After broad-spectrum data acquisition, Thermo Scientific™ ExactFinder™ software version 2.5 was used for non-targeted compound identification. The HRAM data was screened for approximately 1000 known contaminants using the environmental and food safety (EFS) compound database and HRAM MS/MS spectral library. Automated feature scoring and filtering was based on chromatographic peak shape, mass error (ppm), and isotope pattern. Structures were tentatively assigned by library searching and later confirmed by analysis of authentic standards.

### Targeted Quantitation

Targeted quantitation was performed with the Thermo Scientific™ EQUAN MAX Plus™ online SPE and HPLC system. A 1 mL injection was loaded onto a Thermo Scientific™ Hypersil GOLD aQ™ column (20 x 2.1 mm, 12 µm particle size) and separated on a Thermo Scientific™ Accucore™ aQ analytical column (50 x 2.1 mm, 2.6 µm particle size) by gradient elution with methanol/water mobile phase.

### LC Conditions

Loading pump	Thermo Scientific™ Dionex™ UltiMate™ 3000 Quaternary Analytical Pump LPG-3400SD	
Flow rate	Isocratic 1 mL/min	
Solvent A (water)	98%	
Solvent B (methanol)	2%	
Total run time 1	8.4 min	
Analytical pump	UltiMate 3000 Binary Rapid Separation Pump HPG-3200RS	
Solvent A (water)	98%	
Solvent B (methanol)	2%	
Gradient elution	0.3 mL/min	
Gradient	Time	%A
	0	98
	1.5	98
	12.0	2
	15.0	2
	15.1	98
Total run time	18.4 min	
Autosampler	Thermo Scientific™ Open Accela™ autosampler	
Valve switching	At 1.5 min and 16.6 min	

The MS data was acquired in selected-reaction monitoring (SRM) mode on a Thermo Scientific™ TSQ Quantiva™ triple-stage quadrupole MS equipped with a HESI interface.

### MS Conditions

Ion mode	Positive HESI
Cycle time (s)	0.75
CID gas pressure (mTorr)	1.5
Spray voltage (V)	3500
Sheath gas (arb units)	60
Aux gas (arb units)	20
Sweep gas (arb units)	2
Ion transfer tube temp (°C)	350
Vaporizer temp (°C)	350
RF lens	Used calibrated RF lens values

Data processing, calibration, and quality control were performed using Thermo Scientific™ TraceFinder™ software version 3.1.

**HRAM Screening and Non-Targeted Identification**

Representative HRAM chromatograms of SPE extracts subjected to non-targeted screening for the identification of organic pollutants and selection of target compounds for quantitative analysis are shown in Figure 2.

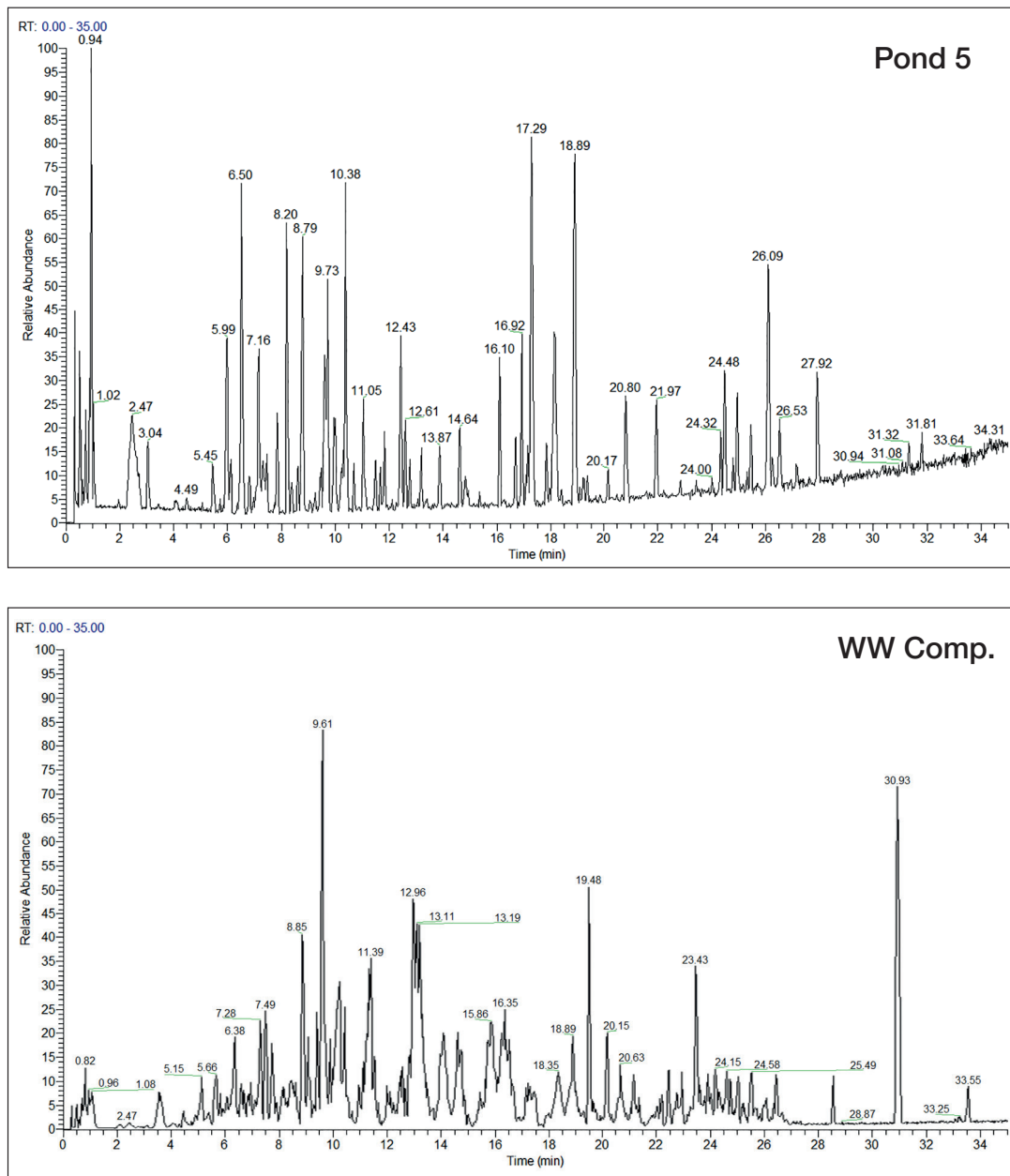

Figure 2. Representative HRAM chromatograms from non-targeted screening of SPE extracts from Pond 5 sample (top) and wastewater composite sample (bottom)

The non-targeted identification of fluridone in Pond 43 by EFS database screening and spectral library searching in ExactFinder software is demonstrated in Figure 3. Panel A shows an EFS database match for fluridone with a goodness of fit score of 0.93 between a modeled chromatographic peak and the observed peak. Panel B compares a modeled mass spectrum for the proposed pseudomolecular ion  $[C_{19}H_{14}F_3NO+H]^+$  and the averaged full-scan observed data with excellent mass accuracy (-0.31 ppm) at the mono-isotopic peak and a 100% isotope pattern score. In Panel C, library searching of the observed HRAM CID MS<sup>2</sup> spectrum returned a match to the EFS library entry for fluridone with a score of 70%.

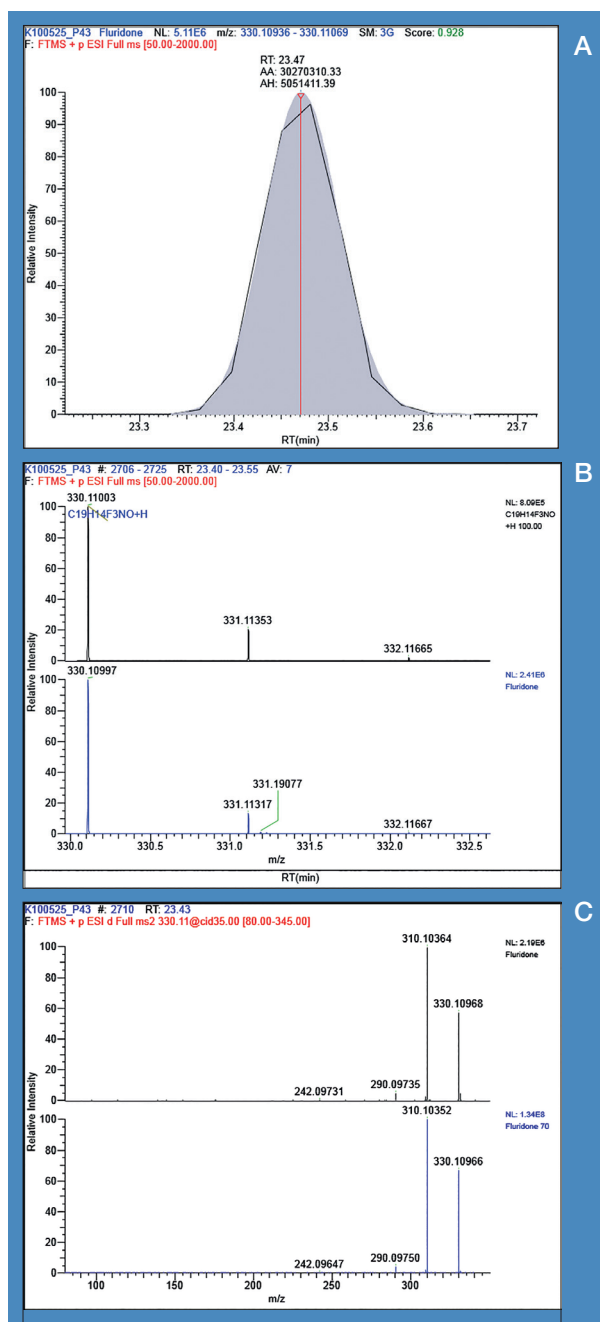

Figure 3. Non-targeted identification of fluridone in Pond 43. A) EFS database match for fluridone between a modeled chromatographic peak (gray area) and the observed peak (black trace). B) Comparison of a modeled mass spectrum for the proposed pseudomolecular ion  $[C_{19}H_{14}F_3NO]^M+H$  (blue) and averaged full-scan observed data (black). C) Library searching of the observed HRAM CID MS<sup>2</sup> spectrum (black) returns a match to the EFS library entry for fluridone (blue) with a score of 70%.

A partial list of compounds identified by non-targeted screening and the samples in which they were found are listed in Table 2.

Table 2. Compounds identified by non-targeted screening

Compound	Sample(s)
Atraton	Ponds 25, 43
Atrazine	Ponds 5, 25, 43, WWTP, WW Comp.
Atrazine-2-hydroxy	Pond 25
Carbamazepin	WWTP, WW Comp.
Carbendazim	WWTP
DEET	Ponds 5, 25, 43, WWTP, WW Comp.
Fluridone	Ponds 25, 43
Hydrocortisone	WWTP, WW Comp.
Mefluidide	Ponds 5, 25
Metolcarb	WWTP
Metoprolol	WWTP, WW Comp.
Promecarb	WW Comp.
Propranolol	WWTP, WW Comp.
Pyroquilon	Ponds 5, 25, WWTP, WW Comp.
Sulfamethoxazole	WW Comp.
Temeazepam	WW Comp.
Trimethoprim	WWTP, WW Comp.

WWTP = Wastewater treatment plant lagoon

WW Comp = Wastewater composite

### Targeted Quantitation by Online SPE LC/MS

Based on the results of the non-targeted screening, knowledge of chemical usage on the island, and readily available reference standards, an online SPE LC/MS method was developed to quantify the occurrence and distribution of wastewater- and turf-grass-management-derived organic pollutants on Kiawah Island.

Table 3 provides details of the online SPE LC/MS method, including the compounds monitored and the instrument limits of detection (LOD). Samples were quantitated down to the sub-ppt (ng/L) level.

Figure 4 displays the measured contaminant concentrations in representative storm and wastewater retention ponds.

Table 3. Compounds monitored by online SPE LC/MS, method parameters, and instrument limits of detection

Compound	Retention Time (min)	Precursor Mass (m/z)	Product Mass 1 (m/z)	CE Mass 1 (V)	Product Mass 2 (m/z)	CE Mass 2 (V)	LOD (ng/L)
Acephate	4.4	184.0	143	10	95	25	0.24
Allethrin	12.4	303.2	135	15	220	20	7.8
Ametryn	9.6	228.1	186	19	96	26	0.12
Atraton	8.2	212.2	170	19	100	29	0.12
Atrazine	9.7	216.1	174	16	104	29	0.12
Atrazine Desethyl	7.6	188.1	146	16	104	30	0.12
Atrazine-desisopropyl	6.5	174.1	132	17	104	28	0.24
Azoxystrobin	10.4	404.1	372	15	329	33	0.12
Benzotriazole	6.6	120.1	65	25	92	18	7.8
Bioresmethrin	13.2	339.2	171	14	293	15	62.5
Bloc (Fenarimol)	10.3	331.2	268	23	311	33	0.24
Carbaryl	9.3	202.0	145	12	127	30	0.12
Carbendazim	6.0	192.1	160	20	132	33	0.12
DEET	9.8	192.1	119	19	91	34	0.98
Etofenprox	13.6	394.0	177	14	135	26	3.9
Fenamiphos	11.2	304.1	217	25	234	17	0.12
Fluoxastrobin	11.0	459.1	427	18	188	38	0.5
Fluridone	10.3	330.1	309	37	310	29	0.12
Flutolanil	10.8	324.0	262	18	242	26	0.06
Formsulfuron	9.4	453.1	183	25	272	15	0.12
Halosulfuron-methyl	11.2	435.1	182	20	139	50	0.12
Imidacloprid	6.9	256.0	209	18	175	20	0.06
Iprodione_a	11.3	330.0	245	16	-	-	15.63
Iprodione_b	11.3	332.0	247	16	-	-	31.25
Metalaxyl	9.8	280.2	220	17	160	30	0.06
Metoprolol	7.3	268.2	116	17	191	20	0.24
Oxadiazon	12.4	345.1	303	15	220	20	3.9
Pramoxine	9.6	294.2	128	22	100	32	0.12
Prometron	9.1	226.1	142	24	170	19	0.12
Propanmide	10.8	256.0	173	25	209	20	0.12
Quinclorac	8.3	242.0	161	34	224	18	7.8
Thiencarbazone-methyl	8.7	391.0	359	10	230	20	3.9
Thiophanate-methyl	8.9	343.0	151	24	311	13	0.24
Tramadol	7.2	264.2	58	18	246	12	0.06



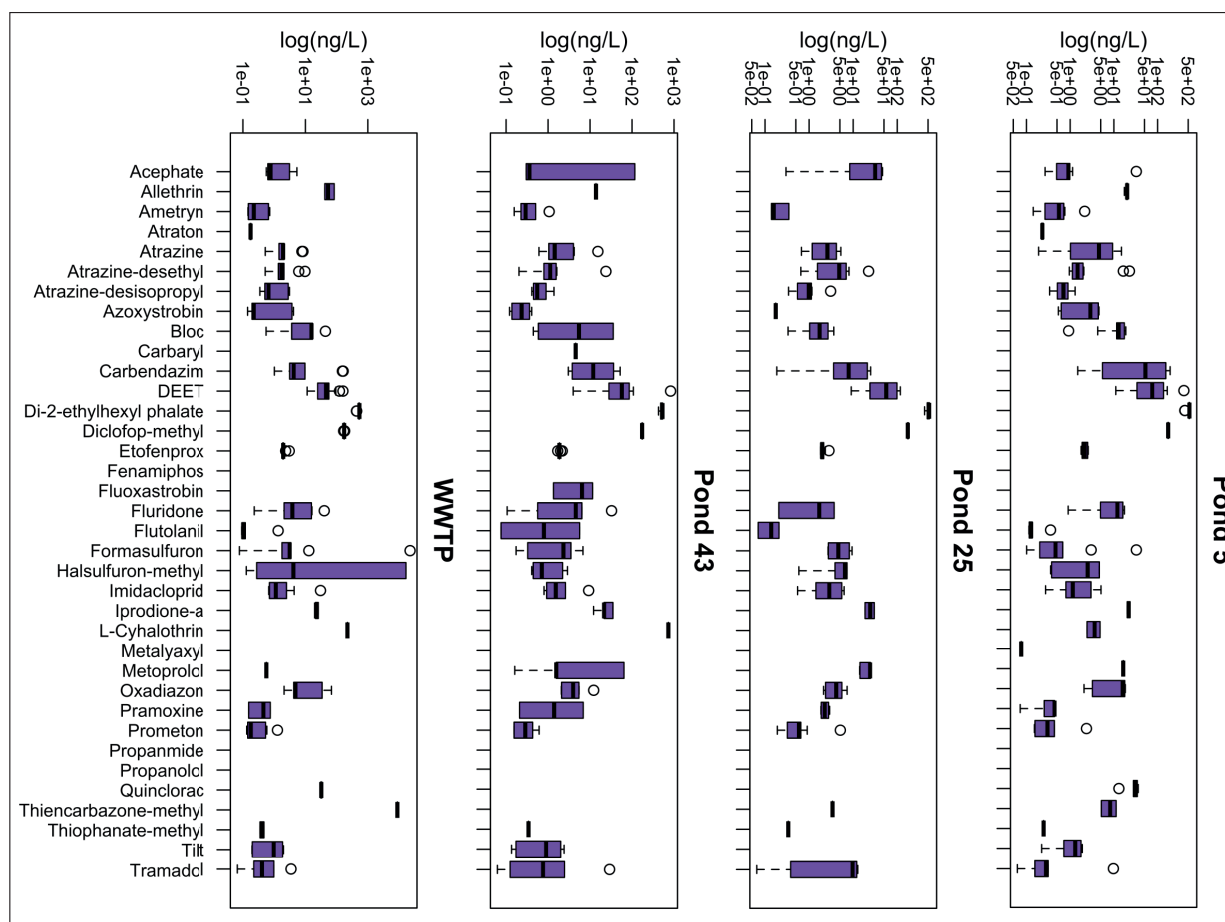

Figure 4. Boxplots depicting the measured contaminant concentrations in wastewater storage and storm water retention ponds on Kiawah Island. Purple boxes represent the interquartile range and the bar represents the median value. Hashed lines depict the range of the data and outliers are plotted as open circles.

## Conclusion

A multifaceted approach to identifying and quantifying non-targeted emerging compounds in environmental surface and ground water samples impacted by reclaimed water irrigation has been demonstrated.

- HRAM can be used to identify organic micropollutants in wastewater-impacted environments, golf course runoff, and storm water ponds.
- Online SPE coupled with a triple quadrupole MS can be used to quantitate micropollutants in water samples down to the sub-ppt (ng/L) level.
- Future work will include studying the toxicological impact of these compounds on aquatic species.

[www.thermofisher.com](http://www.thermofisher.com)

©2016 Thermo Fisher Scientific Inc. All rights reserved. All trademarks are the property of Thermo Fisher Scientific Inc. and its subsidiaries. This information is presented as an example of the capabilities of Thermo Fisher Scientific products. It is not intended to encourage use of these products in any manner that might infringe the intellectual property rights of others. Specifications, terms and pricing are subject to change. Not all products are available in all countries. Please consult your local sales representative for details.

**Africa** +43 1 333 50 34 0  
**Australia** +61 3 9757 4300  
**Austria** +43 810 282 206  
**Belgium** +32 53 73 42 41  
**Canada** +1 800 530 8447  
**China** 800 810 5118 (free call domestic)  
 400 650 5118

**Denmark** +45 70 23 62 60  
**Europe-Other** +43 1 333 50 34 0  
**Finland** +358 9 3291 0200  
**France** +33 1 60 92 48 00  
**Germany** +49 6103 408 1014  
**India** +91 22 6742 9494  
**Italy** +39 02 950 591

**Japan** +81 45 453 9100  
**Latin America** +1 561 688 8700  
**Middle East** +43 1 333 50 34 0  
**Netherlands** +31 76 579 55 55  
**New Zealand** +64 9 980 6700  
**Norway** +46 8 556 468 00  
**Russia/CIS** +43 1 333 50 34 0

**Singapore** +65 6289 1190  
**Spain** +34 914 845 965  
**Sweden** +46 8 556 468 00  
**Switzerland** +41 61 716 77 00  
**UK** +44 1442 233555  
**USA** +1 800 532 4752

**Thermo**  
 SCIENTIFIC

A Thermo Fisher Scientific Brand

# A Strategy for an Unknown Screening Approach on Environmental Samples using HRAM Mass Spectrometry

O. Scheibner,<sup>1</sup> P. van Baar,<sup>2</sup> F. Wode,<sup>2</sup> U. Dünnbier,<sup>2</sup> K. Akervik,<sup>3</sup> J. Humphries,<sup>3</sup> M. Bromirski<sup>1</sup>

<sup>1</sup>Thermo Fisher Scientific, Bremen, Germany; <sup>2</sup>Berliner Wasserbetriebe, Berlin, Germany;

<sup>3</sup>Thermo Fisher Scientific, Austin, TX, USA



## Overview

**Purpose:** Run a General Unknown Screening approach in an automated fashion.

**Methods:** Surface water samples from the city of Berlin, Germany were analyzed in full scan / AIF mode with a Thermo Scientific™ Exactive Plus™ mass spectrometer and analyzed in a widely automated workflow using Thermo Scientific TraceFinder™ and Thermo Scientific SIEVE™ software.

**Results:** Differences in the load of contaminants could be easily determined in the different samples; Easy detection and identification of a significant number of contaminants could be achieved.

## Introduction

The analysis of food and environmental samples for contaminants by LC-MS has become a quick and cost effective routine application when run in a targeted fashion, but this way it disregards events or circumstances not taken into account beforehand. Run in a non-targeted fashion, it is known to be laborious and time consuming, making it everything but a routine application. New generation software now links in quantitative and (unknown) screening approaches to one smoothly integrated workflow, tying together component detection capabilities of unknown screening workflows with the identification capabilities of targeted screening and quantification software. Here we show how one data set can serve for routine high throughput quantitative analysis and for versatile non-targeted investigations in a highly automated manner.

## Methods

### Sample Preparation

Four samples of surface water from different sources were taken and analyzed without any further treatment. In addition, one neat standard as control sample and one tap water sample as reference sample were run in the same sequence.

**FIGURE 1. Schematics of the EQuan online SPE and separation system.**

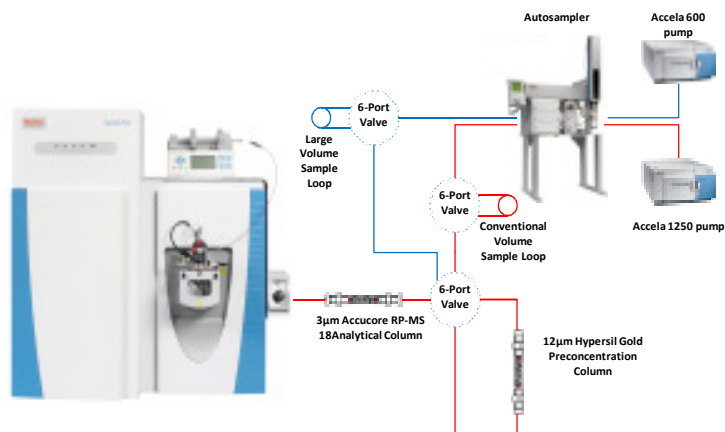

### Liquid Chromatography

For online sample concentration and chromatographic separation a Thermo Scientific EQuan™ system was used. A sample volume of 1000 µL was injected onto a Thermo Scientific Hypersil Gold™ 20 x 2.1 mm trapping column with subsequent elution onto a Thermo Scientific Accucore™ RP-MS C18 analytic column. A 6.7 minute solvent gradient was applied as shown in Fig 1. This resulted in a total cycle time of 15 minutes for sample injection, online concentration and chromatographic separation.

### Mass Spectrometry

For mass spectrometric detection a Thermo Scientific Exactive Plus mass spectrometer was used and run in full scan / all ion fragmentation (AIF) mode. In this mode full scans are permanently alternated with AIF fragmentation scans. A resolution setting of 70,000 (FWHM @  $m/z$  200) was used (see Fig. 2). A mass range of  $m/z$  103 to 900 was applied (resp.  $m/z$  70 to 870 and resolution setting 35,000 FWHM for the AIF scans) to be prepared for all possible contaminants. The mass axis of the system was calibrated with the standard calibration mix once prior measurement. Further optimization of the instrument (compound tuning) was not required.

**FIGURE 2. Exactive Plus method setup.**

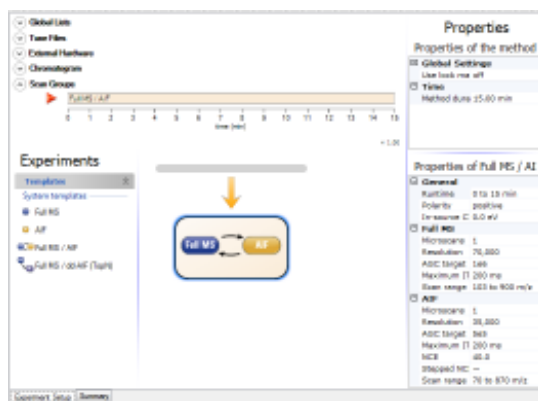

## Results

### Suspect Screening

The more simple way of screening is the suspect screen, using a large list of components possibly present in a sample. It avoids the critical step of condition free component detection, but works already without analytical standards which could serve for confirmation by providing valid retention time, ion ratios and more. In this case, a built-in database with about 1000 components was used, containing name, elemental composition and fragment information. Additionally, a matching spectral library containing roughly 4000 HRAM MS<sup>2</sup> spectra is available inside the application. As a result, isotopic pattern match, fragment search and MS<sup>2</sup> library search were used for result confirmation (see Fig. 3).

**FIGURE 3. Suspect screening result view.**

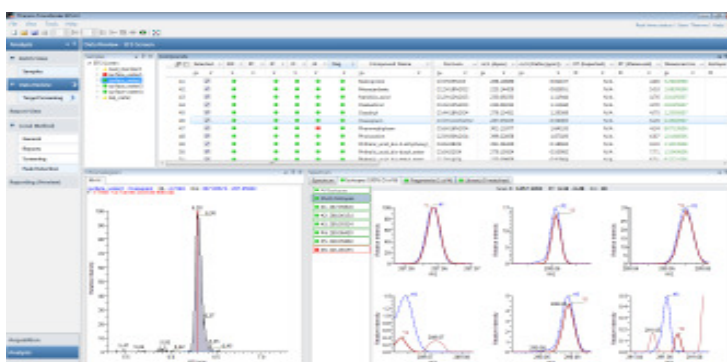

As to be expected, it was possible to identify a good number of contaminants, yielding a match on all three confirming points. On the other it was clear that this way of screening did not cover all possible compounds, as was visible from the neat standard (as used normally for target screening on these samples) measured in the same batch. A clear benefit could be seen in the fact that fragment information and library spectra were present for additional confirmation (see Fig. 4).

In addition, a larger database with 2900 components was applied still left open the question of contaminants not found because they may not be members of this list

**FIGURE 4. Three stages of confirmation in suspect screen: isotope pattern match, fragment search and library search; A: isotopic pattern overlay; B: fragment overlay; C: Library comparison.**

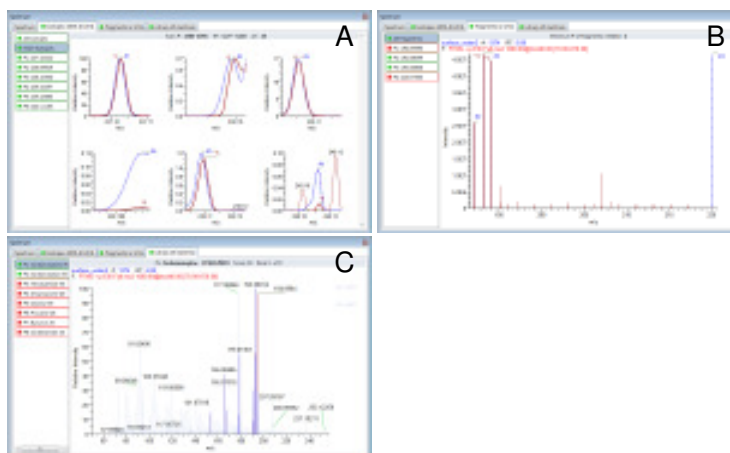

## Unknown Screening

As a consequence of the limitations of a suspect screen an unknown screening workflow was run. For this the measured sequence was transferred to the screening application SIEVE for unconditioned component detection. Since all necessary settings and parameters were transferred from TraceFinder to SIEVE automatically, the component detection process could be started immediately. As a result, 5000 components were detected. Since such a list contains all components regardless of their significance, refinement of this list was clearly needed. As part of the process, all samples were referenced against the tap water sample, so a simple filter could be applied to remove matrix and background signals from the result list, leaving 1829 components in the list. Application of a principal component analysis to this result revealed that three water samples were closely related, while one water sample (surface water 1, see Fig. 5) seemed to be rather different in its content, so the filter for significant components could be further refined.

**FIGURE 5. PCA result after filtering for significant differences.**

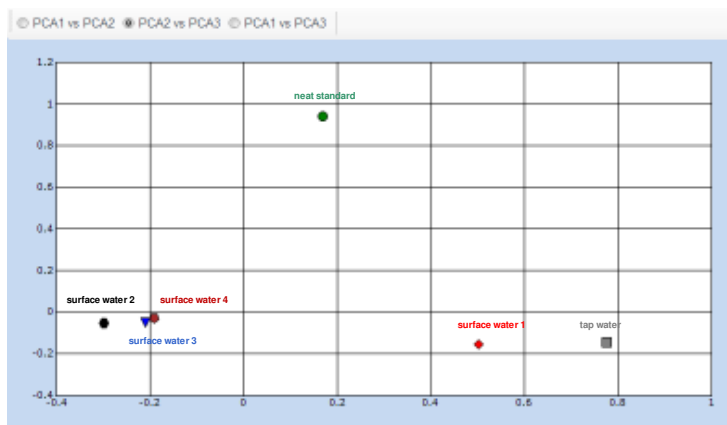



This time the filter was set to look only for significant changes in the samples surface water 1 and surface water 2. This reduced the list of components to 1671 which were sent to ChemSpider for identification. This search returned 1529 identifications. Closing of the SIEVE application automatically transferred this result list back to TraceFinder, where it was imported as a new compound database (see Fig. 6).

**FIGURE 6. Confirmation of the unknown screening results from SIEVE, propiconazole taken as an example: The extracted ion chromatogram at the determined retention time gives a clear signal free from interferences, the isotope pattern match shows close to perfect overlay.**

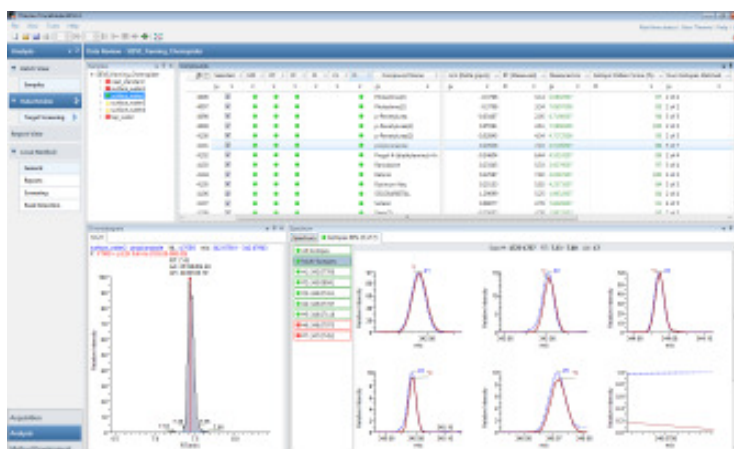

For confirmation and reporting of the results this compound database was used for a normal suspect screening. The advantage of looping back the results in TraceFinder was to be able to handle all data – target, suspect and unknown screen – in one application and to be able to use the same data review and report templates.

It became visible that some components were coeluting with higher amounts of matrix, but it was still possible to extract significant signals from the surrounding matrix, maintaining full mass accuracy despite the low signal intensity. Fig. 7 shows an example of the component Loxoprofen, where the surrounding matrix signals have roughly the same intensity as the first and second isotope signal of the compound. Still the analyte signals are clearly resolved from the background and matrix signals, so the compound can easily be detected and confirmed. Key to this clear separation of analyte and matrix signals is the high resolving power of  $R = 70,000 @ m/z 200$  used in this analysis.

**FIGURE 7. Importance of sufficient resolution for unambiguous identification of components: The monoisotopic signal (A) and the first isotope signal (B) are surrounded by matrix signals of similar intensity which are only separated by means of the high resolving power used.**

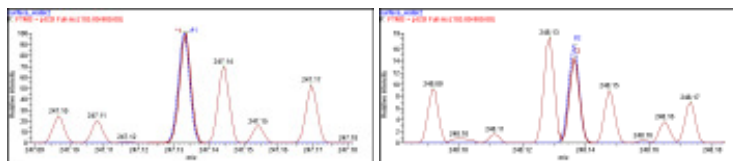

Since all final processing was done in one application, the results of target, suspect and unknown screening could easily be combined into one result, making result reporting and archiving one single step. Since all data transfer between the two applications is fully automated, Fig. 8 shows a short selection of compounds which had not been part of the initial target screening, but were found in the unknown screening process.

**FIGURE 8. Selection of additional contaminants not present in previous target and suspect screen.**

Compound Name	Formula	m/z (Apex)	m/z (Delta (ppm))	RT (Measured)	Isotopic Pattern Score (%)
Bisoprolol	C18H31NO4	326.2330	0.57	5.12	100
Candesartan	C24H20N6O3	441.1671	-0.50	6.56	100
Carbofuran	C12H15NO3	222.1127	-0.19	5.18	98
Dibenzylamine	C14H15N	198.1277	-0.66	7.31	98
Irbesartan	C25H28N6O	429.2401	-0.03	6.45	100
Loxoprofen	C15H18O3	247.1332	0.45	5.52	85
Mexacarbate	C12H18N2O2	223.1443	-0.06	5.53	96
Oxazepam	C15H11ClN2O2	287.0584	0.48	6.29	96
Propiconazole	C15H17Cl2N3O2	342.0774	0.21	7.43	89
Tramadol	C16H25NO2	264.1961	0.10	4.35	100

## Conclusion

In this example of environmental analysis we could show that it is possible to enhance the capabilities of target and suspect screening with its limitations by a streamlined general unknown screening with a high degree of automation from within one application. The resolving power of the Exactive Plus bench top Orbitrap MS system is the driving force behind the selectivity and reliability of the obtained results because this serves for the separation of the analyte peaks from background and matrix signals.

[www.thermofisher.com](http://www.thermofisher.com)

©2016 Thermo Fisher Scientific Inc. All rights reserved. Chemspider is a trademark of the Royal Society of Chemistry. All other trademarks are the property of Thermo Fisher Scientific and its subsidiaries. This information is presented as an example of the capabilities of Thermo Fisher Scientific products. It is not intended to encourage use of these products in any manners that might infringe the intellectual property rights of others. Specifications, terms and pricing are subject to change. Not all products are available in all countries. Please consult your local sales representative for details.

**Africa** +43 1 333 50 34 0  
**Australia** +61 3 9757 4300  
**Austria** +43 810 282 206  
**Belgium** +32 53 73 42 41  
**Canada** +1 800 530 8447  
**China** 800 810 5118 (free call domestic)  
400 650 5118

**Denmark** +45 70 23 62 60  
**Europe-Other** +43 1 333 50 34 0  
**Finland** +358 9 3291 0200  
**France** +33 1 60 92 48 00  
**Germany** +49 6103 408 1014  
**India** +91 22 6742 9494  
**Italy** +39 02 950 591

**Japan** +81 45 453 9100  
**Latin America** +1 561 688 8700  
**Middle East** +43 1 333 50 34 0  
**Netherlands** +31 76 579 55 55  
**New Zealand** +64 9 980 6700  
**Norway** +46 8 556 468 00  
**Russia/CIS** +43 1 333 50 34 0

**Singapore** +65 6289 1190  
**Spain** +34 914 845 965  
**Sweden** +46 8 556 468 00  
**Switzerland** +41 61 716 77 00  
**UK** +44 1442 233555  
**USA** +1 800 532 4752

**Thermo**  
S C I E N T I F I C

A Thermo Fisher Scientific Brand



# Enhancing General Unknown Screening with Data Independent Analysis on a Quadrupole Orbitrap Mass Spectrometry System

*Olaf Scheibner,<sup>1</sup> Matthias Ruff,<sup>2</sup> Bernadette Vogler,<sup>2</sup> Heinz Singer,<sup>2</sup> Maciej Bromirski<sup>1</sup>*

*<sup>1</sup>Thermo Fisher Scientific, Bremen, Germany*

*<sup>2</sup>Swiss Federal Institute of Aquatic Science and Technology, Dübendorf, Switzerland*



## Overview

**Purpose:** Enhance the unknown screening capabilities over the classical All Ion Fragmentation approach.

**Methods:** Environmental samples were measured with different scan methods for comparison.

**Results:** The DIA mode serves for the most versatile data suitable for unknown screening as well as for targeted quantitation at the same time

## Introduction

In residue analysis of environmental and food samples the need exists for the analysis of larger sets of analytes at the same time. Recent developments in scan speed of triple quadrupole mass spectrometry systems have fuelled this development, but even more the steadily increasing use of high resolution accurate mass (HRAM) mass spectrometry instrumentation (mainly TOF and Orbitrap™ based instruments) in residue analysis leads to numerous new options in this field as well into new challenges. One of these challenges is the confirmation step for the analytes, since precursor ion selected fragmentation comes to its technical limits in terms of the number of analytes and becomes impossible in case of analytes yet unknown or disregarded. The alternative of fragmentation without precursor ion selection (as “All Ion Fragmentation” or “MS<sup>E</sup>”) has proven to be very powerful but still faces some limitations in sensitivity of fragments for low concentrated components. In the Data Independent Acquisition (DIA) scan mode of a Thermo Scientific™ Q Exactive™ mass spectrometric system, the full scan mass range is divided into smaller ranges, typically in the range of 50 to 100 Daltons. This enhances the dynamic range for the fragment scans, resulting in significant higher sensitivity of the significant fragments needed for compound confirmation. At the same time all options for suspect screening or even General Unknown Screening remain fully available as in AIF.

## Methods

### Sample Preparation

Ground water, surface water and waste water samples were collected and prepared as described earlier<sup>1</sup>.

## Liquid Chromatography

For chromatographic separation, a HPLC system was used consisting of a CTC Pal autosampler (CTC analytics, Zwingen, Switzerland) and a Rheos 2200 pump (Flux Instruments, Switzerland). For separation a XBridge C18 column (50x2.1 mm, 3.5  $\mu\text{m}$  particle size) was used, applying a gradient of water and methanol, both acidified with 0.1% formic acid as given in Fig. 2.

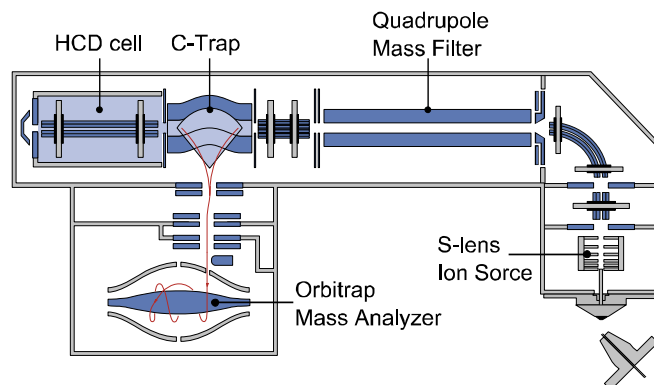

**FIGURE 1. Schematics of the Q Exactive mass spectrometer.**

## Mass Spectrometry

For mass spectrometric analysis a Q Exactive quadrupole Orbitrap mass spectrometer was used. The final setup was run in electrospray mode, the spray voltage being + 4000 V (positive mode) or - 3000 V (negative mode). The capillary temperature was at 320 °C. S-lens-level was set to 50, auxiliary gas flow rate was 15 (arbitrary units) and sheath gas flow rate was 40 (arbitrary units) for both ionization modes.

For data dependent experiments, full scan was recorded with a resolution of 140,000 @  $m/z$  200, while the data dependent MS<sup>2</sup> scans were recorded with a resolution of 17,500 @  $m/z$  200.

For AIF experiments, full scan was recorded with a resolution of 140,000 @  $m/z$  200 and the fragment spectra were recorded with a resolution of 17,500 @  $m/z$  200.

For DIA experiments, full scan was recorded with a resolution of 70,000 @  $m/z$  200, automated gain control was set to 500,000 and the maximal injection time was 200 ms. After the full scan different numbers of data independent MSMS spectra were recorded. Isolation widths and mass ranges were set according to Fig. 3. Resolution was set to 17,500 @  $m/z$  200, AGC to 200,000 and maximal injection time to 100 ms.



	Time	A%	B%	C%	D%	µl/min
0	0.00	90.0	10.0	0.0	0.0	200.0
1	4.00	50.0	50.0	0.0	0.0	200.0
2	17.00	5.0	95.0	0.0	0.0	200.0
3	25.00	5.0	95.0	0.0	0.0	200.0
4	25.10	90.0	10.0	0.0	0.0	200.0
5	29.00	90.0	10.0	0.0	0.0	200.0
6		100.0	0.0	0.0	0.0	200.0

**FIGURE 2. Gradient settings for the chromatographic separation.**

## Results

### All Ion Fragmentation (AIF)

First, data was acquired in AIF mode as described. After acquisition, extracted ion chromatograms were generated for the quasimolecular ion and specific ions for a number of compounds. Fig. 3 shows the XICs for Morphine and Sotalol as an example. Some of the fragments are missing completely and some show an irregular peak shape than the one of the quasimolecular ion, because the signal intensity is significant lower, although the concentration of the used standard was 500 ng/L.

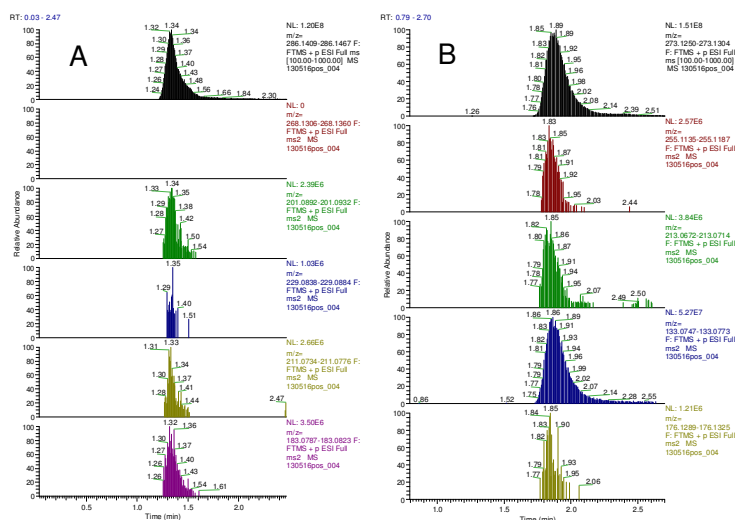

**FIGURE 3. Parent ions (top row) and fragment ions for Morphine (A) and Sotalol (B) in AIF mode**

## DIA Mode

In DIA mode different setups were evaluated. The assumption was that with more windows with smaller resulting isolation windows should yield better sensitivity on the fragment ion signals. Since the ion flux is bigger on the smaller masses while the mass range above  $m/z$  500 shows only low amount of matrix ions, the isolation windows were kept small in the range below  $m/z$  500 with only one bigger window for the range above  $m/z$  500 (see Fig. 4).

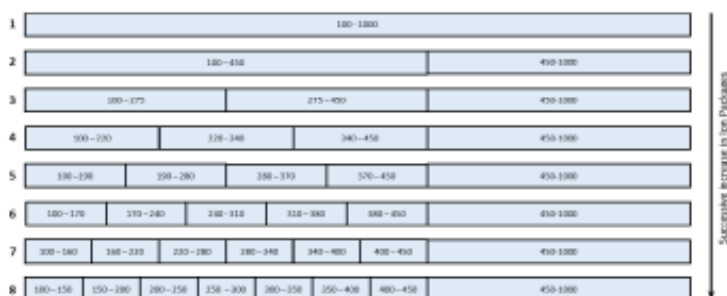

**FIGURE 4.** Isolation windows for different numbers of isolation windows in DIA mode; the top row shows the isolation window of the full scan (figure taken from Ref.1).

So in total there were eight experiments, starting with the AIF experiment (row 1), covering the whole mass range from  $m/z$  100 to 1000. The next experiment divided the mass range at  $m/z$  450 (row 2) and the following experiments subdivided this range into an increasing number of smaller isolation ranges, ending up with eight windows, of which seven had an isolation width of 50 Da (row 8).

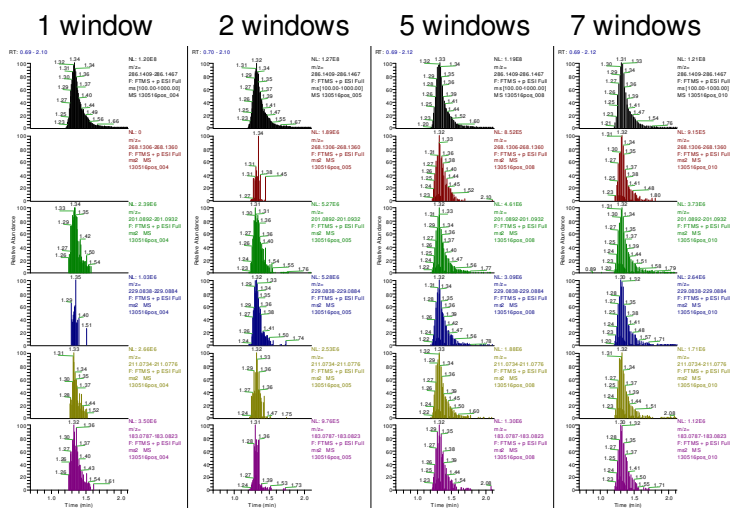

**FIGURE 5.** Influence of the number of DIA windows on the sensitivity of specific fragments on the example of Morphine in a neat standard.

As shown in Fig. 5, with increasing number of windows, leading to smaller window sizes, the fragment signals grow in intensity and their peak shape becomes similar to the shape of the signal from the quasimolecular ion, giving full evidence that the fragments are connected to the respective quasimolecular ion. Since there is no significant difference in signal quality between a 5 window experiment and a 7 window experiment, the favor for routine use could be on the 5 window experiment due to the total cycle time and the resulting data rate. As shown in Fig. 6, the different experiment times yield significantly different cycle times. It was no surprise, that the AIF experiment shows the shortest cycle time with little more than 250 ms, while the 8 window DIA experiment has roughly 850 ms. As expected, the 5 window experiment came up as a good compromise with about 650 ms. For comparison the so far used data dependent Top 5 MS<sup>2</sup> experiment is shown as well, which had a cycle time of more than 1 s, due to the small ion flux in the small isolation windows of 1 Da, which resulted in very long ion times.

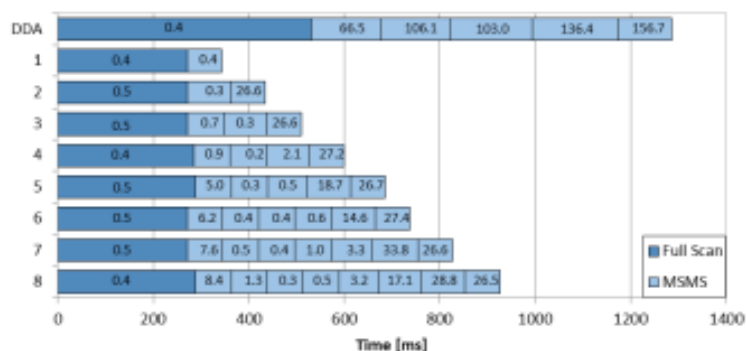

**FIGURE 6. Cycle times for different experiment types; DDA: data dependent Top 5 MS<sup>2</sup>; 1 – 8: DIA experiments with according number of windows as shown in Fig. 4; numbers in the boxes stand for average ion times.**

Another question was if not only the sensitivity, but also the selectivity could be increased using the DIA approach. The insect repellent DEET showed an interference in the fragment  $m/z$  119.0493. With one window (i.e. AIF) a clear shoulder was visible which was not present in the signal of the parent ion. This interference signal did not change at first with increasing the number of windows for DIA, but with eight windows (isolation width of 50 Da) suddenly the chromatographic peak showed the same shape as the parent peak from the full scan. This indicates, that it is possible to even increase the selectivity with the larger number of isolation windows in DIA. This is shown clearly in Fig. 7.

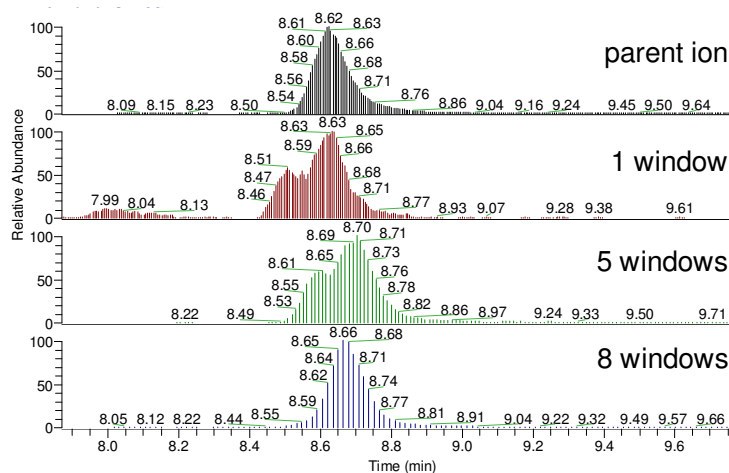

**FIGURE 7. Interferences filtered out by DIA with higher number of isolation windows on the Example of DEET.**

## Conclusion

It could be shown, that with DIA the sensitivity and selectivity of fragment ions can be increased significantly. Since this is a technique without targeted precursor ion selection, no signals are filtered out. This enables all possibilities for post acquisition processing in a targeted and untargeted approach the same way, so prerequisites for General Unknown Screening are given without compromise.

## References

1. B. Vogler, Master Thesis, University of Zurich, Switzerland, 2013

[www.thermofisher.com](http://www.thermofisher.com)

©2016 Thermo Fisher Scientific Inc. All rights reserved. All trademarks are the property of Thermo Fisher Scientific and its subsidiaries. This information is presented as an example of the capabilities of Thermo Fisher Scientific products. It is not intended to encourage use of these products in any manners that might infringe the intellectual property rights of others. Specifications, terms and pricing are subject to change. Not all products are available in all countries. Please consult your local sales representative for details.

**Africa** +43 1 333 50 34 0  
**Australia** +61 3 9757 4300  
**Austria** +43 810 282 206  
**Belgium** +32 53 73 42 41  
**Canada** +1 800 530 8447  
**China** 800 810 5118 (free call domestic)  
400 650 5118

**Denmark** +45 70 23 62 60  
**Europe-Other** +43 1 333 50 34 0  
**Finland** +358 9 3291 0200  
**France** +33 1 60 92 48 00  
**Germany** +49 6103 408 1014  
**India** +91 22 6742 9494  
**Italy** +39 02 950 591

**Japan** +81 45 453 9100  
**Latin America** +1 561 688 8700  
**Middle East** +43 1 333 50 34 0  
**Netherlands** +31 76 579 55 55  
**New Zealand** +64 9 980 6700  
**Norway** +46 8 556 468 00  
**Russia/CIS** +43 1 333 50 34 0

**Singapore** +65 6289 1190  
**Spain** +34 914 845 965  
**Sweden** +46 8 556 468 00  
**Switzerland** +41 61 716 77 00  
**UK** +44 1442 233555  
**USA** +1 800 532 4752

**Thermo**  
SCIENTIFIC

A Thermo Fisher Scientific Brand

# Qualitative and Quantitative Analysis of Contaminants of Emerging Concern in Biosolids Using Dilute-and-Shoot UHPLC-Orbitrap MS Method

Charles Yang,<sup>1</sup> Ahmed Mostafa,<sup>2</sup> Shelly Bonte-Gelok,<sup>3</sup> Jonathan Beck,<sup>1</sup> Maciej Bromirski<sup>1</sup> and Dipankar Ghosh<sup>1</sup> and Paul Yang<sup>3</sup>

<sup>1</sup>Thermo Fisher Scientific, San Jose, CA, USA; <sup>2</sup>Department of Chemistry and Biology, Ryerson University, Toronto, Ontario, Canada; <sup>3</sup>Ontario Ministry of the Environment, Etobicoke, Ontario, Canada

## Overview

**Purpose:** Develop a workflow to (1) do quantitatively analyze contaminants of emerging concerns (CECs) in biosolids samples, and (2) screen for 381 targeted CECs in samples.

**Methods:** Samples were prepared by ultrasonic extraction and analyzed by high performance liquid chromatography-Orbitrap mass spectrometry (HPLC-Orbitrap MS).

**Results:** Quantitative results of CECs in typical biosolids samples are presented. Targeted screening of CECs in biosolids showed the presence of different categories of CECs including parent pharmaceuticals and personal care products (PPCPs), e.g., DEET, Triclosan (TCS), Triclocarban (TCC), musks, Carbamazepine (CBZ), their degradation products, and surfactants.

## Introduction

A rapid dilute-and-shoot method for the quantitative determination of targeted CECs, e.g., endocrine disrupting chemicals, pharmaceuticals, personal care products, as well as their degradation by-products has been developed. Using ultrasonic based sample preparation and HPLC-Orbitrap MS analysis without any sample cleanup, this method has been optimized for the determination of 49 CECs present in biosolids and terrestrial biomes exposed to biosolids amended soils (BAS). The quantitative information on the CECs in biosolids and biological tissues would allow for the assessment, when and where appropriate, of potential uptake and bioaccumulation. In addition, full scan HRMS data provides information on the possible environmental transformation by-products for possible environmental accumulation and ecological effects that would not be available with other technology.

## Methods

### Sample Preparation

For this study, model biosolid samples and biosolids amended samples were used in the evaluation of the method. Grab biosolid samples were contained in 1L-amber bottles without headspace and stored in dark, cold storage (4°C) until analysis. The same biosolids were also used to prepare BAS at Ryerson University and used to observe the fate of CECs from October 2013 to March 2014.

Neat standards of native target compounds were purchased from Sigma-Aldrich (Oakville, ON, Canada). Deuterium (D) and <sup>13</sup>C-labelled standards were purchased from CDN Isotopes (Pointe-Claire, QC, Canada) and Cambridge isotope Laboratories (Andover, MA, US). Five levels of analytical standard solutions were prepared by diluting intermediate solutions with CH<sub>3</sub>OH HPLC grade acetonitrile (CH<sub>3</sub>CN) and methanol (CH<sub>3</sub>OH) were purchased from Thermo Fisher Scientific (Ottawa, ON, Canada). High purity water used for aqueous mobile phases and sample preparation was produced by passing reverse osmosis water through a Thermo Scientific™ Barnstead™ Nanopure™ water purification system (Mississauga, ON, Canada).

Biosolids and BAS samples were dried in fumehood for 96 hours, sieved through a 200 micron mesh, homogenized and stored in freezer until ready for extraction. Sample extraction was done using 5.0 g of sample in glass centrifuge tubes, 20 mL of the extraction solvent A (acetonitrile: 0.1% acetic acid in H<sub>2</sub>O, 70:30 (v/v), 1 mM ethylenediaminetetraacetic acid (EDTA) and isotopically labelled surrogates. The tubes were shaken for 5 min and sonicated for 20 min, shaken for another 5 min and centrifuged for 8 min at 3500 rpm. The supernatant was transferred into another glass centrifuge tube (50 mL). The cycle was repeated using solvent B (acetonitrile:Acetone, 50:50 (v/v)). The combined extracts volumes were brought up to 50 mL, centrifuged for 3 min at 5000 rpm and 10 mL of the extract was evaporated to dryness. The residues were dissolved in 100 μL of the internal standard then injected into the HPLC-Orbitrap MS for analysis.



## High Pressure Liquid Chromatography Separation

Sample analysis was achieved on a Thermo Scientific™ Dionex™ UltiMate™ 3000 HPLC consisting of a HRG-3400RS binary pump, WPS-3000 autosampler, and a TCC-3400 column compartment. Separation was made by injecting 5 mL extracts into a Thermo Scientific™ Betasil™ and a Thermo Scientific™ Hypersil™ Gold, 2.1x100 mm column, respectively, for positive and negative mode Orbitrap MS analysis. Three HPLC separations were used for the analysis of PPCPs and their by-products.

**TABLE 1. HPLC mobile phase and gradient used in the analysis**

Column oven temperature: 35°C; Flow rate: 450 mL/min				
Mobile phase (Positive)	A: 5 mM HCOONH <sub>4</sub> /0.1% HCOOH in 10:90/CH <sub>3</sub> OH:H <sub>2</sub> O B: 90:10/CH <sub>3</sub> OH:H <sub>2</sub> O			
Mobile phase (Negative I)	A: 10:90/CH <sub>3</sub> CN:H <sub>2</sub> O, pH 6.95±0.3 B: CH <sub>3</sub> CN			
Mobile phase (Negative II)	A: 5 mM CH <sub>3</sub> COONH <sub>4</sub> in 10:90/CH <sub>3</sub> CN:H <sub>2</sub> O, pH 6.95±0.3 B: CH <sub>3</sub> CN			
HPLC Gradient	Time (min)	% A	% B	Curve
	0.0	95	5	5
	2.0	25	75	5
	10.0	5	95	7
	15.0	5	95	5
15.2	95	5	5	

## Mass Spectrometry

The HPLC was interfaced to a Thermo Scientific™ Exactive Plus™ Orbitrap™ MS using a heated electrospray ionization (HESI) interface. The Orbitrap MS system was tuned and calibrated in positive and negative modes by infusion of standard mixtures of MSCAL5 and MSCAL6. High purity nitrogen (>99%) was used in the ESI source (35 L/min). Spray voltages used were 2500 and -3200 V for positive and negative modes, respectively. Mass spectrometric data was acquired at a resolving power of 140,000 (full-width-at-half-maximum, at  $m/z$  200,  $R_{FWHM}$ ), resulting a scanning rate of > 1.5 scans/sec when using automatic gain control target of  $1.0 \times 10^6$  and a C-trap inject time of 100 msec.

## Data Analysis

Thermo Scientific™ TraceFinder™ software were used to perform quantitative analysis for 56 PPCPs. The same software was also used to perform non-targeted screening along with a database of 312 compounds consisting of PPCPs and their metabolites, steroids, hormones, perfluorohydrocarbons, surfactants, and organophosphorus flame retardants. Quantitative analysis identified targeted compounds by retention time (RT) obtained from extracted ion chromatogram (XIC) using a mass extraction window (MEW) of 5 ppm. Non-targeted screening searched compounds listed in a database using (M+H)<sup>+</sup>, (M+NH<sub>4</sub>)<sup>+</sup> and (M+Na)<sup>+</sup> adduct ions in the positive mode and (M-H)<sup>-</sup> quasi-molecular ion in the negative mode, and created XICs for each compound. Those non-targeted analytes with area counts larger than 200,000 (approximately 25–50 pg/mL depending on compound), had a 5 ppm mass accuracy for the mono-isotopic mass (M) and two isotopic peaks ((M+1) and (M+2)), and a relative intensity of 90% ± 10% from the theoretical values were considered to be identified. Results obtained from TraceFinder software were also exported to Thermo Scientific™ SIEVE™ software to carry out a ChemSpider™ search.

**FIGURE 1. Optimization of extraction solvent**

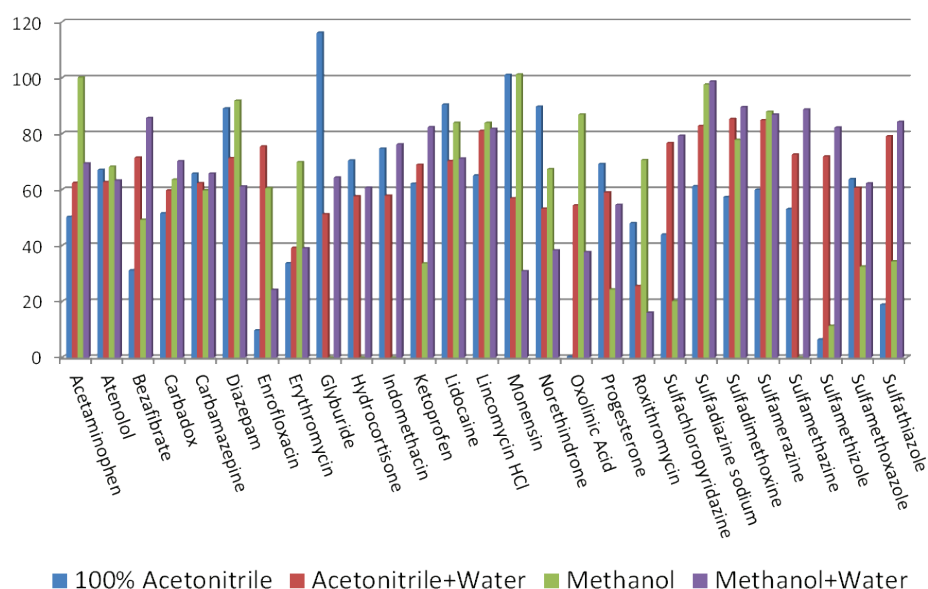

Current extraction procedure has been validated for the analysis of 49 targeted compounds. Table 2 showed the performance data for these 49 PPCPs.

**TABLE 2. Method performance for targeted compound analysis. MDL (method detection limit) is derived from eight replicate spikes. (RSD: relative standard deviation; REC: recovery)**

Compound	RSD	MDL	Rec	Compound	RSD	MDL	Rec
19-Norethisterone	10	27	75	Hydrocortisone	41	42	56
Acetamidophenol	2.4	21	57	Ibuprofen	3.7	51	114
α-Estradiol	13	572	112	Indomethacin	4.6	15	92
α-Ethynyl Estradiol	3.9	68	97	Ketoprofen	16	18	64
Atenolol	4.7	39	91	Lidocaine	8.4	6	73
β-Estradiol	3	121	98	Lincomycin HCl	7.4	11	80
Bisphenol A	20	135	76	Naproxen	13	44	95
Caffeine	9.9	26	72	Norfloxacin	9.9	27	76
Carbadox	16	99	88	Ofloxacin	6.1	39	89
Carbamazepine	8.2	6	80	Oxolinic Acid	8.7	63	100
Chloramphenicol	5.6	7	73	Oxybenzone	14	14	54
Chlorotetracycline	9.3	110	132	Oxytetracycline HCl	8.3	57	128
Ciprofloxacin	5.6	35	88	Progesterone	5.9	20	96
Clofibrilic acid	1.9	7	94	Roxithromycin	13	65	141
DEET	16	10	67	Sulfachloropyridazine	10	14	76
Diazepam	8	33	57	Sulfadiazine sodium	15	269	50
Diclofenac sodium	6.6	16	88	Sulfadimethoxine	9.4	11	66
Doxycycline HCl	15	94	87	Sulfamerazine	17	22	73
Enrofloxacin	10	56	78	Sulfamethazine	7.1	9	74
Equilin	3.9	20	98	Sulfamethizole	6.7	9	74
Esterone	2.8	23	93	sulfamethoxazole	7.1	12	91
Estriol	9.6	81	94	Sulfathiazole	9.4	13	80
Gemfibrozil	12	15	116	Trimethoprim	20	70	98
Glipizide	7.7	9	78	Tylosin	9.9	287	97

### Quantitative Determination of PPCPs in Biosolids Samples

Quantitative determination of targeted PPCPs in biosolids are shown in Table 3. Five compounds, i.e., bisphenol A, caffeine, CBZ, TCC and TCS, were found in all six samples at the high ppb range.

Table 4 showed targeted screening results from the same samples with 100% occurrence. These include known treatment by-products of CBZ, TCC and TCS, artificial sweeteners, surfactants, musks were abundant along with organophosphorus flame retardant and quaternary ammonium surfactants.

**TABLE 3. Results of quantitative determination of different biosolids**

Compound	#1	#2	#3	#4	#5	#6
Bisphenol A	30,200	9,220	3,680	84,280	85,700	47,750
Caffeine	356	2,500	807	1,230	1,260	1,170
Carbamazepine	3,490	3,520	3,600	3,300	3,600	3,500
Clofibric acid	91	73	36	84	34	106
DEET	174	218	190	273	214	210
Esterone	1,984	2,400	938	<MDL	631	<MDL
Estriol	<MDL	955	<MDL	<MDL	<MDL	<MDL
Lidocaine	190	105	80	123	94	<MDL
Oxybenzone	326	81	31	<MDL	418	484
Triclocarban*	2,947	2,770	2,040	1,510	2,080	1,130
Triclosan*	3,290	3,070	2,290	1,680	2,580	1,390

\*Semi-quantitative results

**TABLE 4. Results of targeted screening of different biosolids**

Compound Name	RT (Min.)	Compound Name	RT (Min.)
Ethofumesate	1.6	Dihexadecyldimethylammonium	11.8
Fenofibric-Acid	3.8	Dodecyltrimethylammonium	10.1
Metoprolol	3.9	Galaxolide	11.7
Neotame	2.5	Galaxolidone	11.2
Spiroxamine	10.9	Hexadecyltrimethylammonium	10.8
Sucralose	2	Isoproturon	2.5
4-Chloro-2-(2,4-dichloro-phenoxy)-phenol	10.6	Mefenamic acid	9.2
4- & 6-Chloro-triclosan	10.9	Methyl-Benzotriazol	5.1
Acridine	3.1	Metoprolol	3.8
acridone-N-carbaldehyde	5.8	Myristyltrimethylammonium	10.6
Benzotriazol	3.4	N-Desvenlafaxine	3.5
Benzylmethyl-dodecylammonium	10.4	Nonylphenol diethoxylate	11.6
Benzylmethyl-hexadecylammonium	10.9	Nonylphenol monoethoxylate	9.2
Benzyl-dimethyl-tetradecylammonium	10.7	O-Desvenlafaxine	3.5
Carbamazepin-10,11-dihydroxy	5.3	Phenazon (Antipyrine)	7.5
Carbamazepine-10,11-epoxid	5.4	Primidon	3.5
Dibutyl Phthalate	11.1	Tonalide	11.7
Didecyl-dimethylammonium	10.8	Tramadol	3.5
Diethyl Phthalate	9.3	Tributyl Phosphate	11.1
Diethylhexyl Phthalate	12.8		

## Conclusion

- Quantitative results of PPCPs were obtained using HPLC-Orbitrap MS.
- Semi-quantitative results showed the presence of surfactants, musks and treatment by-products in biosolids.
- Efforts to obtain analytical standards to complete the studies are on-going.

## Acknowledgements

Dr. Ahmed Mostafa would like to acknowledge Canadian Water Network funding support for his postdoctoral fellowship.

[www.thermofisher.com](http://www.thermofisher.com)

©2016 Thermo Fisher Scientific Inc. All rights reserved. Microsoft® and Excel® are trademarks of Microsoft Corporation. All other trademarks are the property of Thermo Fisher Scientific and its subsidiaries. This information is presented as an example of the capabilities of Thermo Fisher Scientific products. It is not intended to encourage use of these products in any manners that might infringe the intellectual property rights of others. Specifications, terms and pricing are subject to change. Not all products are available in all countries. Please consult your local sales representative for details.

---

<b>Africa</b> +43 1 333 50 34 0	<b>Denmark</b> +45 70 23 62 60	<b>Japan</b> +81 45 453 9100	<b>Singapore</b> +65 6289 1190
<b>Australia</b> +61 3 9757 4300	<b>Europe-Other</b> +43 1 333 50 34 0	<b>Latin America</b> +1 561 688 8700	<b>Spain</b> +34 914 845 965
<b>Austria</b> +43 810 282 206	<b>Finland</b> +358 9 3291 0200	<b>Middle East</b> +43 1 333 50 34 0	<b>Sweden</b> +46 8 556 468 00
<b>Belgium</b> +32 53 73 42 41	<b>France</b> +33 1 60 92 48 00	<b>Netherlands</b> +31 76 579 55 55	<b>Switzerland</b> +41 61 716 77 00
<b>Canada</b> +1 800 530 8447	<b>Germany</b> +49 6103 408 1014	<b>New Zealand</b> +64 9 980 6700	<b>UK</b> +44 1442 233555
<b>China</b> 800 810 5118 (free call domestic) 400 650 5118	<b>India</b> +91 22 6742 9494	<b>Norway</b> +46 8 556 468 00	<b>USA</b> +1 800 532 4752
	<b>Italy</b> +39 02 950 591	<b>Russia/CIS</b> +43 1 333 50 34 0	

**Thermo**  
S C I E N T I F I C

A Thermo Fisher Scientific Brand



# Routine, Targeted and Non-Targeted Analysis of Environmental Contaminants of Emerging Concern – Development and Validation of a UHPLC Orbitrap MS Method

P. Yang,<sup>2</sup> C. Yang,<sup>1</sup> T. Nguyen,<sup>3</sup> V. Pileggi,<sup>2</sup> K. Akervik,<sup>1</sup> C. Hao,<sup>2</sup> X. Zhao,<sup>2</sup> S. Thach,<sup>2</sup> J. Newman,<sup>2</sup> Y. Lu,<sup>2</sup> S. Kleywegt,<sup>2</sup> S. Tabe,<sup>2</sup> R. Farnood,<sup>2</sup> J. Beck,<sup>1</sup> M. Bromirski<sup>1</sup> and D. Ghosh<sup>1</sup>

<sup>1</sup>ThermoFisher Scientific, San Jose, CA; <sup>2</sup>Ontario Ministry of the Environment, Ontario, Canada;

<sup>3</sup>University of Toronto, Ontario, Canada





Figure 2. Schematic of the WWTP identifying the three sampling locations.

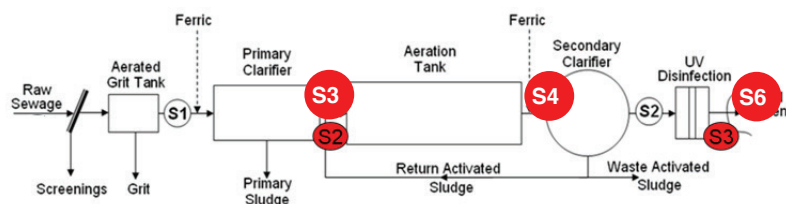

### Chemicals, Sample Preparation and UHPLC Orbitrap MS Analysis

HPLC grade acetonitrile ( $\text{CH}_3\text{CN}$ ) and methanol ( $\text{CH}_3\text{OH}$ ) were purchased from Fisher Scientific (Ottawa, ON, Canada). High purity water used for aqueous mobile phases and sample preparation was produced by passing reverse osmosis water through a Thermo Scientific™ Barnstead™ Nanopure™ water purification system (Mississauga, ON, Canada). Laboratory Services NBranch (LaSB) method E3454<sup>1</sup> was used to prepare samples for targeted compound analysis and non-targeted compound screening. Waters OASIS® (Mississauga, ON, Canada) HLB solid phase extraction (SPE) cartridge (6 cc, 500 mg) was used in the extraction. Method E3454 has been accredited by the Canadian Association for Laboratory Accreditation (CALA) since 2004.

Neat standards of native target compounds were purchased from Sigma-Aldrich (Oakville, ON, Canada). Deuterium (D) and <sup>13</sup>C-labelled standards were purchased from CDN Isotopes (Pointe-Claire, QC, Canada) and Cambridge isotope Laboratories (Andover, MA, US). Native and isotopically-labelled intermediate standard solutions were prepared by mixing the corresponding stock solutions in  $\text{CH}_3\text{OH}$ . Five levels of analytical standard solutions were prepared by diluting intermediate solutions with  $\text{CH}_3\text{OH}$ .

Sample analysis was achieved on a Thermo Scientific™ Dionex™ UltiMate™ 3000 UHPLC consisting of a HRG-3400RS binary pump, WPS-3000 autosampler, and a TCC-3400 column compartment. Separation was made by injecting 5  $\mu\text{L}$  extracts into a Thermo Scientific™ Betasil™ column (positive mode) and an Agilent XDB C-18, 2.1x100 mm coreshell technology column, respectively, for positive and negative mode Orbitrap MS analysis. Details of the UHPLC analysis is available on request (Ref. 1). The UHPLC was interfaced to a Thermo Scientific™ Exactive™ Plus Orbitrap MS using a heated electrospray ionization (H-ESI II) interface. The Orbitrap MS system was tuned and calibrated in positive and negative modes by infusion of standard mixtures of MSCAL5 and MSCAL6. High purity nitrogen (>99%) was used in the ESI source (35 L/min). Spray voltages used were 2,500 and 3,200 V for positive and negative modes. Mass spectrometric data was acquired at a resolving power of 140,000 (defined as full-width-at-half-maximum peak width at  $m/z$  200,  $R_{\text{FWHM}}$ ), resulting a scanning rate of > 1.5 scans/sec when using automatic gain control target of  $1.6 \times 10^6$  and a C-trap inject time of 50 msec.

### Data Analysis

TraceFinder software was used to perform targeted, quantitative analysis of 61 CECs. The same software was also used to perform non-targeted screening along with a database of 312 CECs consisting of pharmaceutically active compounds, steroids, hormones, surfactants and perfluorohydrocarbon. TraceFinder software is used to search for adduct ions  $(\text{M}+\text{H})^+$ ,  $(\text{M}+\text{NH}_4)^+$  and  $(\text{M}+\text{Na})^+$  in the positive mode and  $(\text{M}-\text{H})^-$  molecular ion in the negative mode for compounds listed in the database. The software then creates an extracted ion chromatogram (XIC) using a mass extraction window (MEW) of 5 ppm. Analytes were automatically identified using an XIC area threshold of 50,000 (approximately 25–50 pg/mL (ppt) depending on compound), a 5 ppm mass accuracy for the mono-isotopic mass (M) and an isotopic (M+1) peak threshold of 90% with relative intensity variation of < 10%. Typical screening time was about 65 sec/sample using the 312 CEC database. Analytical results were interpreted manually for the top 10<sup>th</sup> percentile compounds and exported to Microsoft Excel® with which analytical data were compiled for the presentation.

## Results

### Targeted Compound Analysis

Table 1 lists results obtained from targeted compound analysis in the collected samples along with their respective method detection limits (MDL). A total of 21 of the 61 target compounds were found in the ten samples analyzed.

**FIGURE 3. Sample preparation and analysis using UHPLC-Orbitrap MS.**

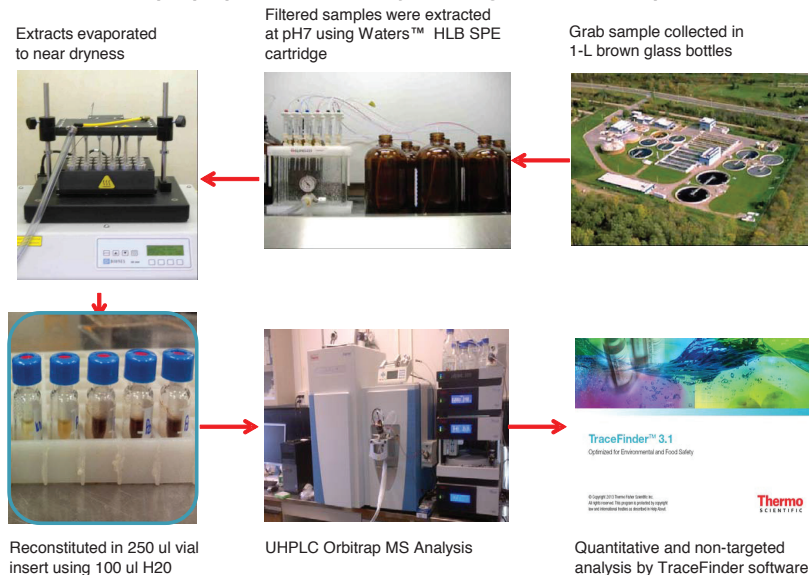

**TABLE 1. Results of targeted compound analysis.**

Compound	MDL	#1, PS	#1, PS	#2, PS	#1, TWAS	#1, PE	#2, PE	#2, SE	#1, FE	Permate	Permate
	ng/L										
Acetamidophenol	100	<MDL	<MDL	578.5	111.5	1952.5	4026.5	<MDL	<MDL	105.0	<MDL
Atenolol	50	<MDL	<MDL	<MDL	<MDL	143.5	579.5	288.5	<MDL	<MDL	<MDL
Atorvastatin	10	147.5	3419.5	3417.5	107.5	<MDL	165.0	<MDL	3419.5	110.0	72.5
Bezafibrate	20	<MDL	<MDL	<MDL	49.0	53.0	109.0	23.0	<MDL	<MDL	<MDL
Caffeine	20	147.5	75.5	525.0	34.5	4426.5	<MDL	35.0	<MDL	288.0	105.5
Carbadox	200	<MDL	<MDL	<MDL	<MDL	<MDL	<MDL	<MDL	<MDL	<MDL	<MDL
Carbamazepine	2	332.5	<MDL	<MDL	107.0	24.0	235.5	115.0	<MDL	262.0	183.5
Ciprofloxacin	100	918.0	289.0	289.5	316.0	304.5	319.5	315.0	298.5	606.5	536.0
DEET	150	<MDL	<MDL	<MDL	<MDL	<MDL	338.5	<MDL	<MDL	<MDL	<MDL
Diclofenac sodium	100	<MDL	<MDL	<MDL	166.5	<MDL	148.5	<MDL	<MDL	<MDL	<MDL
Hydrocortisone	5	1781.5	<MDL	<MDL	7.5	8.0	11.0	9.5	<MDL	976.5	636.5
Lidocaine	10	38.0	<MDL	<MDL	114.0	<MDL	118.5	54.5	<MDL	32.5	35.5
Oxolinic Acid	20	<MDL	<MDL	<MDL	81.0	<MDL	125.5	49.0	<MDL	<MDL	<MDL
Progesterone	20	29.0	<MDL	<MDL	<MDL	<MDL	957.5	<MDL	<MDL	108.5	<MDL
Bisphenol A	200	4458.0	617.5	1252.5	522.0	1211.0	1675.5	213.0	249.0	3621.5	3383.5
Equilin	50	1619.0	449.5	<MDL	<MDL	678.0	1531.0	1337.0	<MDL	1441.0	345.5
Estriol	200	<MDL	472.5	<MDL	1006.0	216.5	<MDL	<MDL	<MDL	<MDL	<MDL
Gemfibrozil	10	<MDL	121.5	193.0	281.0	174.0	125.0	77.5	127.0	260.0	227.0
Oxybenzone	50	158.5	346.0	<MDL	170.0	237.0	166.5	170.0	196.0	159.5	159.5
Triclocarban	50	<MDL	734.0	429.0	366.5	1176.5	532.0	247.5	411.0	<MDL	<MDL
Triclosan	120	3068.5	<MDL	<MDL	2422.0	<MDL	<MDL	<MDL	343.5	777.5	912.0

**Screening of Non-targeted Compounds**

The identification of non-targeted compounds uses accurate mass of the monoisotopic peak M and isotopic (M+1) peaks, relative intensities of the M/(M+1) peaks and isotopic pattern of the halogenated compounds. Manual inspection of line shape of the XIC chromatogram, major fragment ions from the mass spectrum will also improve the confidence and credibility of analytical results. Figure 4 shows examples of true positive identification of 3-phenoxybenzoic acid, a common primary metabolite of the synthetic pyrethroid insecticides (4A); a halogen containing xenobiotic 3,5-dibromo-4-hydroxybenzoic acid (4B); and an artificial sweetener sucralose (Splenda®) (4C).

Figure 5 shows an example of false-positive identification of desethylatrazine, an environmental metabolite of the pesticide atrazine. The mono-isotopic peak M has a mass error of 0.2454 ppm and the XIC has a perfect Gaussian shape and can be considered as a positive identification. However, mismatch of chlorine isotopic pattern concludes that the compound in question is not desethylatrazine.

FIGURE 4. Examples of true-positive identification.

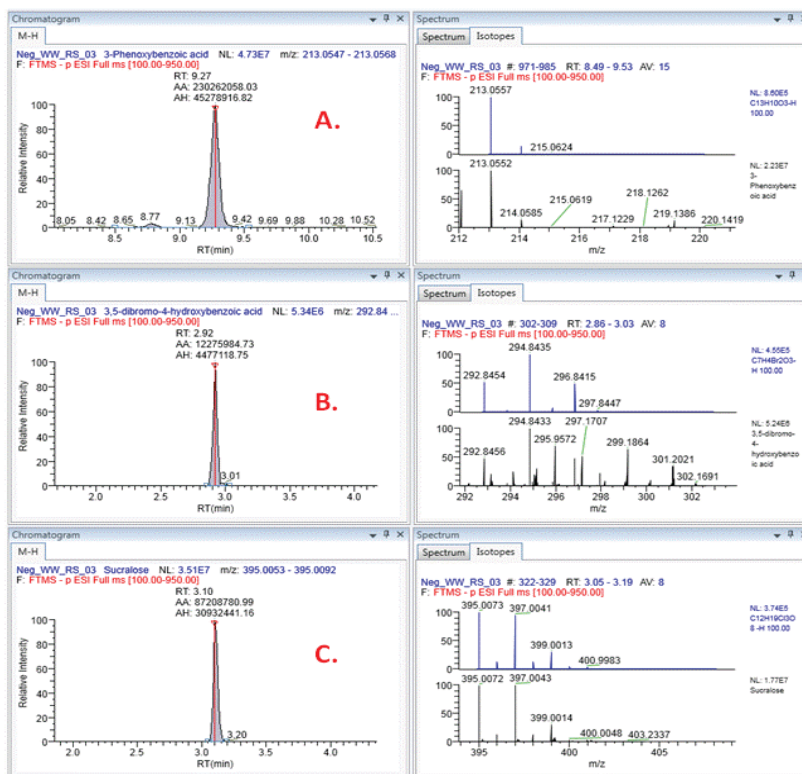

FIGURE 5. Example of a false-positive identification.

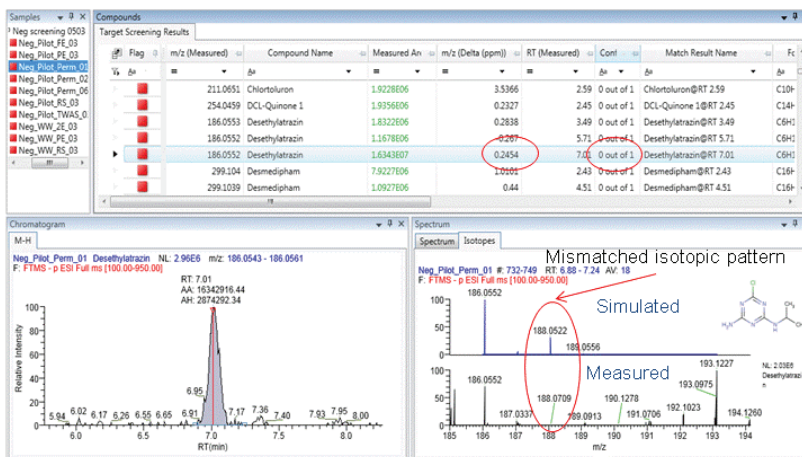

Table 2 lists screening results of non-targeted compounds found in these 10 WWTP samples along with their occurrence in both the positive and negative mode using the 312 CEC database. Of the 48 compounds in the top 10<sup>th</sup> percentile of area counts, bisphenol A was the only one positively identified.

**TABLE 2. Results of non-targeted compound analysis (Occu.: Occurrence; CBZ: Carbamazepine).**

Compound Name	Occu.	Compound Name	Occu.
Benzotriazol	100%	Isoproturon-didemethyl	80%
Methyl-Benzotriazol	100%	Primidon	80%
N,N-Didesvenlafaxin	100%	3-(4-Methylbenzylidene)-camphor	70%
N-Desvenlafaxine	100%	Valsartan	70%
O-Desvenlafaxine	100%	Acridone	60%
Tramadol	100%	Dimethachlor	60%
Venlafaxine	100%	2-(2-Hydroxy-5-methylphenyl)benzotriazole	50%
Lamotrigin	100%	2-Ethylhexyl-4-methoxycinnamate	50%
Metoprolol	100%	Clarithromycin	50%
Acridine	100%	Valsartan	80%
Dinoseb	100%	OH-Diclofenac	80%
n-Perfluorooctanoic acid	100%	2-(2,4-Dichlorophenoxy)-phenol	80%
Galaxolidone	100%	5-Chloro-2-(2-chlorophenoxy)-phenol	80%
Nonylphenol monoethoxylate	100%	5-Chloro-2-(4-chloro-2-hydroxyl-phenyl)phenol	80%
Perfluorooctane sulfonate	100%	5-Chloro-2-(4-chlorophenoxy)-phenol	80%
Carbamazepine-10,11-epoxide	100%	Irbesartan	70%
10,11-Epoxide-CBZ	100%	Bentazon	70%
OH-CBZ	100%	Ethofumesate	70%
Fenofibric-Acid	100%	Oxazepam	70%
3-Phenoxybenzoic acid	90%	Prometon	60%
Sucralose	90%	Terbumeton	60%
Nonylphenol diethoxylate	90%	Phenazon (Antipyrine)	60%
Di-OH-CBZ	90%	Primidon	60%
Perfluorohexane sulfonate	90%	Fluconazole	60%

## Conclusion

It is demonstrated that the combination Orbitrap MS hardware and TraceFinder software is a powerful tool in the analysis of contaminants of emerging concern, with improved data quality, confidence and credibility in analytical results. These include the lack of a analytical standards and hence, chromatographic retention time for the confirmation of non-targeted compounds dictated that caution must be taken to avoid the false-identification of CECs.

- True positive identification of targeted and tentative identification of non-targeted compounds including pharmaceutically active compounds, endocrine disrupting compounds and environmental metabolites;
- To achieve unambiguous identification of targeted and non-targeted analytes, a mass resolving power of 140,000 should always be used along with a 2.1x100 mm UHPLC column that produces chromatographic peak of full-width-at-half-maximum of 3–5 sec.
- Identification by accurate mass of M and isotopic (M+1) peaks and their relative intensity of M/(M+1) can achieve reliable results. Confirmation by fragment ion(s), as suggested by SANCO (Ref. 2), library search and complementary UHPLC information can be useful to improve the confidence and credibility of results.

## References

1. "The Determination of Emerging Organic Pollutants in Environmental Matrices by Liquid Chromatography-Tandem Mass Spectrometry (LC-MS/MS)", Ontario Ministry of the Environment method E3454. Available via [laboratoryservicesbranch@ontario.ca](mailto:laboratoryservicesbranch@ontario.ca).
2. "Method validation and quality control procedures for pesticide residues analysis in food and feed", Document N° SANCO/12495/2011.

## Acknowledgements

We would like to thank Dr. Vince Taguchi, Dr. Eric Reiner and Ms. Renee Luniewski for providing valuable suggestions to make this work possible.

[www.thermofisher.com](http://www.thermofisher.com)

©2016 Thermo Fisher Scientific Inc. All rights reserved. Splenda is a Registered trademark of McNeil Nutritionals, LLC. Microsoft and Excel are registered trademarks of Microsoft Corporation. Waters is a trademark of Waters Corporation. All other trademarks are the property of Thermo Fisher Scientific, Inc. and its subsidiaries. Specifications, terms and pricing are subject to change. Not all products are available in all countries. Please consult your local sales representative for details.

**Africa-Other** +27 11 570 1840  
**Australia** +61 3 9757 4300  
**Austria** +43 1 333 50 34 0  
**Belgium** +32 53 73 42 41  
**Canada** +1 800 530 8447  
**China** +86 10 8419 3588  
**Denmark** +45 70 23 62 60

**Europe-Other** +43 1 333 50 34 0  
**Finland/Norway/Sweden**  
+46 8 556 468 00  
**France** +33 1 60 92 48 00  
**Germany** +49 6103 408 1014  
**India** +91 22 6742 9434  
**Italy** +39 02 950 591

**Japan** +81 45 453 9100  
**Latin America** +1 561 688 8700  
**Middle East** +43 1 333 50 34 0  
**Netherlands** +31 76 579 55 55  
**New Zealand** +64 9 980 6700  
**Russia/CIS** +43 1 333 50 34 0  
**South Africa** +27 11 570 1840

**Spain** +34 914 845 965  
**Switzerland** +41 61 716 77 00  
**UK** +44 1442 233555  
**USA** +1 800 532 4752

**Thermo**  
SCIENTIFIC  
Part of Thermo Fisher Scientific





# Fully Automated, Trace-Level Determination of Parent and Alkylated PAHs in Environmental Waters by Online SPE-LC-APPI-MS/MS

Cesar E. Ramirez<sup>1</sup>, Chengtao Wang<sup>1</sup>, Piero R. Gardinali<sup>1</sup>, Jennifer Massi<sup>2</sup>, Jonathan Beck<sup>2</sup>

<sup>1</sup>Florida International University, Department of Chemistry and Biochemistry, North Miami Beach, FL

<sup>2</sup>Thermo Fisher Scientific, San Jose, CA

## Key Words

Online SPE, dopant-assisted APPI, seawater, reclaimed water, rainwater runoff, PAH, alkylated PAHs, EQUan, TSQ Quantum Access, mass spectrometry

## Goal

To develop a fast, fully automated protocol for determining a large number of parent PAHs and alkylated PAHs in environmental waters, using online solid-phase extraction coupled with liquid chromatography and tandem mass spectrometry.

## Introduction

Polycyclic aromatic hydrocarbons (PAHs) are persistent organic pollutants produced by both human activities and natural phenomena. PAHs enter surface waters mainly by atmospheric fallout, urban runoff, municipal and industrial effluents, and the spill or leakage of petroleum and its derivatives.<sup>1,2</sup> Petroleum-derived mixtures contain large amounts of PAHs<sup>3</sup> and these compounds are often used as markers to determine the source, fate, and potential effects on natural resources after such substances are released to the environment.<sup>4,5</sup> Many PAHs have been found to have toxic, carcinogenic, and mutagenic properties,<sup>6,7</sup> which have prompted the imposition of strict regulations on their releases in industrial and municipal effluents and their concentrations in environmental waters and drinking water supplies. Both the United States Environmental Protection Agency (US EPA) and the European Union have considered at least 16 parent PAHs as priority pollutants for environmental monitoring purposes.<sup>8</sup>

Well-established methodologies are available for the analysis of PAHs in waste and surface waters, usually involving liquid-liquid extraction (LLE) with n-hexane, toluene, benzene, methylene chloride, or cyclohexane,<sup>1</sup> followed by cleanup steps and detection by gas chromatography and mass spectrometry (GC-MS).<sup>9-12</sup> However, LLE requires a high volume of sample, is labor intensive, and time consuming, which severely limits sample throughput. In addition, large amounts of organic solvents are evaporated to concentrate the analytes. Release of the solvent vapor into the atmosphere causes environmental concerns.<sup>1,13,14</sup>

Solid-phase extraction (SPE) provides an alternative to LLE for sample preparation for PAH analysis. The well-established approach of injecting the sample into a large-volume sample loop connected between the SPE pump and the SPE column allows for sample handling by automated autosamplers.<sup>15-17</sup> In this application note, a fast, fully automated protocol for the determination of parent and alkylated PAHs in environmental waters is presented on the basis of work using online SPE coupled with liquid chromatography (LC) and tandem mass spectrometry (MS/MS) detection with the Thermo Scientific™ EQUan™ online SPE LC-MS system.<sup>18</sup> Optimized conditions for SPE extraction, carryover control, LC separation, and APPI-MS/MS detection are also presented. A comparison between the developed method and LLE-GC-MS in terms of chromatographic resolution and sensitivity was performed, and examples of environmental applications are shown.

## Experimental

### Materials and Reagents

Certified PAH and isotopically labeled PAH standard mixtures, along with additional single PAH standards, were used.<sup>18</sup> Standard reference materials (SRM 2260a and SRM 1491a) were obtained from NIST (Gaithersburg, MD). Stock solutions were stored at  $-20\text{ }^{\circ}\text{C}$  until needed. Chlorobenzene dopant (extra dry, 99.8% pure) is available from Thermo Fisher Scientific. Artificial seawater (3.5% w/v) was prepared using the commercially available Instant Ocean<sup>®</sup> salt. Chromatographic studies were performed using Fisher Chemical<sup>™</sup> Optima<sup>™</sup> LC/MS-grade acetonitrile, methanol, and water.

### Sample Collection

All glassware used to collect and store samples was cleaned by heating to  $450\text{ }^{\circ}\text{C}$  for at least 6 h before use. Field samples were collected using 60 mL amber glass vials rinsed once with surface water, filled, and capped with PTFE-lined plastic caps being careful to eliminate trapped air. Vials were then placed in plastic bags and transported on ice to the laboratory. A sampling blank, consisting of a 60 mL vial filled with artificial seawater, was placed on ice and transported during sampling. Seawater samples were collected in a single trip during August 2012 around Northern Biscayne Bay, adjacent to the metropolitan area of Miami, Florida. Two reclaimed water samples were collected from the North District Wastewater Treatment Plant in the Miami-Dade County during August and September 2012.

Rainwater runoff samples were collected during a heavy rain event in June 2013 from drainage openings in two parking lots at the Florida International University (FIU) Biscayne Bay campus and at the parking lot of a nearby residential complex. A reference rainwater sample was collected during the same event using a 1 L amber glass bottle and a glass funnel. All samples were stored at  $4\text{ }^{\circ}\text{C}$ . Seawater samples were analyzed no more than 14 days after collection. Rainwater, rainwater runoff, and reclaimed waters were analyzed within 24 h of collection.

### Sample Preparation

#### Environmental water

Working solutions of all PAHs were prepared each analysis day in methanol from stock solutions or certified standards. Refrigerated samples were allowed to reach room temperature before preparation. Vials were vigorously shaken for at least 20 s. Then 10 mL aliquots of raw water samples were transferred using disposable glass graduated pipettes directly from the sampling containers into 10 mL LC vials containing 0.55 mL of a methanol solution of isotopically labeled PAHs and 0.45 mL of water. The resulting solutions contained 5% methanol and 95% water with 100 ng/L of each isotopically labeled PAH. Solutions were capped, thoroughly mixed, and loaded into the online SPE system without further treatment.

### Calibration solutions

Matrix-matched calibration solutions (5–500 ng/L) were prepared using the same procedure, using artificial seawater and working solutions containing analytes and internal standards in methanol. A seven-point set of calibration solutions was freshly prepared for each analysis batch.

### Liquid Chromatography

Online preconcentration was performed using an EQUAN online SPE system consisting of an HTC-PAL<sup>™</sup> autosampler system (CTC Analytics, Zwingen, Switzerland) equipped with a 5 mL glass syringe, a Thermo Scientific<sup>™</sup> Accela<sup>™</sup> 1000 LC pump as an analytical HPLC pump, and an Accela 600 LC pump as an SPE loading pump. The online SPE column was a Thermo Scientific<sup>™</sup> Hypersil GOLD aQ<sup>™</sup> column ( $20 \times 2.1\text{ mm}$ ,  $12\text{ }\mu\text{m}$  particle size). Analytical separations were carried out using a Hypersil Green PAH column ( $150 \times 2.1\text{ mm}$ ,  $3\text{ }\mu\text{m}$  particle size), protected by a Hypersil Green PAH guard column ( $10 \times 2.1\text{ mm}$ ,  $3\text{ }\mu\text{m}$  particle size). Stainless steel tubing was used throughout the SPE-LC-MS/MS system. Dopant to assist photo-ionization was delivered using the combined output of two programmable syringe pumps.

The samples, quality controls, and calibration solutions were loaded onto the 10 mL stainless steel loop (rotary valve A, Figure 1). The SPE column was placed in a second rotary valve (valve B, Figure 1), allowing connection with either the loading pump or the analytical pump. Analysis steps, determined by valve turning events, are graphically presented in Figure 1. Ten milliliters of sample were passed through the SPE column within 5 min, followed by 2 mL of 1% methanol in water to remove inorganic species. Then, 0.5 mL of a short gradient to 60% methanol and 0.5 mL of 60% methanol were passed to prepare the SPE column for connection with the organic-rich analytical stream (Step 1). The SPE column was connected to the analytical column and gradient separation was started, while the sample loop was completely filled with methanol from the SPE LC pump (Step 2). At 15 min, valve A turned and the methanol-filled sample loop was connected with the injection port. The autosampler sequentially injected 5 mL of methanol, 5 mL of water, and two 5 mL portions of the next sample in the queue while the chromatographic separation continued (Step 3). Finally, at 24 min, valve B turned again (Step 4) and connected the SPE LC pump to the SPE column, which was then cleaned with 1 mL of acetonitrile and progressively taken to the highly aqueous initial conditions. These steps added to a total run time of 28 min per sample.

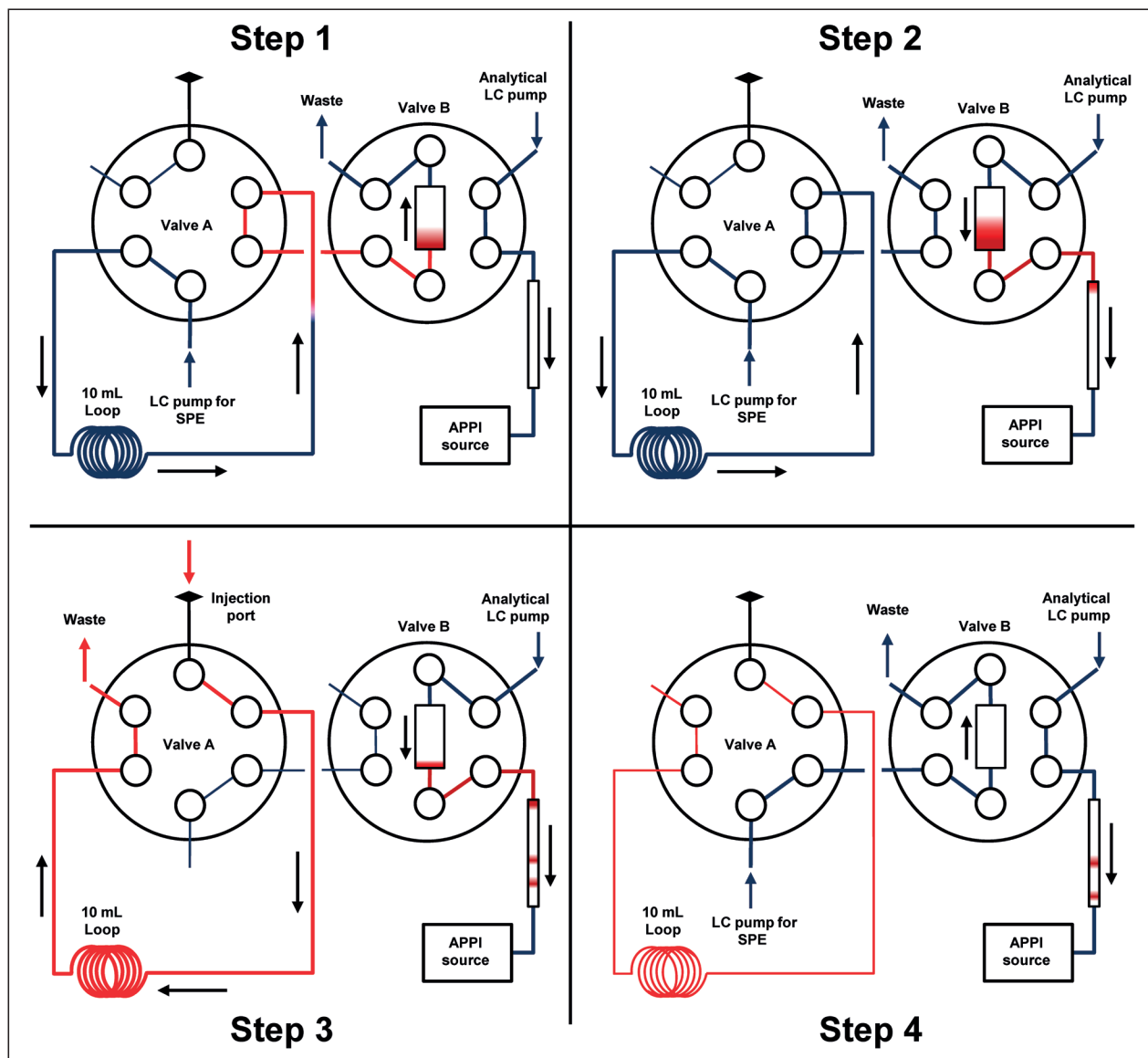

Figure 1. Online SPE system and automated analysis steps. Active flows are shown by arrows and thicker lines. Red: sample and PAHs; blue: mobile phases

### Mass Spectrometry

Detection of analytes was performed on a Thermo Scientific™ TSQ Quantum Access™ triple-stage quadrupole mass spectrometer equipped with a Thermo Scientific™ Ion Max™ API source with an APPI probe.

Hydrocarbons (PAHs) are difficult to ionize by conventional LC/MS techniques and yield poor response. Using a dopant-assisted atmospheric pressure photoionization (APPI) interface, an intermediary compound was introduced at high concentrations into the APPI source. This produced large numbers of ions, which in turn underwent a kinetically favored charge transfer with the eluting analytes, provided substantial sensitivity gain relative to dopant-free photoionization.

The following parameters were used for all analytes:

Ion mode	Positive
Skimmer offset	-10 V
Sheath gas (N <sub>2</sub> )	40 arbitrary units
Auxiliary gas (N <sub>2</sub> )	20 arbitrary units
Capillary temperature	250 °C
Vaporizer temperature	250 °C
Collision gas (Ar) pressure	2.1 mTorr
Scan time	0.020 s
Scan width	0.020 <i>m/z</i>

To reduce unnecessary instrument scans, two detection segments were used (segment 1, 8–18 min, and segment 2, 18–28 min). Chlorobenzene dopant was introduced to the APPI source only during the detection period (8–28 min) through the nitrogen auxiliary gas line, delivered by two programmable syringe pumps operating simultaneously for total flow rate of 10% of that of the column eluent. Selected-reaction monitoring (SRM) scan events were obtained by direct infusion of individual PAH solutions and are listed in Table 1.

Table 1. Summary of PAH compounds and their SRM scan events for PAHs tested with this method (bold: 16 US EPA priority PAHs, italic: labeled PAH internal standards)

PAH	CAS Number	M <sup>+</sup> Ion (m/z)	Quant. Product (m/z)	CE (V)	Confirm. Product (m/z)	CE (V)	Confirm. Product Int. (%) <sup>a</sup>	Tube Lens (V)	RT (min)	Scan Seg. <sup>b</sup>
<b>Acenaphthene</b>	83-32-9	154	153	16	152	29	72	82	13.1	1
<i>Acenaphthene-D10</i>	15067-26-2	164	162	23	160	35	70	72	12.9	1
<b>Acenaphthylene</b>	208-96-8	152	151	16	150	23	50	69	12.1	1
Anthanthrene	191-26-4	276	274	43	272	69	99	108	24.2	2
<b>Anthracene</b>	120-12-7	178	176	29	152	22	54	82	14.9	1
<b>Benz[a]anthracene</b>	56-55-3	228	226	35	225	52	22	92	17.6	1+2
Benzo[a]fluoranthene	203-33-8	252	250	73	248	41	38	120	18.5	1+2
<b>Benzo[a]pyrene</b>	50-32-8	252	250	73	248	41	42	120	20.3	1+2
<i>Benzo[a]pyrene-D12</i>	63466-71-7	264	260	51	236	47	15	82	20.0	2
<b>Benzo[b]fluoranthene, perylene<sup>c</sup></b>	205-99-2, 198-55-0	252	250	73	248	41	38	120	19.1	1+2
Benzo[b]fluorene	243-17-4	216	215	14	213	38	50	53	17.4	1+2
Benzo[c]phenanthrene	195-19-7	228	226	35	225	52	24	92	16.3	1+2
Benzo[e]pyrene, benzo[j]fluoranthene <sup>c</sup>	192-97-2, 205-82-3	252	250	73	248	41	37	120	18.8	1+2
<b>Benzo[g,h,i]perylene</b>	191-24-2	276	274	43	272	69	60	108	22.0	2
<b>Benzo[k]fluoranthene</b>	207-08-9	252	250	73	248	41	35	120	19.9	1+2
Biphenyl	92-52-4	154	152	29	153	16	90	82	12.4	1
C1-chrysenes	-	242	239	42	241	22	65	80	18-20	1+2
C1-dibenzothiophenes	-	198	197	10	165	25	49	68	14-16	1+2
C1-fluoranthenes/pyrenes	-	216	215	14	213	38	50	53	15-17	1+2
C1-fluorenes	-	180	165	19	164	35	21	53	14-16	1
C1-naphthalenes	-	142	141	21	115	32	71	57	12.5	1
C1-phenanthrenes/anthracenes	-	192	191	22	189	40	90	67	15-18	1+2
C2-dibenzothiophenes	-	212	211	20	152	39	30	83	15-19	1+2
C2-naphthalenes	-	156	141	19	115	33	60	55	13-15	1
C2-phenanthrenes/anthracenes	-	206	189	39	191	22	58	137	17-19	1+2
C3-naphthalenes	-	170	155	18	153	30	34	75	14-16	1
C4-phenanthrenes/anthracenes	-	234	219	11	204	22	75	10	17-19	1+2
Carbazole	86-74-8	167	166	40	165	40	13	80	10.9	1
<b>Chrysene</b>	218-01-9	228	226	35	225	52	22	92	18.0	1+2
<i>Chrysene-D12</i>	1719-03-5	240	236	37	212	34	14	108	17.8	1+2
<b>Dibenz[a,h]anthracene</b>	53-70-3	278	276	42	274	65	62	105	21.9	2
Dibenzothiophene	132-65-0	184	152	30	139	39	90	85	14.0	1
<b>Fluoranthene</b>	206-44-0	202	200	40	199	57	16	73	15.6	1
<b>Fluorene</b>	86-73-7	166	165	21	164	33	23	101	13.6	1
<i>Fluorene-D10</i>	81103-79-9	176	174	28	172	38	21	65	13.5	1
<b>Indeno[1,2,3-cd]pyrene</b>	193-39-5	276	274	43	272	69	48	108	22.7	2
<b>Naphthalene</b>	91-20-3	128	127	25	102	20	90	48	11.5	1
<i>Naphthalene-D8</i>	1146-65-2	136	134	30	108	30	59	80	11.4	1
Naphthobenzothiophene	239-35-0	234	202	25	189	33	90	100	18.2	1+2
<i>Perylene-D12</i>	1520-96-3	264	260	51	236	47	9	82	18.9	2
<b>Phenanthrene</b>	85-01-8	178	176	29	152	22	75	82	14.2	1
<i>Phenanthrene-D10</i>	1517-22-2	188	184	40	160	32	98	82	14.0	1
<b>Pyrene</b>	129-00-0	202	200	40	199	57	20	73	16.0	1
Triphenylene	217-59-4	228	226	35	225	52	23	92	16.8	1+2

<sup>a</sup>Relative to quantification product ion. <sup>b</sup>Segment 1: 8-18 min, segment 2: 18-28 min. <sup>c</sup>Coelutions observed in Standard Reference Material 2260a.

## Data Analysis

Data analysis was performed using Thermo Scientific™ TraceFinder™ EFS software version 3.0.

## Results and Discussion

### Optimization of Dopant-Assisted APPI Detection

Pure chlorobenzene provides efficient charge transfer ionization for all PAH in the presence of water, methanol, and acetonitrile.<sup>19</sup> Therefore, commercially available high-purity chlorobenzene was used as dopant in this study without any treatment. Under these conditions, a strong positive molecular ion ( $M^+$ ) for each analyte was always observed and isolated as the precursor ion for the SRM scan events, which is consistent with observations by other authors who have used chlorobenzene as dopant for APPI-LC-MS analysis of PAHs.<sup>20</sup>

Two programmable syringe pumps and a spraying device placed in the auxiliary nitrogen gas stream were used. With this system, little or no backpressure was applied to the syringe pumps, which translated into stable dopant delivery. Since analytical signals maximized at a dopant flow rate of approximately 10% of the eluent flow rate, using a programmable dopant system has the advantage of maintaining this optimum ratio as the eluent flow rate changes during the chromatographic separation.

The spraying system was tested with two syringe pumps equipped with four 10 mL syringes (40 mL total), which provided 26 runs (approximately 12 h of continuous operation) before syringe refills were required. This translates into a consumption of about 1.5 mL of chlorobenzene per sample. In comparison, the traditional LLE-GC-MS approach may require up to 150 mL ( $3 \times 50$  mL extractions) with organic solvents, such as methylene chloride, to ensure a high recovery. Chlorobenzene has a much shorter atmospheric persistence (half-life of 20–40 h) than methylene chloride and is not considered a carcinogen. Thus, both the lower quantity and the nature of the halogenated waste produced suggest that the online SPE-LC-APPI-MS/MS is a more environmentally friendly methodology than LLE-GC-MS.

### Optimization of Chromatographic Separation

During compound optimization for SRM detection, it was observed that PAHs with the same parent masses have similar behavior upon collision-induced dissociation (same product ions, same collision energy, see Table 1), eliminating the possibility of selective detection of isobaric PAHs. Because comprehensive PAH analysis requires quantitation beyond the 16 priority PAHs, a carefully controlled LC separation is required to solve most of these isobaric interferences. In addition, since PAH molecules have fixed planar conformations, chromatographic selectivity is governed solely by their molecular dimensions.<sup>21</sup>

Furthermore, complete chromatographic resolution of the 16 PAHs listed as priority by the EPA using the Hypersil Green PAH stationary phase has been previously reported.<sup>22,23</sup> This stationary phase was selected to explore the possibility of a liquid chromatography separation of most alkylated PAHs as these compounds are often used as markers to identify pollution sources and environmental transformations.<sup>4,24</sup> Light PAHs

(i.e., alkylnaphthalenes) could be only efficiently separated using a methanol/water gradient system, as the use of acetonitrile/water caused fast elution with no resolution control. On the other hand, methanol proved to be a weak solvent for PAHs  $m/z$  228 and above, causing excessively high retention times and peak shape broadening even at 100% methanol isocratic elution. A second gradient between methanol and acetonitrile was then used after the water/methanol system. Still, retention times for PAHs  $m/z$  252 and above were also very high even at 100% acetonitrile conditions. To perform an efficient, wide mass range separation, a flow rate gradient was also used in combination with solvent strength control, taking advantage of the steep backpressure drop observed as water is removed from the analytical column during the gradient.

Figure 2 compares the obtained resolution of alkylated PAHs contained in the Standard Reference Material 1491a to that obtained by traditional GC-MS analysis. Although resolution for C1-naphthalenes was lower than GC, two marginally resolved peaks are observed in the SPE-LC-MS/MS separation of these compounds that differ only in the position of a single methyl group between adjacent carbon atoms. Since C1-naphthalenes are detected as a group, the limited resolution does not affect quantitation. As analyte mass increased, the observed resolution behavior tended to be similar to that obtained by GC-MS. Both techniques had the same difficulty in separating C1-fluoranthenes and C1-pyrenes (four peaks should be observed in the  $m/z$  216 chromatogram), while complete resolution was observed for 3-methylchrysene and 6-methylchrysene in both methods. All four methylphenanthrenes are visible and well separated from the 2-methylanthracene signal, in contrast to the GC-MS separation where a coelution of the two groups is observed. These results indicate that isobaric-alkylated PAHs can be partially resolved using single-column liquid chromatography.

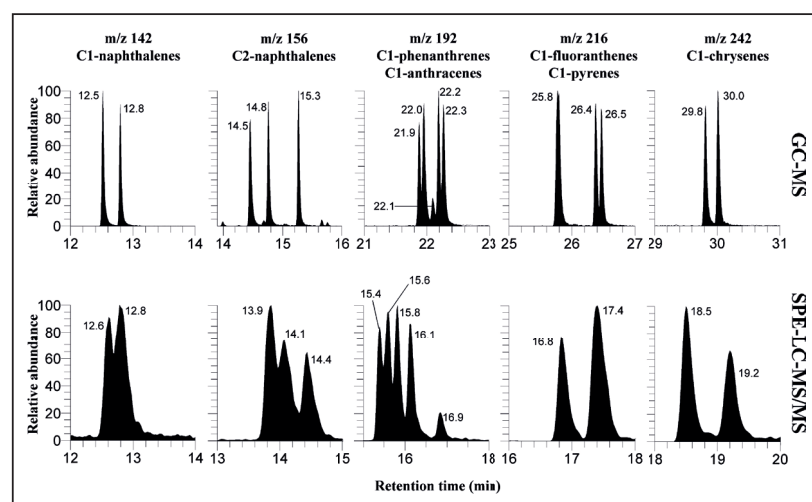

Figure 2. Comparison of peaks of PAHs contained in the Standard Reference Material 1491a, obtained by GC-MS analysis (1/10 dilution in hexane, top) and by SPE-LC-MS/MS analysis (1/27,500 serial dilution in seawater, bottom). Reference material listed compounds: C1-naphthalenes (1-methyl, 2-methyl); C2-naphthalenes (1,2-dimethyl, 1,6-dimethyl, 2,6-dimethyl); C1-phenanthrenes (1-methyl, 2-methyl, 3-methyl, 9-methyl); C1-anthracenes (2-methyl); C1-fluoranthenes (1-methyl, 3-methyl); C1-pyrenes (1-methyl, 4-methyl); C1-chrysenes (3-methyl, 6-methyl). Standard Reference Material 1491a also contains one C2-phenanthrene (1,7-dimethyl, not shown)



Although the observed resolution of alkylated PAHs may not be enough to replace capillary GC-MS for PAH fingerprinting applications, the resolution obtained by SPE-LC-MS/MS could be enough to be used as a screening tool to decide if a given sample should be analyzed using those time-consuming techniques, taking advantage of the low sample consumption and the speed of this methodology. Additionally, the absence of sample preparation could provide the ability to track in almost real time the extent of a contamination by monitoring for the alkylated PAH-specific concentration patterns observed at the pollution source. With the gradient separation used, baseline resolution of the 16 priority PAHs from their isobaric interferences present in Standard Reference Material 2260a was obtained except for benzo[*b*]fluoranthene, which coeluted with perylene. Attempts to separate these compounds without a significant increase in run time were unsuccessful, and since method speed was a priority, these compounds were quantified as a group.

#### **Optimization of the Online SPE Procedure**

SPE column loading, washing, and reconditioning parameters were optimized for extraction recovery, seawater salt elimination, and prevention of carryover using isotopically labeled PAHs as testing compounds. Same-day 10 mL injections of 100 ng/L (online SPE) and 100  $\mu$ L direct injections of 10,000 ng/L solutions in 70% methanol/water were made, accounting for 1.0 ng on column for each compound (the 5 mL injection mode was tested against 50  $\mu$ L direct-injection, 0.5 ng on column). Percent recoveries were obtained using averaged peak areas, using at least three direct-injection runs and two online SPE runs. The direct-injection method had the same analytical gradient as the online SPE method. The observed retention times were in agreement with an 8 min offset due to the online SPE time, ensuring similar APPI source conditions at elution in both injection modes thus enabling the direct comparison of peak areas. Passing at least 2 mL of aqueous mobile phase through the loading column after the SPE step was enough to prevent the transfer of salt residues to the APPI source.

#### **Method Validation**

##### **Calibration and quality control**

Calibration curves were obtained by plotting the peak area ratio of each PAH to an isotopically labeled PAH internal standard against concentration in nanograms per liter. Linearity was observed for all analytes in the range used ( $R^2 > 0.99$ ; 5 to 500 ng/L). Calibration stability was evaluated every 10 runs by injecting seawater fortified at 100 ng/L. Calibration and method accuracy was verified by injecting artificial seawater fortified with serially

diluted standard reference materials 1491a and 2260a. With every analysis batch, a negative (reagent and sampling) and a positive (fortified at 100 ng/L) blank were also used. Additionally, one sample duplicate and one fortified matrix experiment were always analyzed per every five samples. The system was continuously tested for carryover by injecting a reagent blank after the highest calibration standard and after every calibration verification standard. Compound identification was considered positive when signals with a S/N ratio above 3 were present in both the quantification and confirmation SRM transitions, with a maximum retention time difference of 0.2 min relative to calibration standards or standard reference materials. Calculated concentrations below method detection limits (MDLs) were considered non-detections. A reporting limit (RL) of three times the MDLs was set in order to reduce the risk of false positives and ensure data quality.

##### **Determination of method detection limits**

MDLs were calculated by multiplying the standard deviation from seven measurements by the Student *t* value ( $t_{(7-1, 99)} = 3.143$ ), according to procedures outlined by the US EPA,<sup>9</sup> using natural seawater (from FIU Campus Beach, see Table 2), fortified at 50 ng/L. For sensitivity comparison, MDLs for the traditional LLE+GC-MS methodology were determined using 1,000 mL of the same seawater sample also fortified to 50 ng/L and extracted three times with 50 mL portions of methylene chloride. The extract was obtained, evaporated, and cleaned according to established methods (EPA 3510C and 3630C)<sup>10,11</sup> and analyzed by a GC-MS method available elsewhere.<sup>12</sup> The average MDLs corrected for sample size obtained by LLE-GC-MS analysis are an order of magnitude higher than those obtained by SPE-LC-MS/MS.<sup>18</sup> Although in practice lower MDL values can be obtained with LLE due to the possibility of using larger sample volumes, the higher per volume sensitivity of the online SPE approach is more useful when limited amounts of sample are available. Also, the low sample volume required and high sample throughput of this method facilitate the analysis of multiple quality controls such as duplicates and fortified matrix experiments.

Table 2. Method performance upon analysis of surface seawater of US EPA priority PAHs.

Location			Haulover Boat Ramp	Haulover Marina	Dinner Key Marina			Bayfront Park	Pelican Harbor Park	FIU Campus Beach	Miami Beach Marina			
Latitude N			25.91684	25.90613	25.7272			25.77274	25.84713	25.90994	25.77194			
Longitude W			80.12383	80.12396	80.23767			80.18491	80.16782	80.1364	80.14027			
PAH	MDL (ng/L)	RL (ng/L)	Measured Conc (ng/L)	Measured Conc (ng/L)	Measured Conc (ng/L)	Duplicate (ng/L)	Ave $\pm\sigma$ (ng/L)	Measured Conc (ng/L)	Measured Conc (ng/L)	Measured Conc (ng/L)	Measured Conc (ng/L)	Measured Conc in Fortified Matrix Experiment (ng/L)	Fortification Level (ng/L)	% Rec
Acenaphthene	15	45	-	-	-	-		-	-	-	-	184	176	104
Acenaphthylene	16	49	-	-	-	-		-	-	-	-	179	176	102
Anthracene	29	86	-	-	-	-		-	-	-	-	179	176	101
Benz[a]anthracene	12	36	-	-	-	-		-	-	-	-	160	176	91
Benzo[b]fluoranthene, perylene	34	102	-	-	-	-		-	-	-	-	370	373	99
Benzo[g,h,i]perylene	19	57	-	-	-	-		-	-	-	-	185	176	105
Benzo[k]fluoranthene	21	63	-	-	-	-		-	-	-	-	189	176	108
Crysenes	11	33	-	-	-	-		-	-	-	-	173	176	98
Dibenz[a,h]anthracene	16	48	-	-	-	-		-	-	-	-	188	176	107
Fluoranthene	12	36	-	-	-	-		-	-	-	-	180	176	101
Fluorene	7.9	24	-	-	-	-		-	-	-	-	187	176	106
Indeno[1,2,3-cd]pyrene	26	78	-	-	-	-		-	-	-	-	197	176	112
Naphthalene	20	60	101	-	104	100	102 $\pm$ 2	-	-	-	-	189	176	107
C1-naphthalenes	13	40	129	-	74	76	75 $\pm$ 1	-	-	-	-	419	353	119
C2-naphthalenes	15	44	<RL	-	47	45	46 $\pm$ 1	-	-	-	-	177	176	101
Phenanthrene	19	57	-	-	-	-		-	-	-	-	167	176	94
Pyrene	17	50	-	-	-	-		-	-	-	-	166	176	94
<b>Total PAH</b>			230	0	225	221	<b>223<math>\pm</math>2</b>	0	0	0	0			
<b>% Recovery Average</b>														<b>103<math>\pm</math>7</b>

- Below MDL



### Examples of Environmental Applications

The developed methodology was tested by analyzing a group of multi-origin environmentally relevant water samples. Seawater collections were made from seven sites in northern Biscayne Bay. Naphthalene and alkylnaphthalenes were detected in two of the sites in which activity of small vessels was observed (Table 2). The elevated water solubility of naphthalenes relative to other PAHs<sup>1</sup> may increase their permanence in the water long enough to be detected by the grab sampling performed. Although the method sensitivity was not enough to detect background concentrations in samples where no active boating was observed, a capability of fast detection of focalized emission of petroleum-derived products was demonstrated.

Suspended particles in rainwater runoff resulting from the erosion of impervious surfaces have been documented as an important source of PAHs in the environment.<sup>25,26</sup> To assess the performance of the developed methodology

for this type of monitoring, rainwater and runoff samples from the drainage openings at three parking lots were collected during a heavy rain event in June 2013. As can be seen in Table 3, PAHs were detected in runoff from only the partially flooded parking lot located in a residential complex. Chromatograms for the priority PAHs detected in that sample are compared with reference rainwater in Figure 3, showing that interference-free detection and positive identification were obtained for these analytes except for benzo[*b*]fluoranthene, which is not resolved from perylene by this methodology as discussed before. Also, since no PAHs were observed in the reference rainwater, this data strongly suggests that the parking lot was the source of the contamination. The high number of parent PAHs detected, the predominance of heavy PAHs such as fluoranthene and pyrene, and their relative concentrations are in agreement with previous reports of PAHs in rainwater runoff from coated parking lots,<sup>27</sup> suggesting that the presented methodology is applicable for this type of study.

Table 3. Method performance upon analysis of rainwater and rainwater runoff of US EPA priority PAHs.

Sample Source		Direct Collection		Apartment Complex			FIU Biscayne Bay Campus				
Sample Description		Reference Rainwater		Partially Flooded Parking Lot			Parking Lot A	Parking Lot B			
PAH	MDL (ng/L)	RL (ng/L)	Measured Conc (ng/L)	Measured Conc (ng/L)	Duplicate (ng/L)	Ave $\pm\sigma$ (ng/L)	Measured Conc (ng/L)	Measured Conc (ng/L)	Measured Conc in Fortified Matrix Experiment (ng/L)	Fortification Level (ng/L)	% Rec
Acenaphthene	15	45	-	-	-		-	-	105	110	95
Acenaphthylene	16	49	-	-	-		-	-	119	110	109
Antracene	29	86	-	-	-		-	-	118	110	107
Benz[ <i>a</i> ]anthracene	12	36	-	190	202	196 $\pm$ 6	-	-	105	110	96
Benzo[ <i>b</i> ]fluoranthene, perylene	34	102	-	112	108	110 $\pm$ 2	-	-	216	220	98
Benzo[ <i>g,h,i</i> ]perylene	19	57	-	60	61	60.4 $\pm$ 0.7	-	-	124	110	113
Benzo[ <i>k</i> ]fluoranthene	21	63	-	<RL	<RL		-	-	105	110	96
Crysene	11	33	-	153	169	161 $\pm$ 8	-	-	112	110	101
Dibenz[ <i>a,h</i> ]anthracene	16	48	-	-	-		-	-	137	110	124
Fluoranthene	12	36	-	410	387	399 $\pm$ 12	-	-	104	110	95
Fluorene	7.9	24	-	<RL	<RL		-	-	100	110	91
Indeno[1,2,3- <i>cd</i> ]pyrene	26	78	-	<RL	<RL		-	-	130	110	118
Naphthalene	20	60	-	-	-		-	-	91	110	83
C1-naphthalenes	13	40	-	-	-		-	-	209	220	95
C2-naphthalenes	15	44	-	-	-		-	-	111	110	101
Phenanthrene	19	57	-	183	186	184 $\pm$ 1	-	-	116	110	105
Pyrene	17	50	-	293	315	304 $\pm$ 11	-	-	117	110	107
<b>Total PAH</b>			0	1401	1428	<b>1415<math>\pm</math>14</b>	0	0			
<b>% Recovery Average</b>											<b>102<math>\pm</math>10</b>

- Below MDL, <RL Detection below reporting limit (RL=3 $\times$ MDL)

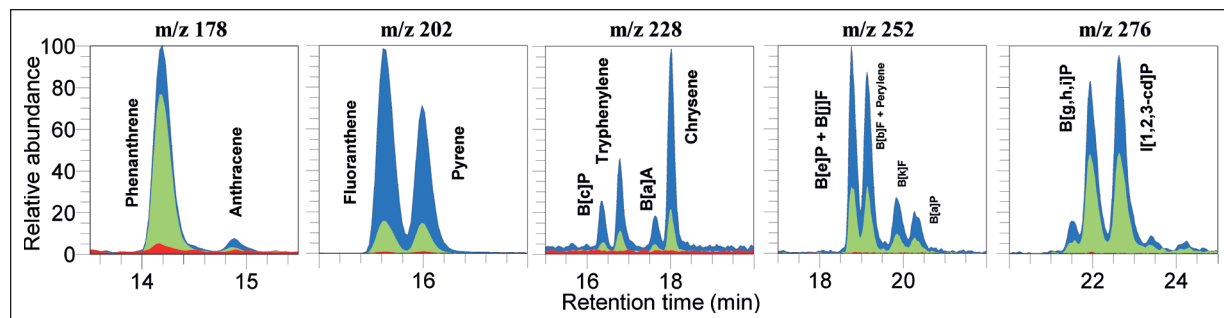

Figure 3. Chromatograms obtained upon analysis of a rainwater runoff sample from a residential parking lot and its comparison with reference rainwater. (Blue trace: main (quantitative) SRM transition in runoff sample; green trace: secondary (confirmation) SRM transition in runoff sample; red trace: main SRM transition from injection of reference rainwater)

Although not enough data is available to explain the non-occurrence of PAHs in runoff from the campus parking lots, the residential parking lot had a much slower drainage capability, and thus, the sample was collected under moderate flooding conditions. The lower drainage rate may have enhanced the possibility of detections as PAH-containing suspended particles could not be washed out by the rain as fast as in the campus parking lots. It is also possible that the nature of the coatings is different, as it has been shown that asphalt-based coatings contain many fewer PAHs than coal-based coatings.<sup>25</sup>

Samples of reclaimed water used for irrigation at FIU Biscayne Bay campus were collected in two different dates and analyzed in order to assess the performance of the developed methodology to detect PAHs discharged with WWTP effluents. Alkyl naphthalenes were detected in one of the samples (Table 4), but concentrations were lower than the reporting limit. Good recoveries were obtained in the fortified matrix experiment for reclaimed water, suggesting that method sensitivity rather than a severe matrix effect prevented positive quantification in these samples. Excellent recoveries were also obtained in fortified matrix experiments with the other two types of environmental waters tested with this method, which may suggest that the use of a wide range of molecular sizes of isotopically labeled PAHs normalizes analyte behavior during the automated preconcentration and analysis, keeping matrix effects under control in spite of the lack of any other sample preparation steps such as filtration. In addition, method reproducibility was also good upon analysis of duplicates of PAH-containing seawater and runoff samples.

Table 4. Method performance upon analysis of reclaimed water obtained from the Miami-Dade North District Wastewater Treatment Plant for US EPA priority PAHs.

PAH	MDL (ng/L)	RL (ng/L)	Measured Conc (ng/L)	Measured Conc (ng/L)	Measured Conc in Fortified Matrix Experiment (ng/L)	Fortification Level (ng/L)	% Recovery
Acenaphthene	15	45	-	-	203	176	115
Acenaphthylene	16	49	-	-	162	176	92
Anthracene	29	86	-	-	185	176	105
Benz[ <i>a</i> ]anthracene	12	36	-	-	164	176	117
Benzo[ <i>b</i> ]fluoranthene, perylene	34	102	-	-	363	373	97
Benzo[ <i>g,h,i</i> ]perylene	19	57	-	-	150	176	85
Benzo[ <i>k</i> ]fluoranthene	21	63	-	-	219	176	124
Crysene	11	33	-	-	210	176	119
Dibenz[ <i>a,h</i> ]anthracene	16	48	-	-	156	176	88
Fluoranthene	12	36	-	-	209	176	116
Fluorene	7.9	24	-	-	168	176	95
Indeno[1,2,3- <i>cd</i> ]pyrene	26	78	-	-	174	176	99
Naphthalene	20	60	-	-	161	176	91
C1-naphthalenes	13	40	-	-	364	353	103
C2-naphthalenes	15	44	-	<RL	228	176	118
Phenanthrene	19	57	-	-	175	176	99
Pyrene	17	50	-	-	200	176	111
<b>Total PAH</b>			0	0			
<b>% Recovery Average</b>							<b>104±12</b>

## Conclusion

An automated protocol for the comprehensive analysis of 28 parent PAHs and their extended alkylated homologues by online SPE-LC-MS/MS was successfully developed with optimized parameters for extraction, separation, and detection using dopant-assisted APPI. Method performance and the control of matrix effects were demonstrated by obtaining good recoveries upon analysis of seawater, reclaimed water, and rainwater runoff fortified with certified standards, showing the utility of this method to survey the occurrence of PAHs in waters at the urban environment. A survey of PAH concentration in a seawater environment influenced by a large urban area was conducted, and although background concentrations were below MDLs, localized PAH input events from boating activities were detected above reporting limits. With lower run times, very simple sample preparation, lower generation of toxic solvent waste, and higher sensitivity per volume of sample used, this method could represent a viable alternative to LLE-GC-MS for routine PAH monitoring, providing laboratories with a much higher sample throughput while reducing overall operation costs and the environmental impact of PAH analysis.

## References

1. Manoli, E.; Samara, C. Polycyclic aromatic hydrocarbons in natural waters: sources, occurrence and analysis. *Trac-Trends Anal Chem*, **1999**, *18*, 417–428.
2. Wolska, L.; Mechliniska, A.; Rogowska, J.; Namiesnik, J. Sources and fate of PAHs and PCBs in the marine environment. *Crit Rev Environ Sci Technol*, **2012**, *42*, 1172–1189.
3. Wang, Z.D.; Stout, S.A.; Fingas, M. Forensic fingerprinting of biomarkers for oil spill characterization and source identification. *Environ Forensic*, **2006**, *7*:105–146.
4. Boehm, P.D.; Douglas, G.S.; Burns, W.A.; Mankiewicz, P.J.; Page, D.S.; Bence, A.E. Application of petroleum hydrocarbon chemical fingerprinting and allocation techniques after the Exxon Valdez oil spill. *Mar Pollut Bull*, **1997**, *34*, 599–613.
5. Boehm, P.D.; Neff, J.M.; Page, D.S. Assessment of polycyclic aromatic hydrocarbon exposure in the waters of Prince William Sound after the Exxon Valdez oil spill: 1989–2005. *Mar Pollut Bull*, **2007**, *54*, 339–356.
6. Agency for Toxic Substances and Disease Registry (ATSDR) (1995) Toxicological profile for polycyclic aromatic hydrocarbons (PAHs). U.S. Department of Health and Human Services, Atlanta.
7. Manzetti, S. Ecotoxicity of polycyclic aromatic hydrocarbons, aromatic amines, and nitroarenes through molecular properties. *Environ Chem Lett*, **2012**, *10*, 349–361.
8. Lerda, D. Polycyclic aromatic hydrocarbons (PAHs) factsheet. European Commission, Joint Research Centre, Institute for Reference Materials and Measurements, 2012, Belgium.
9. US EPA (2010) Definition and procedures for the determination of the method detection limit. Guidelines establishing test procedures for the analysis of pollutants. Appendix B, part 136. Definition and procedures for the determination of the method detection limit. U.S. Code of Federal Regulations, Title 40. Revision 1.11.
10. US EPA (1996) Method 3510C. Separatory funnel liquid-liquid extraction, online test methods for evaluating solid waste, physical/ chemical methods (SW-846), Washington, D.C., USA., Revision 3.
11. US EPA (1996) Method 3630C. Silica gel cleanup, online test methods for evaluating solid waste, physical/ chemical methods (SW-846), Washington, D.C. USA., Revision 3.
12. Denoux, G.J.; Gardinali, P.; Wade, T.L. Quantitative determination of polynuclear aromatic hydrocarbons by gas chromatography/mass spectrometry (GC/MS)-selected ion monitoring (SIM) mode. In Sampling and analytical methods of the National Status and Trends Program Mussel Watch Project: 1993–1996 update, Lauenstein, G.G.; Cantillo, A.Y. (eds). National Oceanic and Atmospheric Administration, Silver Spring, 1998, pp 129–139. 36, 63–72.
13. Rawa-Adkonis, M.; Wolska, L.; Namiesnik, J. Analytical procedures for PAH and PCB determination in water samples—error sources. *Crit Rev Anal Chem*, **2006**,
14. Smith, R.M. Before the injection—modern methods of sample preparation for separation techniques. *J Chromatogr A*, **2003**, *1000*(1-2), 3-27.
15. Garcia-Ac, A.; Segura, P.A.; Viglino, L.; Furtos, A.; Gagnon, C.; Prevost, M.; Sauve, S. On-line solid-phase extraction of large-volume injections coupled to liquid chromatography-tandem mass spectrometry for the quantitation and confirmation of 14 selected trace organic contaminants in drinking and surface water. *J Chromatogr A*, **2009**, *1216*, 8518–8527.
16. Wang, C.T.; Gardinali, P.R. Comparison of multiple API techniques for the simultaneous detection of microconstituents in water by on-line SPE-LC-MS/MS. *J Mass Spectrom*, **2012**, *47*, 1255–1268.
17. Buseti, F.; Backe, W.J.; Bendixen, N.; Maier, U.; Place, B.; Giger, W.; Field, J.A. Trace analysis of environmental matrices by large-volume injection and liquid chromatography-mass spectrometry. *Anal Bioanal Chem*, **2012**, *402*, 175–186.
18. Ramirez, C.E.; Wang, C.; Gardinali, P.R. Fully automated trace level determination of parent and alkylated PAHs in environmental waters by online SPE-LC-APPI-MS/MS. *Anal Bioanal Chem*, **2014**, *406*, 329–344., doi:10.1007/s00216-013-7436-6.
19. Smith, D.R.; Robb, D.B.; Blades, M.W. Comparison of dopants for charge exchange ionization of nonpolar polycyclic aromatic hydrocarbons with reversed-phase LC-APPI-MS. *J Am Soc Mass Spectrom*, **2009**, *20*, 73–79.
20. Cai, S.S.; Syage, J.A.; Hanold, K.A.; Balogh, M.P. Ultra performance liquid chromatography-atmospheric pressure photoionization-tandem mass spectrometry for high-sensitivity and high-throughput analysis of US Environmental Protection Agency 16 priority pollutants polynuclear aromatic hydrocarbons. *Anal Chem*, **2009**, *81*, 2123–2128.
21. Sander, L.C.; Pursch, M.; Wise, S.A. Shape selectivity for constrained solutes in reversed-phase liquid chromatography. *Anal Chem*, **1999**, *71*, 4821–4830.

22. Rimmer, C.; Sander, L.; Wise, S. Selectivity of long chain stationary phases in reversed phase liquid chromatography. *Anal Bioanal Chem*, 2005, 382, 698–707.
23. Horak, J.; Lindner, W. Contribution of sulfonyl-aromatic and sulfonic acid-aromatic interactions in novel sulfonyl/sulfonic acid-embedded reversed phase materials. *J Chromatogr A*, 2008, 1191, 141–156.
24. Wang, Z.D.; Fingas, M.; Page, D.S. Oil spill identification. *J Chromatogr A*, 1999, 843, 369–411.
25. Mahler, B.J.; Van Metre, P.C.; Crane, J.L.; Watts, A.W.; Scoggins, M.; Williams, E.S. Coal-tar-based pavement sealcoat and PAHs: implications for the environment, human health, and stormwater management. *Environ Sci Technol*, 2012, 46, 3039–3045.
26. Watts, A.W.; Ballester, T.P.; Roseen, R.M.; Houle, J.P. Polycyclic aromatic hydrocarbons in stormwater runoff from sealcoated pavements. *Environ Sci Technol*, 2010, 44, 8849–8854.
27. Mahler, B.J.; Van Metre, P.C.; Bashara, T.J.; Wilson, J.T.; Johns, D.A. Parking lot sealcoat: an unrecognized source of urban polycyclic aromatic hydrocarbons. *Environ Sci Technol*, 2005, 39, 5560–5566.

[www.thermofisher.com](http://www.thermofisher.com)

©2016 Thermo Fisher Scientific Inc. All rights reserved. Instant Ocean is a registered trademark of Spectrum Brands, Inc. All other trademarks are the property of Thermo Fisher Scientific and its subsidiaries. This information is presented as an example of the capabilities of Thermo Fisher Scientific products. It is not intended to encourage use of these products in any manner that might infringe the intellectual property rights of others. Specifications, terms and pricing are subject to change. Not all products are available in all countries. Please consult your local sales representative for details.

<b>Africa</b> +43 1 333 50 34 0	<b>Denmark</b> +45 70 23 62 60	<b>Japan</b> +81 45 453 9100	<b>Singapore</b> +65 6289 1190
<b>Australia</b> +61 3 9757 4300	<b>Europe-Other</b> +43 1 333 50 34 0	<b>Latin America</b> +1 561 688 8700	<b>Spain</b> +34 914 845 965
<b>Austria</b> +43 810 282 206	<b>Finland</b> +358 9 3291 0200	<b>Middle East</b> +43 1 333 50 34 0	<b>Sweden</b> +46 8 556 468 00
<b>Belgium</b> +32 53 73 42 41	<b>France</b> +33 1 60 92 48 00	<b>Netherlands</b> +31 76 579 55 55	<b>Switzerland</b> +41 61 716 77 00
<b>Canada</b> +1 800 530 8447	<b>Germany</b> +49 6103 408 1014	<b>New Zealand</b> +64 9 980 6700	<b>UK</b> +44 1442 233555
<b>China</b> 800 810 5118 (free call domestic) 400 650 5118	<b>India</b> +91 22 6742 9494	<b>Norway</b> +46 8 556 468 00	<b>USA</b> +1 800 532 4752
	<b>Italy</b> +39 02 950 591	<b>Russia/CIS</b> +43 1 333 50 34 0	

**Thermo**  
SCIENTIFIC

A Thermo Fisher Scientific Brand

# Quantification of Haloacetic Acids in Tap Water Using a Dedicated HAA LC Column with LC-MS/MS Detection

Thermo Fisher Scientific, San Jose, CA

## Key Words

Haloacetic acid, Water Supply Act, LC-MS/MS, TSQ Quantum Ultra, Acclaim HAA HPLC column

## Goal

To develop an LC-MS/MS method for measuring haloacetic acids in tap water using a dedicated HPLC column.

## Introduction

In April 2012, methods provided by the Japanese Ministry of Health, Welfare and Labour based on provisions in the Water Quality Standards Ordinance (Ministry of Health, Welfare and Labour, Notification 261, July 2003) were revised, and the inspection method for haloacetic acids (HAAs) was expanded to include an analysis method using liquid chromatography paired with mass spectrometry (LC/MS or LC-MS/MS) as an alternative to gas chromatography with mass spectrometry (GC/MS).

The LC-MS(/MS) method does not require derivatization of samples and is therefore a simple measurement method. However, tap water typically contains on the order of several to several dozen mg/L of chloride, sulfate, carbonate, and nitrate anions. When performing LC-MS analysis, these anions inhibit the ionization of haloacetic acids and cause signal suppression in the MS detector. In addition, when using a standard reversed-phase column, the retention varies depending on matrix differences, the infusion amount, and the column lot, resulting in poor recoveries, robustness, and detection limits.

A number of LC-MS/MS methods for haloacetic acids using C18 (ODS) columns have already been developed. However, separation from the many ionic matrix components contained in tap water has been insufficient in these methods. Retention times varied widely between neat standards and real samples, making it difficult to obtain reproducible results.



The Thermo Scientific™ Acclaim™ HAA column is designed for analyzing haloacetic acids in drinking water by LC/MS. It is based on mixed-mode column technology and offers reversed-phase and anion-exchange retention mechanisms that enable separation of haloacetic acids in high ion matrices. This results in robust performance in real drinking water samples that contain matrix ions. In addition, sample preparation costs are reduced because analysis is possible without sample preparation or concentration.

This application note describes the LC-MS(/MS) separation using the Acclaim HAA column for haloacetic acid analysis in drinking water.



## Experimental

### Sample Preparation

#### Preparation of standards

A methyl tertiary-butyl ether (MTBE) solution combining four types of haloacetic acids [monochloroacetic acid (MCAA), dichloroacetic acid (DCAA), trichloroacetic acid (TCAA), and monobromoacetic acid (MBAA), 100 mg/L of each, Kanto Kagaku] was used for the haloacetic acid standard solution. The solution was diluted in ultrapure water and used to prepare the calibration curve.

#### Preparation of laboratory fortified matrix

The following anions were added to a final concentration as shown:  $\text{Cl}^-$ , 35 mg/L;  $\text{SO}_4^{2-}$ , 35 mg/L;  $\text{NO}_3^-$ , 50 mg/L. Ascorbic acid was added at 10 mg/L level.

#### Preparation of the sample

After sampling the tap water, ascorbic acid was added at the level of 10 mg/L for residual chlorine removal.

### Liquid Chromatography

Equipment:	Thermo Scientific™ Dionex™ UltiMate™ 3000 RSLC system, which included the LPG-3400RS Quaternary Rapid Separation Pump, WPS-3000TRS Rapid Separation Thermostatted Wellplate Sampler, and TCC-3000RS Rapid Separation Thermostatted Column Compartment
Column:	Acclaim HAA column (2.1 x 50 mm, 3 μm), P/N SP6917
Mobile phase A:	Water (LC/MS grade)
Mobile phase B:	200 mM aqueous ammonium sulfate solution
Mobile phase C:	Acetonitrile
Gradient:	Refer to Figure 1
Flow rate:	0.3 mL/min
Operating temperature:	25.0 °C
Injection volume:	50 μL

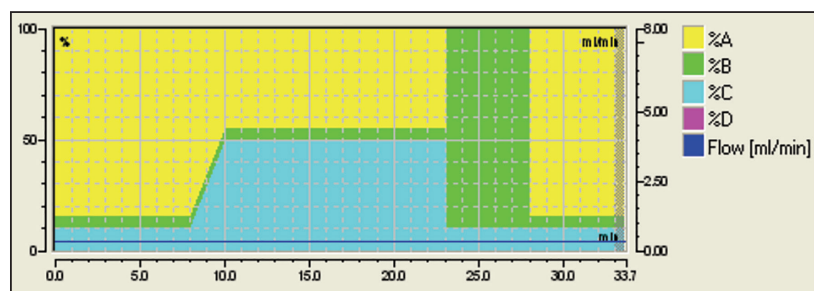

Figure 1. LC gradient

To extend the life of the columns, they should be stored in a 100 mM acetic ammonium (pH 5.0)/acetonitrile (1:4 v/v) solution.

### Mass Spectrometry

Equipment:	Thermo Scientific™ TSQ Quantum Ultra™ triple-stage quadrupole MS
Ionization method:	Negative ESI
Spray voltage:	500 V
Sheath gas:	60 arbitrary units
Aux gas:	10 arbitrary units
Capillary temperature:	250 °C
Vaporizer temperature:	400 °C
Skimmer offset:	10 V
Collision gas pressure:	Ar, 0.8 mTorr
Cycle time:	2 ms
Mass resolution:	Q1: 1.5 Da (SRM mode)
SRM transitions:	Refer to Table 1

Table 1. SRM transitions

Compound Name	Precursor (m/z)	Product (m/z)	CE (eV)
MCAA quantitation ion	93	35	10
MCAA qualifying ion	95	37	10
DCAA quantitation ion	127	83	10
DCAA qualifying ion	129	85	10
TCAA quantitation ion	161	117	10
TCAA qualifying ion	163	119	10

## Results and Discussion

### Separation of Matrix Ions

When optimizing separation conditions, it is important to adequately separate matrix ions and haloacetic acids. However, further care is required to separate chloride ions and MCAA. Detection close to the MCAA retention time was confirmed using accurate mass MS.<sup>1</sup>  $\text{Cl}^-$  ( $m/z$  35) is detected as fragment ions from  $\text{NaCl}_2^-$  ( $m/z$  93) using CID. It is therefore detected in the same transition as MCAA. If the retention mechanism is unclear, or if separation of MCAA and chloride cannot be confirmed, false quantification could result, depending on the behavior of the chloride ions. This is why processing to remove chloride ions is recommended in analysis systems using ODS columns.

In this investigation for the Acclaim HAA column, the resolution of HAAs from interfering anions in a synthetic sample matrix spiked with HAAs is demonstrated (Figure 2).



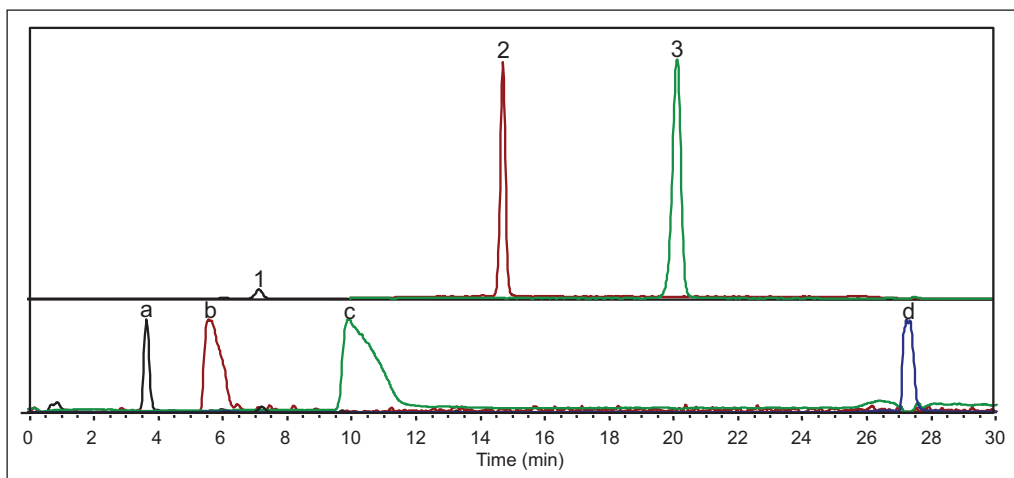

Figure 2. Separation on the Acclaim HAA column. Upper section: Haloacetic acids 1: Monochloroacetic acid (MCAA), 2: Dichloroacetic acid (DCAA), 3: Trichloroacetic acid (TCAA). Lower section: Matrix components a: Ascorbic acid, b: Chloride, c: Nitrate, d: Sulfate

### Sensitivity

Based on the Japanese Water Quality Standards Ordinance, the method needs to be able to detect three regulated haloacetic acids at concentration levels ten times lower than the regulated amounts. Among the three haloacetic acids, the compound MCAA has lowest regulated amount at 20 µg/L. The HAA column method was able to confirm all three haloacetic acids at the 2 µg/L level, which is ten times lower than 20 µg/L (Figures 3 and 4).

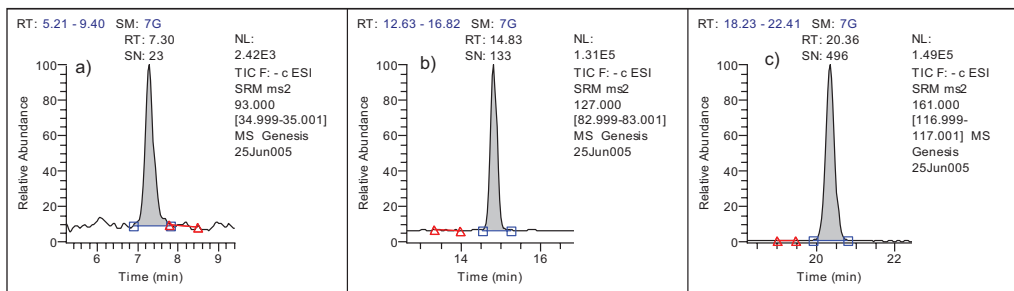

Figure 3. SRM chromatograms for 2 µg/L standard solution: a) MCAA, b) DCAA, c) TCAA

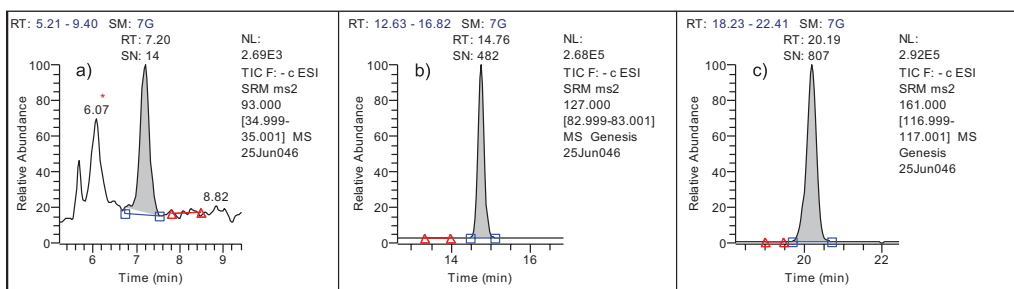

Figure 4. SRM chromatograms for tap water spiked with 2 µg/L standard solution: a) MCAA, b) DCAA, c) TCAA

\*A peak from contaminant compound sources was detected before the peak in monochloroacetic acid. The identity of this contaminant as a chloride ion cluster ion ( $\text{NaCl}_2^-$ ) was confirmed using a Thermo Scientific accurate-mass MS.

### Calibration Curve and Reproducibility

The calibration curves were created over a range from 1 to 20 µg/L with linearities greater than 0.99 (Figure 5). Reproducible results were obtained for 2 µg/L of standard solution and for tap water spiked with 2 µg/L of standard solution. Coefficients of variation were less than 1.6% (Table 2).

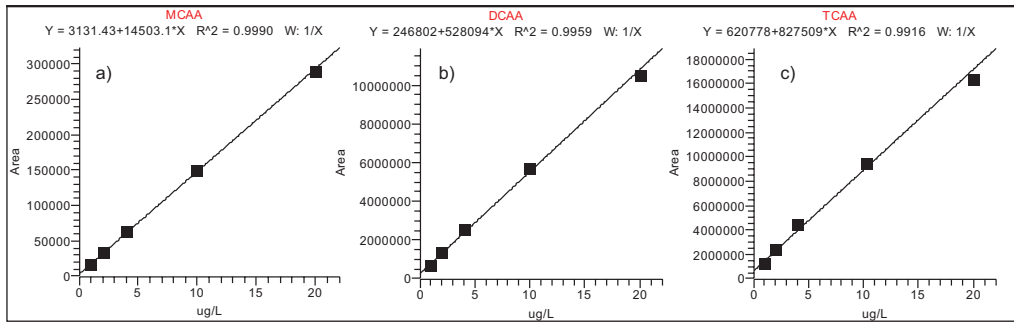

Figure 5. Calibration curves: a) MCAA, b) DCAA, c) TCAA

Table 2. Area value reproducibility for 2 µg/L of standard product and 2 µg/L of spiked tap water

	MCAA		DCAA		TCAA	
	Standard 2 µg/L	2 µg/L of spiked tap water	Standard 2 µg/L	2 µg/L of spiked tap water	Standard 2 µg/L	2 µg/L of spiked tap water
Blanks (ultrapure or tap water)	NF	6136	NF	2013784	NF	3602064
n=5 (area value)	33492	33192	1369465	3000890	2434743	5301570
	32335	33581	1355191	3079005	2465008	5241249
	32605	34016	1361893	3083660	2476721	5325868
	33295	34005	1381170	3059149	2472097	5257085
	33406	34025	1387243	3061388	2474253	5281431
%CV	1.6%	1.1%	1.0%	1.1%	0.7%	0.6%

### Confirmation of Recovery Level

A spike recovery test was performed for the tap water sample spiked with standards to 2 µg/L. Good recoveries in the range of 92% to 101% were obtained (Table 2). The same test was performed for the spiked fortified matrix sample and favorable results were obtained (Table 3).

Table 3. Recovery levels in 2 µg/L of spiked tap water and 2 µg/L of added laboratory fortified matrix

	MCAA		DCAA		TCAA	
	2 µg/L spiked tap water	2 µg/L laboratory fortified matrix	2 µg/L spiked tap water	2 µg/L laboratory fortified matrix	2 µg/L spiked tap water	2 µg/L laboratory fortified matrix
Blanks (tap water or ultrapure water)	0.282	NF	3.346	NF	3.603	NF
n=5 (quantitation value)	2.090	1.910	5.215	1.894	5.656	1.894
	2.116	1.885	5.363	1.902	5.584	1.954
	2.145	1.834	5.372	1.881	5.686	1.907
	2.144	1.939	5.325	1.836	5.603	1.890
	2.146	1.863	5.330	1.871	5.632	1.860
Average value	2.128	1.886	5.321	1.877	5.632	1.901
Average value minus blank value	1.846	1.886	1.975	1.877	2.029	1.901
Recovery level	92%	94%	99%	94%	101%	95%
%RSD	1.2%	2.2%	1.2%	1.4%	0.7%	1.8%

### Accuracy and Precision

Five replicates were quantitated for spiked tap water samples (two concentrations) using a calibration curve created from the five tests. The average recovery level and %RSD for each set of replicates are reported in Table 4.

Table 4. Parallel test results

	MCAA	DCAA	TCAA
20 µg/L of spiked tap water			
Average concentration*	19.53	18.48	19.26
Recovery level	98%	91%	95%
%RSD	2%	1%	2%
2 µg/L of spiked tap water			
Average concentration*	1.82	1.96	2.16
Recovery level	91%	98%	108%
%RSD	4%	3%	6%

\*The average concentration was calculated using the value after subtracting the blank concentration.

### Conclusion

A highly sensitive LC-MS/MS method for measuring haloacetic acids using a dedicated Acclaim HAA HPLC column has been established. Under these analysis conditions, the ionization-inhibiting chloride ions, nitric acid ions, sulfuric acid ions, and haloacetic acids can be separated, making it possible to perform reliable measurements even when interfering anions are not removed using an SPE cartridge or alternative sample preparation. In addition, reproducible results were obtained for samples at concentrations more than ten times lower than regulated amounts. Accuracy and precision in tap water was confirmed in repeated testing.

## Reference

1. Oral presentation 2E-5 at the 2012 Japan Society for Environmental Chemistry Symposium, “Quantification analysis of haloacetic acid based on LC-MS/MS using mixed mode columns”.

[www.thermofisher.com](http://www.thermofisher.com)

©2016 Thermo Fisher Scientific Inc. All rights reserved. All trademarks are the property of Thermo Fisher Scientific and its subsidiaries. This information is presented as an example of the capabilities of Thermo Fisher Scientific products. It is not intended to encourage use of these products in any manners that might infringe the intellectual property rights of others. Specifications, terms and pricing are subject to change. Not all products are available in all countries. Please consult your local sales representative for details.

<b>Africa-Other</b> +27 11 570 1840	<b>Denmark</b> +45 70 23 62 60	<b>Japan</b> +81 45 453 9100	<b>Singapore</b> +65 6289 1190
<b>Australia</b> +61 3 9757 4300	<b>Europe-Other</b> +43 1 333 50 34 0	<b>Latin America</b> +1 561 688 8700	<b>South Africa</b> +27 11 570 1840
<b>Austria</b> +43 810 282 206	<b>Finland</b> +358 9 3291 0200	<b>Middle East</b> +43 1 333 50 34 0	<b>Spain</b> +34 914 845 965
<b>Belgium</b> +32 53 73 42 41	<b>France</b> +33 1 60 92 48 00	<b>Netherlands</b> +31 76 579 55 55	<b>Sweden</b> +46 8 556 468 00
<b>Canada</b> +1 800 530 8447	<b>Germany</b> +49 6103 408 1014	<b>New Zealand</b> +64 9 980 6700	<b>Switzerland</b> +41 61 716 77 00
<b>China</b> 800 810 5118 (free call domestic) 400 650 5118	<b>India</b> +91 22 6742 9494	<b>Norway</b> +46 8 556 468 00	<b>UK</b> +44 1442 233555
	<b>Italy</b> +39 02 950 591	<b>Russia/CIS</b> +43 1 333 50 34 0	<b>USA</b> +1 800 532 4752

**Thermo**  
SCIENTIFIC

Part of Thermo Fisher Scientific

# Analysis of Haloacetic Acids in Drinking Water by IC-MS/MS

Charles Yang<sup>1</sup> and Stacy Henday<sup>2</sup>

<sup>1</sup>Thermo Fisher Scientific, San Jose, CA; <sup>2</sup>Dionex Corporation, Sunnyvale, CA

## Key Words

- TSQ Quantum Access
- EPA
- Ion chromatography
- Water analysis

## Introduction

Haloacetic acids (HAAs) are formed as disinfection by-products when water is chlorinated to remove microbial content. The chlorine reacts with naturally occurring organic and inorganic matter in the water, such as decaying vegetation, to produce by-products that include HAAs. Of the nine species of HAAs, five are currently regulated by the EPA (HAA5): monochloroacetic acid (MCAA), dichloroacetic acid (DCAA), trichloroacetic acid (TCAA), monobromoacetic acid (MBAA), and dibromoacetic acid (DBAA). The remaining four HAAs are unregulated: bromochloroacetic acid (BCAA), bromodichloroacetic acid (BDCAA), dibromochloroacetic acid (DBCAA), and tribromoacetic acid (TBAA).

According to the U.S. Environmental Protection Agency (EPA), there might be an increased risk of cancer associated with long-term consumption of water containing levels of HAAs that exceed 0.6 mg/L.<sup>1</sup> EPA Methods 552.1, 552.2, and 552.3, are used to determine the level of all nine HAAs in drinking water.<sup>2,3,4</sup> These methods require derivatization and multiple extraction steps followed by gas chromatography (GC) with electron capture detection (ECD).

In comparison to the conventional EPA methods using GC with ECD, the combination of ion chromatography and mass spectrometry (IC-MS and IC-MS/MS) offers sensitive and rapid detection without the need for sample pre-treatment. Ion chromatography is a form of liquid chromatography that uses ion-exchange resins to separate atomic and molecular ions. The retention time in the column is predominantly controlled by the interactions of the ions of the solute with the resin. Coupling IC with the highly selective detection of a triple quadrupole mass spectrometer allows unambiguous identification of substance peaks. Matrix interference effects are greatly reduced, which improves the sensitivity and lowers the detection limits.

In the method described here, water samples can be injected directly into an ion chromatography system that is coupled to a Thermo Scientific TSQ Quantum Access triple stage quadrupole mass spectrometer. The separation of all nine HAAs addressed in the EPA methods is achieved with an anion-exchange column using an electrolytically formed hydroxide gradient.

## Goal

To develop a simple, rapid, and sensitive IC-MS/MS method for analyzing haloacetic acids in water.

## Experimental Conditions

### Ion Chromatography

IC analysis was performed on a Dionex ICS 3000 system (Dionex Corporation, Sunnyvale, CA). Samples were directly injected and no sample pre-treatment was required. The IC conditions used are shown in Table 1.

Column Set:	Dionex IonPac® AG24 (2 × 50 mm), IonPac AS24 (2 × 250 mm)
Suppressor:	ASRS® 300, 2 mm
Column Temperature:	15 °C
Injection Volume:	100 µL
Flow Rate:	0.3 mL/min KOH gradient, electrolytically generated (Table 2)

Table 1. Ion chromatography system conditions

Retention Time (min)	[KOH] mM
0.00	7.0
15.1	7.0
30.8	18.0
31.0	60.0
46.8	60.0
47.0	7.0

Table 2. Electrolytically formed hydroxide gradient details

The separation performed on the IonPac AS24 column used a hydroxide gradient. It is known that hydroxide is not a recommended eluent for mass spectrometers. The addition of an ASRS 300 anion self-regenerating suppressor is critical. This suppressor is placed in line after the column and electrolytically converts the hydroxide into water, making the separation compatible with mass spectrometric detection. See Figure 1.

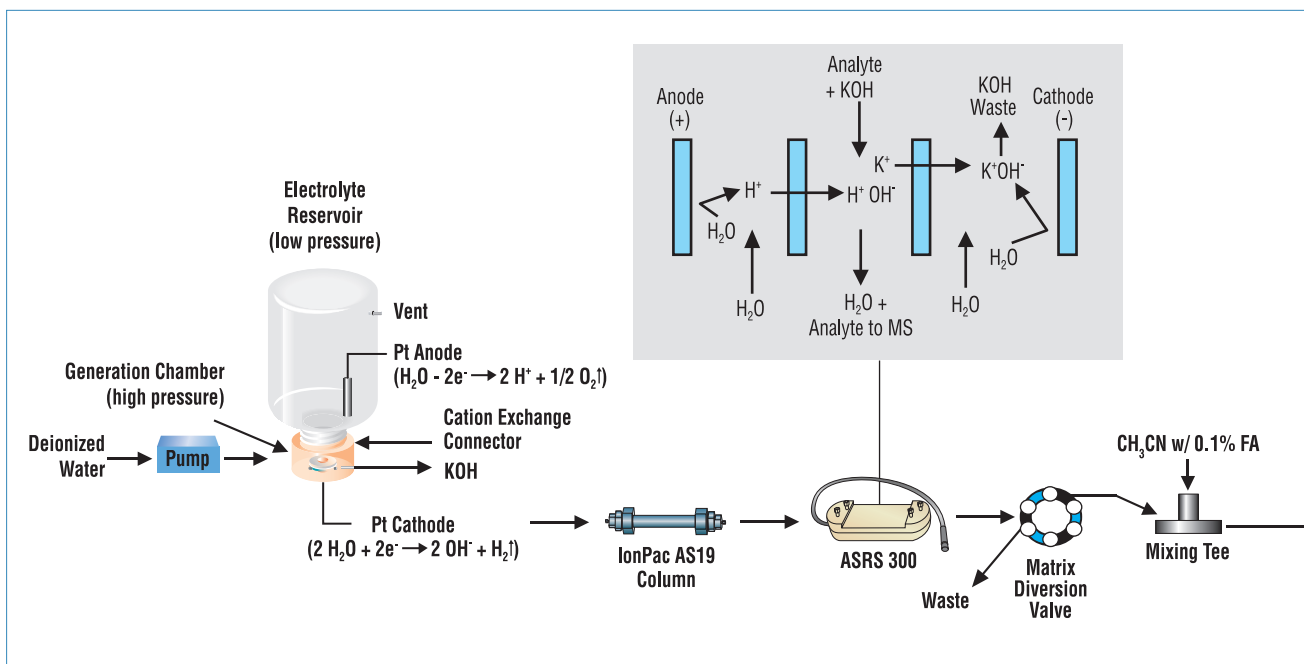

Figure 1: Flow schematic of the IC-MS/MS system

In addition, a matrix diversion valve was placed in line prior to the mass spectrometer. This valve functions to divert the high sample matrix waste from the MS source, prolonging the time in between cleanings. Acetonitrile was teed into the eluent stream after the matrix diversion valve. The acetonitrile had two main purposes: to assist in the desolvation of the mobile phase and to act as a make-up flow when the IC eluent was diverted to waste.

### Mass Spectrometry

MS analysis was carried out on a TSQ Quantum Access™ triple stage quadrupole mass spectrometer with a heated electrospray ionization (H-ESI) probe. The MS conditions used are shown in Table 3.

Ion source polarity:	Positive ion mode
Spray voltage:	4000 V
Sheath gas pressure:	40 units
Auxiliary gas pressure:	15 units
Capillary temperature:	270 °C

Table 3. Mass spectrometer conditions

Individual standards were infused into the mass spectrometer to determine optimum tube lens settings and collision energies for the product ions. Table 4 describes the MS conditions for specific HAAs and internal standards.

Analyte	Q1 (m/z)	Q3 (m/z)	CE (V)	Tube Lens (V)	Skimmer Offset (V)	Scan Time (s)
MCAA	93.01	35.60	10	26	0	1.25
MBAA	136.99	79.09	12	33	0	1.25
DCAA	127.02	83.20	11	26	0	1.25
DBAA	214.80	79.20	24	33	0	1.25
BCAA	171.00	79.20	35	44	0	1.25
TCAA	161.06	117.10	10	69	0	1.60
BDCAA	79.00	79.00	15	30	0	1.60
DBCAA	206.74	79.13	15	30	0	2.50
TBAA	250.70	79.10	25	26	0	2.50
MCAA-ISTD	94.01	35.60	10	26	0	1.25
MBAA-ISTD	138.00	79.09	12	33	0	1.25
DCAA-ISTD	128.01	84.20	11	26	0	1.25
TCAA-ISTD	162.06	118.10	10	69	0	1.60

Table 4. MS conditions for the various HAAs and internal standards

The status of the ion chromatography system was monitored at the same time as the MS data acquisition, as shown in Figure 2.

## Results and Discussion

The separation of the nine HAAs is shown in Figure 3. The selectivity of the IC-MS/MS system allows separation of the HAAs from common inorganic matrix ions. This allows matrix peaks of chloride, sulfate, nitrate, and bicarbonate to be diverted to waste during the analytical run and avoids premature fouling of the ESI-MS/MS instrument source.

An internal standard mixture of  $^{13}\text{C}$  labeled MCAA, MBAA, DCAA, and TCAA was spiked into each sample at 3 ppb. The calibration curves were generated using internal standard calibrations for all of the HAA compounds in water. Excellent linearity results were observed for all compounds as shown in Figures 4, 5, and 6. Analytes were run at levels of 250 ppt to 20 ppb. It must be noted that the TCAA analyte could not be



TSQ Quantum Access™

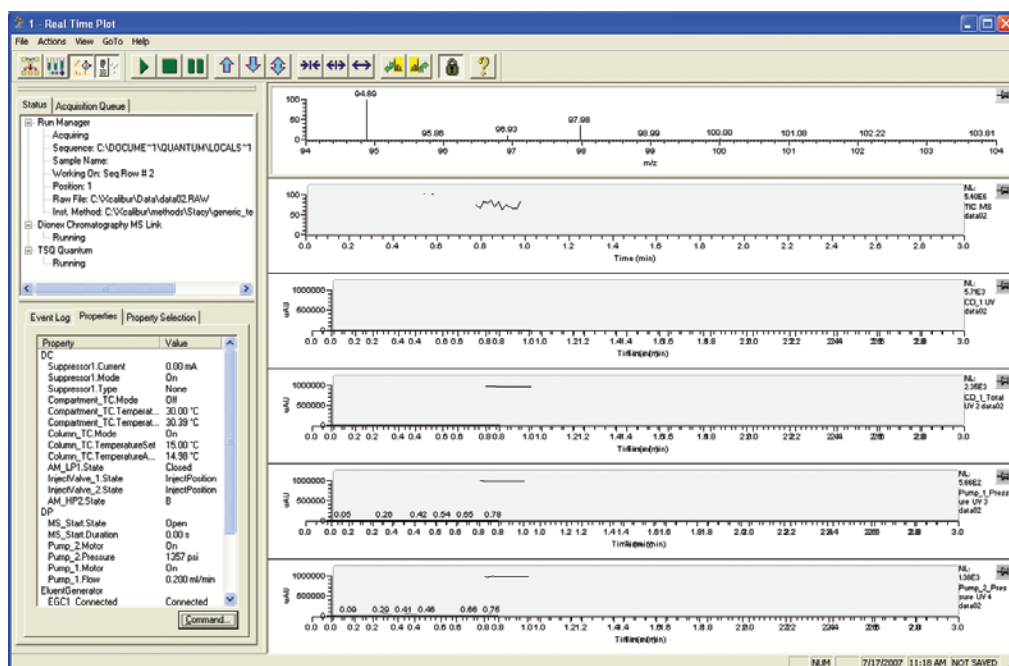
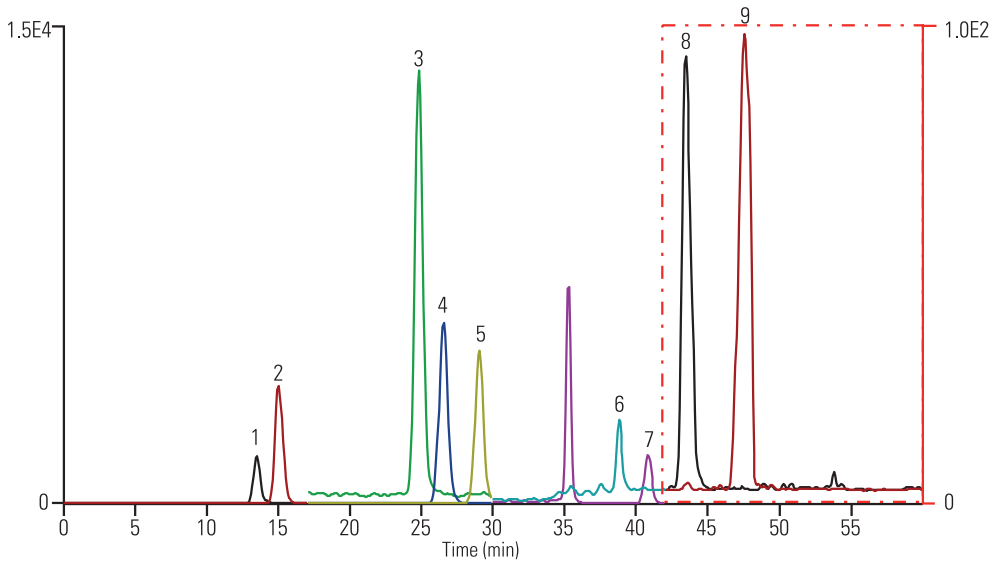

Figure 2: These chromatograms show the progress of the pump pressure and front end detector data along with the TSQ Quantum Access MS data. The left side of the screen shows the status of the ion chromatography system and the status of the TSQ Quantum Access.

detected at levels below 2.5 ppb. TCAA sensitivity is very strongly correlated with the source temperature of the mass spectrometer. To improve the TCAA detection, the temperature was lowered. However, lowering the temperature impacted the detection of the other eight analytes. This phenomenon of TCAA temperature sensitivity has been reported in studies with other MS instrumentation configurations.<sup>5</sup>

To test the recoveries of all nine HAAs, spiked matrix samples were run in a matrix of 250 mg/L of each of chloride and sulfate, 150 mg/L of bicarbonate, 30 mg/L of





- |                                  |                                     |
|----------------------------------|-------------------------------------|
| 1. Monochloroacetic acid (MCAA)  | 6. Trichloroacetic acid (TCAA)      |
| 2. Monobromoacetic acid (MBAA)   | 7. Bromodichloroacetic acid (BDCAA) |
| 3. Dichloroacetic acid (DCAA)    | 8. Dibromochloroacetic acid (DBCAA) |
| 4. Bromochloroacetic acid (BCAA) | 9. Tribromoacetic acid (TBAA)       |
| 5. Dibromoacetic acid (DBAA)     |                                     |

Figure 3: Separation and detection of the nine haloacetic acids using an ISC-3000 system with an IonPac AS24 column, coupled to a TSQ Quantum Access MS/MS system. Analyte levels were 2.5 ppb each in deionized water with an injection volume of 100  $\mu$ L.

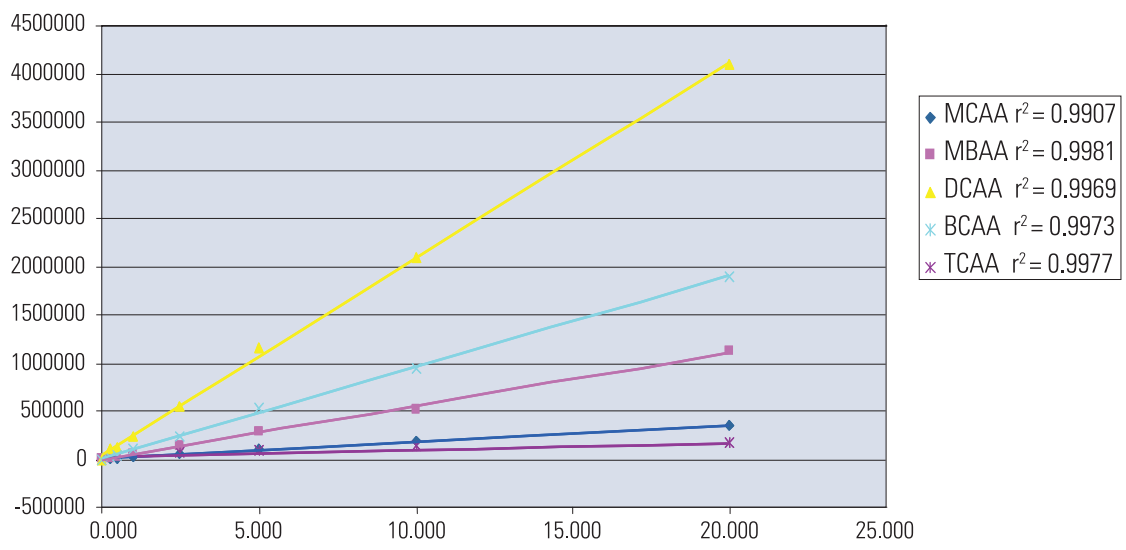

Figure 4: Calibration curve overlay of the HAA compounds in water by IC-MS/MS

nitrate, and 100 mg/L ammonium chloride preservative, for a total chloride concentration of 316 mg/L. The results are shown in Table 5. Excellent recoveries and reproducibility were achieved for most of the samples. However, difficulty was observed when quantitating low levels of DBCAA in matrix. DBCAA does not ionize as strongly as the other analytes in the method and is very susceptible to temperature changes in the column.

Method detection limits (Table 6) were calculated by

seven replicate injections of 1.0 ppb of each analyte and the equation  $MDL = t_{99\%} \times S_{(n-7)}$ , where:  $t$  is Student's  $t$  at 99% confidence intervals ( $t_{99\%, n=7} = 3.143$ ) and  $S$  is the standard deviation. Table 6 compares these results to the calculated MDL values of EPA Method 552.2, which uses liquid-liquid extraction and methylation of the carboxylic acids before determination by GC-ECD. The results obtained by the IC-MS/MS method were comparable to those achieved in EPA Method 552.2.

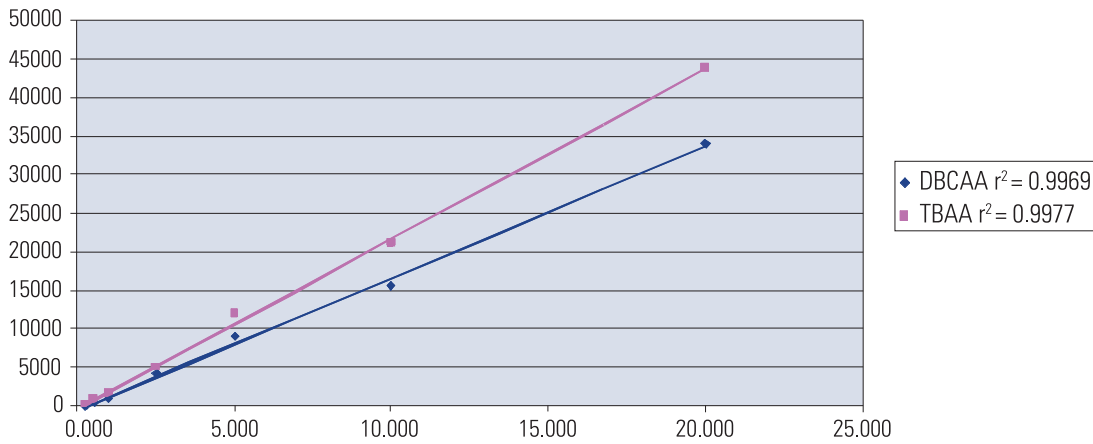

Figure 5: Overlay of calibration curves of dibromochloroacetic acid and tribromoacetic acid in water by IC-MS/MS

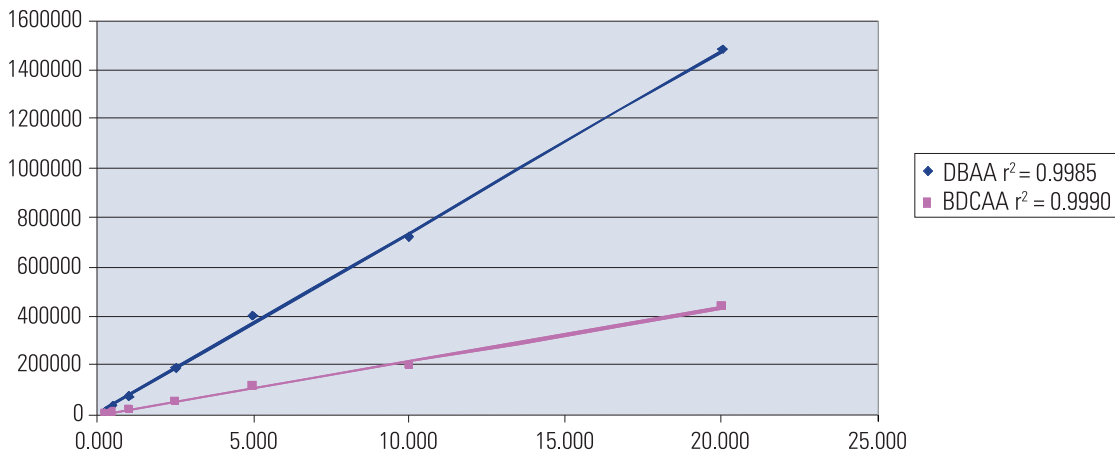

Figure 6: Overlay of calibration curves of dibromoacetic acid and bromodichloroacetic acid in water by IC-MS/MS

Analyte	Average RT	%RSD RT	Average Area	%RSD Area
MCAA	12.59	0.00	764439	2.34
MBAA	14.06	0.27	1627886	2.91
DCAA	24.44	0.02	11236488	3.98
BCAA	26.88	0.18	2468467	4.85
DBAA	30.09	0.16	731710	3.26
TCAA	39.05	0.24	4855405	10.98
BDCAA	45.13	0.04	1212887	4.78
DBCAA	43.55	0.07	1064	22.20
TBAA	47.44	0.25	1333	17.60

Table 5. Reproducibility of area and retention time in the TSQ Quantum Access for seven injections of 2 ppb concentration in simulated matrix

Analyte	Calculated MDL (µL/L)	EPA Method 552.2 MDL (µL/L)
MCAA	0.203	0.273
MBAA	0.392	0.204
DCAA	0.097	0.242
BCAA	0.136	0.251
DBAA	0.100	0.066
TCAA	0.403	0.079
BDCAA	0.159	0.091
DBCAA	0.459	0.468
TBAA	0.407	0.820

Table 6. Calculated MDL response of HAA9 on the TSQ Quantum Access

## Conclusion

IC-MS/MS is a powerful tool used in the quantitation of haloacetic acid samples. When compared to the conventional EPA methods using GC with electron capture, using IC-MS/MS to analyze for haloacetic acids saves analysts several hours of sample preparation because there is no requirement for sample pre-treatment. The resolution between the matrix peaks and haloacetic acids is excellent, which allows for minimum interference in detection.

Excellent recoveries and reproducibility were achieved when samples were spiked into a simulated matrix containing 250 mg/L of each of chloride and sulfate, 150 mg/L bicarbonate, 30 mg/L of nitrate and 100 mg/L ammonium chloride preservative for a total chloride concentration of 316 mg/L. Results are comparable to those achieved in EPA Method 552.2.

### Legal Notices

©2016 Thermo Fisher Scientific Inc. All rights reserved. IonPac, ASRS, and Dionex are registered trademarks of Dionex Corporation. All other trademarks are the property of Thermo Fisher Scientific Inc. and its subsidiaries. This information is presented as an example of the capabilities of Thermo Fisher Scientific Inc. products. It is not intended to encourage use of these products in any manners that might infringe the intellectual property rights of others. Specifications, terms and pricing are subject to change. Not all products are available in all countries. Please consult your local sales representative for details.

**View additional Thermo Scientific LC/MS application notes at: [www.thermo.com/appnotes](http://www.thermo.com/appnotes)**

## References

1. U.S. Environmental Protection Agency, *Microbial Health Effects Tables: Potential Adverse Health Effects from High/Long-term Exposure to Hazardous Chemicals in Drinking Water*, **2002**.
2. U.S. Environmental Protection Agency, Method 552.1, *Determination of Haloacetic Acids and Dalapon in Drinking Water by Ion Exchange Liquid-Solid Extraction and Gas Chromatography with Electron Capture Detection*, Rev. 1.0, **1992**.
3. U.S. Environmental Protection Agency, Method 552.2, *Determination of Haloacetic Acids and Dalapon in Drinking Water by Liquid-Liquid Extraction, Derivatization, and Gas Chromatography with Electron Capture Detection*, Rev 1.0, **1995**.
4. U.S. Environmental Protection Agency, Method 552.3, *Determination of Haloacetic Acids and Dalapon in Drinking Water Liquid-Liquid Microextraction, Derivatization, and Gas Chromatography with Electron Capture Detection*, Rev 1.0, **2003**.
5. Slingsby, R.; Saini, C.; Pohl, C.; Jack, R. *The Measurement of Haloacetic Acids in Drinking Water Using IC-MS/MS—Method Performance*, Presented at the Pittsburgh Conference, New Orleans, LA, March **2008**.

In addition to these offices, Thermo Fisher Scientific maintains a network of representative organizations throughout the world.

**Africa-Other**  
+27 11 570 1840

**Australia**  
+61 2 8844 9500

**Austria**  
+43 1 333 50 34 0

**Belgium**  
+32 2 482 30 30

**Canada**  
+1 800 530 8447

**China**  
+86 10 8419 3588

**Denmark**  
+45 70 23 62 60

**Europe-Other**  
+43 1 333 50 34 0

**Finland/Norway/Sweden**  
+46 8 556 468 00

**France**  
+33 1 60 92 48 00

**Germany**  
+49 6103 408 1014

**India**  
+91 22 6742 9434

**Italy**  
+39 02 950 591

**Japan**  
+81 45 453 9100

**Latin America**  
+1 608 276 5659

**Middle East**  
+43 1 333 50 34 0

**Netherlands**  
+31 76 579 55 55

**South Africa**  
+27 11 570 1840

**Spain**  
+34 914 845 965

**Switzerland**  
+41 61 716 77 00

**UK**  
+44 1442 233555

**USA**  
+1 800 532 4752

[www.thermo.com](http://www.thermo.com)

AN62963\_E 08/16S

# Simultaneous Determination of Oil Dispersants in Seawater and Crude Oil by LC and Tandem MS

Cesar E. Ramirez,<sup>1,2</sup> Sudha Rani Batchu,<sup>1</sup> and Piero R. Gardinali<sup>1,2</sup>

<sup>1</sup>Department of Chemistry and Biochemistry, Florida International University, Miami, FL

<sup>2</sup>Southeast Environmental Research Center, Florida International University, Miami, FL

## Key Words

Environmental analysis, oil spill, Corexit®, Deepwater Horizon, Gulf of Mexico, seawater

## Goal

To develop a liquid chromatography with tandem mass spectrometry (LC-MS/MS) method capable of simultaneously detecting and quantifying DOSS and 2-butoxyethanol in a single chromatographic run without preconcentration or cleanup steps. This method can serve as a tool to track Corexit® after its usage in oil spills and determine if Corexit EC9527A was employed.

## Introduction

On April 20, 2010 the *Deepwater Horizon* (MC-252) oil platform caught fire and sank in the Gulf of Mexico, creating a large release of oil and gas from the riser pipe and uncapped well head. Efforts to contain and clean up the spill included heavy use of oil dispersants both above and below the surface. The dispersants Corexit EC9500A and Corexit EC9527A (formerly Corexit 9500 and Corexit 9527, produced by Nalco, Naperville, IL) were approved for use in the Gulf of Mexico oil spill by the U.S. Environmental Protection Agency (EPA).<sup>1</sup> At least 1.8 million gallons of dispersants were applied during the response and recovery process.<sup>2</sup> Corexit EC9500A was the main product used in that effort.

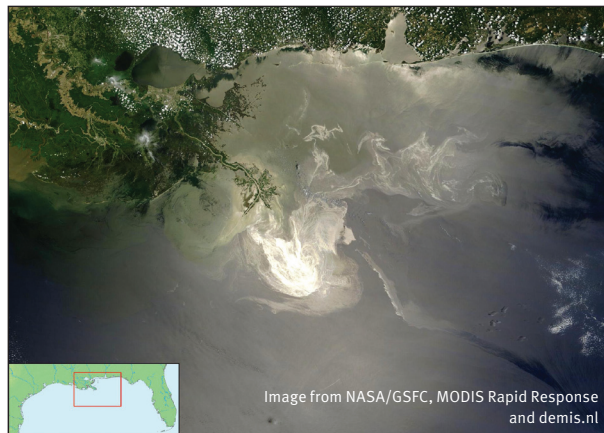

Figure 1. Satellite view of oil slick in the Gulf of Mexico on May 24, 2010

According to available material safety data sheets, the components of Corexit EC9500A are dioctyl sulfosuccinate sodium salt (DOSS) (10–30% w/w), hydrotreated light petroleum distillates (10–30% w/w), and propylene glycol (1–5% w/w).<sup>3</sup> Corexit EC9527A contains mainly 2-butoxyethanol (30–60% w/w) and DOSS (10–30% w/w).<sup>5</sup> These mixtures of solvents and surfactants reduce the interfacial tension between water and oil, facilitating the breakup of the oil into tiny droplets that are easily dispersed by wind and wave action.<sup>4</sup> The structures of 2-butoxyethanol and DOSS are shown in Figure 2.

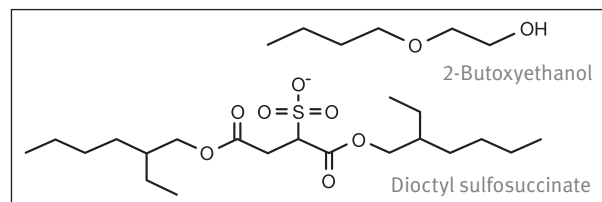

Figure 2. 2-butoxyethanol and dioctyl sulfosuccinate (DOSS), the main components of Corexit formulations

Although Corexit formulations have been found to have only low-to-moderate toxicity to most aquatic species, tracking these formulations in the environment is still a priority because much of their fate is still not well understood.<sup>6</sup> The large amounts of Corexit used in the Gulf of Mexico gave rise to the need for an analytical method capable of detecting its presence in seawater even when large dilution factors are expected.

2-butoxyethanol is of interest because it is found only in Corexit EC9527A. Despite the fact that a variety of other sources can contribute to its presence in coastal areas, chronic background environmental concentrations of 2-butoxyethanol are expected to be low because of its high miscibility in water and its fast biodegradation (half-life of 1–4 weeks) in environmental waters.<sup>7</sup>

However, applications of Corexit EC9527A in an oil spill response could potentially yield localized high concentrations of 2-butoxyethanol in surface waters. Therefore, an LC-MS/MS method capable of simultaneously detecting and quantifying the two main components of Corexit EC9527A could be useful to assess if this formulation was used.

## Experimental

### Reagents and Solvents

2-butoxyethanol was from the Acros Organics brand, part of Thermo Fisher Scientific. The surrogate standards sodium dodecyl- $d_{25}$  sulfate (DDS- $^2\text{H}_{25}$ ) and 2-butoxyethanol- $^2\text{H}_4$  were purchased from CDN Isotope Laboratories (Quebec, Canada). Certified DOSS and DOSS- $^{13}\text{C}_4$  standards were purchased from Cambridge Isotopes Laboratories (Andover, MA). Stock and working solutions of all compounds were prepared in acetonitrile. The concentrations of the stock solutions were as follows: DOSS and DOSS- $^{13}\text{C}_4$  were 100 mg/L (certified standards); 2-butoxyethanol was 8000 mg/L; 2-butoxyethanol- $^2\text{H}_4$  was 20000 mg/L; and DDS- $^2\text{H}_{25}$  was 72 mg/L. Working solutions concentrations are presented in the Sample Preparation section. Artificial seawater was prepared to 3.5% w/v using the commercially available Instant Ocean<sup>®</sup> sea salt. Chromatographic studies were performed using Fisher Chemical<sup>™</sup> Optima<sup>™</sup> LC/MS-grade formic acid, acetonitrile, and water.

### Sample Preparation

#### Seawater

Seawater samples were collected from Biscayne Bay in Florida and filtered through 0.45  $\mu\text{m}$  fiberglass filters. A 5 mL seawater subsample was placed in a glass vial containing 2.5 mL of Optima-grade acetonitrile and stored until analysis. Then, 1200  $\mu\text{L}$  of the acetonitrile-diluted seawater was transferred to a 2 mL amber LC vial already containing 47  $\mu\text{L}$  of acetonitrile and 200  $\mu\text{L}$  of artificial seawater. To that was added 18.9  $\mu\text{L}$  of DDS- $^2\text{H}_{25}$  surrogate (7.9 mg/L in acetonitrile), 18.8  $\mu\text{L}$  of 2-butoxyethanol- $^2\text{H}_4$  surrogate (8.0 mg/L in acetonitrile), and 15.8  $\mu\text{L}$  of DOSS- $^{13}\text{C}_4$  surrogate (1.9 mg/L in acetonitrile) for a final volume of 1500  $\mu\text{L}$  that maintained the 33.3% v/v of acetonitrile. The samples were thoroughly mixed using a vortex and analyzed directly by LC-MS/MS.

#### Crude oil

A sample of sweet-light crude oil from the MC-252 riser, known to contain DOSS, and a sweet-light crude oil from the Wilcox formation in Texas, were used to test the method. The crude oil samples (5.0  $\mu\text{L}$ ) were added to 2 mL amber LC vials and spiked with 37.5  $\mu\text{L}$  of 2-butoxyethanol- $^2\text{H}_4$  surrogate and 40.0  $\mu\text{L}$  of DOSS- $^{13}\text{C}_4$

surrogate. The surrogate-fortified oil was suspended in 1260  $\mu\text{L}$  of acetonitrile, capped, and mixed using a vortex for 2 min. This resulted in a two-phase system with undissolved oil on the vial walls. For instrumental analysis, an aliquot from the acetonitrile phase of each sample was added to a new 2 mL amber LC vial containing 1000  $\mu\text{L}$  of artificial seawater and 18.9  $\mu\text{L}$  DDS- $^2\text{H}_{25}$  surrogate. Acetonitrile was added to make a final volume of 1500  $\mu\text{L}$ . To minimize analysis time and ensure method uniformity, the injected sample was prepared to match the 66% seawater and 33% acetonitrile matrix of the calibration solutions and seawater samples.

### Calibration solutions

Calibration solutions were prepared in artificial seawater with the same salt and acetonitrile ratio of the analysis-ready seawater and oil samples. Then, 1000  $\mu\text{L}$  of artificial seawater was transferred to a 2 mL LC amber vial, and 18.9  $\mu\text{L}$  of DDS- $^2\text{H}_{25}$  surrogate, 18.8  $\mu\text{L}$  of 2-butoxyethanol- $^2\text{H}_4$  surrogate, and 15.8  $\mu\text{L}$  of DOSS- $^{13}\text{C}_4$  surrogate were added. Increasing amounts of DOSS and 2-butoxyethanol were added to the solutions, and acetonitrile was added to make a final volume of 1500  $\mu\text{L}$ . A seven-point calibration set was freshly prepared for each analysis day.

### Liquid Chromatography

HPLC analysis was performed using a Thermo Scientific<sup>™</sup> Accela<sup>™</sup> quaternary pump equipped with an HTC-PAL<sup>™</sup> autosampler system (CTC Analytics, Zwingen, Switzerland).

### LC Parameters

Column:	Thermo Scientific <sup>™</sup> Hypersil GOLD <sup>™</sup> aQ column (50 mm $\times$ 2.1 mm, 3 $\mu\text{m}$ particle size)		
Pre-column	Hypersil GOLD aQ (10 mm $\times$ 2.1 mm, 3 $\mu\text{m}$ particle size)		
Injection volume	20 $\mu\text{L}$		
Run time	10 min		
Flow rate	325 $\mu\text{L}/\text{min}$		
Mobile phase A	0.1% formic acid and 1% water in acetonitrile		
Mobile phase B	0.1% formic acid in water		
Gradient	Time	%A	%B
	0.0	2	98
	0.9	2	98
	3.7	98	2
	5.6	98	2
	5.9	2	98
	10.0	2	98

Instrument control and data acquisition was performed using Thermo Scientific<sup>™</sup> Xcalibur<sup>™</sup> software version 2.1.

## Mass Spectrometry

Detection of analytes was performed on a Thermo Scientific™ TSQ Quantum Access™ triple-stage quadrupole mass spectrometer equipped with a Thermo Scientific™ Ion Max™ API source with an electrospray ionization (ESI) probe. The source was operated in positive ion mode for the first 4 min of the chromatographic separation for the detection of 2-butoxyethanol and 2-butoxyethanol-<sup>2</sup>H<sub>4</sub> and then switched to negative ion mode to enable detection of DOSS, DOSS-<sup>13</sup>C<sub>4</sub>, and DDS-<sup>2</sup>H<sub>25</sub>. Optimized MS parameters were as follows:

### MS Parameters

#### Positive ion mode segment

Capillary voltage	4.5 kV
Tube lens	50 V
Auxiliary gas (N <sub>2</sub> )	15 arbitrary units

#### Negative ion mode segment

Capillary voltage	4 kV
Tube lens	-80 V
Auxiliary gas (N <sub>2</sub> )	Not used

#### Both segments

Capillary temperature	325 °C
Sheath gas (N <sub>2</sub> )	60 arbitrary units

Data were acquired in selected-reaction monitoring (SRM) mode. Identities of the precursor and product ions and the optimized collision parameters are provided in Table 1. The flow from the LC was diverted to waste for the first 1.5 min to prevent the accumulation of salts into the mass spectrometer source. A typical chromatogram for a spiked seawater sample is shown in Figure 3.

Table 1. Summary of the retention times, masses, and optimized SRM parameters

Compound	RT (min)	Parent ion (m/z)	Collision Pressure (mTorr)	Quantifying ion (m/z)	Collision energy (eV)	Qualifying ion (m/z)	Collision energy (eV)
2-butoxyethanol	3.4	119.2	0.8	63.3	5	45.4	9
2-butoxyethanol- <sup>2</sup> H <sub>4</sub>	3.4	123.2	0.8	67.3	6	-	-
DDS- <sup>2</sup> H <sub>25</sub>	4.7	290.1	1.5	98.0	42	-	-
DOSS	5.1	421.1	1.5	81.0	25	227.1	21
DOSS- <sup>13</sup> C <sub>4</sub>	5.1	425.1	1.5	81.0	25	-	-

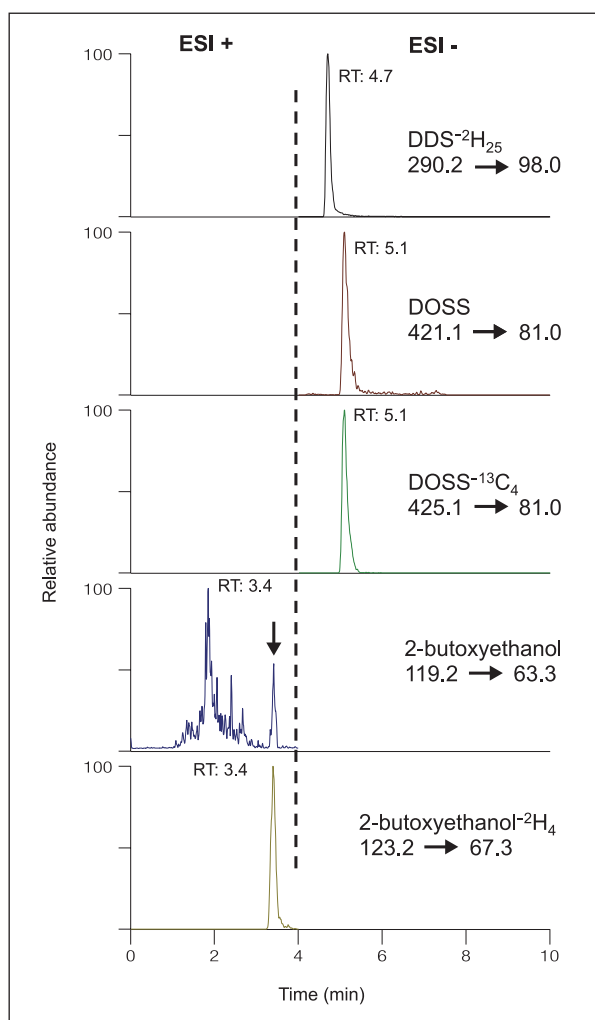

Figure 3. LC-ESI-MS/MS chromatograms of DOSS and 2-butoxyethanol in seawater at spike levels of 0.778 µg/L and 2.56 µg/L, respectively, and their surrogates



## Results and Discussion

### Chromatographic Method Development

Preliminary work indicated that 2-butoxyethanol needs to be ionized in a very narrowly defined pH range in the electrospray ionization source. Therefore, the pH was kept constant throughout the run by adding the same concentration of formic acid to both the aqueous and the organic mobile phases. A solution of 0.1% formic acid in water (pH 2.8) was used in combination with 0.1% formic acid and 1% water in acetonitrile. This approach provided acceptable peak shape and intensity for the negative mode signals and allowed good ionization of 2-butoxyethanol (Figure 3).

### Seawater Sample-Preparation Development

Signal suppression was observed for all analytes when fortified, undiluted seawater was injected relative to solutions of the same concentration in deionized water. Two experiments were conducted to determine the optimum dilution conditions that would provide adequate signals for quantification. In a first experiment, acetonitrile was compared to deionized water as a dilution solvent. A fortified seawater sample was diluted from 100% to 50%, with the dilution solvent being progressively changed from deionized water to acetonitrile, while keeping the dilution factor constant. As observed in Figure 4, the DOSS peak area increased to a maximum as the percentage of acetonitrile increased, indicating that acetonitrile was a better dilution solvent than water.

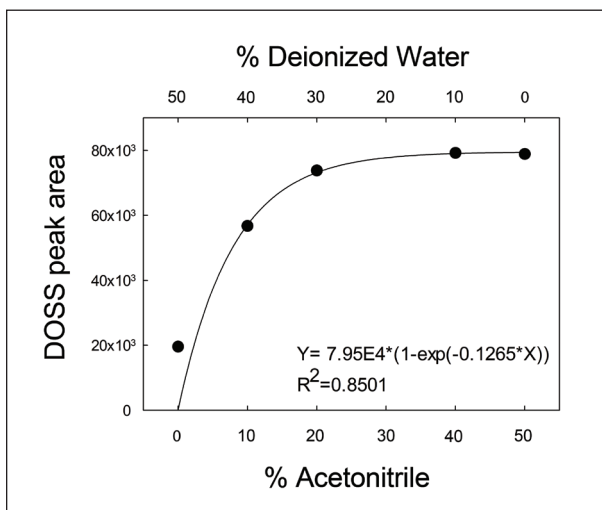

Figure 4. Comparison between acetonitrile and deionized water as solvents

In a second experiment, the optimal seawater-to-acetonitrile ratio was established by progressively diluting a fortified seawater solution. Figure 5 shows that DOSS peak area increases to a maximum between 20% and 30% v/v of acetonitrile, before following the expected dilution trend.

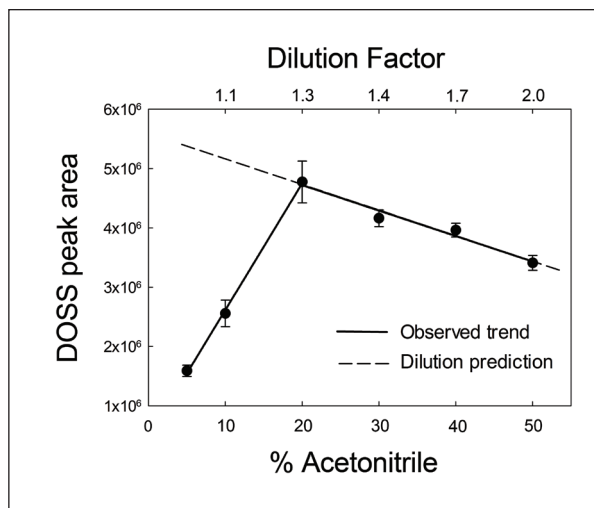

Figure 5. Dilution experiment of a 10 µg/L DOSS-fortified seawater sample

These results suggested that acetonitrile may reduce the interaction between DOSS and the glass vial surface. To investigate the storage effect of sample containers, 5 µg/L DOSS-fortified seawater samples were stored in three common types of sampling bottles (glass, PTFE, and PE) at or below 4 °C. Subsamples were taken at 0, 1, 3, and 25 hours and analyzed. Based on the dilution experiment results, a second set of fortified seawater samples were stored in the same bottle types and acetonitrile was added to 33% v/v (5:1 seawater/acetonitrile ratio). The results are shown in Figure 6. In the absence of acetonitrile, the recoveries of DOSS were severely reduced from the start of the experiment in all three types of sampling bottles. However, the samples preserved with 33% v/v acetonitrile produced stable DOSS signals up to 25 h. Therefore, dispensing 10.0 mL seawater + 5.0 mL acetonitrile into a 20 mL glass vial (33% acetonitrile) at the moment of sample collection allows for sample storage and transport to the laboratory with minimal losses.



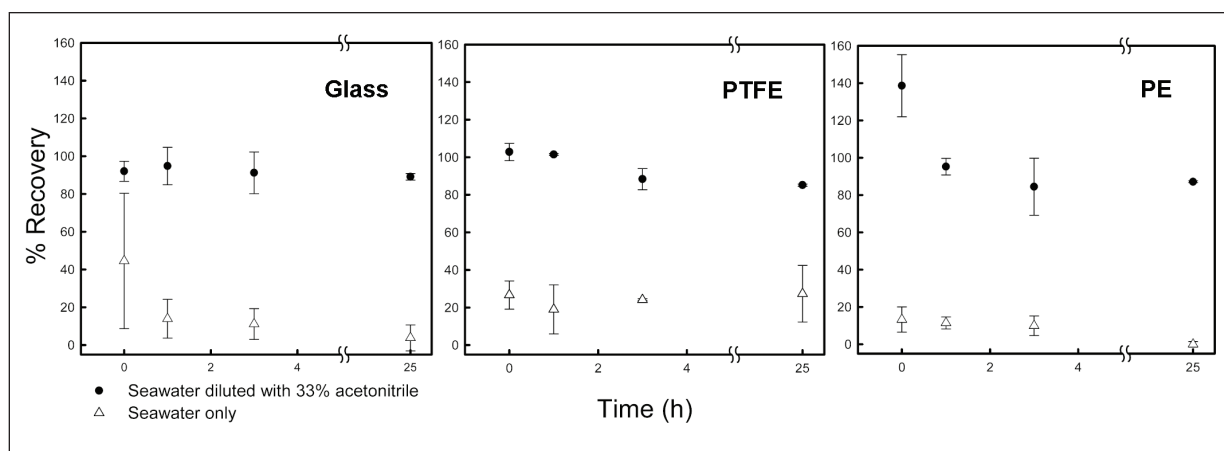

Figure 6. Glass, PTFE, and PE bottles effect on the recovery of 5 µg/L DOSS from seawater samples and acetonitrile-diluted seawater samples

### Method Performance on Seawater Samples

Calibration curves were produced by plotting the peak area ratio (analyte/isotopically labeled surrogate) against the concentration of each analyte, from the injection of seven standard solutions run in triplicates. The concentration ranges in artificial seawater varied from 0.5 to 20 µg/L and 2.5 to 30 µg/L for DOSS and 2-butoxyethanol, respectively. Linearity was observed for both analytes in the range used ( $R^2 > 0.995$ ). Since there was no extraction or clean-up step in the analysis of seawater, the quantitation of DOSS was performed directly from the DOSS/DOSS- $^{13}\text{C}_4$  peak area ratio. DDS- $^2\text{H}_{25}$  was added to match the matrix to that of the calibration curves, as this compound is necessary for quantitation in crude oil. However, the use of the DOSS/DDS- $^2\text{H}_{25}$  peak area ratio for quantitative purposes in seawater yielded very similar results, suggesting that DDS- $^2\text{H}_{25}$  could also be used as a suitable surrogate if the isotopically labeled DOSS is unavailable or is prohibitively expensive.

To calculate the method detection limits (MDL) for the target analytes, seven replicates of seawater samples were spiked at concentrations of 4.53 µg/L for DOSS and 23.3 µg/L for 2-butoxyethanol. The MDLs were calculated according to procedures outlined by the EPA.<sup>8</sup> The results are shown in Table 2. Excellent recoveries were obtained from fortified seawater samples, and the method is adaptable to other matrices like crude oil.

The EPA has listed aquatic life benchmarks of 165 µg/L for 2-butoxyethanol and 40 µg/L for DOSS and has suggested reporting limits for environmental analysis of 125 µg/L and 20 µg/L, respectively.<sup>9</sup> The detection limits reported in this work for 2-butoxyethanol (2.36 µg/L) and DOSS (1.34 µg/L) are well below the required reporting limits and are suited for environmental monitoring.

Table 2. Method detection limits and recovery in fortified seawater and light-sweet crude oil from the Wilcox formation in Texas. Water fortification levels were 23.7 and 4.53 µg/L for 2-butoxyethanol and DOSS, respectively. For the Wilcox formation crude oil, fortification levels were 16.8 and 2.45 mg/kg.

Matrix Type	Unit	2-Butoxyethanol MDL	Mean	Average % Recovery	DOSS MDL	Mean	Average % Recovery
Seawater	µg/L	2.36	22.4	96 ± 3	1.34	4.44	98 ± 9
Crude Oil	mg/kg	4.46	17.5	104 ± 8	0.723	2.26	92 ± 9

\* Method detection limit (MDL = 3.143 x SD), n=7

## Crude Oil Analysis

Calibration curves for the crude oil analysis were produced by plotting the peak-area ratio (analyte/DDS-<sup>2</sup>H<sub>2</sub>) against the analyte concentration in the injected solution and then calculating the concentration in the original weight of crude oil used. To correct for the extraction step, the average relative response factor (RRF) of each isotopically labeled surrogate was used.

Method detection limits for the crude oil analysis are shown in Table 2. Excellent recoveries were obtained for both analytes, suggesting that the single-step extraction procedure with acetonitrile is enough to quantify both tracers in the crude oil matrix. As expected, none of the analytes were detected in the sweet-light crude oil from the Wilcox formation. The oil that originated at the MC-252 riser contained 4.0 ± 0.2 mg/kg of DOSS. However, 2-butoxyethanol was not detected in the MC-252 oil sample.

## Conclusion

The method provides a simple yet robust tool for the quantification of two key indicator components of commercial Corexit formulations in seawater and crude oil. It could be used to monitor the fate and transport of dispersant in the months following an unintended oil release. This direct-injection LC-MS/MS method with simultaneous detection of both tracer compounds in two different matrices could be quickly adopted by many laboratories with LC-MS/MS capabilities.

## References

1. U.S. Environmental Protection Agency, Emergency Management. National Contingency Plan Product Schedule. [http://www.epa.gov/emergencies/content/ncp/product\\_schedule.htm](http://www.epa.gov/emergencies/content/ncp/product_schedule.htm) (Accessed on 11/12/2012.)
2. U.S. Government. 2010. Official federal portal for the Deepwater BP oil spill response and recovery. Operations and Ongoing Response August 28, 2010. <http://www.restorethegulf.gov/release/2010/08/28/operations-and-ongoing-response-august-28-2010>. (Accessed on 10/12/2010.)
3. NALCO. 2012. NALCO safety data sheet product Corexit® EC9500A. [http://www.nalcoesllc.com/nes/documents/MSDS/NESLLC-COREXIT-EC9500A-March\\_2012.pdf](http://www.nalcoesllc.com/nes/documents/MSDS/NESLLC-COREXIT-EC9500A-March_2012.pdf). (Accessed 02/05/2013)
4. Chapman, H.; Purnell, I. K.; Law, R. J.; Kirby, *Marine Pollution Bulletin* 2007, 54, 827-838. doi:10.1016/j.marpolbul.2007.03.012
5. NALCO. 2012. NALCO safety data sheet product Corexit® EC9527A. [http://www.nalcoesllc.com/nes/documents/MSDS/NESLLC-COREXIT-EC9527A-March\\_2012.pdf](http://www.nalcoesllc.com/nes/documents/MSDS/NESLLC-COREXIT-EC9527A-March_2012.pdf). (Accessed on 02/05/2013.)
6. Georges-Ares, A.; Clark, J.R. Aquatic toxicity of two Corexit® dispersants. *Chemosphere* 2000, 40, 897-906.
7. Harris, O.; Wilbur, S.; George, J.; Eisenmann, C. 1998. Toxicological Profile for 2-butoxyethanol and 2-butoxyethanol acetate. U.S. Department of Health and Human Services, Agency for Toxic Substances and Disease Registry, Atlanta, GA. USA., 296.
8. U.S. Environmental Protection Agency, 2010, U.S. Code of Federal Regulations, Title 40. Part 136, Appendix B: Definition and procedures for the determination of the method detection limit-Revision 1.11. Office of the Federal Register, Washington, DC. USA.
9. U.S. Environmental Protection Agency, 2010, Emergency Management. Methods for Detecting Dispersants in Water. 11/12/2012. (<http://www.epa.gov/bpspill/dispersant-methods.html>).

[www.thermofisher.com](http://www.thermofisher.com)

©2016 Thermo Fisher Scientific Inc. All rights reserved. Corexit is a registered trademark of Nalco Company. PAL is a trademark of CTC Analytics AG. Instant Ocean is a registered trademark of Spectrum Brands. All other trademarks are the property of Thermo Fisher Scientific Inc. and its subsidiaries. This information is presented as an example of the capabilities of Thermo Fisher Scientific Inc. products. It is not intended to encourage use of these products in any manner that might infringe the intellectual property rights of others. Specifications, terms and pricing are subject to change. Not all products are available in all countries. Please consult your local sales representative for details.

**Africa-Other** +27 11 570 1840  
**Australia** +61 3 9757 4300  
**Austria** +43 1 333 50 34 0  
**Belgium** +32 53 73 42 41  
**Canada** +1 800 530 8447  
**China** +86 10 8419 3588  
**Denmark** +45 70 23 62 60

**Europe-Other** +43 1 333 50 34 0  
**Finland/Norway/Sweden**  
 +46 8 556 468 00  
**France** +33 1 60 92 48 00  
**Germany** +49 6103 408 1014  
**India** +91 22 6742 9434  
**Italy** +39 02 950 591

**Japan** +81 45 453 9100  
**Latin America** +1 561 688 8700  
**Middle East** +43 1 333 50 34 0  
**Netherlands** +31 76 579 55 55  
**New Zealand** +64 9 980 6700  
**Russia/CIS** +43 1 333 50 34 0  
**South Africa** +27 11 570 1840

**Spain** +34 914 845 965  
**Switzerland** +41 61 716 77 00  
**UK** +44 1442 233555  
**USA** +1 800 532 4752

AN63678\_E 08/16S

**Thermo**  
 SCIENTIFIC  
 Part of Thermo Fisher Scientific

# Quantification of Polyphosphonates and Scale Inhibitors in High Ionic Strength Matrix Effluents Using IC-MS/MS

Charles Yang<sup>1</sup>, Stacy Henday<sup>2</sup>, Leo Wang<sup>2</sup>, and Bill Schnute<sup>2</sup>

<sup>1</sup>Thermo Fisher Scientific, San Jose, CA; <sup>2</sup>Dionex Corporation, Sunnyvale, CA

## Introduction

Scale deposits and corrosion formation in aqueous industrial cooling systems reduce the efficiency of heat transfer and can lead to equipment failure and increased operating costs. The addition of scale and corrosion inhibitors to cooling tower water streams helps to minimize corrosion formation by allowing dissolved minerals to remain soluble in water instead of depositing as scale. In turn, these additives permit the repeated cycling of water in cooling systems.

Before scale and corrosion inhibitors were commonly used, all cooling systems were “once-through” systems. Copious amounts of water were removed from lakes and streams by the cooling systems, greatly stressing aquatic life and negatively affecting the environment. By adding polyphosphonate compounds, such as HEDP (1-hydroxy ethylidene-1, 1-diphosphonic acid) and PBTC (2-phosphonobutane-1,2,4-tricarboxylic acid), to cooling water, corrosion and scale are minimized so that the cooling water can be cycled repeatedly through the system before it is released back into the environment.

When the cooling water is released back to the lake or stream, it must meet the standards of the United States Environmental Protection Agency (US EPA) Clean Water Act (CWA). Section 316(b) requires industrial plants to employ the best technology available to protect fish and aquatic life.<sup>1</sup> With the increased use of scale and corrosion inhibitors, polyphosphonates are now an emerging environmental contaminant and few quantitation methods exist. The ion chromatography – mass spectrometry (IC-MS/MS) technique described here provides robust quantitation in less than 20 minutes for five common scale and corrosion inhibitors in cooling water effluents – ATMP (amino trimethylene phosphonic acid), HEDP, PBTC, HPMA (hydrolyzed polymaleic anhydride), and PSO (a proprietary phosphinosuccinic oligomer)<sup>2-4</sup>.

## Goal

To develop a robust IC-MS/MS method for the quantitation of scale and corrosion inhibitors in a high anionic matrix.

## Experimental Conditions

### Ion Chromatography

IC analysis was performed on a Dionex ICS 3000 ion chromatography system (Dionex Corporation, Sunnyvale, CA). The polyphosphonate and scale inhibitor samples were directly injected and no sample pre-treatment was required. The IC conditions were as follows:

Column set: IonPac® AG21 (2.1 × 50 mm) / AS21 (2.1 × 250 mm); guard and separator columns (Dionex)

Suppressor: ASRS® 300, 2 mm; operated at 38 mA (Dionex)

Column temperature: 30 °C

Injection volume: 100 µL

Mobile phase: Potassium hydroxide, electrolytically generated with an EGC-KOH cartridge

Gradient: 0–7 min: 20 mM KOH

7–12 min: 20–60 mM KOH

12–17 min: 60 mM KOH

17.1 min: 20 mM KOH

Flow rate: 300 µL/min

Eluent generation technology allows automatic in-situ production of high-purity IC eluent (Figure 1). The pump delivers water to an eluent generator cartridge (EGC) that converts the water into a selected concentration of potassium hydroxide eluent using electrolysis. After separation on the column, the eluent enters the ASRS suppressor, which produces hydronium ions to exchange with potassium in the eluent and neutralizes the hydroxide. This makes the mobile phase compatible with an atmospheric ionization source as featured on LC-MS and LC-MS/MS systems.

## Key Words

- TSQ Quantum Access
- SRM
- Ion chromatography
- Water analysis

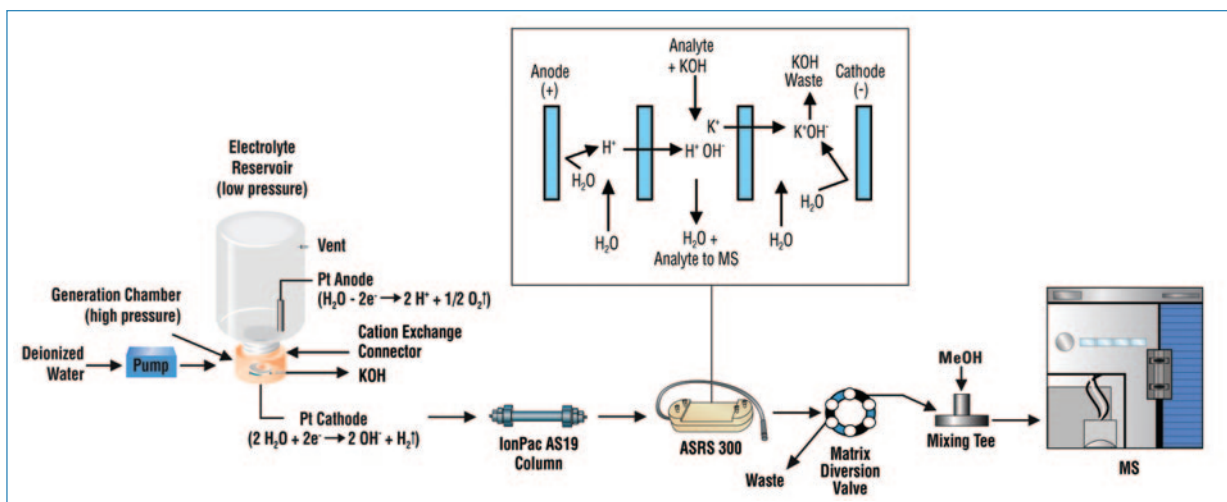

Figure 1. The flow schematic for an IC-MS application shows how an eluent generator cartridge produces potassium hydroxide. The eluent then passes through a suppressor, making it compatible with a mass spectrometer.

## Mass Spectrometry

MS analysis was carried out on a Thermo Scientific TSQ Quantum Access triple stage quadrupole mass spectrometer with an electrospray ionization (ESI) source. The MS conditions were as follows:

Ion source polarity:	Negative ion mode
Spray voltage:	4000 V
Sheath gas pressure:	40 arbitrary units
Ion sweep gas pressure:	1 arbitrary unit
Auxiliary gas pressure:	2 arbitrary units
Capillary temperature:	300 °C
Collision gas pressure:	1.2 bar
Skimmer offset:	0 V
Detection mode:	Selective reaction monitoring (SRM); see Table 1 for details.

The cooling water matrix ions eluted prior to the analytes; therefore, the first 7.5 minutes of elution were diverted from the mass spectrometer to decrease source fouling. While the eluent was diverted, a make up flow of methanol was supplied to the mass spectrometer.

Table 1. SRM conditions

Name	SRM Transitions	Collision Energy (V)	Scan Width (Da)	Scan Time (s)	Tube Lens (V)
HEDP	204.580 → 168.860	16	0.01	0.5	49
	204.580 → 186.855	13			
PBTC	268.910 → 188.925	20	0.01	0.5	45
	268.910 → 206.911	16			
ATMP	297.770 → 197.896	26	0.01	0.5	54
	297.770 → 215.870	20			
PSO*	296.850 → 118.749	27	0.01	0.5	34
	296.850 → 146.832	19			
HPMA	337.490 → 318.829	16	0.01	0.5	60
	318.960 → 230.997	13			

\*PSO is a proprietary molecule. For this oligomer, m/z 296.85 was found to be a consistent marker ion.

## Results and Discussion

Calibration curves generated on the TSQ Quantum Access™ mass spectrometer show excellent linearity using only external quantitative measurements with no internal standard correction. The detection range for all compounds was 5-5000 ppb (Figure 2 and Table 2).

The method detection limit (MDL) in matrix was calculated by seven replicate injections of 100 ppb in a simulated matrix of fluoride (20 ppm), chloride (30 ppm), nitrate (100 ppm), phosphate (150 ppm), and sulfate (150 ppm). Using the equation  $MDL = t_{99\%} \times S_{(n-1)}$ , where  $t$  equals the Student's  $t$  test at 99% confidence intervals ( $t_{99\%, (6)} = 3.143$ ) and  $S$  is the standard deviation, the MDLs for all compounds were calculated (Table 2). Figure 3 shows the response of the analytes spiked in the simulated matrix. The recoveries of all of the compounds were within 15% of the 100 ppb spike. The reproducibility of all the matrix-spiked samples was within 5%, without internal standard correction.

Table 2. Linearity and calculated detection limits of the analytes

Compound	R <sup>2</sup>	MDL in matrix (ppb)
HEDP	0.9979	8.3
PBTC	0.9975	3.7
ATMP	0.9998	16.5
HPMA	0.9985	16.5
PSO	0.9965	8.8

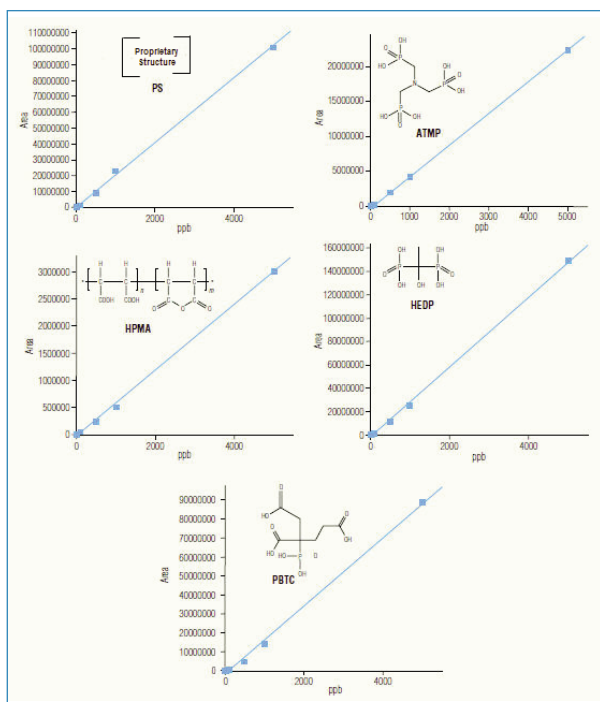

Figure 2. Calibration curves from 5 ppb to 5000 ppb for the analytes of interest, determined by linear regression analysis with equal weighting of the data.

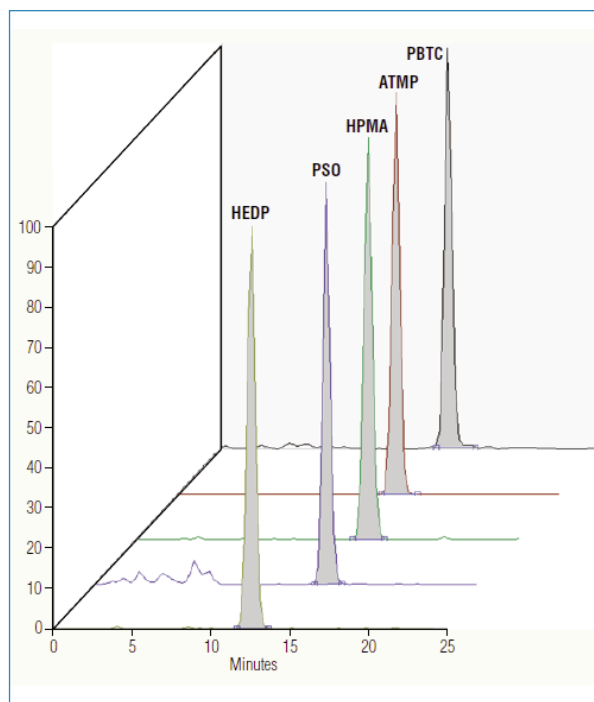

Figure 3. The response of 100 ppb analytes spiked into a high ionic strength matrix. The analytes showed excellent recoveries (within 15% of the 100 ppb spike) when spiked into the matrix.

Water treatment chemistry is a specialized field that often uses proprietary technology. As such, it is difficult to evaluate methods to reduce the environmental impact from the operation of cooling water systems. The method described here can detect the scale and corrosion inhibitors at sub-part-per-billion levels, although most cooling streams have part-per-million levels of scale and corrosion inhibitors. Any adverse matrices are diluted when the sample is diluted into the calibration range of 5-5000 ppb.

Compounds such as PSO and HPMA are proprietary blends with many components. When issued, they are sold in controlled, blended formulations. In the sample we received, one main marker and its transitions were examined. These marker ions, of  $m/z$  297 and  $m/z$  337, respectively for PSO and HMPA, showed excellent linearity over the quantitation range (Table 2).

## Conclusion

The addition of scale and corrosion inhibitors to the water stream in industrial cooling systems reduces corrosion and allows repeat water cycling. While there is no current EPA guideline for the amount of corrosion and scale inhibitors released into the environment, interest in the quantification of these products in released water has increased. The minimum detection level established by this method shows that low-level quantitation of scale and corrosion inhibitors is possible, even in a high concentration of laboratory-simulated matrix.

## References

1. U.S. Environmental Protection Agency, Clean Water Act - Sec. 316(b) - Thermal Discharges: <http://www.epa.gov/waterscience/316b/basic.htm> (Accessed 07-19-09)
2. Wanjie International Co., Phosphonates Scale and Corrosion Inhibitors: [http://www.wuzhouchem.com/cataloged/WWP\\_SCI.htm](http://www.wuzhouchem.com/cataloged/WWP_SCI.htm) (accessed 11-25-09)
3. Shangdong Taihe Water Treatment Co., Hydrolyzed Polymaleic Anhydride (HPMA): <http://www.thwater.net/03-HPMA.htm> (accessed 11-25-09)
4. Nalco Co., Phosphinosuccinic Oligomer (PSO): [http://extranet.nalco.com/PDF/o3267\\_final.pdf](http://extranet.nalco.com/PDF/o3267_final.pdf) (accessed 11-25-09)

*In addition to these offices, Thermo Fisher Scientific maintains a network of representative organizations throughout the world.*

**Africa-Other**  
+27 11 570 1840

**Australia**  
+61 2 8844 9500

**Austria**  
+43 1 333 50 34 0

**Belgium**  
+32 2 482 30 30

**Canada**  
+1 800 530 8447

**China**  
+86 10 8419 3588

**Denmark**  
+45 70 23 62 60

**Europe-Other**  
+43 1 333 50 34 0

**Finland/Norway/  
Sweden**  
+46 8 556 468 00

**France**  
+33 1 60 92 48 00

**Germany**  
+49 6103 408 1014

**India**  
+91 22 6742 9434

**Italy**  
+39 02 950 591

**Japan**  
+81 45 453 9100

**Latin America**  
+1 608 276 5659

**Middle East**  
+43 1 333 50 34 0

**Netherlands**  
+31 76 579 55 55

**South Africa**  
+27 11 570 1840

**Spain**  
+34 914 845 965

**Switzerland**  
+41 61 716 77 00

**UK**  
+44 1442 233555

**USA**  
+1 800 532 4752

**[www.thermo.com](http://www.thermo.com)**

#### Legal Notices

©2016 Thermo Fisher Scientific Inc. ASRS and IonPac are registered trademarks of Dionex Corporation. All other trademarks are the property of Thermo Fisher Scientific and its subsidiaries. All rights reserved. This information is presented as an example of the capabilities of Thermo Fisher Scientific Inc. products. It is not intended to encourage use of these products in any manners that might infringe the intellectual property rights of others. Specifications, terms and pricing are subject to change. Not all products are available in all countries. Please consult your local sales representative for details.

**View additional Thermo Scientific LC/MS application notes at: [www.thermo.com/appnotes](http://www.thermo.com/appnotes)**

AN63140\_E 08/16S

# Detection and Quantitation of Brominated and Chlorinated Hydrocarbons by DART with Linear Ion Trap and Triple Quadrupole Technology

Mary L. Blackburn<sup>1</sup>, Scott J. Harrison<sup>2</sup>, and Maria C. Prieto Conaway<sup>1</sup>

<sup>1</sup>Thermo Fisher Scientific, San Jose, CA, USA; <sup>2</sup>AgResearch, Palmerston North, New Zealand





## Overview

**Purpose:** Halogenated compounds such as brominated flame retardants (BFRs) and chlorinated pesticides (OCs) have been in use for many years. Both BFRs and OCs are persistent in the environment<sup>1</sup> and pose potential health risks. Therefore, detection and monitoring of these compounds is critical. This experiment is developed to quantitate BFRs and OCs using liquid chromatography-mass spectrometry (LC-MS).

**Methods:** The DART-SVP source (IonSense Corp.) was used to reduce sample preparation and provide ionization. Both ion trap and triple stage quadrupole (TSQ) technology were used for this study.

**Results:** Ionization modes and fragmentation determined on the linear ion trap were confirmed on the TSQ. Further optimization and breakdown curves for the TSQ method were achieved using DART-infusion of the BFRs chosen for further study.

## Introduction

Brominated hydrocarbons also known as BFRs have been used in various industries for decades. Recently, several classes of BFRs have been detected in the biosphere. OCs have also been used for many years primarily as pesticides, the most infamous of these being DDT. While most OCs have been banned in the United States, their use still occurs in developing countries. The continued use of BFRs and OCs, as well as their persistence in the environment and potential deleterious activity therein, makes the detection and monitoring of these compounds an important topic. We propose DART as a simple, rapid, easy-to-use technique; eliminating the need for chromatographic method development, and reducing or eliminating sample preparation, for detection and quantitation of both BFRs and OCs.

## Methods

### Sample Preparation

Compounds listed in Table 1 were dissolved in acetone at 1 mg/mL to make stock solutions. Stock solutions were diluted serially to give the following standards: 100 ppm, 50 ppm, 5 ppm, 1 ppm, 500 ppb, 100 ppb, 50 ppb, 10 ppb. Kepone was spiked in at a constant level of 100 ppb as a reference point. Spiked and un-spiked water samples were analyzed directly with no additional preparation.

### DART Methodology

Preliminary data was acquired on the Thermo Scientific LTQ linear ion trap mass spectrometer using the DART-SVP source in 1D transmission mode, with a grid voltage of 300V and temperature of 200 °C. Full scan and MS/MS data were acquired for all compounds. To confirm the linear ion trap data, further optimize ionization, and obtain collision energies (CE) breakdown curves, the DART-SVP source was run in direct infusion mode on the Thermo Scientific TSQ Quantum Access MAX triple stage quadrupole mass spectrometer. Subsequent quantitation data on the TSQ Quantum Access MAX™ MS was obtained with the DART-SVP source in 1D transmission mode, with a grid voltage of 300V and temperature of 400 °C.

### Mass Spectrometry

Negative ion full scan and MS/MS mass spectral data was acquired on the LTQ™ linear ion trap MS with the following conditions: capillary temperature 270 °C, tube lens -100V. Negative mode selective ion monitoring (SIM) and selected reaction monitoring (SRM) were acquired on the TSQ Quantum Access MAX MS with the following conditions: capillary temperature 200 °C, skimmer offset 0V. SRM data was acquired with a Q1 and Q3 resolution of 0.7 FWHM, collision gas pressure of 1.5, with compound dependent CE and tube lens voltages.

## Results

### Compound optimization

Initial studies were performed on the linear ion trap MS due to the full scan sensitivity and high scan rate which is necessary when optimizing on spots with an average signal duration of 5 to 10 seconds that results when using the DART-SVP in 1D transmission mode. All but three of the selected compounds were detected and precursor masses were determined (see Table 1). Additionally, MS/MS spectra were acquired to determine potential fragments for quantitation (see Figure 2). Confirmation of the precursor masses was achieved on the TSQ MS using the DART-SVP in direct infusion mode.

**TABLE 1. Compounds analyzed with structures, formulas, proposed ionization mechanisms, observed precursors, and monitored SRM transitions. All precursor masses detected by the linear ion trap were confirmed on the triple stage quadrupole with DART-SVP infusion. Compounds marked with an asterisk were not detected initially but were seen with DART-SVP infusion.**

Compound	Molecular Structure	Formula	Theoretical monoisotopic (most intense isotope) m/z	Observed precursor for MS/MS and proposed ionization mechanism	Fragments (monitored SRM transitions)
allyl 2,4,6-tribromophenyl ether*		C <sub>9</sub> H <sub>7</sub> Br <sub>3</sub> O	367.8 (369.8)	306.9 [M+OH-HBr] <sup>+</sup> C <sub>9</sub> H <sub>7</sub> Br <sub>2</sub> O <sub>2</sub>	265.8
1,2,5,6-tetrabromocyclooctane*		C <sub>8</sub> H <sub>12</sub> Br <sub>4</sub>	423.8 (427.8)	459.6 [M+O <sub>2</sub> ] <sup>+</sup> C <sub>8</sub> H <sub>12</sub> Br <sub>4</sub> O <sub>2</sub>	Weak fragmentation
2,3,4,5,6-pentabromoethylbenzene		C <sub>8</sub> H <sub>5</sub> Br <sub>5</sub>	495.6 (499.63)	436.7 [M+OH-HBr] <sup>+</sup> C <sub>8</sub> H <sub>5</sub> Br <sub>4</sub> O	81.0, 274.7, 356.6
2-bromo-1,3-bis(dibromomethyl)benzene		C <sub>8</sub> H <sub>5</sub> Br <sub>5</sub>	495.6 (499.6)	370.8 [M+O+OH-2HBr] <sup>+</sup> C <sub>8</sub> H <sub>4</sub> Br <sub>3</sub> O <sub>2</sub>	79.0, 81.0, 326.7
hexabromobenzene		C <sub>6</sub> Br <sub>6</sub>	545.51 (551.5)	486.5 [M+OH-HBr] <sup>+</sup> C <sub>6</sub> Br <sub>5</sub> O	378.0, 380.0
tetrabromobisphenol A		C <sub>15</sub> H <sub>12</sub> Br <sub>4</sub> O <sub>2</sub>	539.8 (543.8)	542.8 [M-H] <sup>-</sup> C <sub>15</sub> H <sub>11</sub> Br <sub>4</sub> O <sub>2</sub>	290.8, 417.8, 419.8
tris(2,3-dibromopropyl)isocyanurate		C <sub>12</sub> H <sub>15</sub> Br <sub>6</sub> N <sub>3</sub> O <sub>3</sub>	722.6 (728.6)	727.5 [M-H] <sup>-</sup> C <sub>12</sub> H <sub>14</sub> Br <sub>6</sub> N <sub>3</sub> O <sub>3</sub>	79.0, 81.0
tetrabromophthalic anhydride*		C <sub>8</sub> Br <sub>4</sub> O <sub>3</sub>	459.7 (463.7)	398.7 [M+OH-HBr] <sup>+</sup> C <sub>8</sub> Br <sub>3</sub> O <sub>4</sub>	326.8, 354.8
1,2,5,6,9,10-hexabromocyclododecane		C <sub>12</sub> H <sub>18</sub> Br <sub>6</sub>	635.7 (641.6)	640.62 [M-H] <sup>-</sup> C <sub>12</sub> H <sub>17</sub> Br <sub>6</sub>	79.0, 81.0
kepone		C <sub>10</sub> Cl <sub>10</sub> O	485.7 (489.7)	506.8 [M+OH] <sup>+</sup> C <sub>10</sub> Cl <sub>10</sub> O <sub>2</sub> H	424.8, 426.8

Direct infusion was achieved by connecting an electrospray needle via peek tubing to a syringe pump. The needle was held by forceps in a multi-positional clamp. The needle was then positioned directly between the DART-SVP source and the ceramic capillary interfaced with the mass spectrometer. Compounds were infused at rates ranging from 1 to 5  $\mu$ L/min and a concentration of 100 ppm. The infusion studies showed that the compounds required higher DART-SVP source temperatures for optimum ionization than were initially utilized. The optimum temperature was determined to be 400 °C. The results of the infusion studies shown in Figure 1 confirm the linear ion trap MS data. It also shows it was possible to ionize the three compounds that were not initially observed on the linear ion trap MS due to the DART-SVP source temperature being too low.

It is interesting to note that the results shown in Figure 1 demonstrate a pattern in the ionization pathway of the molecules. Compounds containing a hydrogen bonded to a non-aromatic carbon, such as tetrabromobisphenol A, tended to lose a proton to form the [M-H]<sup>-</sup> species. Alternatively, compounds containing no hydrogen atoms or hydrogen bonded to an aromatic carbon tended to add OH<sup>-</sup> and lose HBr.

In addition to optimizing precursor detection the DART-SVP infusion method was used to determine: tube lens values, fragment ions and CE breakdown curves for the quantitative experiments on the TSQ MS. In the process of acquiring the CE breakdown curves it was noted that the fragments differed from those observed in the linear ion trap, as shown in Figure 2. This is not surprising as the fragmentation in the TSQ MS is more energetic than that in the linear ion trap MS.

**FIGURE 1. TSQ full scan infusion data. Acquired spectra versus theoretical spectra for observed precursors demonstrating proposed ionization mechanisms. Top spectrum in each pair is the acquired data; lower spectrum is theoretically generated spectrum based on proposed formulas.**

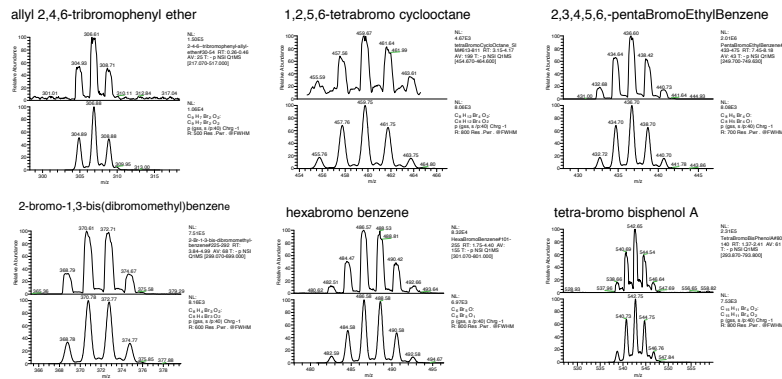

Panel B of Figure 2 depicts a spectrum automatically generated on the TSQ MS from the auto-tune procedure in which the CE is automatically stepped from low to high and the most intense fragments are automatically selected as transition ions (Table 1).

### Quantitative experiments

After the infusion experiments, the 10-spot linear rail for 1D transmission experiments was installed. Kepone was selected as a reference compound, due to its highly efficient ionization, and spiked into all samples at a level of 100 ppb. Data was acquired in the free run mode with a constant rail speed of 0.7 mm/sec. This mode was chosen to generate the best approximation of Gaussian shaped peaks (Figure 3) and avoid spiking that can occur when the rail moves discretely to each spot.

The results of calibrators and samples are shown in Figure 3, each peak represents the signal from a single spot. Each chromatogram should contain a total of ten peaks from one pass through the 10-spot rail. 5  $\mu$ L of sample was applied to each spot in a horizontal line through the center of the spot. This process was repeated twice for a total application of 10  $\mu$ L. Several of the compounds were detected as low as 50 ppb, specifically tetrabromobisphenol A, 1,2,5,6,9,10-hexabromocyclododecane, and tris(2,3-dibromopropyl)isocyanurate. Unfortunately, the reproducibility at this level was poor. It was determined that each compound responded differently. Thus, it was not possible to normalize responses with kepone, our reference compound. Poor reproducibility was most likely a function of the spotting technique and could easily have been compensated for by the use of labeled internal standards. However, even given the variation in response from spot to spot it was possible to obtain some quantitative information. Peak areas for each chromatogram were exported to Excel.

**FIGURE 2. MS/MS Spectra for tetrabromobisphenol A. Panel A depicts linear ion trap data, Panel B depicts triple quad data. Linear ion trap data was acquired with a normalized collision energy of 35V, triple quadrupole data was generated with stepped collision energy in the auto-tune process.**

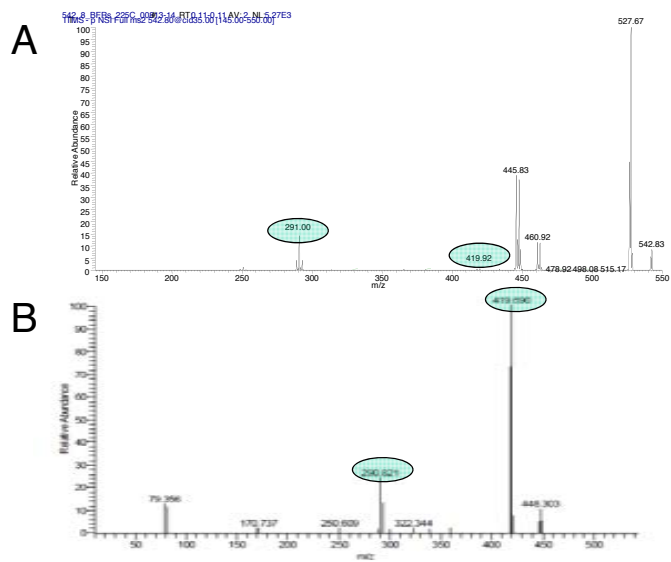

**FIGURE 3. TSQ MS data for calibrators and unknowns. Each panel depicts the compounds in the following order from top to bottom:**

- 1) kepone
- 2) allyl 2,4,6-tribromophenyl ether
- 3) 2-bromo-1,3-bis(dibromomethyl)benzene
- 4) tetrabromophthalic anhydride
- 5) 2,3,4,5,6-pentabromoethylbenzene
- 6) hexabromobenzene
- 7) tetrabromobisphenol A
- 8) 1,2,5,6,9,10-hexabromocyclododecane
- 9) tris(2,3-dibromopropyl)isocyanurate

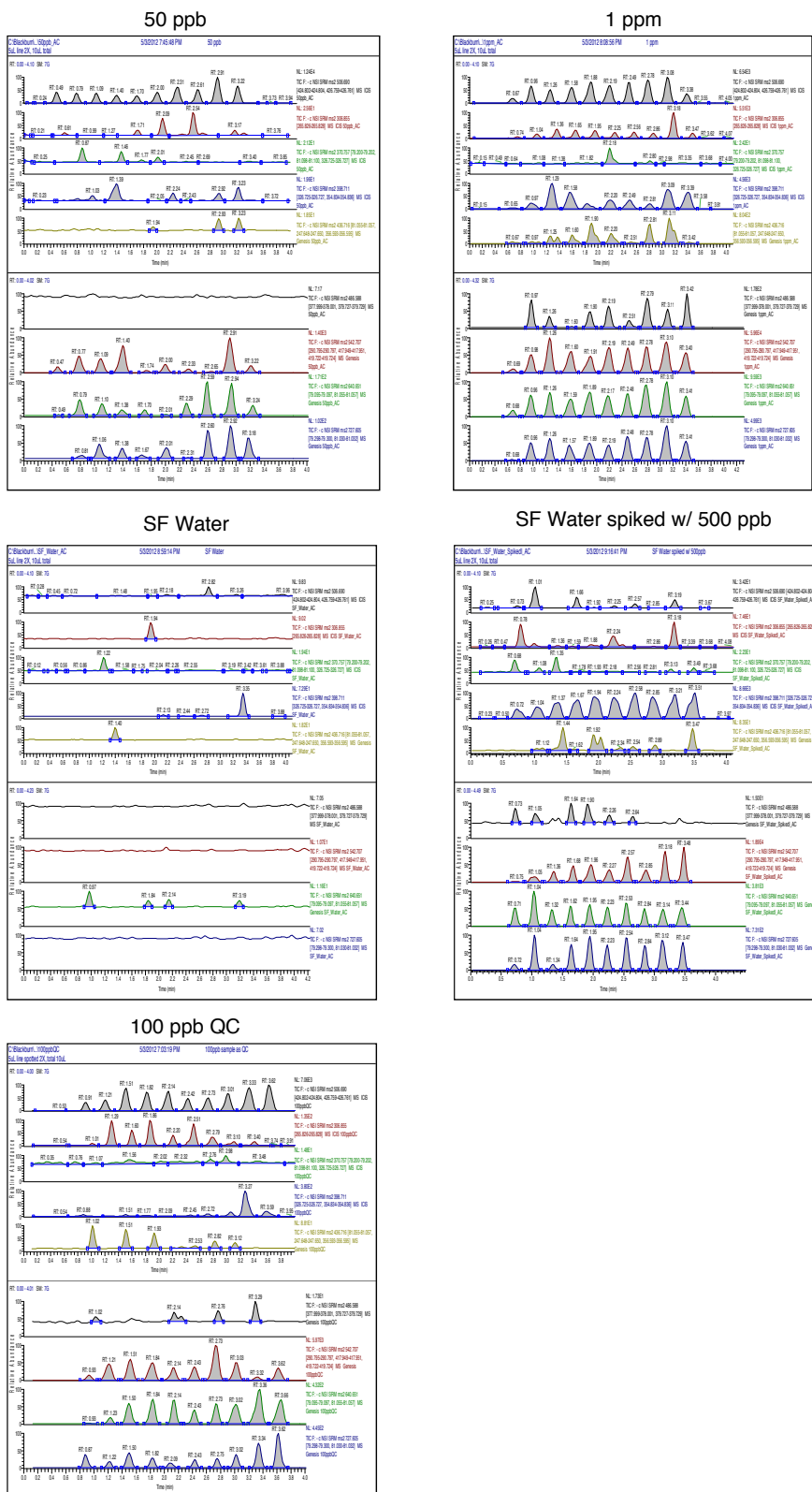

All compound peaks corresponding to each kepone peak were averaged to generate a data point at each level. A minimum of nine peaks were required for the level to be included in a curve. Chromatograms and results for some of the compounds are shown in Figure 4.

**FIGURE 4. Calibration curves and results for; tris(2,3-dibromopropyl)isocyanurate, 1,2,5,6,9,10-hexabromocyclododecane, tetrabromobisphenol A**

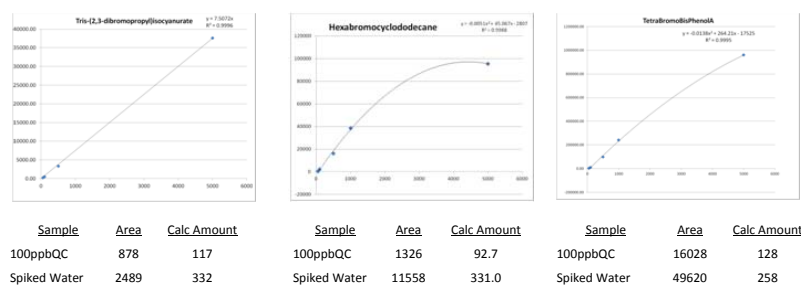

A San Francisco (SF) water sample was analyzed by spotting 10 $\mu$ L, as previously described, and drying at 60 °C for ten minutes. No BFRs or OCs were detected (Figure 3). It is interesting to note that when the 500 ppb standard was spiked into the SF water sample the compound response varied greatly, most noticeably with an enhancement of tetrabromophthalic anhydride and a lower-than-expected response for tetrabromobisphenol A, 1,2,5,6,9,10-hexabromocyclododecane, and tris(2,3-dibromopropyl)isocyanurate (Figure 3). This variation indicates the importance of applying the standards in the same matrix as the sample that is being analyzed. Thus, while sample variation was observed, the method shows promise as a quick, simple method of detecting and quantitating BFRs and OCs, with additional work to address the effect of labeled standards and matrixes.

## Conclusions

- The linear ion trap MS with the DART-SVP in 1D transmission mode provided an excellent method of detecting BFRs and OCs, providing precursor and fragment ion information.
- The Quantum Access MAX MS with the DART-SVP in direct infusion mode generated full scan spectra for BFRs and OCs that 1) generated a high quality match to theoretical spectra confirming the precursor information provided by the linear ion trap and 2) facilitated the automated optimization of tube lens voltages, transition fragments, and collision energies.
- BFR and OC quantitative experiments were performed and LODs were found to be as low as 50 ppb for several compounds.
- Further work to minimize sample response variation and investigate the effect of matrix on sample response will be performed.
- DART-SVP provides a quick simple method of analyzing BFRs and OCs without the need for sample preparation or chromatographic method development.

## References

1. Emerging Brominated Flame Retardants in the Environment, Cynthia A. de Wit, Amelie Kierkegaard, Niklas Ricklund, and Ulla Sellström, E. Eljarrat and D. Barcelo´ (eds.), Brominated Flame Retardants, Springer-Verlag Berlin Heidelberg 2010, Published online: 9 December 2010

## Acknowledgements

We would like to thank IonSense Corporation for providing the DART-SVP source.

Excel is a trademark of Microsoft Corporation. DART-SVP is a trademark of IonSense. All other trademarks are the property of Thermo Fisher Scientific and its subsidiaries.

This information is not intended to encourage use of these products in any manners that might infringe the intellectual property rights of others.

[www.thermofisher.com](http://www.thermofisher.com)

©2016 Thermo Fisher Scientific Inc. All rights reserved. All trademarks are the property of Thermo Fisher Scientific Inc. and its subsidiaries. This information is presented as an example of the capabilities of Thermo Fisher Scientific Inc. products. It is not intended to encourage use of these products in any manners that might infringe the intellectual property rights of others. Specifications, terms and pricing are subject to change. Not all products are available in all countries. Please consult your local sales representative for details.

**Africa-Other** +27 11 570 1840  
**Australia** +61 3 9757 4300  
**Austria** +43 1 333 50 34 0  
**Belgium** +32 53 73 42 41  
**Canada** +1 800 530 8447  
**China** +86 10 8419 3588  
**Denmark** +45 70 23 62 60

**Europe-Other** +43 1 333 50 34 0  
**Finland/Norway/Sweden**  
+46 8 556 468 00  
**France** +33 1 60 92 48 00  
**Germany** +49 6103 408 1014  
**India** +91 22 6742 9434  
**Italy** +39 02 950 591

**Japan** +81 45 453 9100  
**Latin America** +1 561 688 8700  
**Middle East** +43 1 333 50 34 0  
**Netherlands** +31 76 579 55 55  
**New Zealand** +64 9 980 6700  
**Russia/CIS** +43 1 333 50 34 0  
**South Africa** +27 11 570 1840

**Spain** +34 914 845 965  
**Switzerland** +41 61 716 77 00  
**UK** +44 1442 233555  
**USA** +1 800 532 4752

PN63560\_E 08/16S

**Thermo**  
S C I E N T I F I C  
Part of Thermo Fisher Scientific





# Determination of 1,4-Dioxane in Drinking Water by Gas Chromatography/Mass Spectrometry (GC/MS) with Selected Ion Monitoring (SIM)

Mark Belmont, David Steiniger, Eric Phillips, Sergio Guazzotti, Pat O'Brien, Alexander Semyonov  
Thermo Fisher Scientific, Austin, TX

## Key Words

ISQ Single Quadrupole GC-MS, TRACE GC Ultra, TriPlus RSH autosampler, PTV inlet, Sequential SIM/Full Scan, EPA Method 522, Environmental

## Introduction

1,4-Dioxane is used mainly as a stabilizer for 1,1,1-trichloroethane for transport in aluminum containers. It is an irritant to eyes and respiratory system and suspected of causing damage to nervous system, liver, and kidneys.<sup>1</sup> In 2008, testing sponsored by the U.S. Organic Consumers Association found dioxane in almost half of tested organic personal-care products.<sup>1</sup> Of the total 1.163 million pounds of 1,4-dioxane released into the U.S. environment in 1992, as reported to the Toxics Release Inventory, 680 thousand pounds (58.5%) were released into the atmosphere, 450 thousand pounds (38.7%) were released into surface waters, and 33 hundred pounds (2.8%) were released onto the land (TRI92 1994).<sup>2</sup> In 2005, the New Hampshire Department of Environmental Services Waste Management Division started enforcement of an Ambient Groundwater Quality Standard reporting limit of 3 µg/L and trending towards a detection limit of 0.25 µg/L. 1,4-Dioxane has been detected in drinking water in the U.S. at a concentration of 1 µg/L. This application highlights the use of SIM/Full Scan to identify unknowns with a NIST library, while producing accurate results that meet EPA Method 522 requirements.

## Experimental Conditions

Data was collected using a Thermo Scientific ISQ single quadrupole mass spectrometer utilizing the Thermo Scientific TriPlus RSH autosampler and a PTV inlet (CT-Splitless mode) on a Thermo Scientific TRACE GC Ultra gas chromatograph. The mass spectrometry data was collected in Full Scan (FS), selected ion monitoring (SIM), and SIM/Scan modes. A Thermo Scientific TraceGOLD TG-624 column (30 m × 0.25 mm ID, 1.4 µm film thickness; p/n 26085-3320) was used with a Siltek® deactivated baffle liner (p/n 453T2120). Table 1 lists the GC parameters. The ion source temperature of the mass spectrometer was set to 230 °C. The instrument was tuned to meet the bromofluorobenzene (BFB) criteria for this method. See Figure 1.

1,4-Dioxane calibration standards were prepared in dichloromethane as per the method to provide a range from 0.05 ppb to 40 ppb of dioxane.



Table 1. GC parameters

GC Oven Ramp		
Ramp	Temp	Hold
	30 °C	1 min
7 °C/min	90 °C	0 min
20 °C/min	200 °C	3 min
PTV Inlet		
Temperature	200 °C	
Split Flow	30 mL/min	
Splitless Time	0.50 min	
Solvent Valve Temp	100 °C	

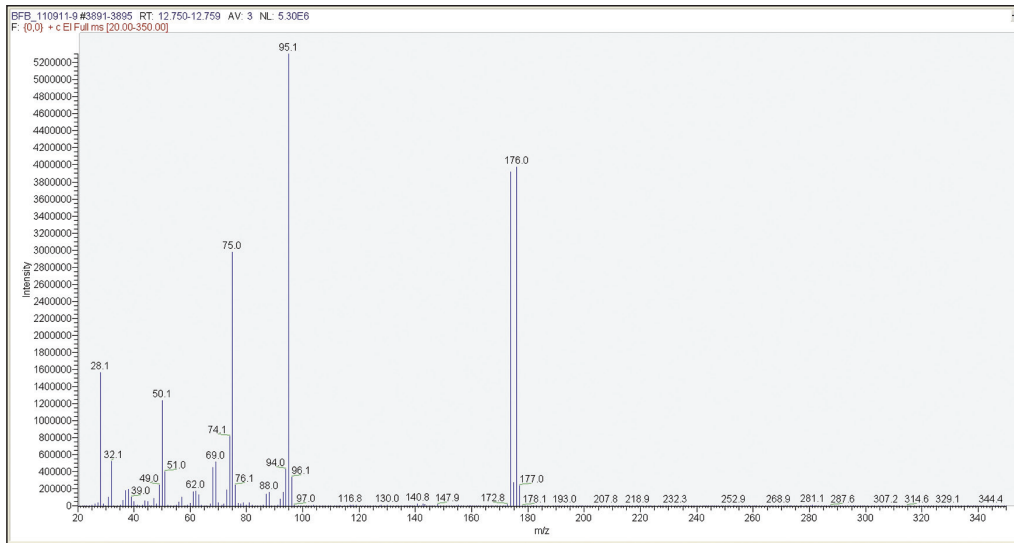

m/z	Criteria	Ion Intensity	TIC %	Criteria %	Pass/Fail
50	15%-40% of mass 95	871150	23.88	23.88	Pass
75	30%-80% of mass 95	1759792	48.25	48.25	Pass
95	Base peak	3647589	100.00	100.00	Pass
96	5%-9% of mass 95	240562	6.60	6.60	Pass
173	<2% of mass 174	21386	0.59	0.71	Pass
174	>50% of mass 174	2993264	82.06	82.06	Pass
175	5%-9% of mass 174	206831	5.67	6.91	Pass
176	>95% but <101% of mass 174	3003238	82.33	100.33	Pass
177	5%-9% of mass 176	173848	4.77	5.79	Pass

Figure 1. BFB and EPA Method 522 criteria

## Full Scan Results

A calibration curve was created in Full Scan mode from 0.05 to 40 ppb of 1,4-dioxane. Figure 2 demonstrates the peak shape and S/N ratio at 0.1 ppb. The Full Scan calibration curve with an  $R^2$  value of 0.9998 is presented in Figure 3.

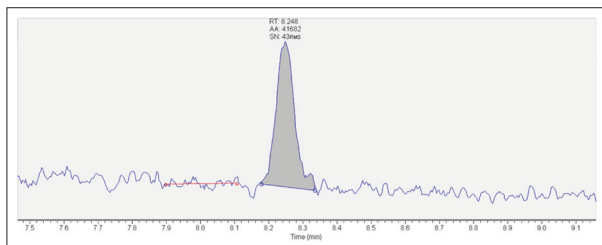

Figure 2. 1,4-Dioxane at a concentration of 0.1 ppb with S/N = 43 in Full Scan

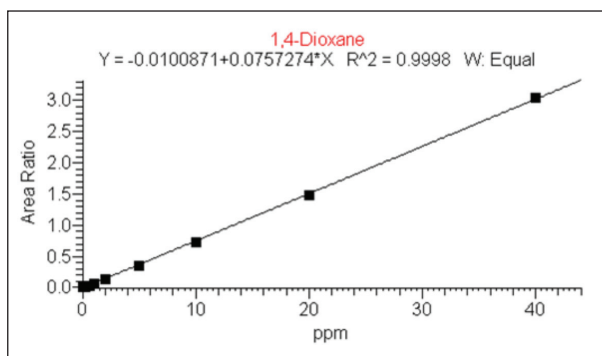

Figure 3. Full Scan calibration curve 0.05 to 40 ppb of 1,4-dioxane

## SIM Results

A calibration curve was created in SIM mode from 0.05 to 40 ppb of 1,4-dioxane by monitoring three ions for the internal standard (46, 78, and 80), three ions for the surrogate (62, 64, 96), and two for the target compound (58, 88). Figure 4 shows the resulting calibration curve with an  $R^2$  value of 0.9998. The chromatogram of the 0.05 ppb standard is depicted in Figure 5. At half the concentration of the full scan the S/N ratio is twice as high, highlighting the power of selected ion monitoring.

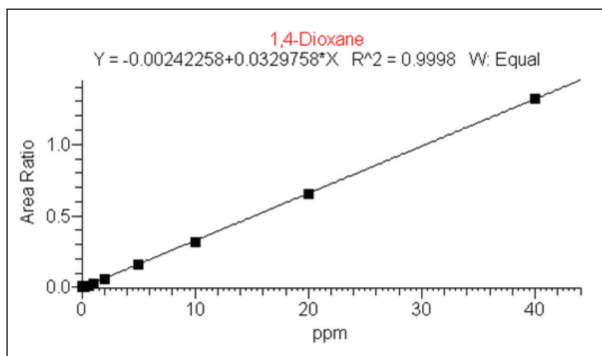

Figure 4. SIM mode calibration curve 0.05 to 40 ppb of 1,4-dioxane

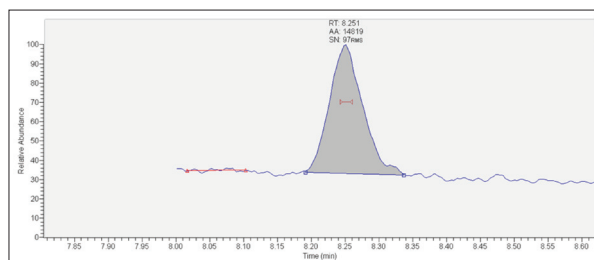

Figure 5. SIM analysis of 1,4-dioxane at 0.05 ppb with S/N = 97. Note the two-fold improvement in the S/N ratio in the SIM mode at one-half the concentration of 1,4-dioxane shown in the full scan in Figure 2.

## Sequential SIM/Full Scan

The advantage of the SIM/Full Scan mode (tandem Full Scan/SIM) is the ability to identify additional peaks in unknown samples using a NIST or other library. Figure 6 provides the setup parameters for the SIM/Full Scan method in the software. Each scan segment contains both the SIM ions and scanning from 45 to 450 amu (Full Scan). SIM and the Full Scan alternate during the data collection. This is visualized in Figure 7, where the shorter scans are the SIM scans and the taller scans are the Full Scans. 1,4-Dioxane standards were analyzed from 0.05 to 40 ppb (Figure 8). According to EPA Method 522, each point on the curve must be within  $\pm 20\%$  of the true value, except the lowest point on the curve, which must be within  $\pm 40\%$ .<sup>3</sup> Even though the calibration curve is linear ( $R^2 = 0.9999$ ), the curve only meets this criteria down to 0.5 ppb. By weighting the curve  $1/x$ , the curve meets the criteria down to 0.05 ppb (Figure 9). Weighting the curve  $1/x$  places more importance on the lower concentrations and has less influence in skewing the results, providing better accuracy at lower levels.

Time (min)	Mass List or Range (amu)	Dwell or Scan Times (sec)	Tune File Name
5.00	20-350	0.096	(Last Saved)
	46, 78, 80	0.03, 0.03, 0...	(Last Saved)
8.00	20-350	0.096	(Last Saved)
	58, 88, 62, 64, 96	0.03, 0.03, 0...	(Last Saved)

Figure 6. MS Method Parameters page from software showing SIM/Full Scan. Note that each segment can have its own specific tune file.

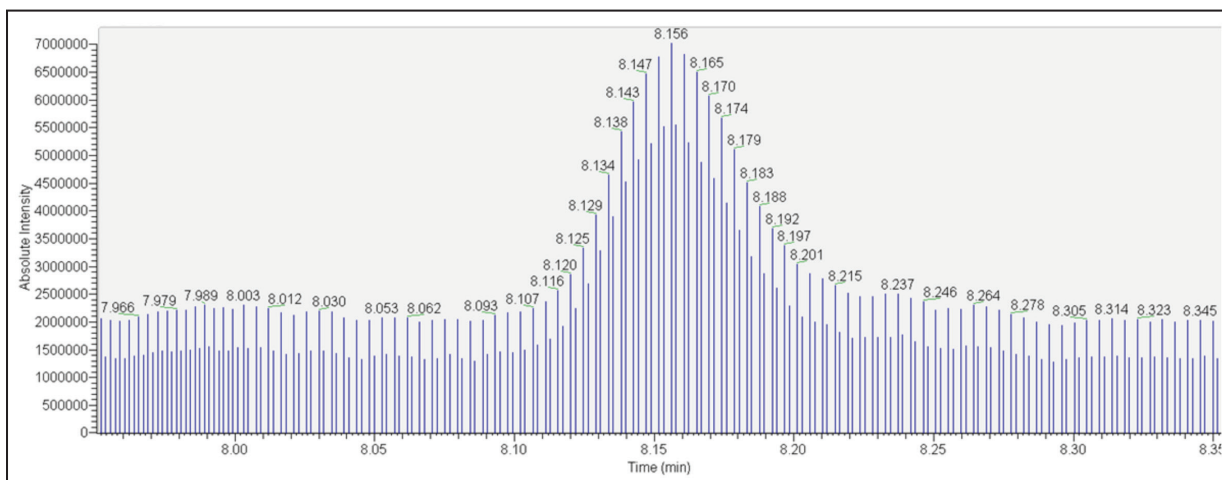

Figure 7. Chromatogram demonstrating the alternating SIM/Full Scan mode of data collection

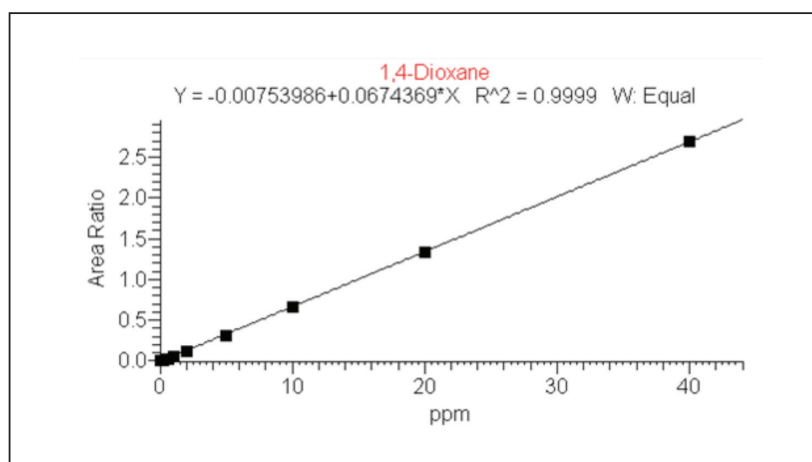

Figure 8. Sequential SIM/Full Scan calibration curve 0.05 to 40 ppb of dioxane

Specified Amount	Calculated Amount	Specified Amount	Calculated Amount
0.050	0.157	0.050	0.061
0.070	0.176	0.070	0.081
0.100	0.199	0.100	0.103
0.200	0.287	0.200	0.193
0.500	0.514	0.500	0.423
1.000	0.980	1.000	0.896
2.000	1.940	2.000	1.869
5.000	4.757	5.000	4.724
10.000	9.840	10.000	9.877
20.000	19.997	20.000	20.172
40.000	40.074	40.000	40.523

Figure 9. Equal weighting (left) vs. 1/x weighting (right) results for calibration curves. 1/x weighting provides better accuracy at lower concentrations

## Comparison

Figure 10 is a comparison of the peak shape of 0.05 ppb in Full Scan, SIM and sequential SIM/Full Scan modes. No loss of precision or accuracy results from using SIM/Full Scan vs. SIM alone. However, by using the SIM/Full Scan mode additional compounds can be identified using a NIST or other library.

Reproducibility of the SIM/Full Scan mode was tested by injecting seven replicates from the same vial at concentrations of 0.07 and 2.0 ppb. The results are reported in Figure 11.

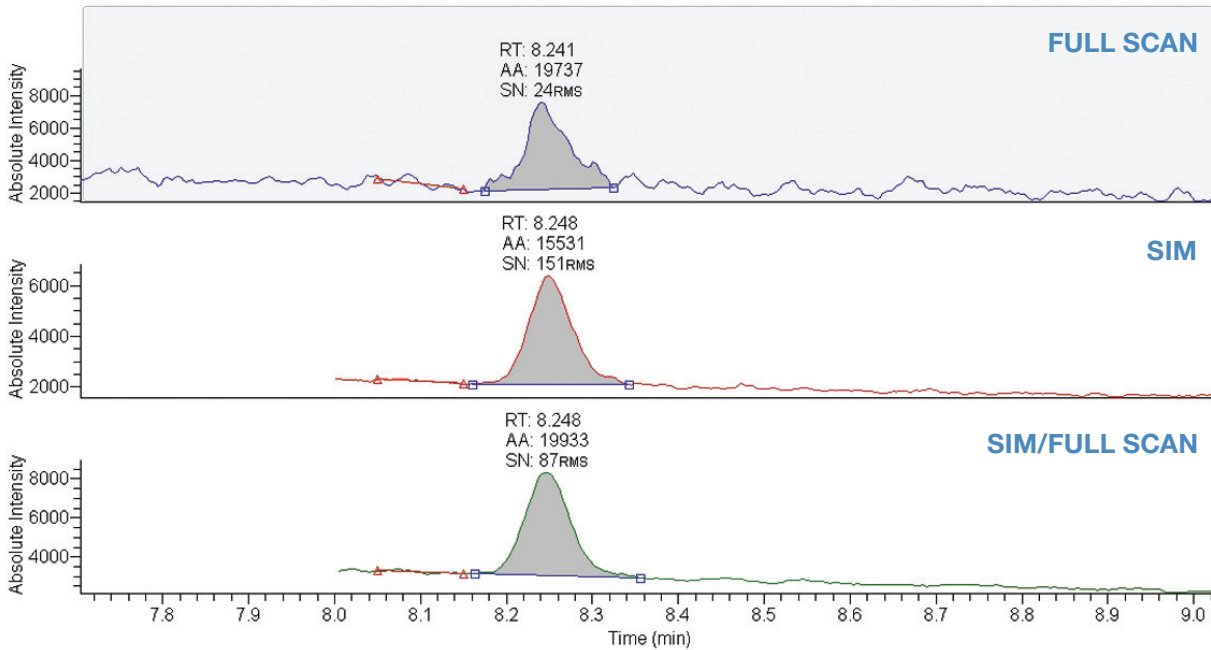

Figure 10. 0.05 ppb of 1,4-dioxane in Full Scan (S/N = 24), SIM (S/N = 151), and SIM/Full Scan (S/N = 87) modes

Sample Name	Area	ISTD Area	Area Ratio	Amount	RT
70ppt_Rep_2	28,335	14,060,852	0.002	0.069	8.236
70ppt_Rep_3	34,444	14,363,502	0.002	0.081	8.243
70ppt_Rep_4	31,241	13,625,849	0.002	0.078	8.234
70ppt_Rep_5	27,271	14,377,709	0.002	0.066	8.235
70ppt_Rep_6	31,189	14,662,503	0.002	0.073	8.234
70ppt_Rep_7	32,470	15,052,986	0.002	0.074	8.244
70ppt_Rep_8	38,823	15,153,194	0.003	0.086	8.240
<i>Avg</i>	<i>31,967</i>	<i>14,470,942</i>	<i>0.002</i>	<i>0.075</i>	<i>8.238</i>
<i>StDev</i>	<i>3,868</i>	<i>539,063</i>	<i>0.000</i>	<i>0.007</i>	<i>0.004</i>
<i>%RSD</i>	<i>12.10</i>	<i>3.73</i>	<i>10.33</i>	<i>9.13</i>	<i>0.05</i>

Sample Name	Area	ISTD Area	Area Ratio	Amount	RT
2ppm_Rep_2	823,612	15,064,599	0.055	1.655	8.238
2ppm_Rep_3	843,990	15,169,091	0.056	1.684	8.235
2ppm_Rep_4	857,227	15,163,169	0.057	1.711	8.231
2ppm_Rep_5	866,259	15,280,099	0.057	1.715	8.227
2ppm_Rep_6	822,302	14,467,495	0.057	1.720	8.239
2ppm_Rep_7	858,037	14,998,817	0.057	1.731	8.246
2ppm_Rep_8	839,242	14,638,036	0.057	1.735	8.236
<i>Avg</i>	<i>844,381</i>	<i>14,968,758</i>	<i>0.056</i>	<i>1.707</i>	<i>8.236</i>
<i>StDev</i>	<i>17,202</i>	<i>301,550</i>	<i>0.001</i>	<i>0.029</i>	<i>0.006</i>
<i>%RSD</i>	<i>2.04</i>	<i>2.01</i>	<i>1.68</i>	<i>1.67</i>	<i>0.07</i>

Figure 11. Precision in SIM/Full Scan mode at 0.07 and 2.0 ppb

## Conclusion

The ISQ™ single quadrupole GC-MS system utilizing the TriPlus™ RSH autosampler and a PTV inlet (CT-Splitless mode) demonstrated its capability to analyze 1,4-dioxane according to EPA Method 522. It easily met the criteria for tuning with BFB and for calibration down to a level of 0.05 ppb. For better accuracy at the lower end of the curve, 1/x weighting was used to meet all of the criteria of the initial calibration of EPA Method 522. SIM analysis gave excellent results at low concentrations. The added advantage of the SIM/Full Scan mode is the ability to identify unknowns with a NIST or other library, while producing accurate results for 1,4-dioxane.

## References

- 1) International Chemical Safety Card: 1,4-Dioxane. National Institute for Occupational Safety and Health. <http://www.cdc.gov/niosh/ipcsneng/neng0041.html>. Retrieved 15 May 2012.
- 2) <http://www.organicconsumers.org/bodycare/DioxaneRelease08.cfm>
- 3) “1, 4-Dioxane Fact Sheet: Support Document”. OPPT Chemical Fact Sheets. United States Environmental Protection Agency. February 1995.
- 4) EPA/600/R-08/101, Method 522 Determination of 1,4-Dioxane in Drinking Water by Solid Phase Extraction (SPE) and Gas Chromatography/Mass Spectrometry (GC/MS) with Selected Ion Monitoring (SIM), Version 1.0, September, 2008, Jean W. Munch and Paul E. Grimmett.

## [www.thermofisher.com](http://www.thermofisher.com)

©2016 Thermo Fisher Scientific Inc. All rights reserved. Siltek is a registered trademark of SilcoTek Corporation. All other trademarks are the property of Thermo Fisher Scientific Inc. and its subsidiaries. This information is presented as an example of the capabilities of Thermo Fisher Scientific Inc. products. It is not intended to encourage use of these products in any manners that might infringe the intellectual property rights of others. Specifications, terms and pricing are subject to change. Not all products are available in all countries. Please consult your local sales representative for details.

<b>Africa-Other</b> +27 11 570 1840	<b>Europe-Other</b> +43 1 333 50 34 0	<b>Japan</b> +81 45 453 9100	<b>Spain</b> +34 914 845 965
<b>Australia</b> +61 3 9757 4300	<b>Finland/Norway/Sweden</b> +46 8 556 468 00	<b>Latin America</b> +1 561 688 8700	<b>Switzerland</b> +41 61 716 77 00
<b>Austria</b> +43 1 333 50 34 0	<b>France</b> +33 1 60 92 48 00	<b>Middle East</b> +43 1 333 50 34 0	<b>UK</b> +44 1442 233555
<b>Belgium</b> +32 53 73 42 41	<b>Germany</b> +49 6103 408 1014	<b>Netherlands</b> +31 76 579 55 55	<b>USA</b> +1 800 532 4752
<b>Canada</b> +1 800 530 8447	<b>India</b> +91 22 6742 9434	<b>New Zealand</b> +64 9 980 6700	
<b>China</b> +86 10 8419 3588	<b>Italy</b> +39 02 950 591	<b>Russia/CIS</b> +43 1 333 50 34 0	
<b>Denmark</b> +45 70 23 62 60		<b>South Africa</b> +27 11 570 1840	

AN52295\_E 08/16C

**Thermo**  
SCIENTIFIC

Part of Thermo Fisher Scientific







# Surface, Drinking and Waste Water Analysis

Speciation Analysis

# Speciation analysis of Cr (III) and Cr (VI) in drinking waters using anion exchange chromatography coupled to the Thermo Scientific iCAP Q ICP-MS

Daniel Kutscher, Shona McSheehy, Julian Wills, Thermo Fisher Scientific, Germany, Detlef Jensen, Thermo Fisher Scientific, Switzerland

## Key Words

iCAP Q, Cr speciation, Ion chromatography, Drinking water, ICS-5000

## Goal

To develop a sensitive, robust and high throughput method for the trace level analysis of Cr (III) and Cr (VI) species in natural waters using IC-ICP-MS.

## Introduction

Due to its widespread use in industrial applications such as chromium plating, dye manufacturing and preservation of wood and leather materials, chromium concentrations in environmental samples are monitored on a routine basis. Both the United States EPA and the European Union have specified maximum admissible chromium concentrations in their respective drinking water directives. As with many other trace elements, chromium (Cr) is typically found in more than one chemical form, each of which with different chemical properties and behavior, such as bioavailability and toxicity. For chromium, Cr (III) is essential to human beings and involved in different processes in the body while Cr (VI) is highly toxic. Total Cr content therefore in, for example, a drinking water sample does not provide sufficient information to evaluate potential hazards to populations exposed to it. In order to provide this critical information a supporting speciation analysis is required to determine the amounts of the different Cr species in the sample. The speciation analysis of Cr however is a challenging task, since the stability of different Cr species is easily affected by conditions during sample collection and treatment<sup>1</sup>. For example, low pH values may lead to the degradation of Cr (VI) to Cr (III) due to the increased redox potential, while high pH values may lead to the precipitation of Cr (III) as  $\text{Cr}(\text{OH})_3$ <sup>2</sup>. An additional difficulty in the accurate speciation analysis of Cr by ICP-MS are the numerous spectral interferences (e.g.  $^{35}\text{Cl}^{16}\text{O}^1\text{H}^+$  or  $^{40}\text{Ar}^{12}\text{C}^+$ ) on the most abundant chromium isotope,  $^{52}\text{Cr}$ .

## Sample and calibration solution preparation

Daily working standards were prepared by diluting the appropriate quantity of commercially available stock solutions (1000  $\mu\text{g}/\text{mL}$ ) of each chromium standard in a 0.1 mol/L ammonium nitrate solution adjusted to a pH of 4. Drinking water was collected in a PFA bottle previously rinsed with high purity nitric acid. The water was analyzed directly without dilution or pH adjustment in order to keep the species unchanged before analysis.

## Instrument configuration

Chromatographic separations were carried out using the Thermo Scientific Dionex ICS-5000 ion chromatography system. Due to its completely metal-free solvent pathway, this system is non-contaminating and is therefore perfectly suited for elemental speciation studies at the trace levels required by this application. For the separation of the two Cr species, a Thermo Scientific Dionex AG-7 anion exchange column (2 x 50mm) was used throughout this study. Although this column is designed to be used as a guard column, its highly effective separation medium contains capacities for the separation of both cationic and anionic species<sup>3</sup> and it is therefore able to completely separate both Cr species in less than three minutes. A Thermo Scientific iCAP Qc ICP-MS was used as a high performing elemental detector of the Cr species eluted from the ICS-5000. Due to the use of flatpole technology in the Thermo Scientific QCell collision cell, the iCAP Q series of ICP-MS instruments offer the selectivity to suppress spectral interferences while maintaining the high sensitivity for trace metal detection in coupled applications such as IC-ICP-MS.



**Thermo**  
SCIENTIFIC

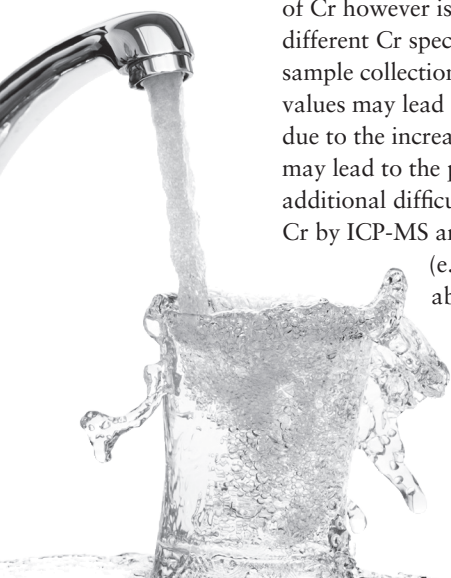

## General analytical conditions

The iCAP Qc ICP-MS was equipped with a peltier cooled PFA spray chamber and a PFA-LC nebulizer (Elemental Scientific, Omaha, NE, USA). The PFA-LC nebulizer has a very low dead volume and is compatible with LC fittings making it ideal for chromatographic analyses. The demountable torch was equipped with a 2 mm I.D. injector. For interference-free detection of  $^{52}\text{Cr}^+$  and  $^{53}\text{Cr}^+$ , all measurements were carried out in a single collision cell mode, with kinetic energy discrimination (KED), using pure He as collision gas.

The instrument was operated using the following parameters:

Parameter	Value
Forward power	1550 W
Nebulizer gas	0.80 L/min
Injector	2 mm I.D.
Cell gas flow / KED voltage	4.8 mL/min He / 2V
Dwell time	100 ms

Table 1: iCAP Q operating parameters.

Chromatographic separations on the ICS-5000 were carried out using the parameters summarized in Table 2. For the elution of the different Cr species, anion exchange chromatography was chosen using isocratic elution with nitric acid. Although the two species have different charges, (Cr (III) is present predominantly as  $[\text{Cr}(\text{H}_2\text{O})_6]^{3+}$  and Cr (VI) as  $\text{H}_2\text{CrO}_4$ ,  $\text{HCrO}_4^-$ ,  $\text{CrO}_4^{2-}$  or  $\text{Cr}_2\text{O}_7^{2-}$  depending on the pH), the Dionex AG-7 column can elute both due to its capacities for the separation of both cations and anions<sup>3</sup>. In contrast to other techniques based on reversed phase ion pairing chromatography, no prior incubation with complexing agents such as EDTA is required with the method described. Sample pre-treatment is therefore no longer required, eliminating any possible risk of contamination as well as maximizing sample

throughput. Under the applied conditions, complete separation of Cr (III) and Cr (VI) is accomplished in less than 150 s.

Column	Dionex AG-7 (2 mm i. D., 50 mm length)
Elution	Isocratic
Mobile phase	0.4 mol/L $\text{HNO}_3$
Flow rate	400 $\mu\text{L}/\text{min}$
Injection volume	20 $\mu\text{L}$
Duration	150 s

Table 2: ICS-5000 operating parameters

Coupling between instruments was achieved by direct connection of the column outlet to the nebulizer. Bi-directional communication was established by using a trigger cable that attached to the I/O panel next to the iCAP Q's sample introduction system. All quantification (evaluation of peak areas and concentrations etc) were achieved using the tQuant features of the Thermo Scientific Qtegra control software.

## Results and Discussion

For initial method development, a mixture containing 5 ng/g of each Cr species was separated using different mobile phases. The resulting chromatograms are shown in Figure 1 as screenshots from the Qtegra™ software package. While the Cr (VI) was easily eluted from the column with all the mobile phases tested, Cr (III) was strongly retained and only eluted as a distinguishable peak at nitric acid concentrations higher than 0.3 mol/L. At even higher concentrations, however, the redox potential of Cr (VI) is increased and could potentially lead to its reduction and therefore possible loss. For this reason, a compromise nitric acid concentration limited to 0.4 mol/L was used for the elution of both Cr species in this study. At this concentration, cycle times of under 150 s were achieved for a complete separation of Cr (III) and Cr (VI).

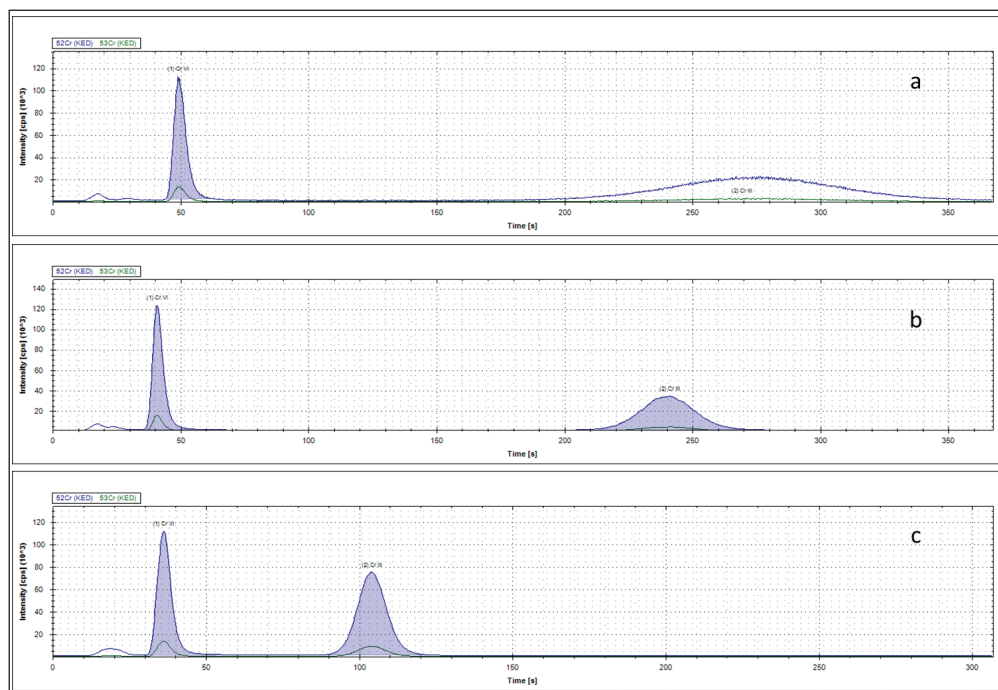

Fig. 1: Cr (III) and Cr (VI) chromatograms obtained using 0.2 (a), 0.3 (b) and 0.4 (c) mol/L nitric acid as mobile phase. Please note that the x-axis in (c) has been shortened to 300 s.

In order to determine the effect of any degradation of Cr (VI) to Cr (III) at these conditions, a linear calibration between 0.75 ng/g and 15 ng/g of each species was performed. The resulting calibration curves are shown in Figure 2. As can be seen, the detection sensitivity was determined to be 220 kcps / ng/g for both species, showing them to be unaffected by the HNO<sub>3</sub> matrix used. Detection limits (LOD) of 0.20 pg/g for Cr (VI) and 0.38 pg/g for Cr (III) were calculated from these calibrations.

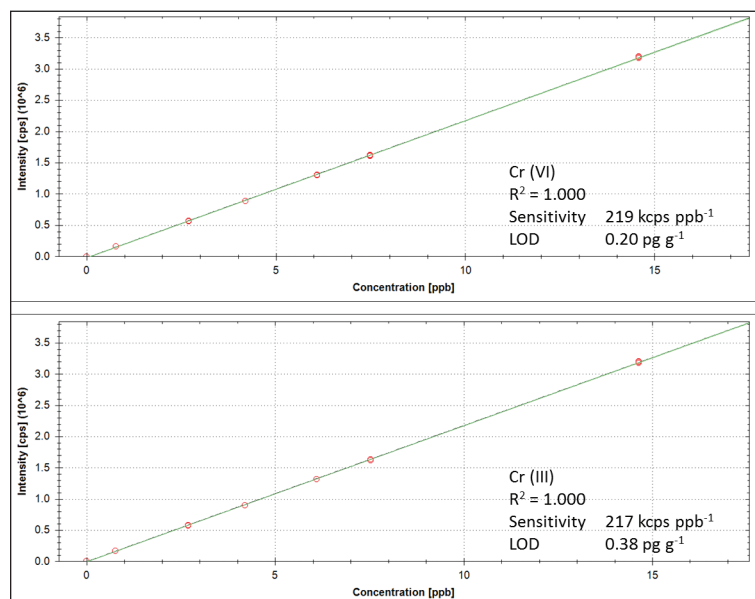

Figure 2: Calibration graphs for Cr (VI) and Cr (III).

As additional proof of the effectiveness of the proposed chromatographic separation, mixtures of both species were quantified against these calibrations in a spike recovery test. Each sample was analyzed in triplicate. The results obtained are shown in Table 3:

Conc. spiked [ng/g]	Cr (VI)		Cr (III)	
	Found (ng/g)	Recovery (%)	Found (ng/g)	Recovery (%)
2.34 of each	2.31 ± 0.01	99 ± 1	2.35 ± 0.02	100 ± 1
6.03 Cr (VI); 1.90 Cr (III)	6.01 ± 0.02	100 ± 1	2.00 ± 0.01	105 ± 1
1.87 Cr (VI); 6.20 Cr (III)	1.85 ± 0.01	99 ± 1	6.15 ± 0.03	99 ± 1

Table 3: Recovery of Cr (VI) and (III) species

These values indicate that recovery for both species is quantitative and therefore both species reach the plasma in their original chemical form. Furthermore, the achieved precisions indicate the excellent stability of the chromatographic separation.

In a second experiment, the reproducibility of the method was investigated. For routine analysis, retention times and peak areas should remain constant to avoid repeated calibration blocks. To test this, a mixture of both species with a concentration of 5 ng/g was repeatedly injected into the LC system over 2.5 h (20 individual injections). Stabilities of < 1.5 % for retention time and < 0.3 % for peak area were obtained (Figure 3).

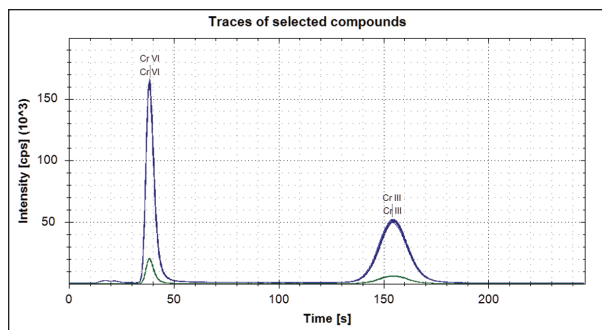

Figure 3: Overlay of 20 repeated injections of Cr (VI) and Cr (III)

### Quantification of Cr (III) and Cr (VI) in tap water

Potable water was collected locally and analyzed using the proposed method. As can be seen from the chromatogram in Figure 4, only trace amounts of Cr (VI), at a retention time of ~40 s, could be detected in this sample. After external calibration, the amount of Cr (VI) observed was found to be  $42.5 \pm 1$  pg/g. As an additional proof that the detected peak corresponds to Cr and is not affected by possibly co-eluting compounds causing spectral interferences (e.g. chlorine or carbon based polyatomic species), the isotope ratio  $^{52}\text{Cr}^+ / ^{53}\text{Cr}^+$  was calculated and corresponds well to the theoretical value of 8.81).

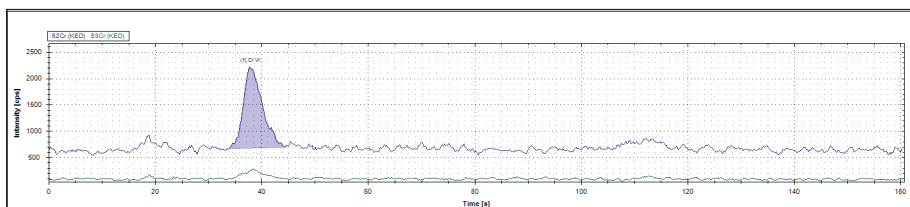

Figure 4:  $^{52}\text{Cr}$  and  $^{53}\text{Cr}$  chromatograms of a locally source potable water.

### Conclusions

Through the combination of the ICS-5000 ion chromatography system with the iCAP Qc ICP-MS, a sensitive, robust method for the speciation analysis of trace levels of Cr (III) and Cr (VI) in natural waters has been developed. The method developed enables fast and reliable speciation analysis of both Cr (III) and Cr (VI) species in water samples without prior incubation steps and with high purity nitric acid as mobile phase. The short, but highly efficient Dionex AG-7 column, provides complete separation of both species in under 150 s, enabling high sample throughput for the routine analysis of water samples.

The new flatpole cell technology introduced in the iCAP Q ICP-MS provides interference-free detection of the  $^{52}\text{Cr}$  and  $^{53}\text{Cr}$  ions. Sub-ppt detection limits are achievable due to the completely metal free pathway of the ICS-5000 and the high instrumental sensitivity offered by the iCAP Q's He KED mode.

### References

- Séby, F., Charles, S., Gagean, M., Garraud, H., Donard, O. F. X., J. Anal. At. Spectrom. 18 (2003), 1386-1390
- Xing, L., Beauchemin, D., J. Anal. At. Spectrom. 25 (2010), 1046-1055
- Dionex homepage (<http://www.dionex.com/en-us/products/columns/ic-rfic/specialty-packed/ionpac-as7/lp-73274.html>)

### Chemicals Used in this Note

Chemical	Fisher Scientific Catalogue Number
IonPac AG-7 Guard Column (2 x 50 mm)	063099
Fisher Optima grade nitric acid	A467-500

For more information please contact your local Fisher Scientific organization and/or visit: [www.fishersci.com](http://www.fishersci.com) or [www.acros.com](http://www.acros.com)

[thermofisher.com](http://thermofisher.com)

© 2016 Thermo Fisher Scientific Inc. All rights reserved. All trademarks are the property of Thermo Fisher Scientific Inc. and its subsidiaries. Specifications, terms and pricing are subject to change. Not all products are available in all countries. Please consult your local sales representative for details.

**Africa-Other** +27 11 570 1840  
**Australia** +61 2 8844 9500  
**Austria** +43 1 333 50 34 0  
**Belgium** +32 53 73 42 41  
**Canada** +1 800 530 8447  
**China** +86 10 8419 3588  
**Denmark** +45 70 23 62 60  
**Europe-Other** +43 1 333 50 34 0

**Finland/Norway/Sweden**  
 +46 8 556 468 00  
**France** +33 1 60 92 48 00  
**Germany** +49 6103 408 1014  
**India** +91 22 6742 9434  
**Italy** +39 02 950 591  
**Japan** +81 45 453 9100  
**Latin America** +1 608 276 5659

**Middle East** +43 1 333 50 34 0  
**Netherlands** +31 76 579 55 55  
**South Africa** +27 11 570 1840  
**Spain** +34 914 845 965  
**Switzerland** +41 61 716 77 00  
**UK** +44 1442 233555  
**USA** +1 800 532 4752

**Thermo**  
 SCIENTIFIC

Part of Thermo Fisher Scientific







## Air and Soil Analysis



# Simultaneous UHPLC/MS Analyses of Explosive Compounds

Guifeng Jiang, Thermo Fisher Scientific, San Jose, CA, USA

## Introduction

Explosive compounds, which are recognized as four major categories, nitroaromatics, nitroamines, nitrate esters and peroxides according to their chemical structures, are widely used in warfare, mining industries, terrorist attacks and civil constructions. Explosive contaminated soils are mostly found on firing points, impact areas and training ranges. Hexahydro-1,3,5-trinitro-1,3,5-triazine (RDX) is a primary explosive found on the training ranges, as well as 2,4,6-trinitrotoluene (TNT), 2,6-dinitrotoluene (2,6-DNT) and 2,4-dinitrotoluene (2,4-DNT). The explosive contaminates in soil are possible sources for surface and ground water contaminations, posing the environmental and public health risks due to the compounds' toxicity, carcinogenicity and mutagenicity.<sup>1,2</sup> The increased terrorism activities have brought the world's attention on explosive compounds, especially peroxide explosives. Triacetone triperoxide (TATP) became a well known peroxide explosive after its use by a terrorist in 2001. The analyses of explosive compounds are demanded by the environmental monitoring and protection agencies, crime scene investigations and homeland securities. Explosive analyses are challenging processes because most of the explosive materials degrade quickly after their explosion and the sample matrices vary from one to the other. Furthermore, the peroxide explosives are not suitable for UV detection because of their lack of chromophores and their instability under the illumination of UV light.

The U.S. Environmental Protection Agency (USEPA) method 8330 is the current standard method for the identification of explosive compounds, which uses HPLC separation and UV detection of nitroaromatic and nitroamine compounds. However, the lack of selectivity of UV detection makes compound identification in complicate matrices ambiguous. Mass spectrometry has been employed in TATP detection with Agilent LC/MSD TOF instrument; however, the Agilent instrument and method demonstrated poor sensitivity with limit of quantitation (LOQ) at 1 mg/L.<sup>3</sup>

In this application, we developed an ultra high performance liquid chromatography/mass spectrometry (UHPLC/MS) method to efficiently separate, detect and quantitate all four classes of explosive compounds, including eight nitroaromatics, two nitroamines, five nitrate esters and two peroxides. The explosives were separated on a Thermo Scientific Hypersil GOLD PFP, 1.9  $\mu\text{m}$ , 2.1 x 100 mm column and detected by selected ion monitoring (SIM) on a Thermo Scientific MSQ Plus Mass Detector – a fast scanning, single-quadrupole mass spectrometer.



## Experimental Conditions

### Standard Preparation

Hexamethylenetriperoxidetriamine (HMTD), octahydro-1,3,5,7-tetranitro-1,3,5,7-tetrazocine (HMX), hexahydro-1,3,5-trinitro-1,3,5-triazine (RDX), ethylene glycol dinitrate (EGDN), diethylene glycol dinitrate (DEGDN), 1,3,5-trinitrobenzene (1,3,5-TNB), 1,3-dinitrobenzene (1,3-DNB), methyl-2,4,6-trinitrophenylnitramine (Tetryl), 4-amino-2,6-dinitrotoluene (4A-DNT), 2-amino-4,6-dinitrotoluene (2A-DNT), nitroglycerin (NG), 2,4,6-trinitrotoluene (TNT), 2,6-dinitrotoluene (2,6-DNT), 2,4-dinitrotoluene (2,4-DNT), pentaerythritol tetranitrate (PETN), trimethylolethane trinitrate (TMETN), and triacetone triperoxide (TATP) were purchased from AccuStandard® (New Heaven, CT, USA) as 100 mg/L standard solution in acetonitrile or in solid form. The stock solutions of 1000 mg/L of RDX, TNT, Tetryl and PETN standard were prepared by dissolving accurately weighed solids in acetonitrile or methanol. The calibration standards were prepared by diluting the 100 mg/L stock solutions with water to 0.010, 0.032, 0.160, 0.800, 4.00, and 20.00 mg/L.

### Sample Preparation

Blank soil sample (San Jose, CA) was dried and homogenized. Each 2.0 g of the dried blank soil sample was amended with 0.04  $\mu\text{L}$ , 0.2  $\mu\text{L}$ , 1  $\mu\text{L}$ , 2  $\mu\text{L}$  and 10  $\mu\text{L}$  standard solution containing 100 mg/L RDX, TNT, Tetryl and PETN, which corresponded to 2, 10, 50, 100 and 500  $\mu\text{g/kg}$  for each analyte in soil. The amended soil samples (2.0 g) were added to 5 mL of acetonitrile. The solutions were capped and sonicated for 15 min. The supernatants (3.5 mL) were transferred to a clean vial, evaporated at 37 °C to dryness under nitrogen. The residues were reconstituted with 200  $\mu\text{L}$  acetonitrile as samples for LC/MS analyses.

## Key Words

- MSQ Plus Mass Detector
- Explosives
- Library Spectra
- Sensitivity
- UHPLC

### Chromatographic Conditions

Instruments:	Thermo Scientific Accela pump Thermo Scientific Accela Autosampler			
Columns:	Hypersil GOLD PFP, 1.9 $\mu$ m, 100 x 2.1 mm			
Flow Rate:	0.5 mL/min			
Mobile Phase:	A: water, 1 mM ammonium formate B: methanol			
Gradients:	Time (min)	A(%)	B(%)	$\mu$ L/min
	0.0	80.0	20.0	500
	10.0	45.0	55.0	500
	12.0	20.0	80.0	500
	12.1	5.0	95.0	500
	12.9	5.0	95.0	500
	13.0	80.0	20.0	500
	15.0	80.0	20.0	500

Injection Volume: 2  $\mu$ L partial loop injection, 25  $\mu$ L loop size

### Mass Spectrometer Conditions

Instrument:	MSQ Plus Mass Detector
Ionization:	Atmospheric Pressure Chemical Ionization (APCI)
Polarity:	Positive and Negative
Probe Temperature:	350 $^{\circ}$ C
Cone Voltage:	60.0 V
Scan Mode:	Full scan with mass range of 50-400 amu or selected ion monitoring (SIM)
Corona Current:	30 $\mu$ A
Scan Time:	0.5 s for full scan, 0.25 s for SIM

## Results and Discussion

### UHPLC Separation and MS Detection

USEPA 8330 method provides sensitive UV detection for nitroaromatic and nitroamine explosives. However, two analytical columns with different stationary phases are required to separate and identify the isomers, 2,4-DNT and 2,6-DNT, 4-A-2,6-DNT and 2-A-4,6-DNT, which make this method time consuming and results in low sample throughput.

The simultaneous separation and detection of seventeen explosive compounds was achieved through UHPLC/MS, using the Thermo Scientific Accela system with a fast scanning, single quadrupole mass spectrometer (Figure 1). Water and methanol were used as the mobile phases and the optimized gradient is shown in the Chromatographic Conditions. The elution order of the compounds and their retention times are shown in Figure 1. Hypersil GOLD™ PFP has a fluorinated phenyl group in the stationary phase which improves selectivity towards aromatic compounds. It also provides better resolutions for polar compounds containing hydroxyl, carboxyl, nitro or other polar groups. Eight nitroaromatic compounds, two nitroamine compounds, five nitrate ester compounds and two peroxides were separated with baseline resolution on a Hypersil GOLD PFP, 1.9  $\mu$ m, 100 x 2.1 mm column. The isomer pairs, 2,4-DNT and 2,6-DNT, 4-A-2,6-DNT and 2-A-4,6-DNT, were separated with the peak resolution of 2.8 and 7.3 respectively (Peaks 9 and 11, 12 and 16).

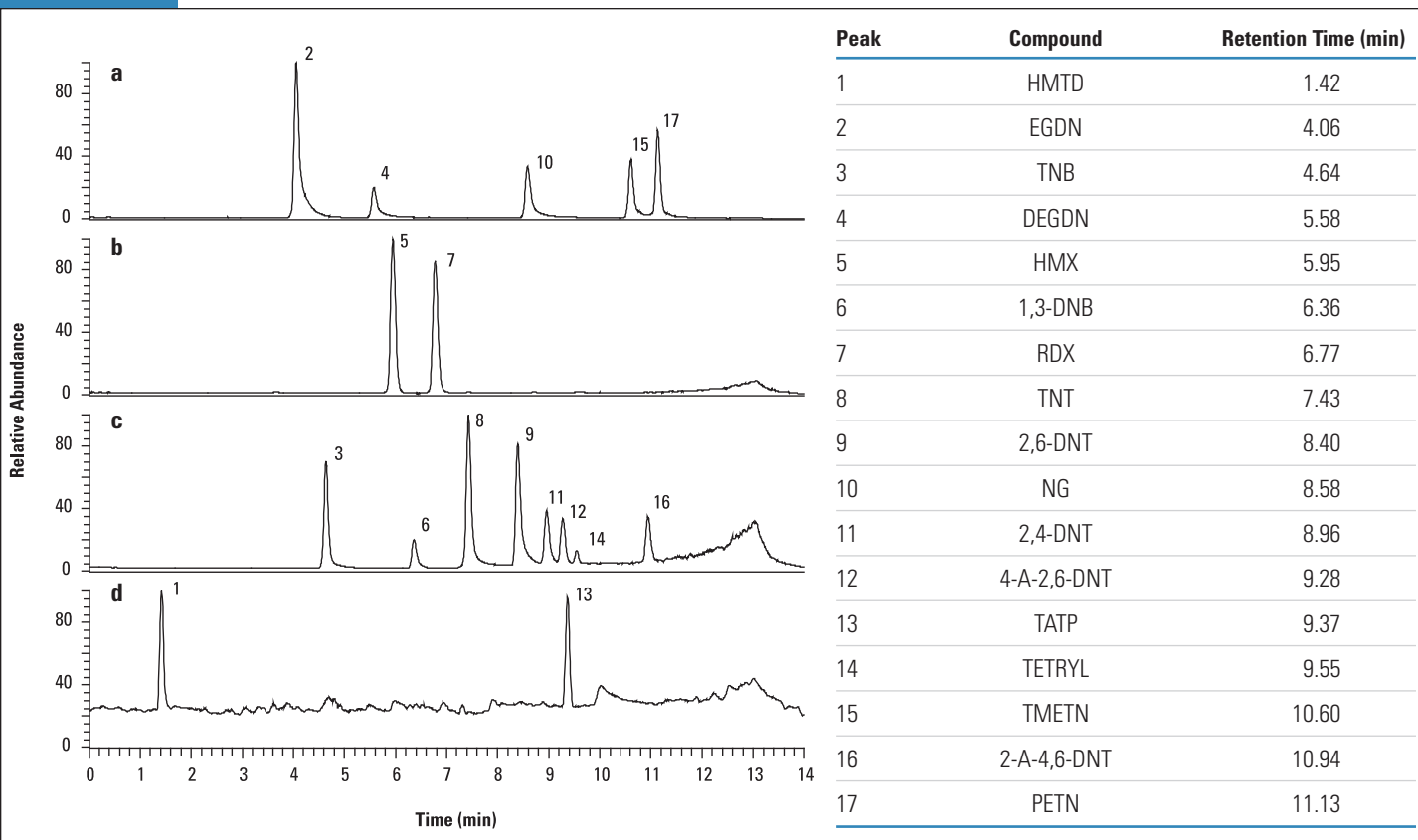

Figure 1: UHPLC/MS separation and detection of the 17 explosives standard with negative APCI (a-c) and positive APCI (d) ionizations. a) Extracted ion chromatogram at  $m/z$  of 61.96; b) Extracted ion chromatogram at  $m/z$  of 102.05; c) Extracted ion chromatogram at  $m/z$  of 213.02, 168.09, 227.01, 182.07, 197.04 and 241.02; d) Extracted ion chromatogram at  $m/z$  of 209.04 and 348.08.

The MSQ™ Plus Mass Detector was employed for the detection of the explosive compounds. Full scan mode with a mass range of 50-400 amu was employed for the compound identification and confirmation, while SIM mode was used for the sensitivity and quantitation studies.

The mass spectra for some explosive compounds are difficult to be predicted because of their reactivity. An array of the ions, such as additive adducts and decomposing ions, is observed in the LC/MS analyses of explosives.<sup>4</sup> The observed ion signals vary depending on many factors, for example, the ionization sources, analytes concentrations, additive concentrations, impurities in the mobile phases and the contaminations of the LC/MS system.

APCI was used in the MS detection of the explosives because it gave better sensitivities than ESI. Nitroaromatics, nitroamines and nitrate esters were detected using APCI negative mode, while peroxides were detected using APCI positive ionization (Figure 2). Some explosive standards, including TNB, 1,3-DNB, TNT, 2,6-DNT, 2,4-DNT, 4-A-2,6-DNT and 2-A-4,6-DNT, showed both molecular ion signals ( $[M]^-$  or  $[M-H]^-$ ) and decomposing ions ( $[M-30]^-$  and/or  $[M-17]^-$ ) in their MS spectra. Other explosive standards showed only decomposing ions: the nitrate esters, including EGDN, DEGDN, NG, TMETN and PETN, showed decomposing ions of  $[\text{NO}_3]^-$  at  $m/z$  61.95; the nitroamines, including RDX and HMX, showed decomposing ions at  $m/z$  102.05 and 129.16. TATP formed adduct ions with its decomposing ions and ammonium,  $[M+\text{NH}_4 + \text{H}(\text{OOC}(\text{CH}_3)_2\text{OOH})^+]$  at  $m/z$  of 348.08. In this case, the addition of 1 mM ammonium acetate in the mobile phase A was critical, providing the sources of ammonium ions to facilitate the formation of the ammonium adduct.

The two isomer pairs, 2,6-DNT and 2,4-DNT, 4-A-2,6-DNT and 2-A-4,6-DNT, demonstrated significant differences in their fragmentation MS spectra with the source induced fragmentation (SID) of the MSQ Plus Mass Detector. The spectrum of the 2,6-DNT showed one major fragmentation ion  $[M-30]^-$  at  $m/z$  152.10, while 2,4-DNT gave two major fragmentation ions  $[M-30]^-$  at  $m/z$  152.11 and  $[M-17]^-$  at  $m/z$  165.15. 4-A-2,6-DNT showed one major fragmentation ion  $[M-30]^-$  at  $m/z$  167.09, while 2-A-4,6-DNT gave two major fragmentation ions  $[M-30]^-$  at  $m/z$  167.10 and  $[M-17]^-$  at  $m/z$  180.16. Thus, the identification of these isomers was strengthened with the single quadrupole MS detector.

The identification of the explosive compounds with EPA 8330 method is based solely on the retention times of LC separations. The interference of the sample matrices alters the retention times of target compounds and causes false identifications. With the current UHPLC/MS method, target compounds are identified and confirmed by matching the APCI mass spectra against the MS spectra library. Figure 3A showed a total ion chromatogram (TIC) of a customer sample collected by this method. TNT and 2,4-DNT were easily identified by library spectra search against more than 20 explosive compounds (Figure 3). The Thermo Scientific Xcalibur software displayed the searching result with a list of compounds ranked by their matching scores. The implementation of the MS spectra library in compound identification provided more confirmative results compared to EPA 8330 method.

### Detection Linearity and Sensitivity

The detection linearity of the UHPLC/MS system was investigated using the explosives standard. Calibration curves of seventeen standards were constructed over a concentration range of 10-100,000 ng/mL (ppb). Correlation coefficients of 0.999 or better were achieved for most of the standards (Table 1). The calibration curves for TNB, TNT, 2,6-DNT, 2,4-DNT and TETRYL showed linearity over four orders of magnitude working ranges (Table 1).

Improved sensitivities were observed by high throughput UHPLC because of the sharper and taller peaks produced by the sub-2  $\mu\text{m}$  particle columns. The SIM mode of the MSQ Plus Mass Detector further extended the detection sensitivity compared to the traditional UV detector. The limit of quantitation (LOQ) and the limit of detection (LOD) for seventeen standard explosive compounds were examined. The sensitivities were achieved at ppb level for TNB, 1,3-DNB, TNT, 2,6-DNT, 2,4-DNT, TATP and TETRYL (Table 1). This represents a thirty-five times improvement in the detection sensitivity for TATP relative to the detection sensitivity of the Agilent instrument and method. The detection sensitivities obtained by the UHPLC/MS method with library matching of APCI mass spectra was more than tenfold versus the EPA 8330 method.



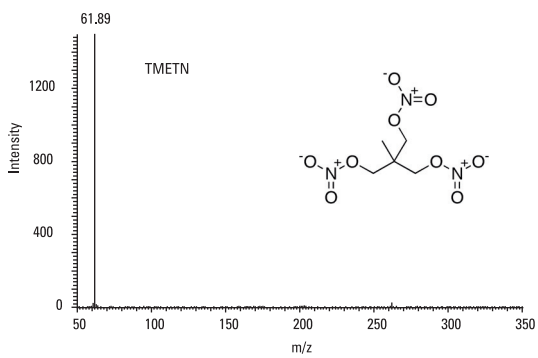
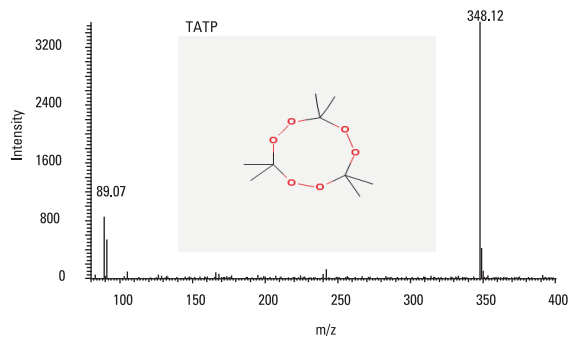
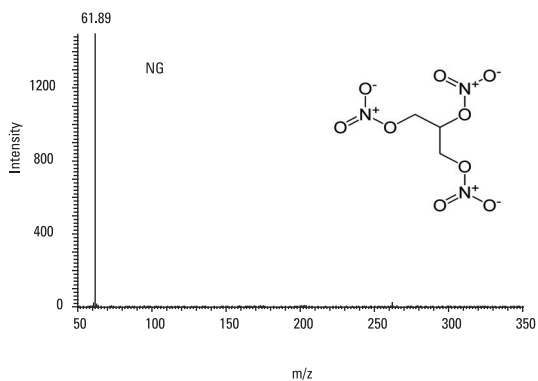
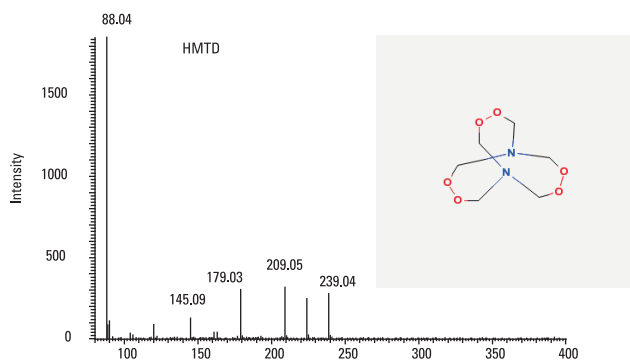
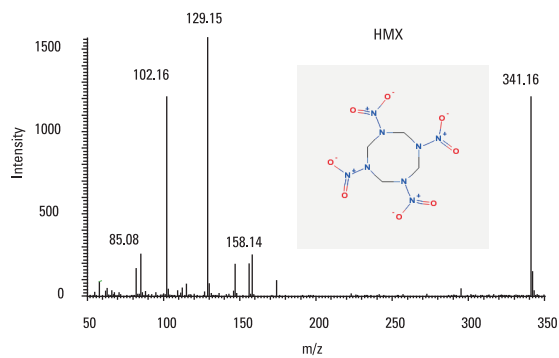
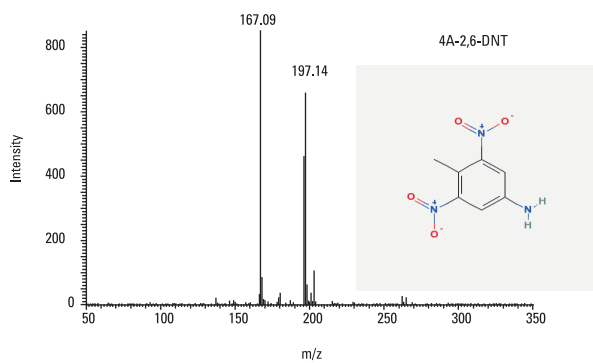
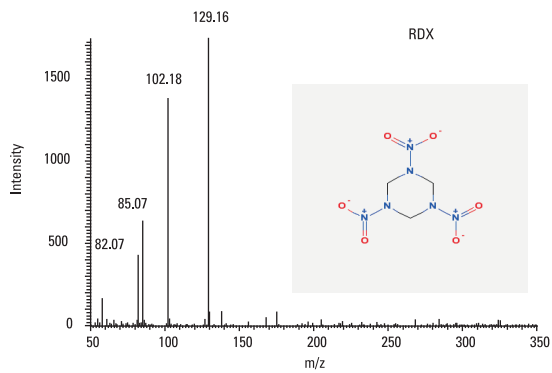
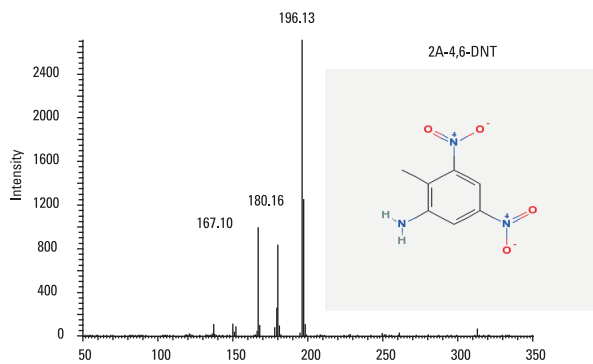

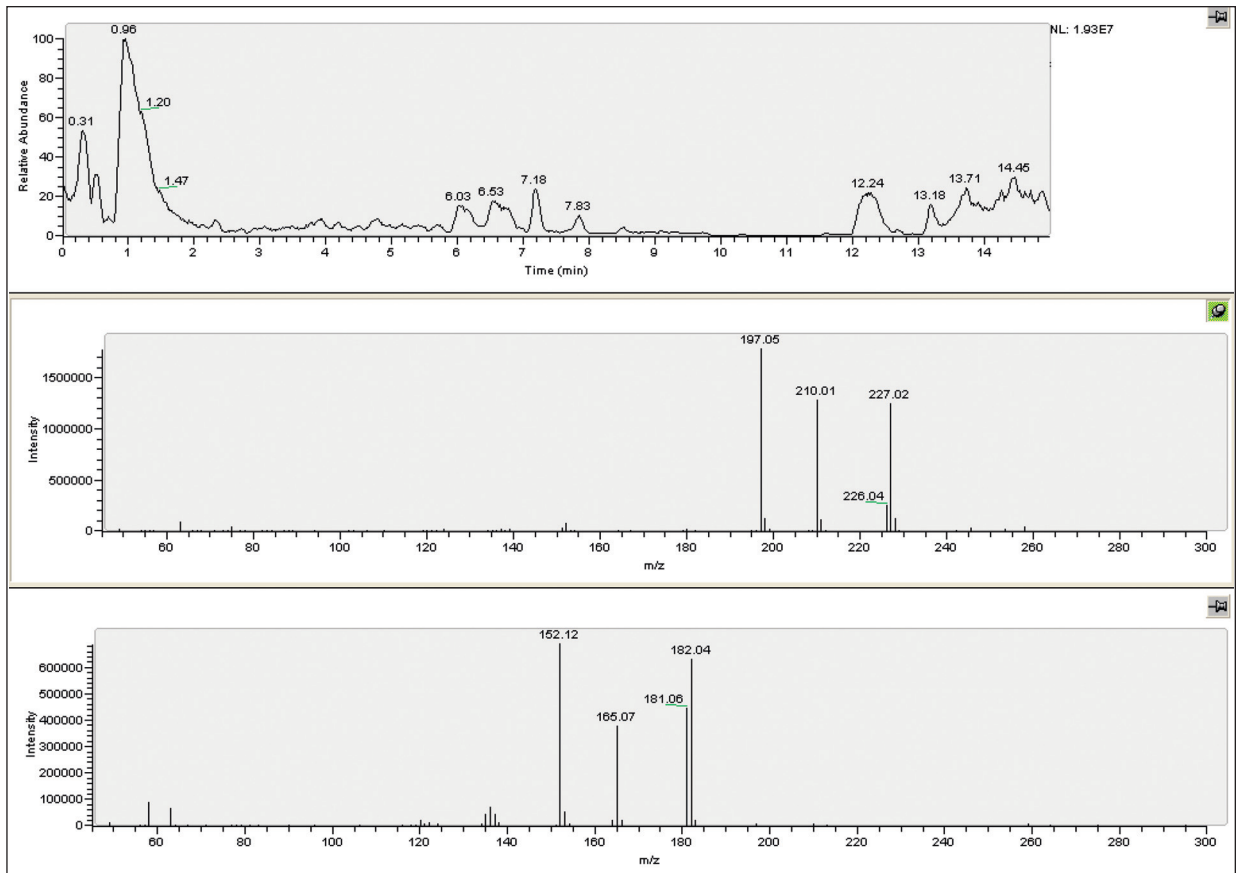

3a

Hit	SI	RSI	Prob	Name	Library Name
1	874	884	98.19	Trinitrotoluene	Explosives-MSQ
2	300	465	0.98	4-amino-2,6-dinitrotoluene	Explosives-MSQ
3	292	411	0.73	2-amino-4,6-dinitrotoluene	Explosives-MSQ
4	184	219	0.04	Tetryl	Explosives-MSQ
5	172	365	0.03	2,4-Dinitrotoluene	Explosives-MSQ
6	132	135	0.00	1,3,5-Trinitrobenzene	Explosives-MSQ
7	99	261	0.00	2,6-Dinitrotoluene	Explosives-MSQ
8	74	78	0.00	Ethylene glycol dinitrate	Explosives-MSQ
9	60	70	0.00	Hexamethylenetriperoxide	Explosives-MSQ
10	1	7	0.00	Trimethylethane trinitrate	Explosives-MSQ

Hit	SI	RSI	Prob	Name	Library Name
1	772	789	98.17	2,4-Dinitrotoluene	Explosives-MSQ
2	556	779	98.17	2,6-Dinitrotoluene	Explosives-MSQ
3	232	587	0.98	2-nitrotoluene	Explosives-MSQ
4	214	244	0.50	Tetryl	Explosives-MSQ
5	186	560	0.14	4-nitrotoluene	Explosives-MSQ
6	178	191	0.10	Trinitrotoluene	Explosives-MSQ
7	160	633	0.05	3-nitrotoluene	Explosives-MSQ
8	136	137	0.01	2-amino-4,6-dinitrotoluene	Explosives-MSQ
9	104	158	0.00	4-amino-2,6-dinitrotoluene	Explosives-MSQ
10	87	98	0.00	1,3,5-Trinitrobenzene	Explosives-MSQ
11	32	56	0.00	hexahydro-1,3,5-trinitro-1,3,5-triazine	Explosives-MSQ
12	7	9	0.00	Hexacetone triperoxide	Explosives-MSQ
13	4	17	0.00	1,2-dinitrobenzene	Explosives-MSQ

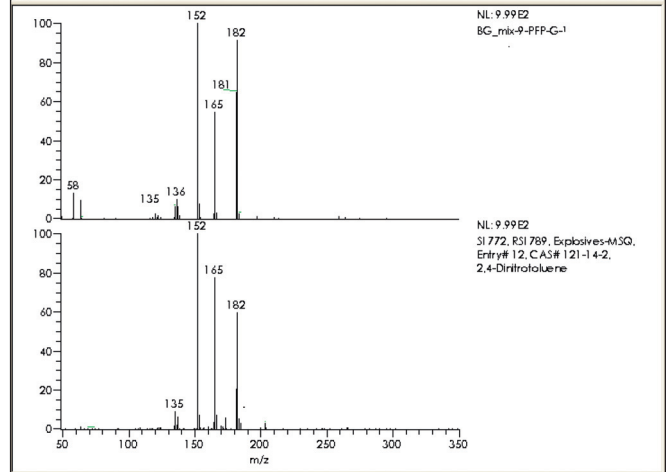
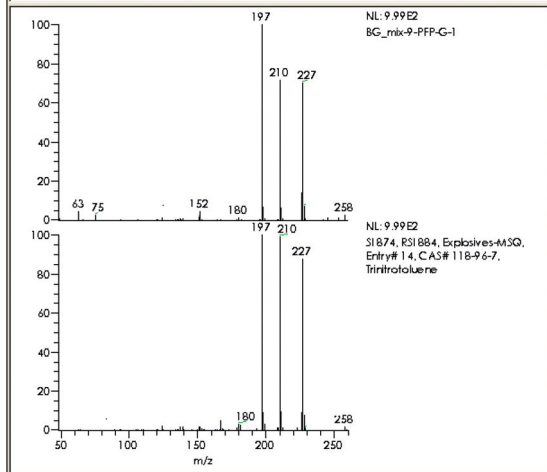

3b

3c

Figure 3: The identifications of the explosives in customer sample using library spectra search: a) Total ion chromatography of the customer sample and the two MS spectra at 7.18 and 7.83 minute, respectively; b) The MS library search result for peak at 7.18 minute; c) The MS library search result for peak at 7.83 minute.



Compound	Monoisotopic Mass	Observed Mass	Linearity Range ng/mL	Correlation Coefficients	LOQ ng/mL	LOD ng/mL
HMTD	208.07	209.04	1000-100,000	0.9915	1136	341
EGDN	152.01	61.96	200-100,000	0.9997	79	24
TNB	213.00	213.00	10-100,000	0.9971	8	2
DEGDN	196.12	61.96	200-100,000	0.9991	617	185
HMX	296.05	102.05	225-100,000	0.9990	55	16
1,3-DNB	168.02	168.09	32-100,000	0.9950	16	5
RDX	222.03	102.05	225-100,000	0.9990	89	27
TNT	227.02	227.01	10-100,000	0.9977	8	2
2,6-DNT	182.03	152.07	10-100,000	0.9996	3	1
TATP	222.11	348.08	100-100,000	0.9964	28	8
NG	227.00	61.95	200-100,000	0.9994	265	79
2,4-DNT	182.03	152.07	10-100,000	0.9995	7	2
4-A-2,6-DNT	197.04	197.04	160-100,000	0.9998	91	27
TETRYL	287.01	241.02	10-100,000	0.9924	10	3
TMETN	255.14	61.95	200-100,000	0.9990	110	33
2-A-4,6-DNT	197.04	196.04	160-100,000	0.9965	75	22
PETN	316.01	61.95	200-100,000	0.9994	76	23

Table 1: LOQ and LOD of seventeen standard compounds

### Analyses of Explosive Compounds in Soil Matrices

The explosive compounds, extracted from soil sample with acetonitrile, were analyzed using the UHPLC/MS method. Figure 4 showed the chromatography traces of RDX, TNT, Tetryl and PETN at 500 µg/kg, 10 µg/kg and the solvent extraction blank. The sample extraction recoveries from the soil matrices were evaluated. Four compounds, RDX, TNT, Tetryl and PETN, were tested at 500 µg/kg and 10 µg/kg levels (Table 2). Greater than 94% extraction recovery at 500 µg/kg level and more than 82% recovery at 10 µg/kg level were achieved for all the compounds tested. The method linearity and sensitivity were investigated for those compounds in soil matrices in the range of 2 to 500 µg/kg. Linear correlation coefficients of 0.996 or better were obtained (Figure 5). LOD of 0.2 to 0.6 µg/kg were achieved for TNT, Tetryl and PETN in soil matrices (Table 3).

Compound	Extraction Recovery %	
	10 µg/kg	500 µg/kg
RDX	89.7	96.2
TNT	92.1	98.5
Tetryl	90.6	95.4
PETN	82.3	94.3

Table 2: Extraction recoveries in soil matrices

	LOQ µg/kg	LOD µg/kg
RDX	16.5	5.0
TNT	0.7	0.2
Tetryl	1.8	0.6
PETN	2.0	0.6

Table 3: The method LOQ and LOD for compounds in soil matrices

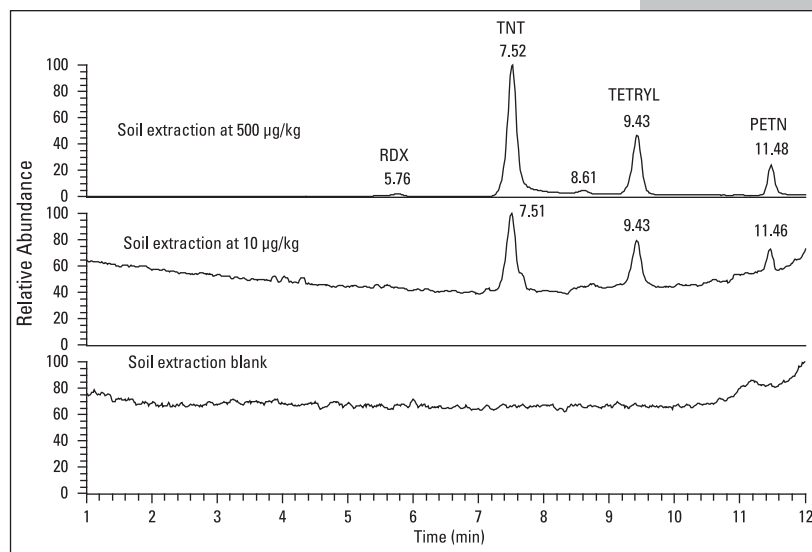

Figure 4: The UHPLC/MS analyses of the explosives in soil matrices



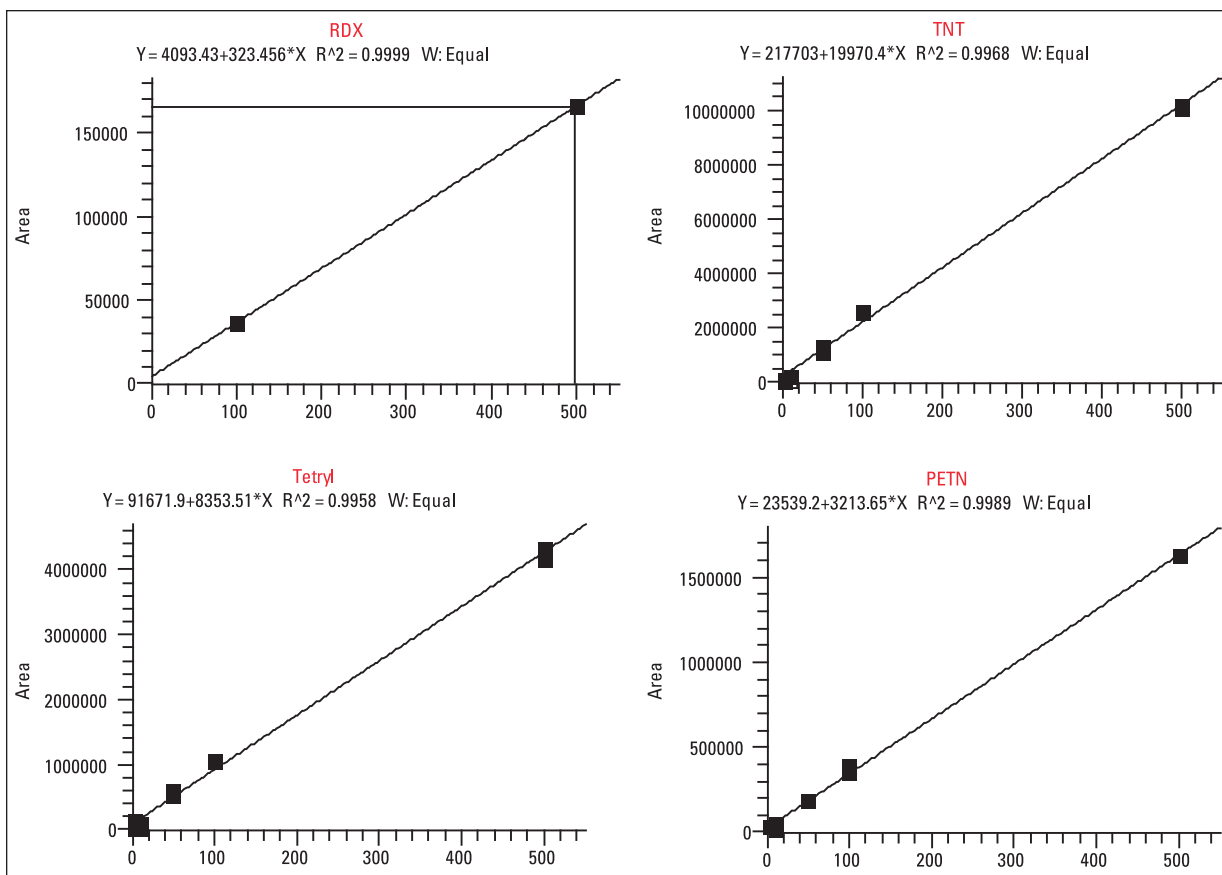

Figure 5: Linearity of the UHPLC/MS method for the analyses of explosives compounds in soil matrices

## Conclusions

The simultaneous analyses of nitroamines, nitroaromatics, nitrate esters, and peroxide explosives by UHPLC/MS were accomplished. The UHPLC method, utilizing sub-2  $\mu\text{m}$  particles, improved the separation efficiencies and resolutions. The MS detection method offered improved sensitivities, good selectivity and additional MS confirmations. The detection sensitivities were further increased by the pre-concentration step implemented in the sample preparation process. The more confirmative identifications of explosives were achieved by comparing of the collected APCI mass spectra to the comprehensive MS spectra library of the explosive residues. We demonstrated the improved separation performance, increased detection sensitivity and better selectivity, compared to the current USEPA 8330 method. We also achieved 35 times detection sensitivity for TATP compared to the Agilent instrument and method.

## Legal Notices

©2016 Thermo Fisher Scientific Inc. All rights reserved. AccuStandard is a registered trademark of AccuStandard, Inc. All other trademarks are the property of Thermo Fisher Scientific Inc. and its subsidiaries. This information is presented as an example of the capabilities of Thermo Fisher Scientific Inc. products. It is not intended to encourage use of these products in any manners that might infringe the intellectual property rights of others. Specifications, terms and pricing are subject to change. Not all products are available in all countries. Please consult your local sales representative for details.

## References

1. D.R. Felt, S.L. Larson and L.Escalon, An extraction/concentration procedure for analysis of low-level explosives in soils; *Talanta* 76, (2008) 21-28.
2. R. Tachon, V. pichon, M. B. Le Borgne, J-J. Minet, *J. Chromatogr. A* (2007), doi : 10.1016/j.chroma.2007.03.059
3. Agilent Application : Analysis of Trace Residues of Explosive Materials by Time-of-Flight LC/MS
4. A. Gapeev, M. Sigman and J. Yinon, Liquid chromatography/mass spectrometric analysis of explosives: RDX adduct ions; *Rapid Commun. Mass Spectrum.* 2003;17:943-948

In addition to these offices, Thermo Fisher Scientific maintains a network of representative organizations throughout the world.

**Africa-Other**  
+27 11 570 1840

**Australia**  
+61 2 8844 9500

**Austria**  
+43 1 333 50 34 0

**Belgium**  
+32 53 73 42 41

**Canada**  
+1 800 530 8447

**China**  
+86 10 8419 3588

**Denmark**  
+45 70 23 62 60

**Europe-Other**  
+43 1 333 50 34 0

**Finland/Norway/Sweden**  
+46 8 556 468 00

**France**  
+33 1 60 92 48 00

**Germany**  
+49 6103 408 1014

**India**  
+91 22 6742 9434

**Italy**  
+39 02 950 591

**Japan**  
+81 45 453 9100

**Latin America**  
+1 608 276 5659

**Middle East**  
+43 1 333 50 34 0

**Netherlands**  
+31 76 579 55 55

**South Africa**  
+27 11 570 1840

**Spain**  
+34 914 845 965

**Switzerland**  
+41 61 716 77 00

**UK**  
+44 1442 233555

**USA**  
+1 800 532 4752

[www.thermo.com](http://www.thermo.com)

AN51879\_E 08/16M

# Quantitative Analysis of Environmental Air Contaminants Using APCI-MS/MS in Mobile Laboratories

Germain Tremblay, Lise Blanchard, Dominic Lortie – Ministère du Développement durable, de l'Environnement et des Parcs, Laval, Québec, Canada; Calin G. Znamirovski – Thermo Fisher Scientific, West Palm Beach, Florida, USA

## Introduction

There are many potential hazards in our environment. Chemical emissions, accidental chemical spills and fires are of particular concern. A real-time analytical atmospheric pressure chemical ionization-tandem mass spectrometry (APCI-MS/MS) method for the quantitative analysis of air contaminants has been developed using a customized, direct-sampling APCI device coupled with a Thermo Scientific TSQ series triple stage quadrupole mass spectrometer. This method is critical for both environmental monitoring in areas of steady or long-term exposure and also for accidental or emergency instances. In such situations, timely and accurate qualitative and quantitative information on the types and levels of various toxic chemical contaminants is required to evaluate the hazard and prevent public exposure. Methods have been developed for chemicals related to the ambient air quality criteria, governed by the Ministère du Développement durable, de l'Environnement et des Parcs (MDDEP) of Québec, Canada. Criteria are illustrated in Table 1, for a limited selection of contaminants. A TSQ Series triple stage quadrupole mass spectrometer, with a customized APCI device for direct sampling, has been used (Figure 1).

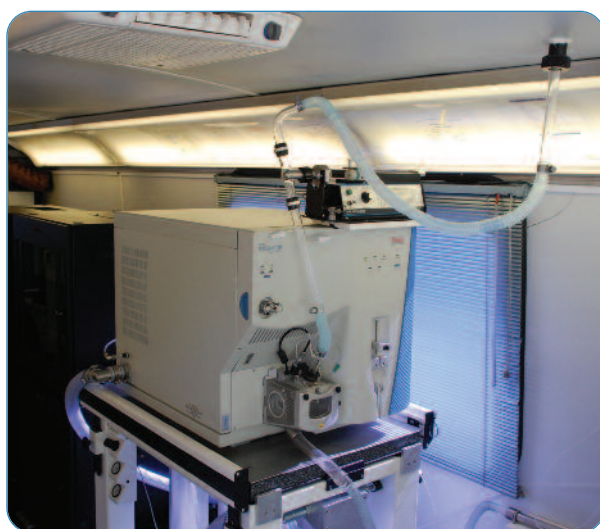

Figure 1: TSQ Series triple stage quadrupole with the ion source customized for direct air sampling.

Table 1. Ambient air quality criteria for common contaminants (limits of acceptance)

Compound	Limit Concentration (maximum mean/4 minutes) ( $\mu\text{g}/\text{m}^3$ )	Limit of Detection (MS/MS) ( $\mu\text{g}/\text{m}^3$ )
Acetone	8600	4
Acrylic acid	270	0.1
Ethyl-3-ethoxypropionate	300	0.02
Ethylacetate	20	16
Hydrogen chloride	1150	8
Methyl-ethyl ketone	740	6
Naphthalene	200	2
Phenol	160	0.4
Propylene glycol monomethyl ether (PGME)	ND	1
Sulfur dioxide	1050	0.3
Triethylamine	22	5

## Goal

- 1) To develop a rapid, on-site, real-time air analysis method to identify and quantitate several common air contaminants.
- 2) To demonstrate the advantages of using the Thermo Scientific Ion Max source and tandem mass spectrometry (MS/MS) for the detection and determination of a selected range of atmospheric pollutants.
- 3) To establish and validate methods for air quality control programs, emission inventory and reporting, compliance and enforcement.

## Key Words

- Environmental Monitoring
- TSQ Series Triple Quadrupole MS

## Experimental

### Preparation of Standards

Standards were prepared by infusing saturated vapor of standard-grade samples of phenol, propylene glycol monomethyl ether (PGME), methyl-ethyl ketone (MEK), and ethylacetate, respectively into a flow of ambient air using a gastight syringe pumping system connected to the Ion Max™ source of the mass spectrometer (Figure 2). The concentrations of standards were calculated as a function of the infusion rate of saturated vapor of the respective standards into a non-contaminated, continuous flow of atmospheric air, drawn under normal conditions of temperature and pressure. See Tables 2 and 3.

$$\text{Conc}(\text{ppb}) = \frac{P_s}{P_a} \times \frac{I}{F} \times 1000$$

$P_s$  = Vapor pressure of the compound (mm Hg at 21 °C)

$P_a$  = Atmospheric pressure (mm Hg at 21 °C)

$I$  = Infusion rate ( $\mu\text{L}/\text{min}$ )

$F$  = Sampling pump flow (L/min)

$$\text{Conc}(\mu\text{g}/\text{m}^3) = \text{Conc}(\text{ppb}) \times \frac{W}{V}$$

$W$  = Molecular weight of analyzed compound

$V$  = Volume (24 liters at 21 °C)

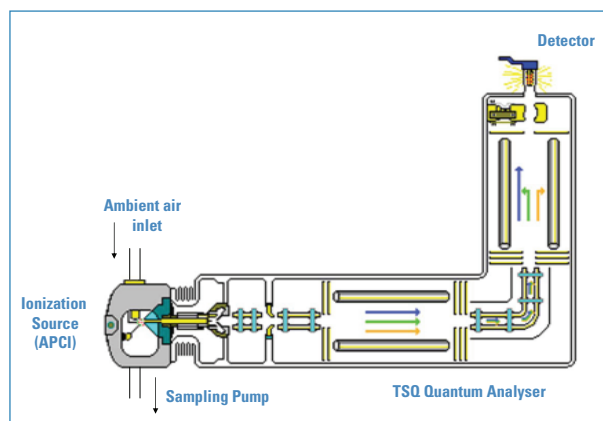

Figure 2: Block diagram of the TSQ Series triple stage quadrupole mass spectrometer custom source.

Table 3. Sample calculation of concentrations of compounds of interest.

	Phenol	Ethylacetate	MEK	PGME
Vapor pressure (Ps)	0.62	75.1	75.6	12
Syringe capacity (mL)	5	1	1	1
Speed setting	9	7	2	7
Infusion rate ( $\mu\text{L}/\text{min}$ )	1250	100	15	100
Sampling pump flow (L/min)	57	57	55	57
Molecular weight	94	88	72	90
Concentration (ppb)	18	173	27	28
Concentration ( $\mu\text{g}/\text{m}^3$ )	70	636	81	104

### Sample Analysis

Air samples were drawn directly from open atmosphere into the Ion Max source housing through the built-in probe aperture. The set-up consisted of an infusion pump regenerative blower, with the drain tube of the source chamber serving as the outlet. Following APCI, the resulting ions entered the mass spectrometer through the ion transfer tube interface.

### MS Conditions

Mass spectrometer:	Thermo Scientific TSQ Quantum Discovery MAX
APCI corona voltage:	4 kV (- 4 kV in negative ion mode)
Ion transfer tube temperature:	180 °C
Skimmer offset:	5 V
CID gas pressure:	1.5 mTorr
Resolution:	Unit Resolution (0.7 FWHM)
Analytical scan type:	Selective reaction monitoring (SRM)
SRM conditions:	Scan time: 50 ms
	Scan width: 1.000 Da

The MS/MS experimental conditions for SRM are shown in Table 4.

Table 2. Calibration of the infusion pump (Correlation between syringe speed and infusion rate).

Syringe capacity	Syringe speed								
	1	2	3	4	5	6	7	8	9
	Flow rate ( $\mu\text{L}/\text{min}$ )								
10 $\mu\text{L}$	0.1	0.15	0.20	0.35	0.50	0.75	1.0	1.5	2.5
100 $\mu\text{L}$	1.0	1.5	2.0	3.5	5.0	7.5	10	15	25
1 mL	10	15	20	35	50	75	100	150	250
2.5 mL	25	38	50	88	125	188	250	375	625
5 mL	50	75	100	175	250	375	500	750	1250
10 mL	100	150	200	350	500	750	1000	1500	2500
50 mL	350	560	720	1230	1800	2560			

Table 4. MS/MS experimental conditions for SRM.

Compound	Precursor Ion ( <i>m/z</i> )	Product Ion ( <i>m/z</i> )	Tube Lens Voltage (V)	Collision Energy (V)
<sup>13</sup> C <sub>2</sub> -acetic acid	94	61	56	11
d <sub>6</sub> -acetone	65	33	82	18
Ethylacetate	89	61	45	8
MEK	73	43	108	13
PGME	91	31	54	21
PGME	91	73	54	5
Phenol	126	93	35	13

## Results and Discussion

In negative ion mode, <sup>13</sup>C<sub>2</sub>-acetic acid was used as an internal standard. Acetic acid produced a deprotonated molecule (*m/z* 94) [<sup>13</sup>CH<sub>3</sub><sup>13</sup>COOH·O<sub>2</sub>]<sup>-</sup> which, under CID conditions, produces CH<sub>3</sub>COO<sup>-</sup> (*m/z* 61). Phenol forms an analog adduct [C<sub>6</sub>H<sub>5</sub>OH·O<sub>2</sub>]<sup>-</sup> (*m/z* 126), which yields a product ion at *m/z* 93, C<sub>6</sub>H<sub>5</sub>O<sup>-</sup>.

In positive ion mode, acetone-d<sub>6</sub> (*m/z* 65 to *m/z* 33) was used as an internal standard. Two precursor ion – product ion transitions were monitored, *m/z* 91 to *m/z* 31 and *m/z* 91 to *m/z* 73, respectively, in multiple reaction monitoring (MRM) mode for the analysis of PGME.

The limit of detection (LOD) is the concentration equivalent of 3x standard deviation of the response at the background level (i.e., ambient air, in the absence of the subject compound).

The calibration data for ethylacetate, MEK, PGME, and phenol are shown in Figures 3 through 10. The quantitative results are listed in Tables 5 through 8.

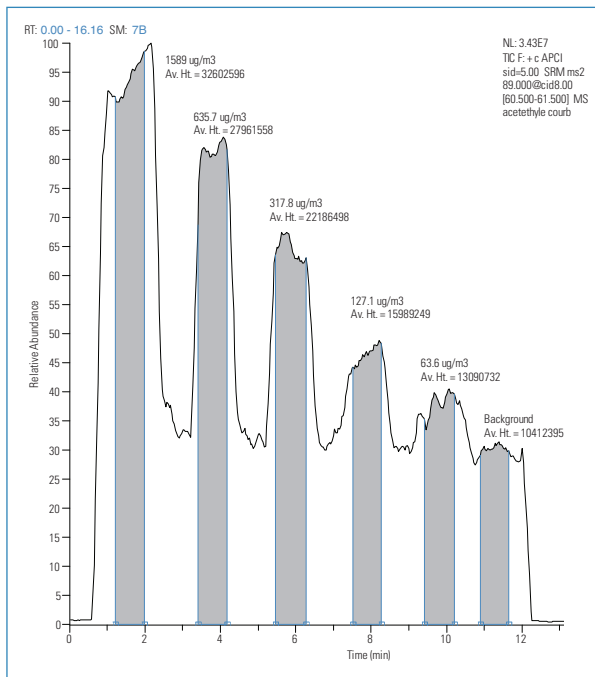

Figure 3: Reconstructed ion trace for ethylacetate to produce the calibration curve.

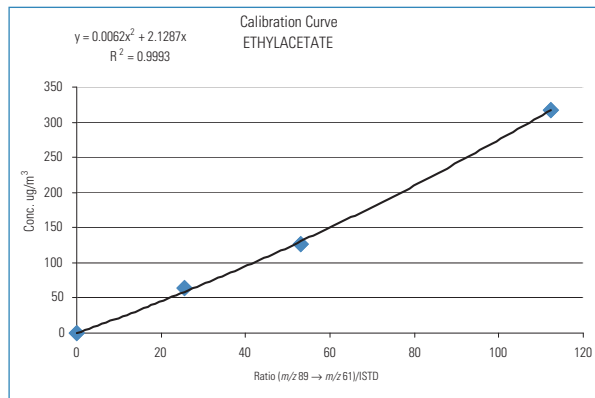

Figure 4: Calibration curve for ethylacetate.

Table 5. Quantitative results for ethylacetate and LOD determination.

ETHYLACETATE					
<b>ISTD: Acetone d<sub>6</sub>, syringe 1 mL, Speed 2</b>					
<b>SRM (m/z 65 → m/z 33)</b>					
RT (min.)	Syringe Speed	Average Height	Background Subtracted		
10.5	OFF	26000			
15.55	2	130873	104873		
<b>Ethylacetate</b>					
<b>SRM (m/z 89 → m/z 61)</b>					
RT (min)	Syringe Speed	Average Height	Background Subtracted	Response/ISTD Ratio	Concentration (µg/m <sup>3</sup> )
1.2 - 2.0	9	32602596	22190201		
3.4 - 4.2	7	27961558	17549163		
5.5 - 6.3	5	22186498	11774103	112.3	317.8
7.5 - 8.3	3	15989249	5576854	53.2	127.1
9.4 - 10.2	1	13090732	2678337	25.5	63.6
	OFF	10412395	0	0.0	0
		(3 x Std. Dev.) =	654194	6.24	16.2

Std. Dev. = 218065  
**LOD**

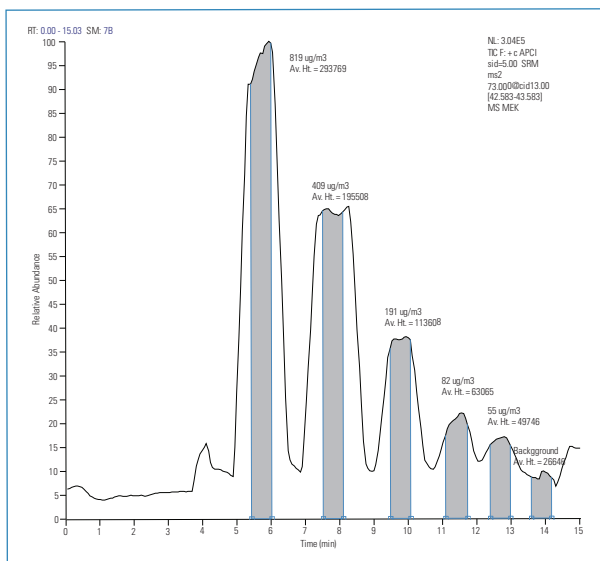

Figure 5: Reconstructed ion trace for MEK to produce the calibration curve.

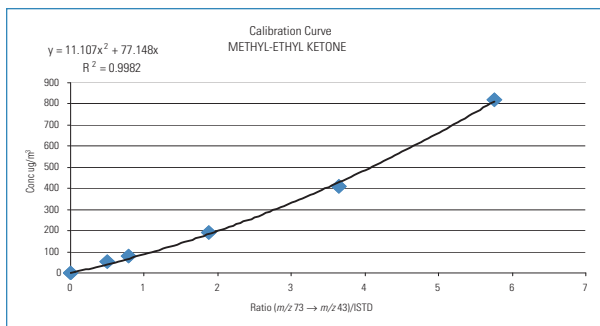

Figure 6: Calibration curve for MEK.

Table 6. Quantitative results for MEK, and LOD determination.

METHYL-ETHYL KETONE (MEK)					
ISTD: Acetone d <sub>6</sub> , syringe 1 mL, Speed 2					
SRM (m/z 65 → m/z 33)					
RT	Syringe Speed	Aver Height	Background Subtracted		
3.03	OFF	45240			
2.38		91628	46388		
Methyl-ethyl ketone					
SRM (m/z 65 → m/z 33)					
RT (min)	Syringe Speed	Average Height	Background Subtracted	Response/ISTD Ratio	Concentration (µg/m <sup>3</sup> )
5.4 - 6.0	9	293769	267123	5.8	819
7.5 - 8.1	7	195508	168862	3.6	409
9.5 - 10.1	5	113608	86962	1.9	191
11.1 - 10.7	3	63065	36419	0.8	82
12.4 - 13.0	1	49746	23100	0.5	55
13.6 - 14.2	OFF	26646	0	0.0	0
		(3 x Std. Dev.) =	3300	0.1	6

Std. Dev. = 1100  
**LOD**

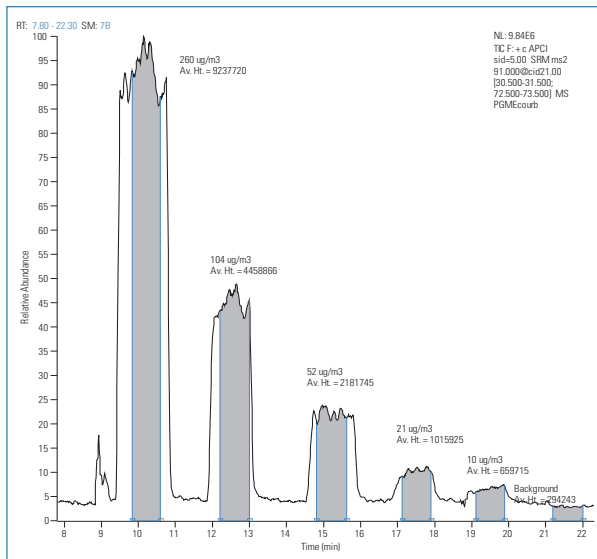

Figure 7: Reconstructed ion trace for PGME to produce the calibration curve.

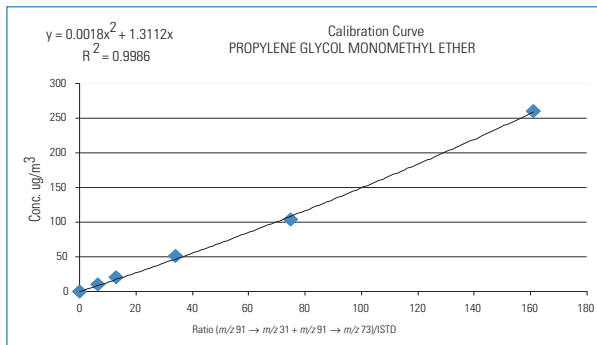

Figure 8: Calibration curve for PGME.

Table 7. Quantitative results for PGME, and LOD determination.

PROPYLENE GLYCOL MONOMETHYL ETHER (PGME)					
<b>ISTD: Acetone d<sub>6</sub>, syringe 1 mL, Speed 2</b>					
<b>SRM (m/z 65 → m/z 33)</b>					
RT	Syringe Speed	Aver Height	Background Subtracted		
11.00	OFF	12500			
7.30		68039	55539		
<b>Propylene Glycol Monomethyl Ether (PGME)</b>					
<b>MRM (m/z 91 → m/z 33 + m/z 91 → m/z 73)</b>					
RT (min)	Syringe Speed	Average Height	Background Subtracted	Response/ISTD Ratio	Concentration (µg/m <sup>3</sup> )
9.8 - 10.6	9	9237720	8943477	161.0	260
12.2 - 13.0	7	4458866	4164623	75.0	104
14.8 - 15.6	5	2181745	1887502	34.0	52
17.1 - 17.9	3	1015925	721682	13.0	21
19.1 - 19.9	1	659715.5	365473	6.6	10
21.2 - 22.0	OFF	294243	0	0.0	0
		(3 x Std. Dev.) =	45785	0.8	1

Std. Dev. = 15262  
**LOD**



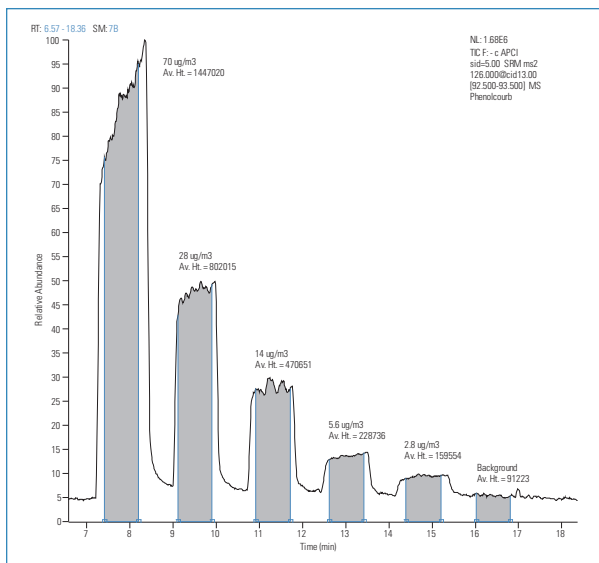

Figure 9: Reconstructed ion trace for phenol to produce the calibration curve.

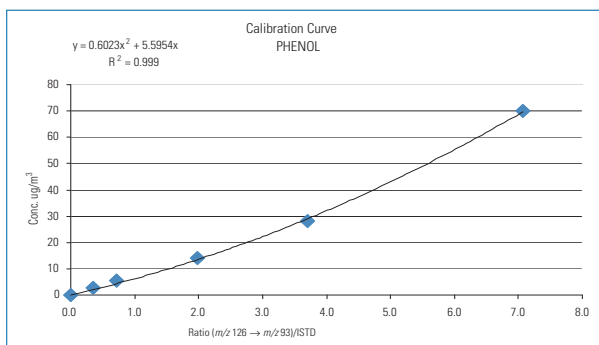

Figure 10: Calibration curve for phenol.

Table 8. Quantitative results for phenol, and LOD determination.

PHENOL					
<b>ISTD: Acetic acid <sup>13</sup>D<sub>2</sub>, syringe 1 mL, Speed 2</b>					
<b>SRM (m/z 94 → m/z 61)</b>					
RT	Syringe Speed	Aver Height	Background Subtracted		
6.0	OFF	57639			
4.6		249205	191566		
<b>Phenol</b>					
<b>SRM (m/z 126 → m/z 93)</b>					
RT (min)	Syringe Speed	Average Height	Background Subtracted	Response/ISTD Ratio	Concentration (µg/m <sup>3</sup> )
7.4 - 8.2	9	1447020	1355797	7.1	70
9.1 - 9.9	7	802015	710792	3.7	28
10.9 - 11.7	5	470651	379428	2.0	14
12.6 - 13.4	3	228736	137513	0.7	5.6
14.4 - 15.2	1	159554	68331	0.4	2.8
16.0 - 16.8	OFF	91223	0	0.0	0
		(3 x Std. Dev.) =	11613	0.06	0.4

Std. Dev. = 3871  
**LOD**

## Conclusion

The custom TSQ Series triple stage quadrupole mass spectrometer system allows the detection and quantitative analysis of a series of chemical pollutants in ambient air. Concentration of these pollutants can be determined in a real-time fashion for immediate action in case of chemical spills, fire, etc., or for the purpose of trending in environmental monitoring.

This application demonstrates that LODs can be achieved with the TSQ Series triple stage quadrupole mass spectrometer in real time, without sample pre-concentration or any separation technique. The achieved

LOD values are lower than the regulatory limits for the respective compounds.

The custom configuration of the TSQ Series triple stage quadrupole mass spectrometer is well-suited for installation in mobile laboratories (Figure 11). Such configuration demonstrates, in addition to the reliability and ruggedness of the TSQ instrumentation, applicability of the system to on-site environmental analysis. In emergency situations, like fires or chemical spills, these mobile facilities are essential for real-time ambient air analysis.



Figure 11: The mobile laboratory of MDDEP Québec, Canada, containing the rugged and reliable TSQ Series triple quadrupole system functioning dynamically on-board.

*In addition to these offices, Thermo Fisher Scientific maintains a network of representative organizations throughout the world.*

**Africa-Other**  
+27 11 570 1840

**Australia**  
+61 3 9757 4300

**Austria**  
+43 1 333 50 34 0

**Belgium**  
+32 53 73 42 41

**Canada**  
+1 800 530 8447

**China**  
+86 10 8419 3588

**Denmark**  
+45 70 23 62 60

**Europe-Other**  
+43 1 333 50 34 0

**Finland/Norway/Sweden**  
+46 8 556 468 00

**France**  
+33 1 60 92 48 00

**Germany**  
+49 6103 408 1014

**India**  
+91 22 6742 9434

**Italy**  
+39 02 950 591

**Japan**  
+81 45 453 9100

**Latin America**  
+1 561 688 8700

**Middle East**  
+43 1 333 50 34 0

**Netherlands**  
+31 76 579 55 55

**New Zealand**  
+64 9 980 6700

**South Africa**  
+27 11 570 1840

**Spain**  
+34 914 845 965

**Switzerland**  
+41 61 716 77 00

**UK**  
+44 1442 233555

**USA**  
+1 800 532 4752

[www.thermoscientific.com](http://www.thermoscientific.com)

### Legal Notices

©2016 Thermo Fisher Scientific Inc. All rights reserved. All trademarks are the property of Thermo Fisher Scientific Inc. and its subsidiaries. This information is presented as an example of the capabilities of Thermo Fisher Scientific Inc. products. It is not intended to encourage use of these products in any manners that might infringe the intellectual property rights of others. Specifications, terms and pricing are subject to change. Not all products are available in all countries. Please consult your local sales representative for details.

AN63193\_E 08/16S

# Consolidated GC-MS/MS Analysis of OCPs, PAHs, and PCBs in Environmental Samples

Inge de Dobbeleer, Joachim Gummersbach, Hans-Joachim Huebschmann, Anton Mayer, Paul Silcock  
Thermo Fisher Scientific, Dreieich, Germany

## Key Words

Organochlorine pesticides, polychlorinated biphenyls, polyaromatic hydrocarbons, soil samples, water samples, building material, repeatability, linearity

## Goal

To describe the analysis of semivolatile compounds in various environmental matrices, showing the productivity and high quality results of the GC-MS/MS system.

## Introduction

Organochlorine pesticides (OCP), polyaromatic hydrocarbons (PAH), and polychlorinated biphenyls (PCB) are compound classes that are highly familiar to routine environmental or contract testing laboratories. Various approaches are taken to address these compound classes in the diverse matrix environment experienced by these laboratories.

Gas chromatography-mass spectrometry (GC-MS) is well suited for the analysis of OCPs, PAHs, and PCBs. Single quadrupole GC-MS has offered the opportunity for the environmental laboratory to increase selectivity for these analytes over that of classical detectors, such as UV and fluorescence detectors in HPLC and ECD and FID detectors in GC. This has allowed for limited optimization of sample preparation procedures to increase time to result and ultimately reduce laboratory costs.

Triple quadrupole GC-MS/MS provides a significant increase in selectivity when compared to single quadrupole GC-MS. This selectivity has a profound effect on the ability to cut through chemical background (interference), which enhances the capability and productivity of an environmental testing laboratory. This technique is being increasingly utilized by many environmental laboratories, especially those looking for a competitive edge.

Unfortunately, for laboratories newer to GC-MS/MS, the adoption of this technique presents a challenge in realizing the productivity advantages offered without significantly impacting continued laboratory operations.<sup>1,2</sup>

This application note describes a high performance, highly productive analysis of OCPs, PAHs and PCBs in environmental samples through a consolidated GC-MS/MS method using the Thermo Scientific™ TRACE™ 1310 GC and the TSQ™ 8000 triple quadrupole GC-MS/MS. Also described is the use of smart software tools that are integrated into the method development and analysis workflow to minimize the time needed to implement and maintain the methodology in routine.

## Experimental Conditions

### Sample Preparation

#### Water samples

To 1 L of sample, n-hexane was added and the mixture was shaken. After the separation of water and organic phases, the organic phase was removed and dried with anhydrous Na<sub>2</sub>SO<sub>4</sub>. An aliquot of the organic extract was evaporated to a volume of 3–4 mL and then evaporated under a gentle nitrogen stream to the final volume.

#### Solid samples

Into a glass jar, 10 g of the sample (soil, sediment, or building material) was weighed, then anhydrous Na<sub>2</sub>SO<sub>4</sub> and 40 mL of extraction solvent mixture (hexane and acetone) were added. The glass jar was sealed with a Teflon® seal and sonicated for 20 min. An aliquot of the sample extract was placed into a Kuderna – Danish apparatus, and another 40 mL of extraction solvent mixture was added to the sample and the extraction was repeated. An aliquot of second extraction was added to the first extraction aliquot. The extract was evaporated to a volume of 3–4 mL and then evaporated under a gentle nitrogen stream to the final volume.

## Method Setup

A method was developed for the Thermo Scientific TRACE™ 1310 Gas Chromatograph and the TSQ 8000 Mass Spectrometer (Table 1).

Table 1. Recommended instrument conditions

TRACE 1310 GC	
Injection Volume:	1 µL
Liner:	Siltec baffled liner (P/N 453T2120)
Carrier Gas:	He, constant flow, 1.15 mL/min
Column Type:	20 m, 18 mm ID, 0.18 µm df, TG-XLBMS (P/N 26079-5780)
Column Oven:	Initial 60 °C, hold 1 min. Ramp 30.0 °C min to 200 °C. Ramp 10.0 °C min to 320 °C. Hold 2.0 min.
Transfer Line:	320 °C
TRACE 1310 GC PTV program	
Injector Temperature:	80 °C, Splitless Injection 1 min
PTV Inject:	80 °C, 0.1 min. 600 °C/min to transfer step
PTV Transfer:	320 °C, 5 min, 870 °C/min to clean step
PTV Clean:	325 °C, 15 min, clean flow 25 mL/min
TSQ 8000 Mass Spectrometer in EI mode	
Source Temperature:	350 °C
Ionization:	EI, 70 eV
Emission Current:	50 µA
Resolution:	Q1 normal
Collision Gas:	Argon

## Method Adoption: Mass Spectrometer Acquisition Method and Quantitation Method

With the TSQ 8000 GC-MS/MS system, the operator can perform automated SRM method development, shortening the method development time considerably.

AutoSRM accelerated the method development process. The optimized parameters were tracked in a clear and simple way. The program started from a Full Scan analysis, and the peaks were identified with a library search. Clicking on each peak revealed a list of most intense ions, and those were selected to be pushed into a working list and used for the second injection, the product ion scan.

The results were again plotted into a chromatogram and, by clicking on the peaks, the product ions were listed into a table of decreasing intensity. Finally those product ions were pushed into a working list, and the final optimization started where the ions were subjected to increasing collision energy. This was plotted into a graphical representation and into a third working list. Selecting this working list created a SRM method for all compounds, which was linked to a full instrument method. Furthermore, the transitions and the retention times were exported into a compound data base, linking the method automatically to a quantitative method in Thermo Scientific TraceFinder™ software.

A comprehensive explanation is found in application brief *AB52998: Introducing AutoSRM: MRM Simplicity for High Performance Results.*<sup>3</sup>

## Tuning

A complete automated tuning was provided with the TSQ 8000 GC-MS, ensuring reproducible tuning, even when different users were working with the instrument. The tune contained an automated leak check using the ratio between the native air/water background and a metered amount of air introduced into the source.

The tuning was saved to the instrument automatically and the last tune file was coupled to the instrument method by default, but it was also perfectly possible to attach another tune file to the method.

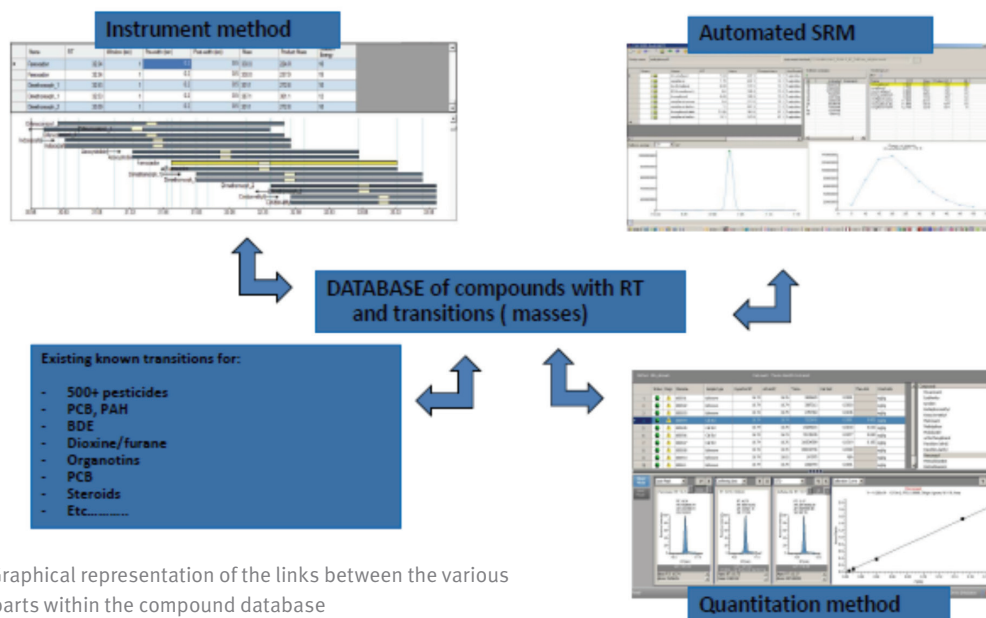

Figure 1. Graphical representation of the links between the various software parts within the compound database

### Method Productivity & Performance

The goal of the developed method was to decrease the total work required by the laboratory for the analyses of so many compounds. For this entire list of compounds to be analyzed effectively, the TRACE 1310 GC and TG-XLBMS column were used to optimize the chromatographic separation of critical isomer pairs.

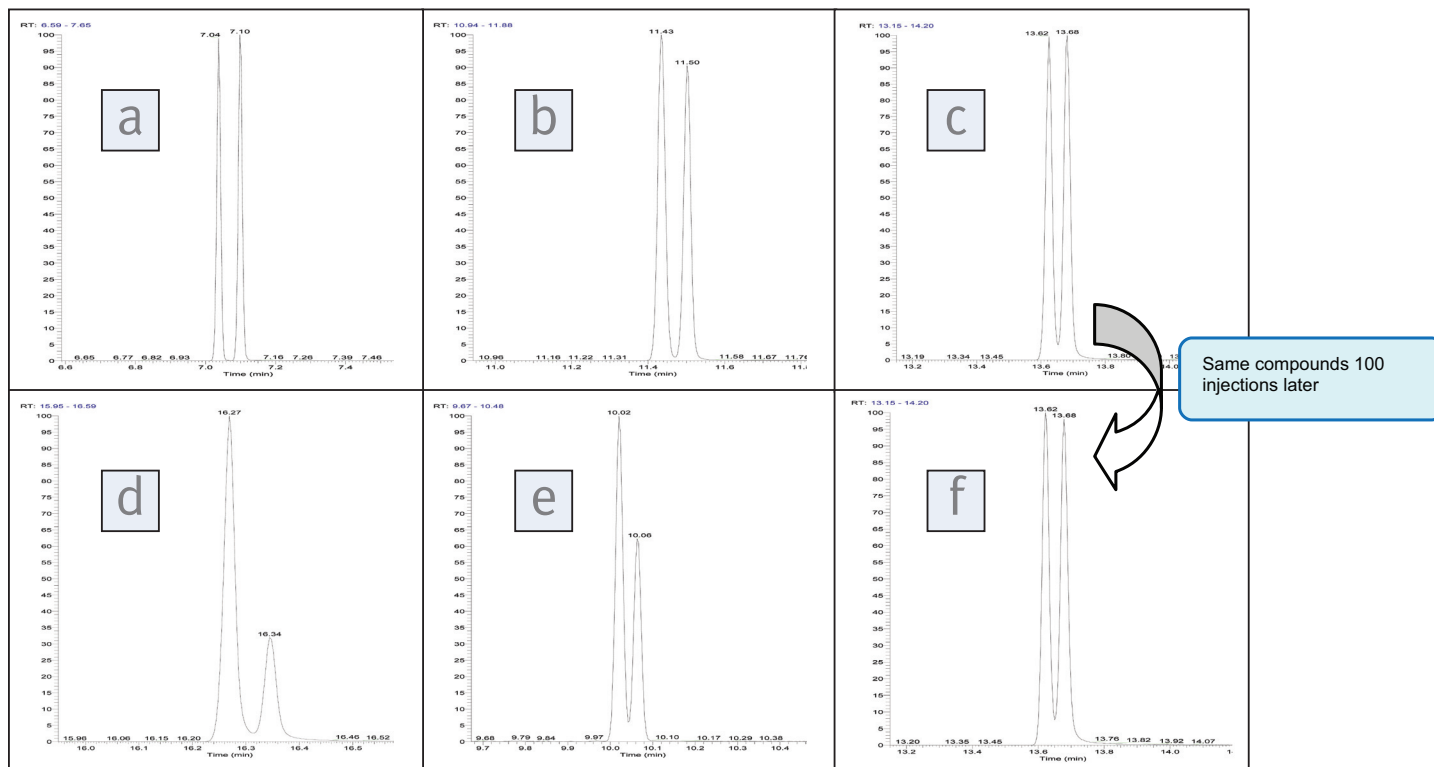

Figure 2: Chromatograms of several critical separations in a standard at 2000 pg absolute injection; except for benzo(b) and (k) fluoranthene that are depicted in building material with a concentration of 400 pg

- a: phenanthrene and anthracene
- b: chrysene and benzo(a)anthracene
- c: benzo(b) and benzo(k)fluoranthene
- d: indeno (1,2,3,c,d)pyrene and dibenzo(a,h) anthracene
- e: o,p DDD and p,p DDT
- f: benzo(b) and benzo(k)fluoranthene in building material **after 100 injections of samples**

The chromatographic performance was such that all compounds eluted within 17 minutes. The same separations were observed after more than 100 injections of water, soil, and building material extracts.

### Calibration Curves

Calibration curves were produced in the range of 2 µg/L to 700 µg/L for the OCPs and PCBs. A higher range, 2 µg/L to 2,500 µg/L, was necessary for the PAHs. The curves were not corrected for internal standard calibration.

All curves had a regression coefficient higher than 0.995. Curves for a selection of target compounds are plotted in Figures 3 & 4.

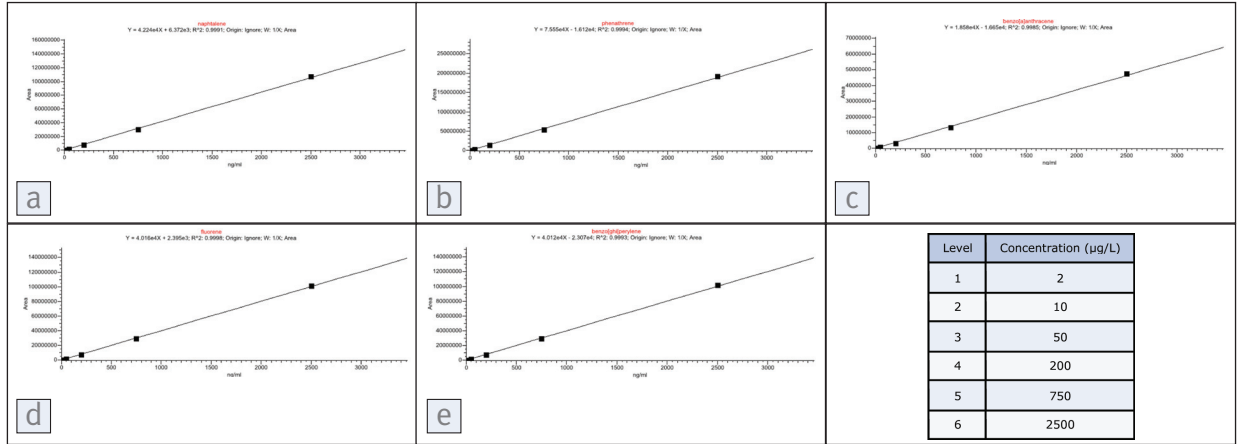

Figure 3: Calibration curves of various PAHs. The compounds and their respective regression coefficients were:

- a: naphthalene with  $R^2=0.9991$
- b: phenanthrene with  $R^2= 0.9994$
- c: benzo(a) anthracene with  $R^2= 0.9985$
- d: fluorene with  $R^2= 0.9998$
- e: benzoperylene with  $R^2= 0.9993$

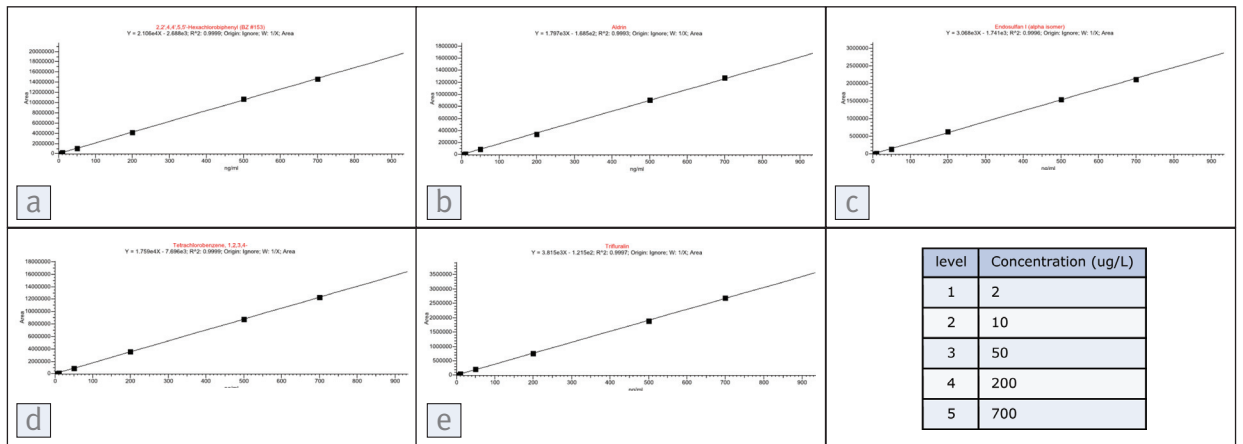

Figure 4: Calibration curves of various pesticides. The compounds and their respective regression coefficients were:

- a: PCB153 with  $R^2=0.9999$
- b: aldrin with  $R^2= 0.9993$
- c: alpha endosulfan with  $R^2= 0.9996$
- d: tetrachlorobenzene with  $R^2= 0.9999$
- e: trifluralin with  $R^2= 0.9999$

### Compounds at 2 µg/L level

At the lowest calibrated level (2 µg/L or 2 pg on column), all compounds gave excellent responses and high signal-to-noise values. A selection of extracted SRM chromatograms at this level are given in Figure 5.

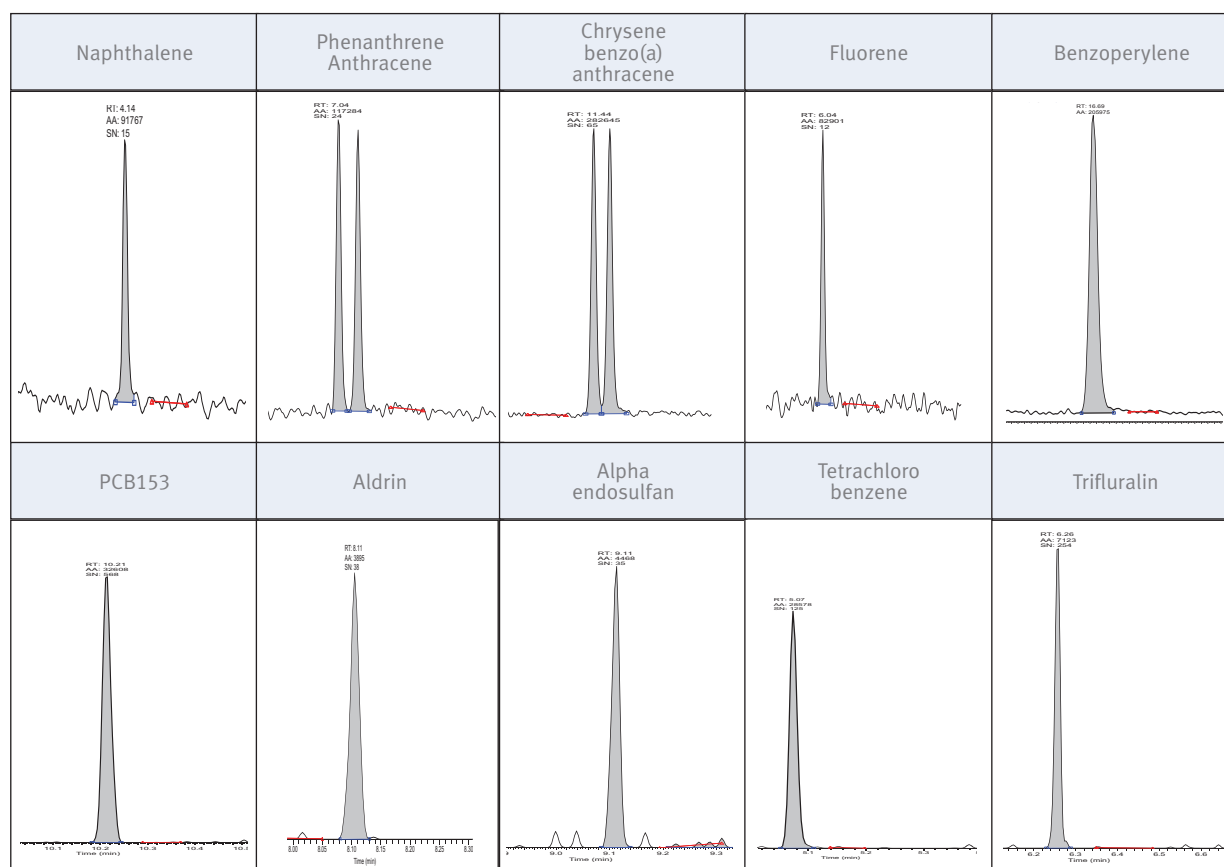

Figure 5: Peaks at 2 µg/L level; 2 pg absolute amount injected on column

### Precision in Spiked Matrix Samples

In all three matrices, the repeatability was established by performing repeat injections of spiked soil extracts, spiked water extracts, and spiked building material extracts. All samples were analyzed seven times, and the RSD was calculated using an external calibration (Table 2).

Repeatability for all compounds in the matrix was below 10% RSD. TraceFinder software performed all integrations without manual intervention.

Table 2: Relative standard deviation of seven injected samples in various matrices

Compound	% RSD		
	Building Material	Soil	Water
PCB180	2.5	6.4	5.3
PCB118	2.8	5.7	4.3
Benzo[a]anthracene	2.7	1.6	6.7
Benzo[a]pyrene	2.5	2.4	7.2
Benzo[b]fluoranthene	2.2	3.2	7.5
BHC-gamma (Lindane, gamma HCH)	2.9	7.3	7.8
Dieldrin	4.2	3.5	6.9
Endosulfan I (alpha isomer)	2.9	7.2	7.2
Endosulfan II (beta isomer)	3.4	7.7	7.3



## Ion Ratio Stability

All compounds had at least two transitions in the method, and the two ions had been monitored throughout the samples, blanks, and standards.

Hexachloroethane	Ratio	Benzoperylene	Ratio
<b>Average</b>	0.479	<b>Average</b>	2.910
<b>Standard deviation</b>	0.025	<b>Standard deviation</b>	0.124
<b>RSD</b>	5.3%	<b>RSD</b>	4.3%

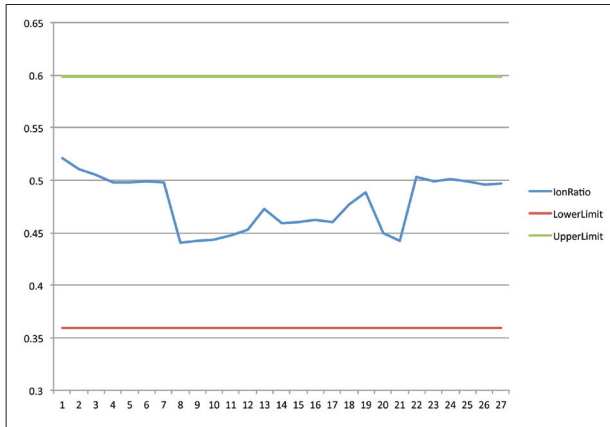

Figure 6: Ion ratio of hexachloroethane, plotted with the upper and lower allowed limit according to the EU guidelines for performance of analytical methods.<sup>4</sup> The average and the standard deviation are shown in the table above.

Throughout the complete series of calibration curves, water samples, soil samples, and building materials, the ion ratios were calculated. The ion ratio precision demonstrated good confirmation in both samples and standard injections across the concentration range.

## Sample Results

A small selection of compound peaks at low levels in matrix is shown in Figure 7, demonstrating the sensitivity and selectivity of the measurements.

Below, a selection of matrix and compounds at low levels, and the concentrations, are given as the absolute amount on column.

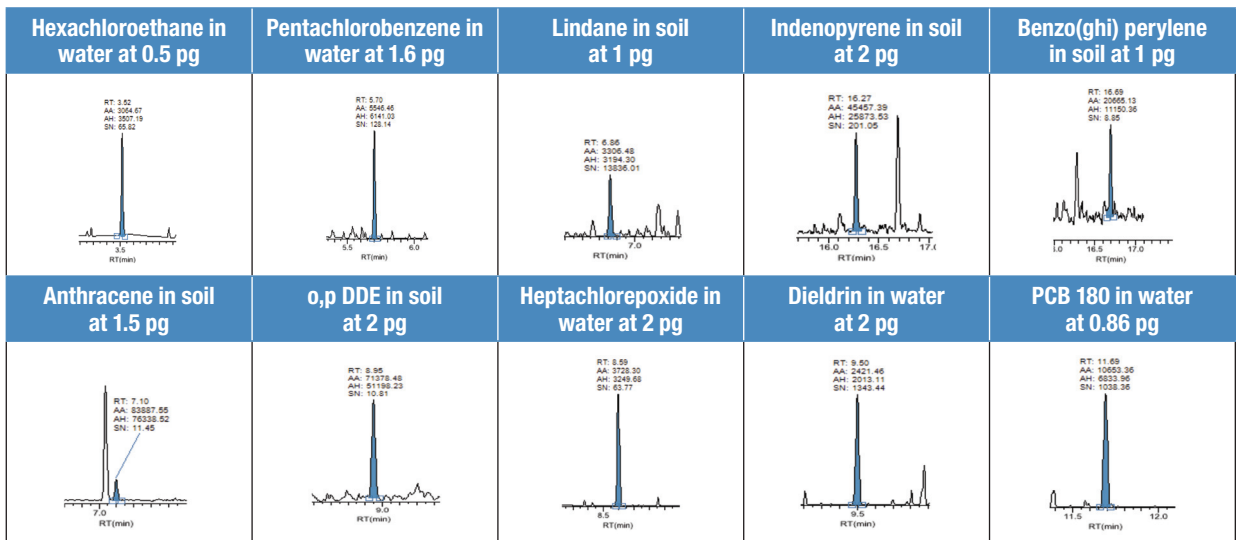

Figure 7: Compound peaks in various sample matrices at low levels

## Conclusions

- The TSQ 8000 GC-MS/MS enabled simple method development, validation, and management using a combination of integrated software tools.
- The new method increased productivity in the laboratory by combining three separate methods into one, from three injections down to one injection.
- Quantitative performance of the system and methodology was excellent with a good level of linearity, excellent sensitivity, and high precision in a variety of environmental sample types.

## References

1. Analysis of emerging persistent organic pollutants using GC-MS/MS; Kalachova *et al.* SETAC, Berlin 2012.
2. Ziegenhals, K.; Hubschmann, H.J. Fast-GC/HRMS to quantify the EU priority PAH. *J. Sep. Sci.* 2008, 31, 1779 – 1786.
3. Thermo Scientific Application Brief AB52998: Introducing AutoSRM: MRM Simplicity for High Performance Results; Cole J.
4. REGULATION (EC) No 2002/657 on analytical performance criteria.
5. Pesticides Method Reference, 2<sup>nd</sup> ed. 2011, Thermo Fisher Scientific, Austin, TX, USA, P/N 120390.

## Addendum: SRM Transitions

Parent Mass (Da)	Product Mass (Da)	Collision Energy (V)	RT (min)	Start Time* (min)	Stop Time* (min)	Name
427.77	357.80	25	13.20	12.68	13.68	2,2',3,3',4,4',5,5'-Octachlorobiphenyl (BZ #194)
429.76	357.80	25	13.20	12.68	13.68	2,2',3,3',4,4',5,5'-Octachlorobiphenyl (BZ #194) Confirming 1
391.81	321.84	25	11.70	11.16	12.16	2,2',3,4,4',5,5'-Heptachlorobiphenyl (BZ #180)
393.81	323.84	25	11.70	11.16	12.16	2,2',3,4,4',5,5'-Heptachlorobiphenyl (BZ #180) Confirming 1
357.84	287.88	25	10.20	9.70	10.70	2,2',4,4',5,5'-Hexachlorobiphenyl (BZ #153)
359.84	289.87	25	10.20	9.70	10.70	2,2',4,4',5,5'-Hexachlorobiphenyl (BZ #153) Confirming 1
289.92	219.94	20	7.87	7.37	8.37	2,2',5,5'-Tetrachlorobiphenyl (BZ #52)
291.92	219.94	20	7.87	7.37	8.37	2,2',5,5'-Tetrachlorobiphenyl (BZ #52) Confirming 1
323.88	253.91	20	9.88	9.38	10.38	2,3',4,4',5-Pentachlorobiphenyl (BZ #118)
325.88	255.91	20	9.88	9.38	10.38	2,3',4,4',5-Pentachlorobiphenyl (BZ #118) Confirming 1
255.96	185.97	20	7.48	6.98	7.98	2,4,4'-Trichlorobiphenyl (BZ #28)
257.96	185.97	20	7.48	6.98	7.98	2,4,4'-Trichlorobiphenyl (BZ #28) Confirming 1
153.07	126.05	45	5.58	5.08	6.08	acenaphtene
153.07	151.07	40	5.58	5.08	6.08	acenaphtene Confirming 1
164.14	160.00	30	5.55	5.05	6.05	acenaphtene D10
164.14	162.00	20	5.55	5.05	6.05	acenaphtene D10 Confirming 1
152.06	102.03	30	5.43	4.93	5.93	acenaphthylene
152.06	126.05	20	5.43	4.93	5.93	acenaphthylene Confirming 1
276.08	272.08	60	16.70	16.20	17.20	benzo[ghi]perylene
276.08	274.08	40	16.70	16.20	17.20	benzo[ghi]perylene Confirming 1
216.89	180.91	8	6.48	5.98	6.98	BHC-alpha (benzene hexachloride)
218.89	182.91	8	6.48	5.98	6.98	BHC-alpha (benzene hexachloride) Confirming 1
240.17	212.00	30	11.40	10.94	11.94	chrysene D12
240.17	236.00	30	11.40	10.94	11.94	chrysene D12 Confirming 1
235.01	164.98	20	9.50	9.00	10.00	DDD-o,p'
237.01	164.98	20	9.50	9.00	10.00	DDD-o,p' Confirming 1
495.69	425.73	25	14.30	13.79	14.79	Decachlorobiphenyl (BZ #209)
497.69	427.73	25	14.30	13.79	14.79	Decachlorobiphenyl (BZ #209) Confirming 1
278.08	274.08	60	16.30	15.82	16.82	dibenzo[ah]anthracene

\* Start and Stop Times are set automatically in timed-SRM mode of the TSQ 8000 by using a standard acquisition window of 60 s for all compounds

## Addendum: SRM Transitions

Parent Mass (Da)	Product Mass (Da)	Collision Energy (V)	RT (min)	Start Time* (min)	Stop Time* (min)	Name
278.08	276.08	30	16.30	15.82	16.82	dibenzo[ah]anthracene Confirming 1
170.96	135.97	15	4.88	4.38	5.38	Dichlorobenzonitrile, 2,6- (Dichlobenil)
172.96	137.97	15	4.88	4.38	5.38	Dichlorobenzonitrile, 2,6- (Dichlobenil) Confirming 1
276.91	240.92	12	9.50	9.00	10.00	Dieldrin
278.91	242.92	12	9.50	9.00	10.00	Dieldrin Confirming 1
165.08	139.04	30	6.04	5.54	6.54	fluorene
165.08	163.08	30	6.04	5.54	6.54	fluorene Confirming 1
269.88	234.89	15	7.67	7.17	8.17	Heptachlor
271.88	236.89	15	7.67	7.17	8.17	Heptachlor Confirming 1
283.81	248.84	20	6.57	6.07	7.07	Hexachlorobenzene
285.81	250.83	20	6.57	6.07	7.07	Hexachlorobenzene Confirming 1
224.80	189.90	18	4.26	3.76	4.76	Hexachlorobutadiene
226.90	189.90	18	4.26	3.76	4.76	Hexachlorobutadiene Confirming 1
226.90	191.90	18	4.26	3.76	4.76	Hexachlorobutadiene Confirming 2
310.83	240.87	25	8.25	7.75	8.75	Isobenzan (Telodrin)
312.83	242.87	25	8.25	7.75	8.75	Isobenzan (Telodrin) Confirming 1
227.01	169.01	20	10.80	10.30	11.30	Methoxychlor, o,p'-
227.01	184.08	20	10.80	10.30	11.30	Methoxychlor, o,p'- Confirming 1
128.06	77.05	30	4.15	3.65	4.65	naphthalene
128.06	102.03	20	4.15	3.65	4.65	naphthalene Confirming 1
136.11	108.03	25	4.12	3.62	4.62	naphthalene D8
136.11	134.06	25	4.12	3.62	4.62	naphthalene D8 Confirming 1
247.85	141.92	25	5.68	5.18	6.18	Pentachlorobenzene
247.85	212.87	25	5.68	5.18	6.18	Pentachlorobenzene Confirming 1
264.00	230.00	30	14.40	13.85	14.85	perylene D12
264.00	260.00	30	14.40	13.85	14.85	perylene D12 Confirming 1
188.00	158.00	30	7.01	6.51	7.51	phenathrene D10
188.00	160.00	30	7.01	6.51	7.51	phenathrene D10 Confirming 1
207.00	136.00	16	6.14	5.64	6.64	TCMX
244.00	209.00	16	6.14	5.64	6.64	TCMX Confirming 1
242.00	207.00	16	6.14	5.64	6.64	TCMX Confirming 2
213.89	107.95	30	4.84	4.34	5.34	Tetrachlorobenzene, 1,2,4,5 +1,2,3,5
213.89	142.93	30	4.84	4.34	5.34	Tetrachlorobenzene, 1,2,4,5 +1,2,3,5 Confirming 1
264.09	160.05	15	6.26	5.76	6.76	Trifluralin
306.10	264.09	15	6.26	5.76	6.76	Trifluralin Confirming 1
213.89	107.95	30	5.07	4.57	5.57	Tetrachlorobenzene, 1,2,3,4-
213.89	142.93	30	5.07	4.57	5.57	Tetrachlorobenzene, 1,2,3,4- Confirming 1
218.89	182.91	8	6.75	6.25	7.25	BHC-beta Confirming 1
216.89	180.91	8	6.75	6.25	7.25	BHC-beta
218.89	182.91	8	6.85	6.35	7.35	BHC-gamma (Lindane, gamma HCH) Confirming 1
216.89	180.91	8	6.85	6.35	7.35	BHC-gamma (Lindane, gamma HCH)
178.08	152.07	25	7.04	6.54	7.54	phenathrene
178.08	176.08	20	7.04	6.54	7.54	phenathrene Confirming 1
178.08	152.07	25	7.11	6.61	7.61	anthracene
178.08	176.08	20	7.11	6.61	7.61	anthracene Confirming 1
216.89	180.91	8	7.14	6.64	7.64	BHC-delta

\* Start and Stop Times are set automatically in timed-SRM mode of the TSQ 8000 by using a standard acquisition window of 60 s for all compounds

Parent Mass (Da)	Product Mass (Da)	Collision Energy (V)	RT (min)	Start Time* (min)	Stop Time* (min)	Name
218.89	182.91	8	7.14	6.64	7.64	BHC-delta Confirming 1
216.89	180.91	8	7.24	6.74	7.74	BHC-epsilon
218.89	182.91	8	7.24	6.74	7.74	BHC-epsilon Confirming 1
188.14	160.00	30	7.53	7.03	8.03	Alachlor Confirming 1
188.14	158.00	30	7.53	7.03	8.03	Alachlor
352.83	252.88	15	8.60	8.10	9.10	Heptachlor exo-epoxide (isomer B)
352.83	281.88	15	8.60	8.10	9.10	Heptachlor exo-epoxide (isomer B) Confirming 1
288.86	252.88	15	8.65	8.15	9.15	Heptachlor endo-epoxide (isomer A) Confirming 1
288.86	218.95	15	8.65	8.15	9.15	Heptachlor endo-epoxide (isomer A)
246.05	175.97	25	8.93	8.43	9.43	DDE-o,p'
317.94	245.95	20	8.93	8.43	9.43	DDE-o,p' Confirming 1
325.88	255.91	20	8.99	8.49	9.49	2,2',4,5,5'-Pentachlorobiphenyl (BZ #101) Confirming 1
323.88	253.91	20	8.99	8.49	9.49	2,2',4,5,5'-Pentachlorobiphenyl (BZ #101)
202.08	200.08	30	9.10	8.60	9.60	pyrene Confirming 1
202.08	176.08	35	9.10	8.60	9.60	pyrene
246.05	175.97	25	9.39	8.89	9.89	DDE-p,p'
317.94	245.95	20	9.39	8.89	9.89	DDE-p,p' Confirming 1
242.89	207.91	10	9.95	9.45	10.45	Endosulfan II (beta isomer) Confirming 1
240.89	205.91	10	9.95	9.45	10.45	Endosulfan II (beta isomer)
235.01	164.98	20	10.00	9.52	10.52	DDD-p,p'
237.01	164.98	20	10.00	9.52	10.52	DDD-p,p' Confirming 1
237.01	165.07	20	10.10	9.56	10.56	DDT-o,p' Confirming 1
235.01	165.07	20	10.10	9.56	10.56	DDT-o,p'
359.84	289.87	25	10.60	10.13	11.13	2,2',3,4,4',5'-Hexachlorobiphenyl (BZ #138) Confirming 1
357.84	287.88	25	10.60	10.13	11.13	2,2',3,4,4',5'-Hexachlorobiphenyl (BZ #138)
237.01	165.07	20	10.50	10.03	11.03	DDT-p,p' Confirming 1
235.01	165.07	20	10.50	10.03	11.03	DDT-p,p'
228.08	202.08	35	11.50	11.00	12.00	benzo[a]anthracene
228.08	226.08	30	11.50	11.00	12.00	benzo[a]anthracene Confirming 1
228.08	202.08	35	11.40	10.94	11.94	chrysene
228.08	226.08	30	11.40	10.94	11.94	chrysene Confirming 1
252.09	226.08	35	13.60	13.12	14.12	benzo[b]fluoranthene
252.09	250.09	30	13.60	13.12	14.12	benzo[b]fluoranthene Confirming 1
252.09	250.09	30	14.30	13.76	14.76	benzo[a]pyrene Confirming 1
252.09	226.08	35	14.30	13.76	14.76	benzo[a]pyrene
252.09	250.09	30	13.70	13.21	14.21	benzo[k]fluoranthene Confirming 1
252.09	226.08	35	13.70	13.21	14.21	benzo[k]fluoranthene
202.08	176.08	35	8.72	8.22	9.22	fluoranthene Confirming 1
202.08	200.08	30	8.72	8.22	9.22	fluoranthene
292.90	185.93	30	8.11	7.61	8.61	Aldrin
292.90	257.91	10	8.11	7.61	8.61	Aldrin Confirming 1
262.91	192.93	30	8.48	7.98	8.98	Isodrin
262.91	190.93	30	8.48	7.98	8.98	Isodrin Confirming 1
240.89	205.91	10	9.11	8.61	9.61	Endosulfan I (alpha isomer)
242.89	207.91	10	9.11	8.61	9.61	Endosulfan I (alpha isomer) Confirming 1

\* Start and Stop Times are set automatically in timed-SRM mode of the TSQ 8000 by using a standard acquisition window of 60 s for all compounds

## Addendum: SRM Transitions

Parent Mass (Da)	Product Mass (Da)	Collision Energy (V)	RT (min)	Start Time* (min)	Stop Time* (min)	Name
276.08	272.08	60	16.30	15.77	16.77	indeno[123cd]pyrene
276.08	274.08	40	16.30	15.77	16.77	indeno[123cd]pyrene Confirming 1
202.90	167.90	10	3.51	3.01	4.01	Hexachloroethane Confirming 1
117.00	82.00	25	3.51	3.01	4.01	Hexachloroethane Confirming 2
200.90	165.9	10	3.51	3.01	4.01	Hexachloroethane

\* Start and Stop Times are set automatically in timed-SRM mode of the TSQ 8000 by using a standard acquisition window of 60 s for all compounds

[www.thermofisher.com](http://www.thermofisher.com)

©2016 Thermo Fisher Scientific Inc. All rights reserved. Teflon is a registered trademark of DuPont. All other trademarks are the property of Thermo Fisher Scientific Inc. and its subsidiaries. This information is presented as an example of the capabilities of Thermo Fisher Scientific Inc. products. It is not intended to encourage use of these products in any manners that might infringe the intellectual property rights of others. Specifications, terms and pricing are subject to change. Not all products are available in all countries. Please consult your local sales representative for details.

**Africa-Other** +27 11 570 1840    **Europe-Other** +43 1 333 50 34 0    **Japan** +81 45 453 9100    **Spain** +34 914 845 965  
**Australia** +61 3 9757 4300    **Finland/Norway/Sweden** +46 8 556 468 00    **Latin America** +1 561 688 8700    **Switzerland** +41 61 716 77 00  
**Austria** +43 1 333 50 34 0    **France** +33 1 60 92 48 00    **Middle East** +43 1 333 50 34 0    **UK** +44 1442 233555  
**Belgium** +32 53 73 42 41    **Germany** +49 6103 408 1014    **Netherlands** +31 76 579 55 55    **USA** +1 800 532 4752  
**Canada** +1 800 530 8447    **New Zealand** +64 9 980 6700    **Russia/CIS** +43 1 333 50 34 0  
**China** +86 10 8419 3588    **India** +91 22 6742 9434    **South Africa** +27 11 570 1840  
**Denmark** +45 70 23 62 60    **Italy** +39 02 950 591

AN52389\_E 08/16S

**Thermo**  
**SCIENTIFIC**  
 Part of Thermo Fisher Scientific



[www.thermofisher.com](http://www.thermofisher.com)

©2014 Thermo Fisher Scientific Inc. All rights reserved. All trademarks are the property of Thermo Fisher Scientific and its subsidiaries. This information is presented as an example of the capabilities of Thermo Fisher Scientific products. It is not intended to encourage use of these products in any manners that might infringe the intellectual property rights of others. Specifications, terms and pricing are subject to change. Not all products are available in all countries. Please consult your local sales representative for details.

**Africa** +43 1 333 50 34 0

**Australia** +61 3 9757 4300

**Austria** +43 810 282 206

**Belgium** +32 53 73 42 41

**Canada** +1 800 530 8447

**China** 800 810 5118 (free call domestic)  
400 650 5118

**Denmark** +45 70 23 62 60

**Europe-Other** +43 1 333 50 34 0

**Finland** +358 9 3291 0200

**France** +33 1 60 92 48 00

**Germany** +49 6103 408 1014

**India** +91 22 6742 9494

**Italy** +39 02 950 591

**Japan** +81 45 453 9100

**Korea** +82 2 3420 8600

**Latin America** +1 561 688 8700

**Middle East** +43 1 333 50 34 0

**Netherlands** +31 76 579 55 55

**New Zealand** +64 9 980 6700

**Norway** +46 8 556 468 00

**Russia/CIS** +43 1 333 50 34 0

**Singapore** +65 6289 1190

**Spain** +34 914 845 965

**Sweden** +46 8 556 468 00

**Switzerland** +41 61 716 77 00

**UK** +44 1442 233555

**USA** +1 800 532 4752

**Thermo**  
SCIENTIFIC

A Thermo Fisher Scientific Brand