

Application Handbook

# Liquid Chromatography





---

## Introduction

---

HPLC, UHPLC as well as SFC systems are able to quantitatively analyze substances in mixtures containing multiple ingredients by separating and detecting target substances. They are used to separate, quantify, qualify or purify single components from a sample containing various analytes in different matrices. Shimadzu offers a wide variety of application-specific systems, such as automated sample pretreatment systems for amino acid analysis or on-line sample trapping for the quantification of residual pesticides in food or soil.

Find more information on:  
[www.shimadzu.eu/liquid-chromatography](http://www.shimadzu.eu/liquid-chromatography)



# Contents

## 1. Clinical

---

Nexera UC SFE-SFC  
Nexera X2-RF  
Nexera-e (2D LC)  
Nexera-i

## 2. Environmental

---

Nexera UC SFE-LCMS/MS  
Prominence-i  
Prominence-i RF  
Prominence-UV

## 3. Food, Beverages & Agriculture

---

Nexera UC SFE-GCMS  
Nexera UC SFE-SFC  
Nexera X2-PDA  
Nexera X2-RF  
Nexera-e (2D LC)  
Nexera-i RF  
Prominence-i  
Prominence-i RID  
Prominence-PDA  
Prominence-RF

## 4. Pharmaceutical

---

Co-Sense for Impurities  
Nexera UC SFC  
Nexera UC SFE-SFC  
Nexera X2-PDA  
Nexera X2-RID  
Nexera X2-UV  
Nexera-i  
Prominence-i  
Prominence-UV



# 1. Clinical

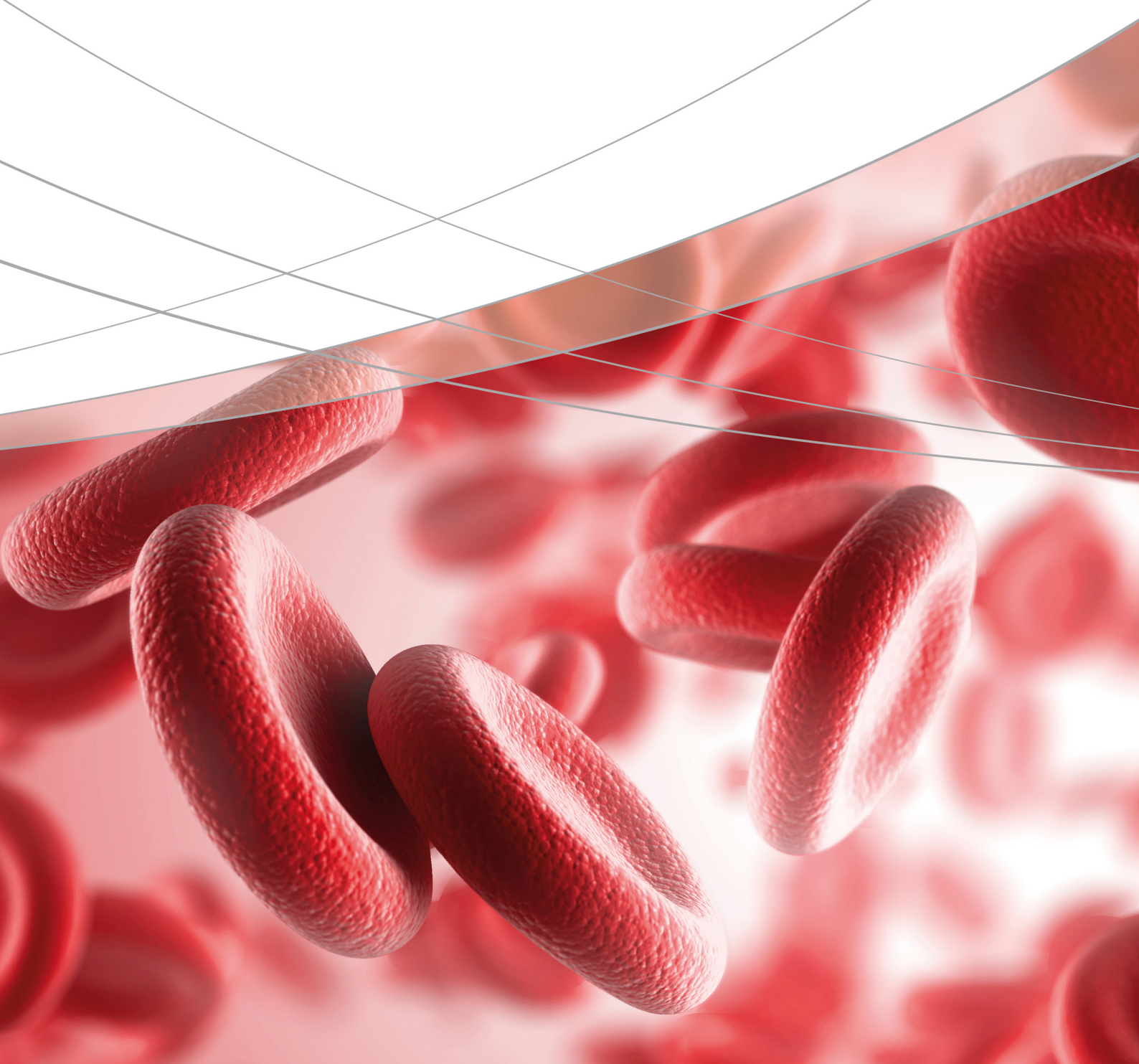



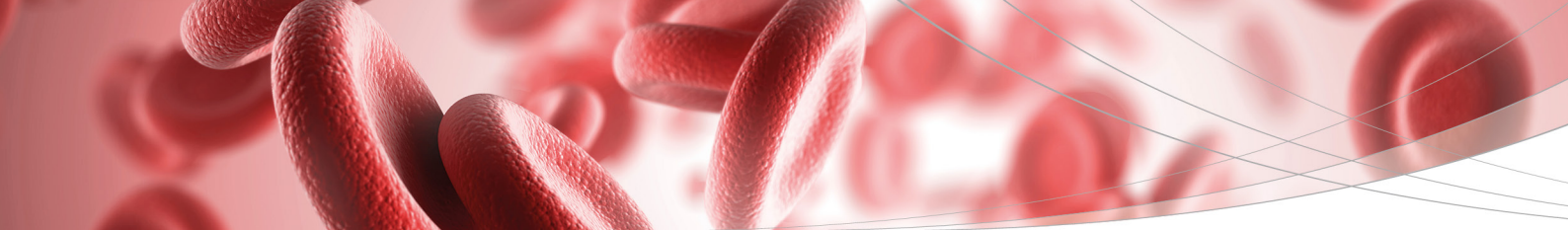

---

## 1. Clinical

---

The analysis of whole blood, plasma, serum and urine is a most insightful method in clinical research. Since the sensitivity of analytical instrumentation has improved steadily in recent years, research results and reliability have increased as well.

In clinical applications, analytical instruments unfold a multitude of benefits:

- They support the quality of life by optimizing the treatment plan. Therapeutic Drug Monitoring (TDM) can assure the plasma concentration of a medication which is affected by age or health and also depends on gender, genetic constitution and drug regimen.
- They help to save lives, particularly when it comes to time-critical situations, e.g. acute intoxication.
- They enable the identification of over- and undersupply of vitamins, minerals and trace elements.
- They are applied in critical research in genomics, proteomics and metabolomics.
- They support the uncovering of fraud in sports by detecting doping agents in blood or urine.

Clinical applications benefit from Shimadzu's complete portfolio covering chromatography and mass spectrometry (GC, GC-MS, GC-MS/MS, HPLC, UHPLC, LC-MS, LC-MS/MS), spectroscopy (UV-VIS, FTIR, AAS, EDX, ICP-OES), life sciences (MALDI-(TOF)-MS), microchip-electrophoresis, drug delivery, and a wide range of medical equipment.

Shimadzu breaks new ground by rethinking the use of mature technologies to develop new unique systems, such as the iMScope TRIO. It combines an optical microscope with a mass spectrometer for insights on the molecular level. For next-generation brain science, Shimadzu provides LABNIRS, an imaging technology for visualization of brain functions by functional near-infrared spectroscopy (fNIRS).

Find more information on: [www.shimadzu.eu/clinical](http://www.shimadzu.eu/clinical)

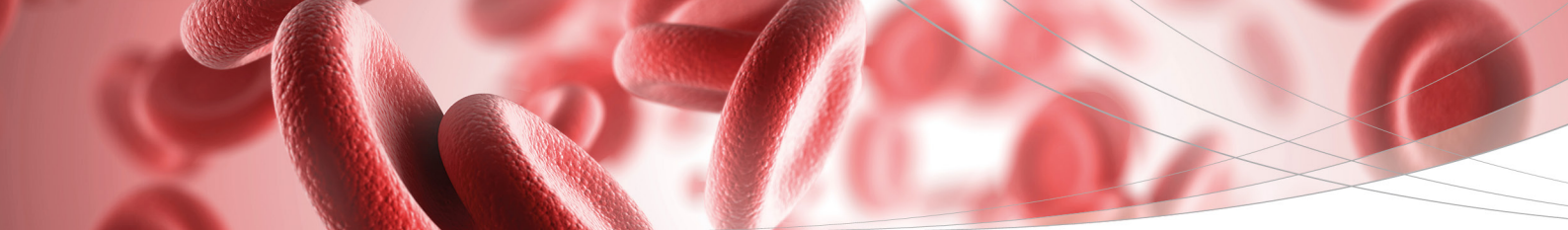

---

## 1. Clinical

---

### **Nexera UC SFE-SFC**

L496                      Analysis of unstable compounds using  
online SFE-SFC

### **Nexera X2-RF**

21                              High-speed, sensitive analysis of serotonin  
L452A                      High sensitivity profiling of glycans in anti-  
body drugs using RF-20AXS  
L458                              Analysis of pre-column derivatized amino  
acids in proteins

### **Nexera-e (2D LC)**

C190-E176                      Online comprehensive RPLCxRPLC /IT-TOF  
for proteome isoforms  
C190-E181                      Stop-flow comprehensive 2D-LCMS for  
analysis of phospholipids  
L462                              Glycerophospholipids analysis by com-  
prehensive HPLC coupled with a triple  
quadrupole mass spectrometer

### **Nexera-i**

L488                              Peptide mapping of antibody drugs by  
Nexera-i

# Application News

## No.L496

### Supercritical Fluid Extraction / Chromatography

## Analysis of Unstable Compounds Using Online SFE-SFC

Supercritical fluids have characteristics of both gas and liquid; low viscosity, high diffusivity and solubility. In particular, carbon dioxide becomes a supercritical fluid at a relatively modest critical point (31.1 °C and 7.38 MPa). Due to its low toxicity, inertness, easy availability, and low cost, supercritical carbon dioxide fluid is used in a wide variety of fields. Analytical applications using it include supercritical fluid extraction (SFE) and supercritical fluid chromatography (SFC).

Previously SFE and SFC were offline operations for pretreatment or analysis, respectively, and treated as completely separate workflows. However, now SFE and SFC can be connected online using the Nexera UC system, which allows integration of all the processes from pretreatment to data acquisition into a single workflow. This article describes using the Nexera UC system for online SFE-SFC analysis.

#### ■ Online SFE-SFC

A flow diagram of online SFE-SFC analysis is shown in Fig. 1. Online SFE-SFC involves online introduction of components extracted from an extraction vessel using supercritical fluid to an SFC analytical column, where they are separated and then detected accordingly. The entire process, from extraction to data acquisition, is performed by switching flow lines using a valve inside the SFE unit. Two types of extraction operations are involved. After supercritical fluid is introduced to the extraction vessel, static extraction is performed where components are extracted while fluid flow is stopped. Then dynamic extraction is done to extract components while pumping fluid through the extraction vessel. In the case of online SFE-SFC, the sample is transported through the analytical column during dynamic extraction. Consequently, the entire online SFE-SFC process, from extraction to separation and detection, can be completed

within a single system, which eliminates the need for any complicated pretreatment processes and enables automation. That can significantly reduce the time and effort required for the various operations involved in the analysis.

It also means that the entire process, from extraction to separation and detection, can be performed without exposure to light, without oxidation, and in a moisture-free environment. Therefore, the method is extremely useful for analyzing unstable compounds, such as compounds with components easily decomposed by light, easily oxidized, or easily hydrolyzed. Unlike offline SFE, online SFE-SFC eliminates need for preparing sample solutions, which means it eliminates possibility of dilution of target components by the sample solvent, thus providing an easy way of increasing sensitivity.

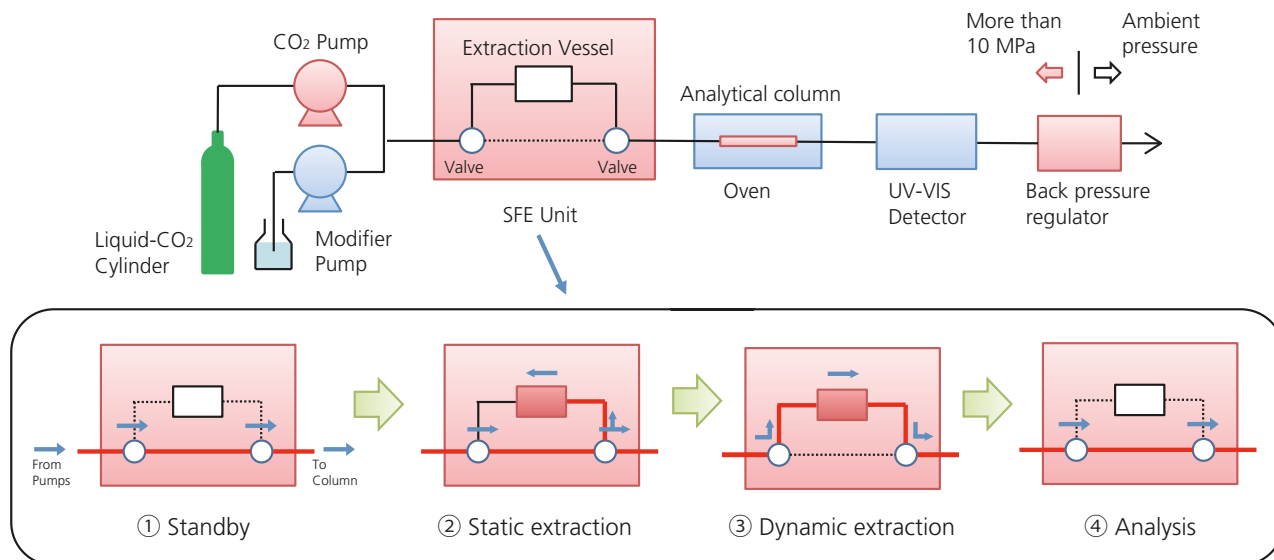

Fig. 1 Process Flow Diagram of Online SFE-SFC System



■ Online SFE-SFC Analysis of Reduced Coenzyme Q10

Fig. 2 shows the structure of the reduced coenzyme Q10 (ubiquinol). It is easily oxidized to form oxidized coenzyme Q10 (ubiquinone). In this case, both solvent extraction-SFC and online SFE-SFC were used to analyze the reduced coenzyme Q10 contained in a supplement capsule.

Pretreatment operations and analytical conditions for the solvent extraction-SFC analysis are indicated in Fig. 3 and Table 1.

Chromatograms from analyzing the supplement and the oxidized coenzyme Q10 standard sample are shown in Fig. 4.

Table 1 Analytical Conditions for Solvent Extraction-SFC

System	: Nexera UC SFC-UV System
Column	: Shim-pack UC-RP (150 mm L. x 4.6 mm I.D., 3 μm)
Column Temp.	: 40 °C
Modifier	: MeOH
Flowrate	: 3 mL/min
Time Program	: 5 % (0 min) → 50 % (5 - 8 min)
BPR	: 10 MPa
Detector	: UV-VIS (220 nm)
Inj. Vol.	: 1 μL

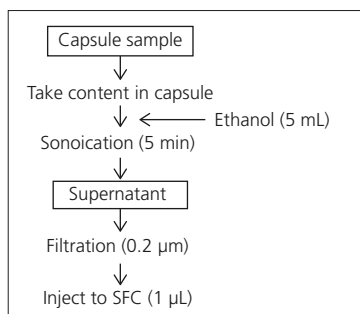

Fig. 3 Pretreatment

Analytical conditions for online SFE-SFC are indicated in Table 2.

About 5 μL each of the liquid sealed inside the supplement capsule and the standard sample of oxidized coenzyme Q10 were dripped onto filter paper. Then a portion of the filter paper was cut with a punch-out device and placed in the extraction vessel for analysis by online SFE-SFC. Chromatograms from analyzing the supplement and the oxidized coenzyme Q10 standard sample are shown in Fig. 5.

Table 2 Analytical Conditions for Online SFE-SFC

System	: Nexera UC Online SFE-SFC-UV System
<b>SFE</b>	
Extraction Vessel	: 0.2 mL
Static Extraction	: Time ; 0 - 2 min, : B.Conc. ; 5 % : BPR ; 10 MPa
Dynamic Extraction	: Flowrate ; 3 mL/min
Dynamic Extraction	: Time ; 2 - 4 min, : B.Conc. ; 5 % : BPR ; 10 MPa
Dynamic Extraction	: Flowrate ; 3 mL/min
<b>SFC</b>	
Column	: Shim-pack UC-RP (150 mm L. x 4.6 mm I.D., 3 μm)
Column Temp.	: 40 °C
Mobile Phase	: A; CO <sub>2</sub> : B; MeOH
Flowrate	: 3 mL/min
Time Program	: 5 % (4 min) → 50 % (9 - 13 min)
BPR	: 10 MPa
Detector	: UV-VIS (220 nm)

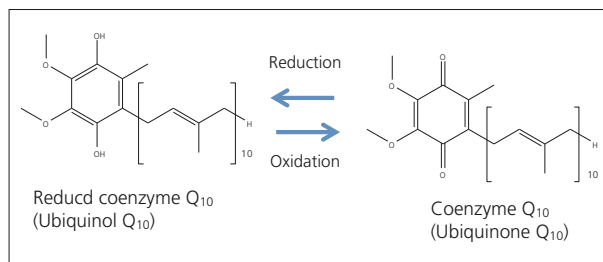

Fig. 2 Structural Formulas

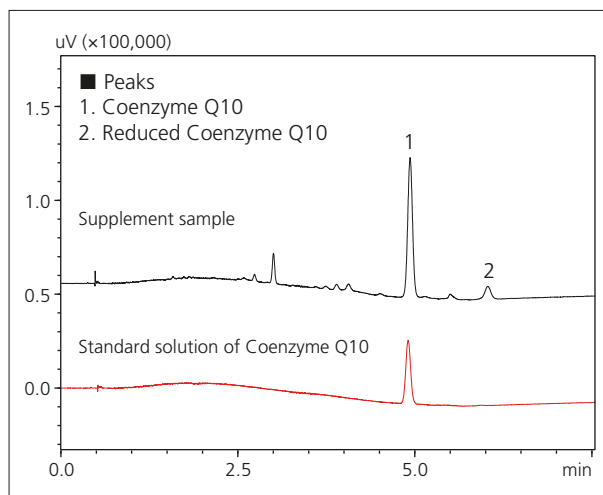

Fig. 4 Chromatograms Obtained by Solvent Extraction-SFC

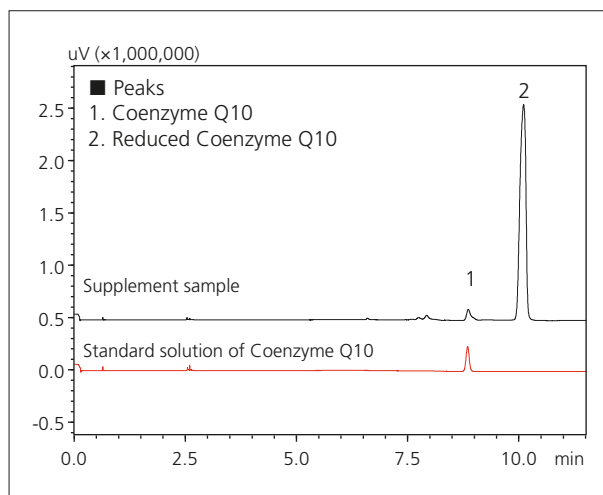

Fig. 5 Chromatograms Obtained by Online SFE-SFC

The results show that the coenzyme Q10 was oxidized during extraction with solvent extraction-SFC, but not oxidized and remained as the reduced coenzyme Q10 form throughout extraction, separation, and detection steps with online SFE-SFC. This shows how online SFE-SFC is an extremely unique analytical technique that can be used to analyze unstable compounds without altering their original form.

Serotonin (5-hydroxytryptamine) is a biologically active substance that plays an important role in the body, functioning in the blood to constrict the vascular smooth muscle, and to promote platelet aggregation. This article introduces an example of ultrafast analysis of serotonin in the blood utilizing the Nexera UHPLC system and the RF-20Axs high-sensitivity fluorescence detector.

### Analysis of Serotonin in the Blood

The blood sample was subjected to deproteinization via an aqueous trichloroacetic acid solution. A Shim-pack XR-ODS III (2 mm internal diameter, 50 mm length) with a 1.6  $\mu\text{m}$  particle size was used, and detection was performed via the RF-20Axs fluorescence detector. The maximum system load pressure in this analysis was approximately 79 MPa.

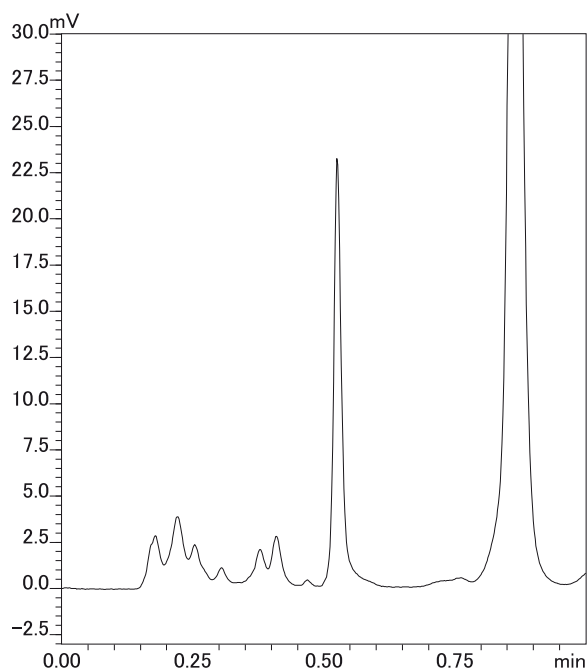

Column	: Shim-pack XR-ODS III (50 mmL. x 2.0 mmI.D., 1.6 $\mu\text{m}$ )
Pressure	: 79 MPa
Mobile Phase	: 0.15 mmol/L Acetate buffer (pH 4.7) / Methanol = 9 / 1 (v / v)
Flow Rate	: 0.7 mL/min
Column Temp.	: 37 °C
Injection Volume	: 1 $\mu\text{L}$
Detection	: Fluorescence (RF-20Axs) Ex. 300 nm, Em. 350 nm
Cell Temp.	: 25°C
Flow Cell	: Semi-micro cell

Peak :  
1. Serotonin

\* This data was provided by BML, Inc.

\* The data in this document was not acquired by instruments approved by the Japanese Pharmaceutical Affairs Law.

# Application News

## No.L452A

### High Performance Liquid Chromatography

## High Sensitivity Profiling of Glycans in Antibody Drugs Using RF-20A<sub>XS</sub>

Glycans, or sugar chains, in antibody drugs play roles in the antigenicity, pharmacokinetics, and stability of higher-order structure, which could adversely affect their safety and effectiveness. Further, there is also concern about the non-uniformity of these glycans due to instability of antibody drug culture conditions, which has heightened the necessity to manage their production process. However, while there is currently no glycan test method specified in the Japanese Pharmacopoeia, there is wide demand for an assessment method.

Here, we introduce an example of analysis of glycans in antibody drugs using the Nexera X2 ultra high performance liquid chromatograph with the RF-20A<sub>XS</sub> high-sensitivity fluorescence detector. For the analysis, the Phenomenex core-shell, high-speed analytical Aeris™ PEPTIDE XB-C18 column was used. Since the permeability of the packing material is optimized for analysis of high-molecular compounds such as peptides, the column is useful for separation of glycans and impurities in antibody drugs.

### ■ Sensitivity and Linearity of Detectors in PA-Glycan Analysis

The sensitivity and linearity of the RF-20A<sub>XS</sub> fluorescence detector was evaluated using a pyridylamino (PA)-glycan (PA-Sugar Chain 009, Takara Bio Inc.). Table 1 shows the analytical conditions.

Fig. 1 shows a comparison of the sensitivity obtained in analysis of a PA-glycan at 10 fmol (5 nmol/L, 2 μL injected) using the fluorescence detectors RF-20A<sub>XS</sub> and the previous model RF-10A<sub>XL</sub> connected in series. Excellent results were obtained with the RF-20A<sub>XS</sub>, with a good S/N ratio and low noise.

Fig. 2 shows the calibration curve results obtained with the RF-20A<sub>XS</sub> fluorescence detector over a concentration range of 1 – 100 fmol (0.5 – 50 nmol/L, 2 μL injected). There is significant improvement in performance compared to the previous model, and these results demonstrate that the RF-20A<sub>XS</sub> fluorescence detector is suitable for verification not only of the main peak, but of the trace level impurities as well.

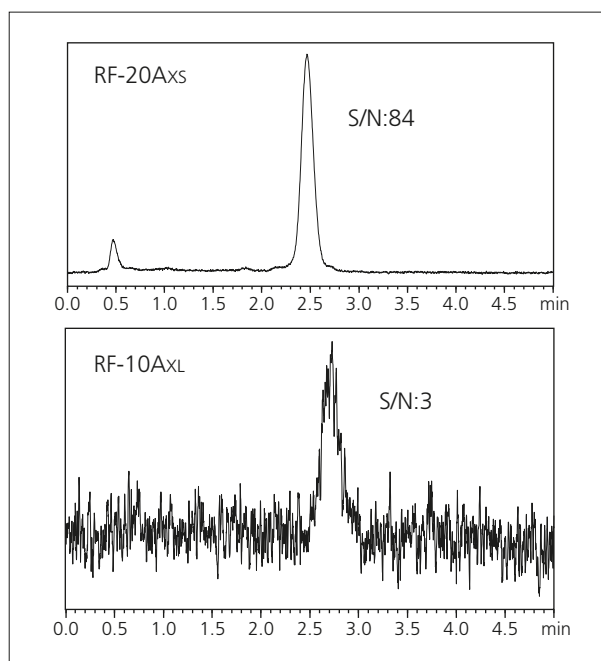

Fig. 1 Chromatograms of 10 fmol PA-Glycan

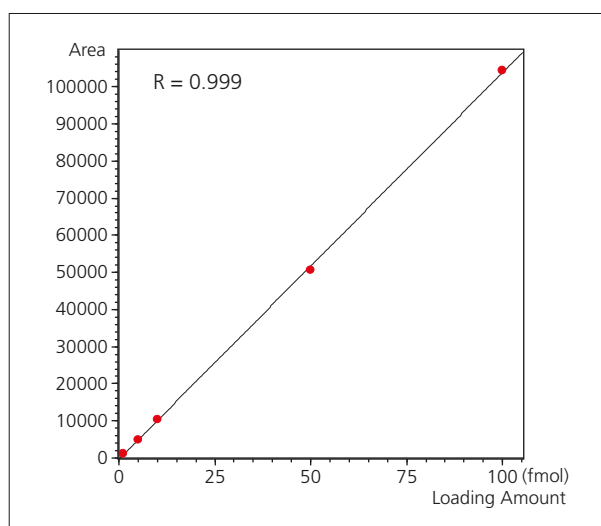

Fig. 2 Calibration Curve (1 – 100 fmol Injected)

Table 1 Analytical Conditions

Instrument	: Nexera X2
Column	: Shim-pack XR-ODS III (50 mm L. × 2.0 mm I.D., 1.6 μm)
Mobile Phase*	: A) 20 mmol/L Ammonium Formate 0.0095% (v/v) Formic Acid-Water (pH 4.5)
	: B) 20 mmol/L Ammonium Formate 0.0095% (v/v) Formic Acid-Methanol
	: A/B=95/5 (v/v)
Flowrate	: 0.5 mL/min
Column Temp.	: 40 °C
Detection	: RF-20A <sub>XS</sub> (Ex = 320 nm, Em = 400 nm)
Injection Vol.	: 2 μL

\*Mobile Phase Preparation

1.26 g (20 mmol) ammonium formate (M.W.: 63.026) was dissolved in 1 L of distilled water or methanol, and 95 μL of formic acid was added.



### ■ Analysis of Glycans in Antibody Drugs

According to the pretreatment procedure of Fig. 3, the glycans were extracted from 2 types of antibody drugs, and following purification, were subjected to fluorescent derivatization by PA (pyridylamination).

Fig. 4 shows the chromatograms of PA-glycans from antibody drugs, and Table 2 shows the analytical conditions used. Comparing the peaks in the vicinity of 50 minutes for the drugs A and B, respectively, the quantity of glycans associated with that peak in antibody drug A is much greater than that in drug B. The peak response is quite different for many other peaks, which illustrates the formulation differences between drug manufacturers.

**Table 2 Analytical Conditions**

Instrument	: Nexera X2
Column	: Aeris™ PEPTIDE XB-C18 (150 mm L. × 2.1 mm I.D., 1.7 μm)
Mobile Phases	: A) 20 mmol/L Ammonium Formate 0.0095 % (v/v) Formic Acid-Water (pH 4.5) B) 20 mmol/L Ammonium Formate 0.0095 % (v/v) Formic Acid-Methanol
Time Program	: B Conc. 0 % (0 min) → 5 % (60 min) → 10 % (70 min) → 100 % (70.01 min → 80 min) → 0 % (80.01 min → 90 min)
Flowrate	: 0.4 mL/min
Column Temp.	: 40 °C
Detection	: RF-20Axs (Ex = 320 nm, Em = 400 nm)
Injection Vol.	: 3 μL

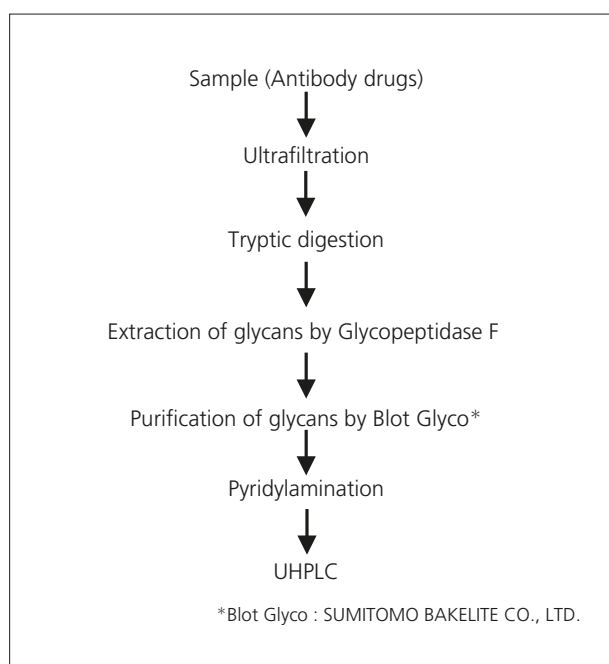

**Fig. 3 Sample Preparation**

Analysis of the glycans in the antibody drugs was conducted with the kind cooperation of Kenichiro Todoroki, Ph.D. of the Laboratory of Analytical and Bio-Analytical Chemistry, School of Pharmaceutical Sciences, University of Shizuoka.

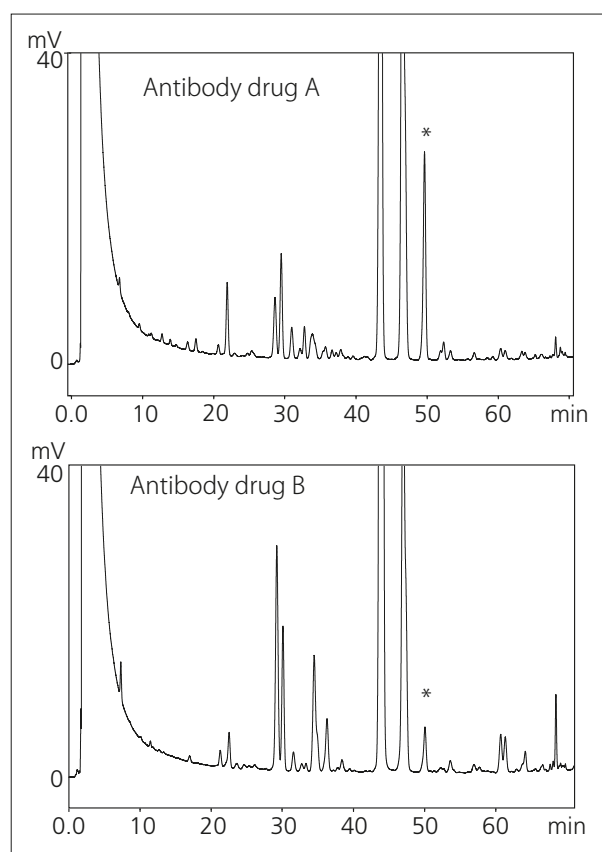

**Fig. 4 Chromatograms of PA-Glycans from Antibody Drugs**

For further information regarding the Aeris™ column, please contact

**Shimadzu GLC Ltd.**

TEL: +81-3-5835-0126, gsupport@glc.shimadzu.co.jp

# Application News

## No. L458

### High Performance Liquid Chromatography

## High Speed, High Resolution Analysis (Part 47) Analysis of Pre-Column Derivatized Amino Acids by the Nexera SIL-30AC Autosampler (Part 3)

Amino acid composition analysis has traditionally been conducted for protein quantitation and peptide structure prediction. Its use has also extended in recent years to the quantitation of such functional components as branched chain amino acids (BCAA). Previously, in Application News No. L432 and L437, we introduced examples of analysis of amino acids subjected to fluorescence derivatization using *o*-phthalaldehyde (OPA) using the SIL-30AC. Here, we introduce an example of fast analysis of amino acids in proteins.

### ■ Simultaneous Determination of 17 Amino Acids

This method utilizes the pretreatment functions of the Nexera SIL-30AC to automatically derivatize amino acid samples with OPA. The sample rack is set up with the underivatized samples in one section and empty vials in another section that will contain the sample and reagent(s) delivered by the SIL-30AC prior to injection. Table 1 shows the derivatizing reagents used with this method. Fig. 1 shows the chromatogram obtained from measurement of a standard mixture of seventeen amino acids in solution using the analytical conditions shown in Table 2. The total analysis time can be shortened by using the overlapping injection feature that was described in Application News No. L437. This feature permits derivatization and injection preparation of the sample to follow the sample that is currently being analyzed.

**Table 1 Derivatization Reagents**

• Mercaptopropionic Acid 3-Mercaptopropionic Acid 10 µL in 0.1 mol/L Borate Buffer (pH9.2) 10 mL
• <i>o</i> -phthalaldehyde - Ethanol Solution <i>o</i> -Phthalaldehyde 10 mg in 0.1 mol/L Borate Buffer (pH9.2) 5 mL
• Fluorenyl Methyl Chloro Formate - Acetonitrile Solution 9-Fluorenyl Methyl Chloro Formate 4 mg in Acetonitrile 20 mL

**Table 2 Analytical Conditions**

Column	: YMC-Triart C18 1.9 µm (50 mm L. × 3.0 mm I.D., 1.9 µm, YMC CO., LTD.)
Mobile Phase	: A: 20 mmol/L Phosphate Potassium Buffer (pH 6.2) B: 60/40 Acetonitrile/Methanol
Time Program	: Gradient Elution
Flowrate	: 1.2 mL/min
Column Temp.	: 40 °C
Injection Volume	: 1 µL
Detection	: RF-20A <sub>XS</sub> Ex. at 350 nm, Em. at 450 nm → Ex. at 266 nm, Em. at 305 nm (8.5 min)
Cell Temp.	: 30 °C
Flow Cell	: Conventional Cell

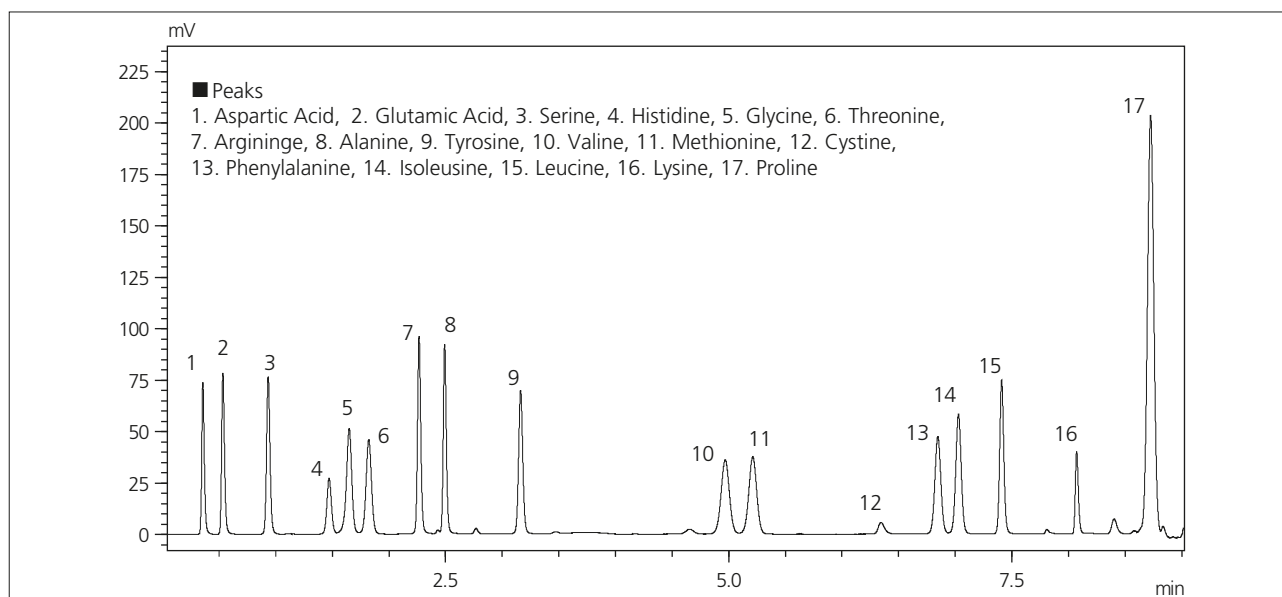

**Fig. 1 Chromatogram of 17 Amino Acids in Standard Solution (25 µmol/L each)**

### ■ Analysis of Angiotensin I Hydrolysate

Angiotensin is a polypeptide that exhibits vasoconstriction activity to increase blood pressure. There are four types of angiotensin, types I - IV, that differ in the numbers and types of amino acids in their structures.

The structure of angiotensin I consists of a total of ten amino acid residues, including aspartic acid, arginine, valine, tyrosine, isoleucine, proline, phenylalanine, leucine, and two molecules of histidine. In response to the action of angiotensin-converting enzyme (ACE), angiotensin I is converted to angiotensin II, which exhibits greater vasopressor activity.

After adding 500  $\mu$ L of 6 mol/L hydrochloric acid (ICP grade) to 0.5 mg of angiotensin I, the mixture was set aside for 22 hours in a reduced pressure atmosphere at 110  $^{\circ}$ C to permit complete hydrolysis.

The liquid phase was then evaporated under a stream of nitrogen gas to obtain a dry residue. The residue was then re-dissolved in 10 mL of 0.1 mol/L borate buffer for use as the sample.

The analysis results are shown in Fig. 2. Two molecules of histidine were detected while one molecule each of the other amino acids was detected, which matched the actual amino acid sequence.

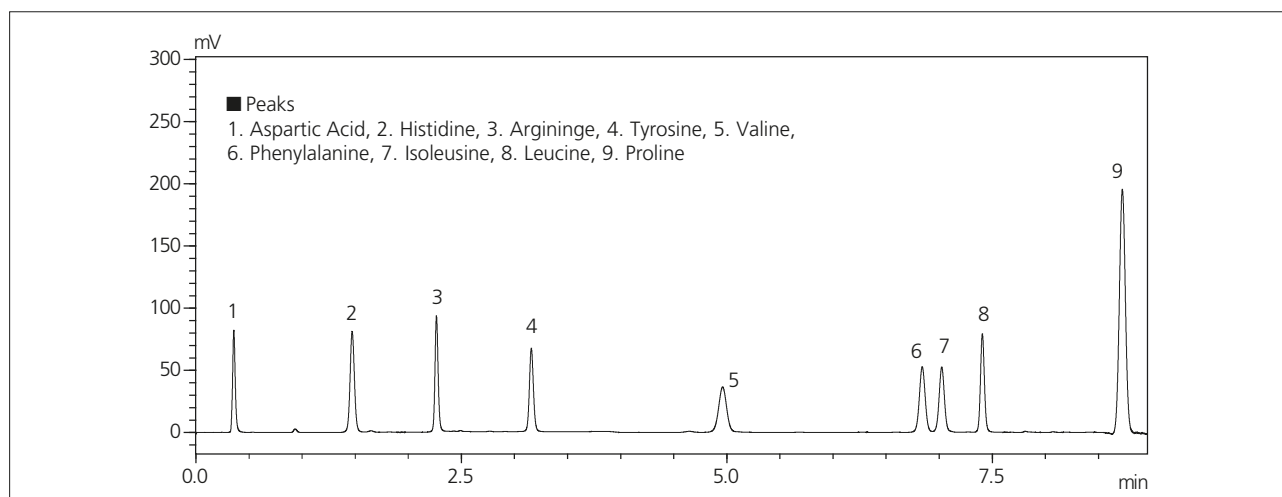

Fig. 2 Chromatogram of Angiotensin I Hydrolysate

### ■ Analysis of Bovine Serum Albumin Hydrolysate

Bovine serum albumin is a protein that is often used in biochemical experiments. In this example, after adding 500  $\mu$ L of 6 mol/L hydrochloric acid (ICP grade) to 3.5 mg of bovine serum albumin, the mixture was placed in a reduced pressure atmosphere at 110  $^{\circ}$ C for 22 hours to permit complete hydrolysis.

The liquid phase was then evaporated under a stream of nitrogen gas to obtain a dry residue. The residue was then re-dissolved in 10 mL of 0.1 mol/L borate buffer for use as the sample. The results of analysis are shown in Fig. 3.

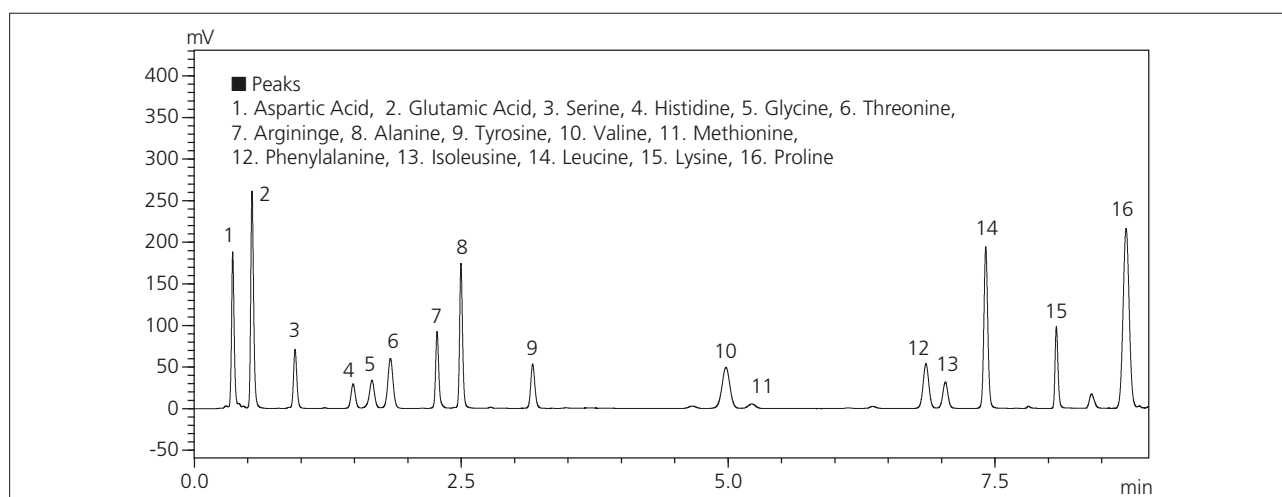

Fig. 3 Chromatogram of Bovine Serum Albumin Hydrolysate



# Technical Report

## On-line Comprehensive RP-LC×RP-LC/IT-TOF for the Analysis of Proteome Isoforms

A meaningful evaluation tool for native and recombinant proteins

Paola Donato<sup>1</sup>, Francesco Cacciola<sup>1</sup>, Paola Dugo<sup>1,2</sup>, Luigi Mondello<sup>1,2</sup>

### Abstract:

This bottom-up approach relies on both the power of 2D-LC separation techniques, and the sensitivity of MS (ESI-IT-TOF) detection. After separation by RP-LC×RP-LC is performed at the peptide level, both PDA and MS 2D plots are obtained by means of a dedicated software, which further allows qualitative and quantitative data analysis, as well as spectral comparison/subtraction. Tandem MS data obtained by collision-induced dissociation (CID) of the peptides were used for database search for  $\alpha$ -casein and dephosphorylated  $\alpha$ -casein, with high sequence coverage.

**Keywords:** RP-LC×RP-LC-PDA-IT-TOF, tryptic digest, proteome analysis, protein isoforms

## 1. Introduction

The analysis of complex biochemical systems, such as proteins and peptides isolated from tissues, cells, and body fluids has always represented a major task for analytical chemistry. A high demand is in fact placed both on the power of separation techniques, given the extremely high complexity of the proteome samples, and on the sensitivity of detection methods, to enable probing of low abundant proteins or peptides. Different strategies have been developed attempting to address the needs of modern proteomics, increase the overall throughput of proteomics experiments, and facilitate researchers to investigate into the complicated biological networks in which proteins are involved, at different levels.

For many years, two-dimensional polyacrylamide gel electrophoresis (2D-PAGE) followed by mass spectrometry (MS) has been the workhorse in analytical proteomics, its major drawbacks consisting in difficulty of automation, low accessibility of membrane-bound proteins, problematic detection of proteins with large molecular weight, high pI, strong hydrophobicity, or low abundance<sup>[1-4]</sup>. Over the last decade, considerable effort has been put in the development of ultra-high efficiency liquid chromatographic (LC) methodologies, pushing gel-free separation techniques to evolve beside the more troublesome and tedious 2D-PAGE experimental designs. 2D separation set-ups based on RP-LC are characterized by superior

resolution and peak capacity, more homogeneous distribution of peptides elution in the separation window, robustness and easy handling<sup>[5, 6]</sup>.

This technical report describes the first comprehensive 2D LC system, in which the on-line coupling of RP-LC×RP-LC to MS (IT-TOF) is investigated (Fig. 1). The two dimensions consisted both of a novel fused-core stationary phase specifically designed for peptide separation, interfaced through an electronically activated 2-position, ten-port valve. The performance of the system was assessed by means of tryptic mapping (protein unfolding, trypsin digestion, and reversed-phase chromatography of the peptide samples), followed by ESI MS characterization of  $\alpha$ -casein and dephosphorylated  $\alpha$ -casein (Fig. 2).

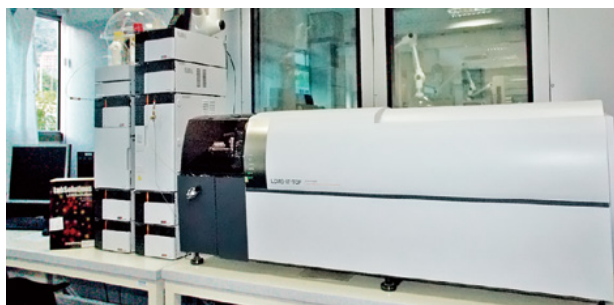

Fig. 1 LCxLC instrumentation with PDA and LCMS-IT-TOF detection

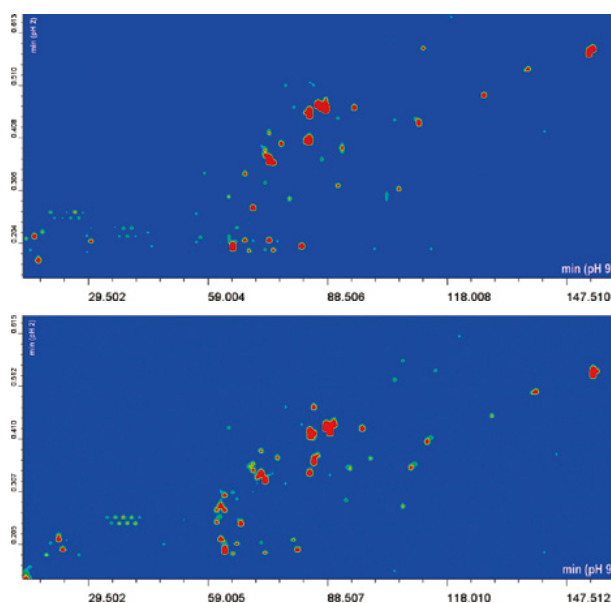

Fig. 2 Plots:  $\alpha$ -casein (top) and dephosphorylated  $\alpha$ -casein (bottom) tryptic digests

<sup>1</sup> University of Messina, Italy  
<sup>2</sup> Chromaleont S.r.l.

## 2. Experimental

### 2-1. Instrument

- Shimadzu CBM-20A controller
- Shimadzu LC-20AD dual-plunger parallel-flow pumps (D1-LC)
- Shimadzu LC-20AB solvent delivery module (D2-LC)
- Shimadzu DGU-20As degassing unit
- Shimadzu CTO-20A column oven
- Shimadzu SIL-20A autosampler
- Shimadzu SPD-M20A photo diode array detector (8  $\mu\text{L}$  flow cell)
- Shimadzu LCMS-IT-TOF (ESI source)

For connecting the two dimensions: electronically-controlled 2-position, ten-port high pressure switching valve (with two 100  $\mu\text{L}$  sampling loops), Fig. 3.

### 2-2. Software

- Shimadzu LCMSolution (Version 3.50.346)

### 2-3. 2D Software

- ChromSquare (Version 2.0) from Chromaleont, Messina, Italy

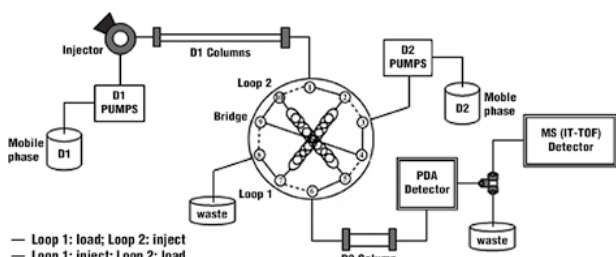

Fig. 3 Schematic of the 2D system and the switching valve

### 2-4. Chromatographic Methods

#### First dimension (Reversed-phase)

Column	: Ascentis Express Peptide ES-C18, 150 mmL. $\times$ 2.1 mmL.D., 2.7 $\mu\text{m}$ d.p. (Sigma-Aldrich/Supelco, Bellefonte, PA, USA)
Mobile phase	: (A) 10 mM $\text{CH}_3\text{COONH}_4$ in $\text{H}_2\text{O}$ (pH 9) (B) 10 mM $\text{CH}_3\text{COONH}_4$ in $\text{H}_2\text{O}/\text{ACN}$ 10:90 (pH 9)
Gradient	: 0–40 min, 0 to 10% B, 40–60 min, to 20% B, 60–200 min, to 50%, 200–220 min, to 100% B (hold for 20 min)
Flow rate	: 100 $\mu\text{L}/\text{min}$
Column oven	: 35 $^\circ\text{C}$
Injection vol.	: 20 $\mu\text{L}$

#### Second dimension (Reversed-phase)

Column	: Ascentis Express Peptide ES-C18, 30 mmL. $\times$ 4.6 mmL.D., 2.7 $\mu\text{m}$ d.p. (Sigma-Aldrich/Supelco, Bellefonte, PA, USA)
Mobile phase	: (A) 0.1% TFA in $\text{H}_2\text{O}$ (pH 2) (B) 0.1% TFA in $\text{H}_2\text{O}/\text{ACN}$ 10:90 (pH 2)
Gradient	: 0–0.05 min, 0 to 20% B, 0.05–0.40 min, to 40% B, 0.40–0.50 min, to 50% B, 0.50–0.69 min, to 90% B, 0.69–0.70 min, to 0% B, 0.70–1.00 min, to 0% B
Flow rate	: 4 mL/min
Column oven	: 35 $^\circ\text{C}$
Modulation time	: 1 min
Loop size	: 100 $\mu\text{L}$

### 2-5. Detection

PDA wavelength: 215 nm; sampling rate 12.5 Hz; time constant 0.080 sec. LCMS-IT-TOF: ESI positive mode; flow from the LC system 180  $\mu\text{L}/\text{min}$ ; detector voltage 1.60 kV; CDL temperature 200  $^\circ\text{C}$ ; block heater temperature 200  $^\circ\text{C}$ ; nebulizing gas flow ( $\text{N}_2$ ) 1.5 L/min; ion accumulation time 40 msec; full scan 200–2000  $m/z$ ; repeat 3; ASC 70%.

### 2-6. Sample Preparation

Tryptic digestion was made according to Bushey and Jorgeson<sup>[7]</sup>: one-tenth gram of  $\alpha$ -casein or dephosphorylated  $\alpha$ -casein were dissolved in 10 mL of 0.01 M  $\text{HCOONH}_4$  buffer, and the pH adjusted to 8.0 with  $\text{NH}_4\text{OH}$ ; the solution was heated in a boiling water bath for 6 min. After the solution cooled, 2.0 mg of trypsin from bovine pancreas was added, and the mixture was allowed to react for 4 h at +37  $^\circ\text{C}$ ; the reaction was quenched by adding 0.1% TFA to pH 2. The digests were stored at +4  $^\circ\text{C}$ , and filtered prior to injection through 0.45  $\mu\text{m}$  nylon membrane (Whatman).

Aqueous solutions of the peptide standard mixture were prepared at 100 ppm.

## 3. Results and Discussion

Parameters for MS detection were optimized using a mixture of five standard peptides, and the results in terms of mass accuracy are reported in Table 1. The chromatographic separation was first optimized in the two dimensions, separately. In order to enhance the separation power, four narrow-bore columns have been serially coupled in the D1, achieving a theoretical peak capacity of 402. Peptides were eluted from the first dimension with basic mobile phase (pH 9).

Table 1 Mass accuracy for the LCMS-IT-TOF analysis of a standard peptide mixture

AA sequence	Monoisotopic mass	Predicted $[\text{M}+\text{H}]^+$	Measured $[\text{M}+\text{H}]^+$	Error (amu)	Error (ppm)
GLY-TYR (1)	238.0954	239.10333	239.1023	-0.00103	4.30
VAL-TYR-VAL (2)	370.21079	380.2186	380.2164	-0.00229	6.02
TYR-GLY-GLY-PHE-MET (3)	573.22579	574.23369	574.23340	+0.00031	0.53
TYR-GLY-GLY-PHE-LEU (4)	555.26936	556.27726	556.2767	-0.0056	1.00
ASP-ARG-VAL-TYR-ILE-HIS-PRO-PHE (5)	1045.53457	1046.54247	1046.5457	+0.00323	3.08

The D2 column consisted of RP-LC, due to its straightforward linkage to MS detection, and was operated at low pH, attempting to deliver a certain degree of orthogonality to D1. In the D2 separation, all the peaks eluted within 0.6 min, allowing enough time space for re-conditioning (Fig. 4).

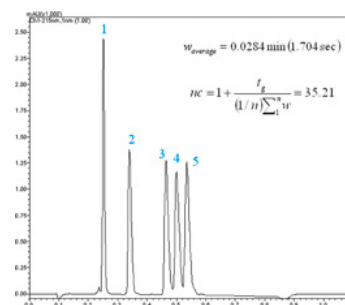

Fig. 4 One-min D2 separation of a standard peptide mixture

### 3-1. Tryptic Mapping and MS Characterization

The contour plot obtained for the comprehensive RP-LC×RP-LC-PDA-IT-TOF analysis of  $\alpha$ -casein and dephosphorylated  $\alpha$ -casein is shown in Fig. 2. Replicate analyses ( $n = 3$ ) of the digests were run on the 2D system, and reproducibility of the retention times was calculated for five selected peaks spread throughout the elution window, yielding an average CV% of 0.555 (averaged CV% in the two chromatographic dimensions).

The overall peak capacity of the comprehensive separation was calculated as 8540, being multiplicative of the individual values obtained for the two dimensions ( $n_1 \times n_2$ ). These values are merely theoretical, however, any effect of the first dimension undersampling (about 1 fraction per peak capacity), nor the selectivity correlation (orthogonality), or the retention window in both dimensions, which does not cover the whole gradient duration. Therefore, some adjustments were made, in the calculation, which are fundamental for realistic peak capacity calculations.

First, the practical peak capacity of the separation, which accounts for orthogonality between the two dimensions (retention correlation derived from solute retention vectors), was calculated using the equation developed by Liu *et al.*<sup>[9]</sup>. This calculation is based on solute retention parameters and, therefore, is more accurate in describing resolving power than those calculated by the multiplicative rule. A value of 3982 was obtained.

For the quantitative estimation of the undersampling effect, a very recent approach developed by Carr's research group was employed<sup>[9]</sup>, which also accounts for the effective retention time window and the second dimension gradient time. By applying such a calculation, the peak capacity calculated for the 2D-LC system was further halved, yielding a value of 1802.

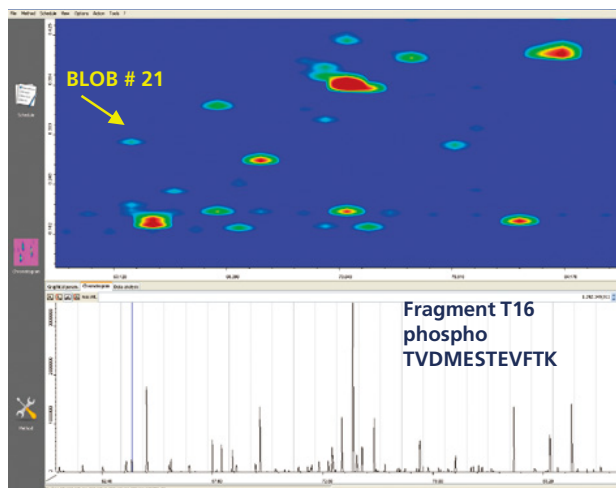

Fig. 5 ChromSquare software window showing an expansion of the  $\alpha$ -casein 2D plot and the MS (ESI pos) spectrum of a phosphorylated peptide

In Fig. 5 is depicted the ChromSquare software window for qualitative/quantitative data analysis, showing an enlargement from the contour plot of Fig. 2. The lower window allows visualization of the whole modulation, while integration of some peaks in the selected region of interest further allows calculation of retention times in the two dimensions, as well as peak area calculation for distinctive fragments.

Fig. 6 shows a five-minute enlargement of the raw RP-LC×RP-LC-PDA-IT-TOF chromatogram corresponding to the plot in Fig. 2, and the average mass spectrum obtained for three consecutive peaks (1 min interval, corresponding to the modulation time set) are depicted in the inset. This demonstrates that at least three fractions of the peptide with  $m/z$  747.3650 have been transferred from the first to the second dimension of the comprehensive system.

The acquired mass spectrometry data were manually processed, by averaging the number of scans within each chromatographic peak, and deconvolution of charge envelope was afterwards performed for  $[M+H]^+$  and  $[M+nH]^{n+}$  ions. The corresponding window of the LCMsolution software is shown in Fig. 7.

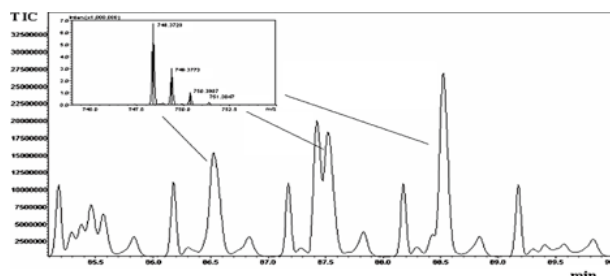

Fig. 6 Five-minute TIC from the RP-LC×RP-LC-PDA-IT-TOF separation of  $\alpha$ -casein tryptic digest

The experimental deconvoluted molecular masses of the peptides were then compared to the theoretical values obtained by *in-silico* digestion of the proteins, to obtain the relative sequence coverage.

*In-silico* digestion of  $\alpha$ -casein and dephosphorylated  $\alpha$ -casein was performed by using PeptideMass software available at ExPASy site ([www.expasy.ch/tools/peptide-mass.html](http://www.expasy.ch/tools/peptide-mass.html)), selecting up to three missed cleavages (MC) for the generation of peptides.

For each identified peptide, monoisotopic molecular masses of the phosphorylated and the corresponding dephosphorylated forms are reported, together with the position of the modified aminoacidic residues (phosph. site). Many of the differences in the plots in Fig. 2 are obviously related to the presence or absence of phosphorylated peptides.

Since phosphorylation occurs on the serine residue, and a difference of (roughly) 80 Da was observed for removal of each phosphate group, it must be conclusive that only  $HPO_3^-$  is removed by dephosphorylation, leaving the serine residue intact.

By combining the results obtained from the two RP-LC dimensions, sequence coverage of 90.3% and 76.3% for  $\alpha$ -casein and dephosphorylated  $\alpha$ -casein, respectively, were obtained. Comparison with the corresponding values of 68.2% and 56.4% obtained for the monodimensional system (D1, four coupled columns) clearly demonstrates the usefulness of the 2D-LC system.

Identified peptides in  $\alpha$ -casein tryptic digest are shown in the plot in Fig. 8.

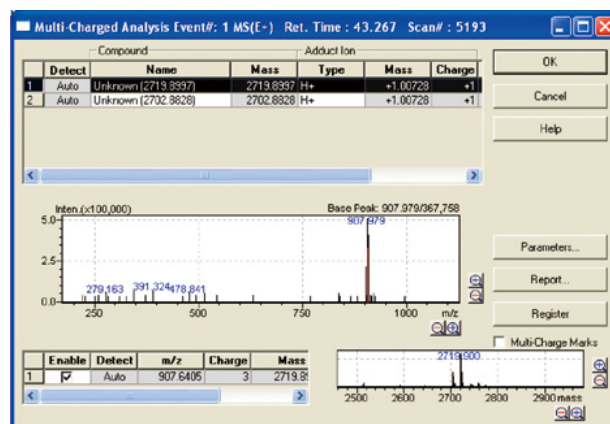

Fig. 7 LCMsolution software window for peak deconvolution

## 4. Conclusions

A fully automated 2D RP-LC×RP-LC system, coupled to PDA and LCMS-IT-TOF detection was successfully employed for the analysis of  $\alpha$ -casein and dephosphorylated  $\alpha$ -casein tryptic digests.

Due to the ionic nature of peptides, the use of different pH values ensured enough separation selectivity between the two dimensions, consisting of the same stationary phase. Furthermore, such a combination addresses compatibility issues, thus allowing straightforward interfacing in on-line 2D LC configuration, as well as direct linkage to a mass spectrometer.

The results achieved so far hold promise for further optimization of the technique, as a valuable tool to investigate the nature of native and recombinant proteins of clinical relevance.

## References

- [1] Gorg, A., Weiss, W., Dunn, M. J., *Proteomics* 2004, 4, 3665–3685.
- [2] Rabilloud, T., *Proteomics* 2002, 2, 3–10.
- [3] Beranova-Giorgianni, S., *Trends Anal. Chem.* 2003, 22, 273–281.
- [4] Reinders, J., Zahedi, R. P., Pfanner, N., Meisinger, C., Sickmann, A., *J. Proteome Res.* 2006, 5, 1543–1554.
- [5] Gilar, M., Olivova, P., Daly, A. E., Gebler, J. C., *J. Sep. Sci.* 2005, 28, 1694–1703.
- [6] Schley, C., Altmeyer, M., Mller, R., Swart, R., Huber, C. G., *J. Proteome Res.* 2006, 5, 2760–2768.
- [7] Bushey, M. M., Jorgenson, J. W., *Anal. Chem.* 1990, 62, 978–984.
- [8] Liu, Z., Patterson, D. G., Lee, M. L., *Anal. Chem.* 1995, 67, 3840–3845.
- [9] Gu, H., Huang, Y., Carr, P. W., *J. Chromatogr. A* 2011, 1218, 64–73.

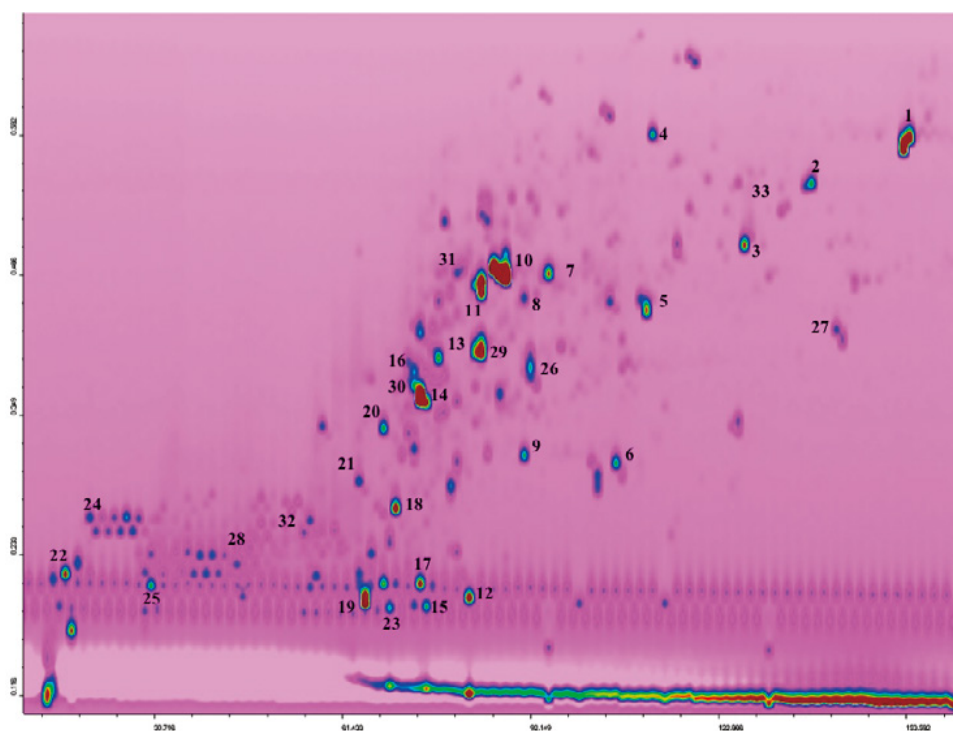

Fig. 8 Identified peptides in the 2D RP-LC×RP-LC plot of  $\alpha$ -casein tryptic digest

# Technical Report

## Stop-flow Comprehensive Two-dimensional Liquid Chromatography Combined with Mass Spectrometric Detection for Phospholipid Analysis LCxLC for phospholipids in milk and plasma samples

Paola Dugo<sup>1,2</sup>, Nermeen Fawzy<sup>1</sup>, Francesco Cacciola<sup>1</sup>, Paola Donato<sup>1</sup>, Filomena Cichello<sup>1</sup>, Luigi Mondello<sup>1,2</sup>

### Abstract:

A novel comprehensive two-dimensional liquid chromatographic (LCxLC) system for characterization of phospholipid (PL) molecular species belonging to six phospholipid classes was developed. To tackle such a task, a silica hydrophilic interaction liquid chromatography (HILIC) column was used as the first dimension (D1), and reversed-phase liquid chromatography (RP-LC) with a C18 column was used as the second dimension (D2) in combination with mass spectrometric detection. Fraction transfer from the D1 to the D2 was performed by means of a two-position ten-port switching valve, operated under stop-flow conditions. The capability of the investigated LCxLC approach was demonstrated in the separation of phospholipid molecular species contained in two Folch-extracted cow's milk and plasma samples.

**Keywords:** comprehensive LC, phospholipids, mass spectrometry, stop-flow

## 1. Introduction

Phospholipids (PLs) are an important class of biomolecules playing an important functional, structural and metabolic role in the human body as witnessed by recent studies which have given considerable evidence on the health-promoting effects such as antiinflammatory activity and risk reduction of cardiovascular diseases.

Several analytical methods have been developed for characterization of molecular species within different PL classes. From a chromatographic stand-point, it must be noted that the employment of a single technique can only provide useful information on either the different phospholipid classes or the molecular species within a particular PL class.

In this technical report, in order to simultaneously separate and identify the different PL classes together with the separation and identification of the different molecular species within each class, a fully comprehensive LC (LCxLC) method was developed for the first time. Such a system comprised of a silica hydrophilic interaction liquid chromatography (HILIC) column in the first dimension (D1) and an octadecylsilica column in the second dimension (D2) and was run under stop-flow conditions. The capability of such a system (Fig. 1) was evaluated for analysis of PLs contained in two Folch-extracted cow's milk and plasma samples (Fig. 2).



Fig. 1 LCxLC/MS instrumentation

## 2. Experimental

### 2-1. Samples and sample preparation

A crude cow's milk sample was provided by a Calabrian producer whereas the plasma sample was kindly donated by a sane volunteer.

Extraction of the lipid fraction was carried out from 10 mL and 1.5 mL, respectively, of the cow's milk and plasma sample, according to the Folch method in order to attain an exhaustive extraction of the whole lipid content. The total extract was evaporated under vacuum, and the final dry residue (400 and 150 mg for cow's and donkey's milk, respectively) was re-dissolved in chloroform/methanol 2:1 (v/v) and stored at  $-18^{\circ}\text{C}$  until use.

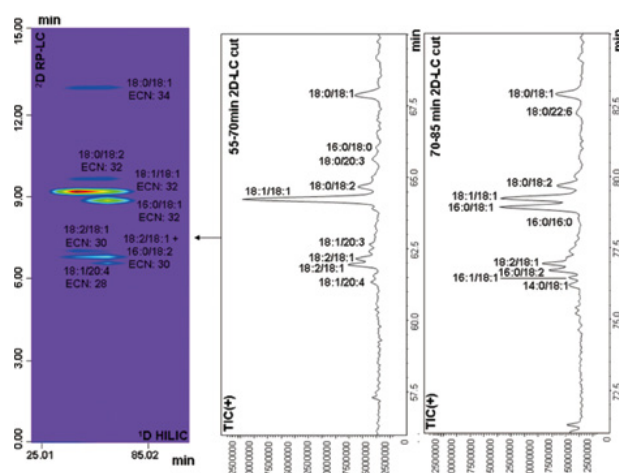

Fig. 2 Enlargement of the HILICxRP-LC-ESI-MS contour plot for separation of the phosphatidylethanolamine (PE), along with the corresponding 2D raw data

<sup>1</sup> University of Messina, Italy  
<sup>2</sup> Chromaleont S.r.l.



## 2-2. Reagents and Materials

For the extraction procedure, chloroform and methanol were obtained from VWR (Milan, Italy).

For LC×LC–MS analyses, water, acetonitrile, methanol, tetrahydrofuran, isopropanol, all LC–MS grade, and formic acid were purchased from Riedel-de Haën (Seelze, Germany). Ammonium formate was obtained from Alfa Aesar GmbH & Co., KG (Karlsruhe, Germany). The pH of buffered mobile phases was adjusted to 5.5 by adding a few drops of formic acid. The standards of phosphatidylinositol (PI), phosphatidylserine (PS), phosphatidylethanolamine (PE), phosphatidylcholine (PC), sphingomyelin (SM) and lysophosphatidylcholine (LPC) were purchased from Sigma–Aldrich/Supelco (Bellefonte, PA, USA).

Chromatographic separations were carried out using different columns provided by Supelco (Bellefonte, PA, USA): Ascentis Express HILIC (150 mL × 2.1 mm i.d., 2.7 μm d.p.), and Ascentis Express C18 (150 mL × 4.6 mm i.d., 2.7 μm d.p.).

## 2-3. LC×LC instrumentation and software

- Shimadzu CBM-20A controller
- two Shimadzu LC-20AD dual-plunger parallel-flow pumps
- Shimadzu LC-20AB dual-plunger parallel-flow pumps
- Shimadzu DGU-20As degassing unit
- Shimadzu CTO-20A column oven
- Shimadzu SIL-20AC autosampler
- Shimadzu SPD-M20A photo diode array detector (2.5 μL detector flow cell)
- Shimadzu LCMS-2020 mass spectrometer

For connecting the two dimensions: 2-position 10-port switching valve (Supelco, Bellefonte, PA, USA) placed inside the column oven and equipped with two identical 20 μL sample loops.

## 2-4. Software

- Shimadzu LabSolutions (Version 5.41 SP1)

## 2-5. 2D Software

- ChromSquare (Version 2.0) from Chromaleont, Messina, Italy

## 2-6. LC×LC-MS conditions

### D1 separations: Ascentis Express HILIC

Flow rate	: 0.1 mL·min <sup>-1</sup>
Mobile phases	: (A) acetonitrile/ammonium formate (10 mM) buffer pH 5.5 (90:10) and (B) acetonitrile/methanol/ammonium formate (10 mM) buffer pH 5.5 (55:35:10)
Gradient elution	: 0 min, 0% B; 20 min, 0% B; 25 min, 100% B; 210 min, 100% B; 211 min, 0% B
Injection volume	: 10 μL.

### D2 separations: Ascentis Express C18

Mobile phase	: (A) ammonium formate buffer (10 mM; pH 5.5)/isopropanol/tetrahydrofuran (30:55:15) and (B) acetonitrile. Isocratic elution (40% B)
Flow rate	: 3.0 mL·min <sup>-1</sup> . Prior to MS detection, the mobile phase flow rate was reduced to 0.3 mL·min <sup>-1</sup> through a T-piece union.
Modulation time of the switching valve	: 15 min

## MS conditions

MS acquisition performed using the ESI interface operating in both positive and negative ionization modes:

mass spectral range: 200–1100 *m/z*; event time: 1 sec; scan speed: 938 amu/s; nebulizing gas (N<sub>2</sub>) flow: 1.5 L·min<sup>-1</sup>; drying gas (N<sub>2</sub>) flow: 15 L·min<sup>-1</sup>; interface temperature: 350°C; heat block temperature: 200°C; desolvation line (DL) temperature: 250°C; DL voltage: –34 V; probe voltage: +4.5 kV; Qarray DC voltage: 1 V; Qarray RF voltage: 100 V; detection gain: 0.8 kV.

## 3. Results and discussion

The objective of this work was to develop an HILIC×RP-LC system in combination with mass spectrometric detection for analysis of PL molecular species contained in Folch-extracted cow's milk and plasma samples. Prior to HILIC×RP-LC separations the two dimensions were optimized independently.

## 4. Optimization of D1 and D2 separation systems

HILIC separation can be described either as liquid–liquid partition chromatography, or a version of NP-LC, run with partially aqueous mobile phases. Compounds are separated by passing normally an organic mobile phase across a neutral hydrophilic stationary phase, thus solutes are eluted in order of increasing hydrophilicity; the separation selectivity is, therefore, complementary to that in reversed phase mode. The use of higher-organic content mobile phases is advantageous in providing larger diffusion constants of analytes during their migration through the column, allowing a partial separation of molecular species and also better ionization efficiency in electrospray ionization.

Fig. 3 shows the total ion current (TIC) chromatogram of a HILIC-ESI-MS analysis of three different samples, namely, PL standard mixture (A), Folch-extracted cow's milk (B), Folch-extracted plasma sample (C). Baseline separation of the six PL classes was achieved, under gradient conditions, within a run time of 30 min, according to decreasing polarity viz. PI eluted first followed by PE and PS; the PL classes, containing the phosphocholine head group (PC, SM and LPC), were the most retained and thus the latest to elute. Identification was carried out by the inspection of both [M+H]<sup>+</sup> and [M–H]<sup>–</sup> ions, the latter employed for better ionization of PI.

For the 2D separations, a C18 column packed with 2.7 μm particles was employed. RP-LC separation is mainly achieved on the basis of the difference in chain length and the number of fatty acid double bonds (i.e. essentially on the lipophilicity), viz. increasing equivalent carbon number (ECN), defined as the total carbon number (CN) of fatty acids minus two times the double bond (DB) number (ECN = CN – 2DB).

Fig. 4 shows the TIC chromatogram from the positive-ion LC–ESI-MS analysis of a PC standard. Baseline separation of six of them was achieved, at a flow rate of 0.9 mL/min, under isocratic conditions, within a run time of 15 min. The retention of molecular species increased proportionally to the ECN, from 24 to 34).

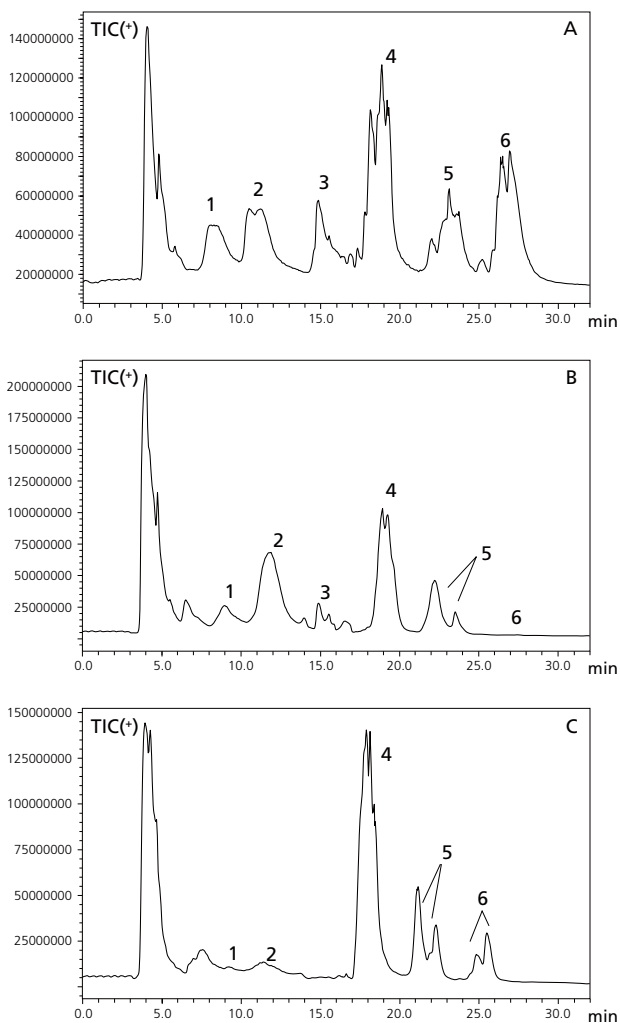

**Fig. 3** Positive-ion HILIC-ESI-MS TIC (total ion current) chromatogram of a phospholipid standard mixture (A), Folch-extracted cow's milk (B), Folch-extracted plasma sample (C) (1) Phosphatidylinositol (PI); (2) Phosphatidylethanolamine (PE); (3) Phosphatidylserine (PS); (4) Phosphatidylcholine (PC); (5) Sphingomyelin (SM); (6) Lysophosphatidylcholine (PLC).

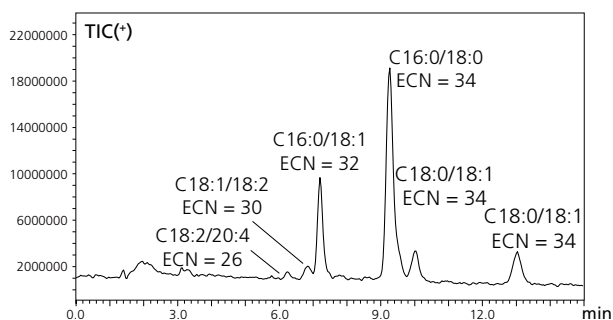
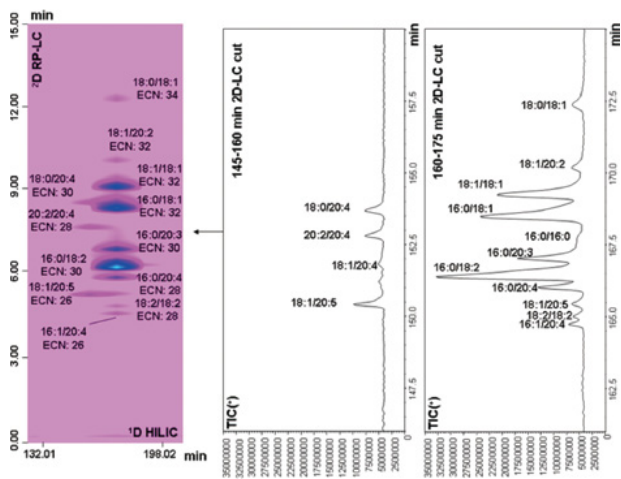

**Fig. 4** Positive-ion RP-LC-ESI-MS TIC chromatogram of the different molecular species identified in a PC standard

## 5. HILIC×RP-LC for phospholipid (PL) separation

After a proper optimization of the two different separation systems, an HILIC×RP-LC system was tuned.

For both samples, the PC turned out the richest in terms of molecular species. As an example, an enlargement of the HILIC×RP-LC-ESI-MS contour plot, with the corresponding 2D raw data for the plasma sample, is reported in Fig. 5. Up to sixteen and fourteen molecular species, belonging to PC classes, over two 15 min modulation cycles were positively identified in cow's milk and plasma samples, respectively. The observed chromatographic pattern fits to the expected PL separation based on increasing hydrophobicity, viz. increasing ECN values, ranging from 26 to 34. It is worth mentioning that the employed 2D mobile phase allowed to successfully separate also isobaric species. A list of the major species contained in a phospholipid standard mixture, cow's milk sample and a plasma sample is reported in Table 1.



**Fig. 5** Enlargement of the HILIC×RP-LC-ESI-MS contour plot along with the corresponding 2D raw for separation of the PC molecular species contained in the plasma sample

## 6. Conclusions

The aim of the present research was to separate simultaneously the PL fraction belonging to different classes along with the molecular species corresponding to those classes, by using a comprehensive HILIC × RP-LC-ESI-MS system in stop-flow mode.

The combination of HILIC and RP-LC techniques with ESI-MS as detection system, allowed to achieve separation of individual molecular species contained in two Folch-extracted cow's milk and plasma samples. In particular, PC turned out to be the most complex one, and up to 16 and 14 different species were identified, respectively.

The only drawback was the long analysis time due to the stop-flow mode employed even though this is well compensated by the enhanced resolving power and the greater amount of analyte information obtained.

Since each second-dimension peak corresponds to a single PL species, which is eluted according to increasing hydrophobicity, the developed 2D-LC system can be used also in absence of tandem mass spectrometry detection in favour of less expensive techniques such as single quadrupole MS or ELS, for analysis of other lipid classes of different origin.

Table 1 List of the major species contained in a phospholipid standard mixture, cow's milk sample and a plasma sample

PL class	Standard mixture		Cow's milk sample		Plasma sample	
	m/z	FAs	m/z	FAs	m/z	FAs
Phosphatidylinositol (PI)	[M-H] <sup>-</sup> 831.5 833.5 835.5 857.6 859.5 861.5	16:1/18:2 16:0/18:2 16:0/18:1 16:0/20:4, 18:2/18:2 18:2/18:1 18:0/18:2, 18:1/18:1	[M-H] <sup>-</sup> 835.5 859.5 861.5 863.5 887.5	16:0/18:1 18:3/18:0 18:0/18:2, 18:1/18:1 18:0/18:1 20:3/18:0	[M-H] <sup>-</sup> 885.5	18:0/20:4, 18:1/20:3
Phosphatidylethanolamine (PE)	[M+H] <sup>+</sup> 744.5	18:0/18:2	[M+H] <sup>+</sup> 690.6 692.5 716.6 718.6 742.6 744.6 746.6 766.7 768.5 770.6 792.5	14:0/18:1 16:0/16:0 16:0/18:2, 16:1/18:1 16:0/18:1 18:2/18:1 18:1/18:1, 18:0/18:2 18:0/18:1 18:1/20:4 18:1/20:3 18:0/20:3 18:0/22:6	[M+H] <sup>+</sup> 744.5 764.6 768.5 792.5	18:1/18:1, 18:0/18:2 16:0/22:6 18:0/20:4 18:0/22:6
Phosphatidylserine (PS)	[M+H] <sup>+</sup> 788.6 790.6 836.6 838.6 840.5	18:0/18:2 18:0/18:1 16:0/20:3 16:0/20:2 16:1/20:0	[M+H] <sup>+</sup> 786.5 788.5 790.6	18:2/18:1 18:0/18:2 18:0/18:1	n.d.	n.d.
Phosphatidylcholine (PC)	[M+H] <sup>+</sup> 732.5 758.6 760.5 782.5 784.5 786.5 788.5 790.5 792.6 806.5 810.5 818.6 834.6 836.6	16:0/16:1 16:0/18:1 16:0/20:4 18:2/18:2 18:1/18:2 18:1/18:1 18:0/18:1 18:1/22:6 18:0/22:6 18:2/20:4 18:2/20:2 20:1/22:6 18:0/20:4 18:0/22:5	[M+H] <sup>+</sup> 706.6 720.5 732.5 734.5 746.5 748.6 756.5 758.6 760.5 762.5 774.5 782.5 784.6 786.6 788.6	16:0/14:0 15:0/16:0 16:0/16:1 16:0/16:0 15:0/18:1 15:0/18:0 16:0/18:3 16:0/18:2 16:0/18:1 16:0/18:0 17:0/18:1 18:2/18:2 18:1/18:2 18:0/18:2, 18:1/18:1 18:0/18:1	[M+H] <sup>+</sup> 885.5	18:0/20:4, 18:1/20:3
Sphingomyelin (SM)	[M+H] <sup>+</sup> 703.6 705.6 731.5	16:0 18:0 18:0	[M+H] <sup>+</sup> 675.6 689.5 703.6 705.6 759.5 773.5 785.6 787.6 799.6 801.5 813.5 815.5	14:0 15:0 16:0 16:0 20:0 21:0 22:1 22:0 23:1 23:0 24:1 24:0	[M+H] <sup>+</sup> 675.5 701.5 703.5 729.5 731.5 759.6 785.6 787.5 811.5 813.5 815.5	14:0 18:1 16:0 18:1 18:0 20:0 22:1 22:0 24:2 24:1 24:0

First Edition: December, 2015



Shimadzu Corporation  
www.shimadzu.com/an/

For Research Use Only. Not for use in diagnostic procedures.  
The content of this publication shall not be reproduced, altered or sold for any commercial purpose without the written approval of Shimadzu.  
The information contained herein is provided to you "as is" without warranty of any kind including without limitation warranties as to its accuracy or completeness. Shimadzu does not assume any responsibility or liability for any damage, whether direct or indirect, relating to the use of this publication. This publication is based upon the information available to Shimadzu on or before the date of publication, and subject to change without notice.

© Shimadzu Corporation, 2015

# Application News

## No. L462

### High Performance Liquid Chromatography

## Glycerophospholipids Analysis by Comprehensive HPLC Coupled with a Triple Quadrupole Mass Spectrometer

Glycerophospholipids (GPLs) are the major component of biological membranes. They can not only act as a barrier from the external environment, but can also play a key role in a variety of biological processes including membrane trafficking and signal transduction. Thus, analysis of GPLs is one of the most important studies in the metabolomics field. Although reversed phase (RP) HPLC coupled with electrospray ionization (ESI) MS/MS is an effective strategy for lipidomics, there is still room for further improvement of the analytical methods. One drawback to performing determination of GPLs is ion suppression caused by co-eluting compounds. To obtain reliable results, complete separation of target GPLs by comprehensive HPLC with ESI-MS/MS is an effective strategy.

### Flow Diagram of Comprehensive HPLC

Fig. 1 shows the flow diagram of the comprehensive HPLC-ESI-MS/MS system. The system comprises 2 flow lines: one for the first dimension separation with a normal phase column and the second dimension separation with a reversed phase column. A mixture of GPLs was roughly classified by normal phase chromatography in the first dimension. All the eluents are trapped into two loops alternatively. Then the entire eluents are introduced into second dimensional reversed phase UHPLC without any risk of sample-loss. The GPLs of interest are separated according to the orthogonal retention selectivity and detected with ESI-MS/MS quantitatively.

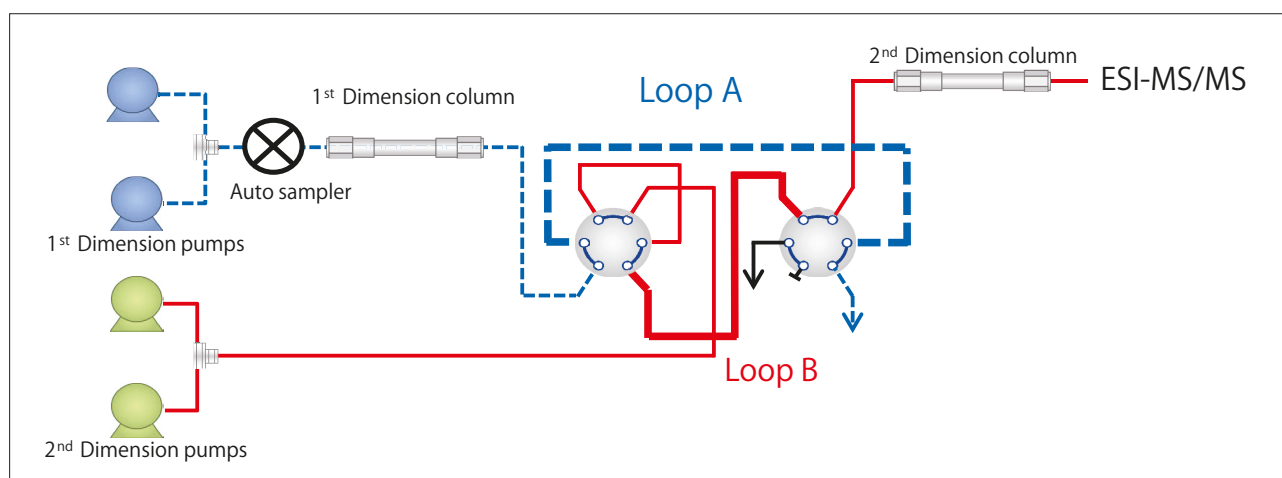

Fig. 1 Flow Diagram of the Comprehensive HPLC-ESI-MS/MS System

Table 1 Analytical Conditions

1D Column	: Nucleosil SIL (150 mm L. × 1.0 mm I.D., 3 μm)
Mobile Phase	: A: Isooctane / Acetone / Ethyl Acetate / Acetic acid = 40/20/20/0.03 (v/v/v/v) B: Isooctane / 2-propanol / Water / Acetic acid / 28 % Ammonia aq.sol. = 40/51/9/0.03/0.03 (v/v/v/v/v)
Flowrate	: 0.02 mL/min
Time Program	: B Conc. 30 % (0 min) → 40 % (25 min) → 100 % (40 min) → 100 % (55 min) → 30 % (55.1 min) → STOP (70 min)
Column Temp.	: 40 °C
Injection Vol.	: 5 μL
Loop Vol.	: 20 μL
2D Column	: Phenomenex Kinetex C18 (50 mm L. × 4.6 mm I.D., 2.6 μm)
Mobile Phase	: A: Methanol / Water / Acetic acid / 28 % Ammonia aq.sol. = 90/10/0.05/0.05 (v/v/v/v) B: 2-propanol / Acetic acid / 28 % Ammonium hydroxide = 100/0.05/0.05 (V/V/V)
Flowrate	: 3.5 mL/min (50 % split to MS)
Time Program	: B Conc. 10 % (0 min) → 50 % (0.75 min) → 10 % (0.76 min) → STOP (1 min) The initial B Conc. has been changed by a stepwise method
Detector	: Shimadzu LCMS-8050 (ESI positive, MRM mode)

■ Comprehensive Separation of Glycerophospholipids

Comprehensive Separation of GPLs in ESI-positive MRM mode are shown in Fig. 2.

The GPLs mixture was comprised of 500 ppb each of Phosphatidylglycerol (PG), Phosphatidylethanolamine (PE), Phosphatidylinositol (PI), Phosphatidylserine (PS) and Phosphatidylcholine (PC). The 2D plot of ESI-positive MRM shows the separation of PG, PE, PI, PS and PC. The repeatability (n=5) of retention times and blob areas, which correspond to peak areas in ordinary quantitation and linearity for 50-5000 µg/L of each 3 PC compounds are shown in Table 2.

Necessary information for compound-identification is shown in Fig. 2.

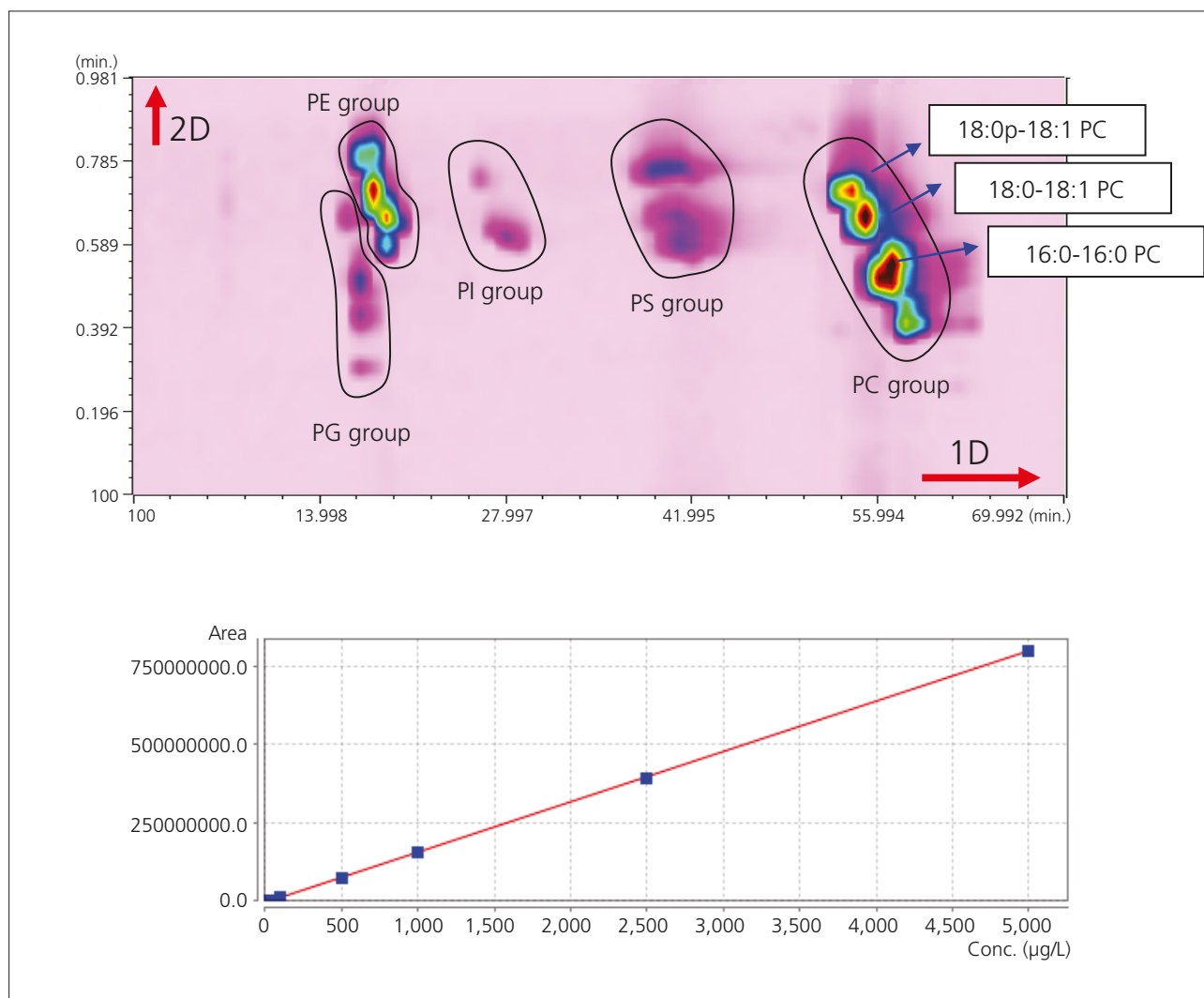

Fig. 2 Comprehensive Separation and Calibration Curve of GPLs

Table 2 Repeatability of 5 Analyses in %RSD and Linearity of 50-5000 µg/L for 3 PC Compounds

Compound	MRM transition	Total retention time	Retention time (2D)	Blob Area	Correlation coefficient (R)
16:0-16:0 PC	<i>m/z</i> 734.6 > 184.1	0.0072	0.9	6.8	0.999799
18:0-18:1 PC	<i>m/z</i> 788.6 > 184.1	0.013	1.1	8.9	0.999947
18:0p-18:1 PC	<i>m/z</i> 772.6 > 184.1	0.013	1.2	6.4	0.999656



# Application News

## No. L488

### High Performance Liquid Chromatography

## Peptide Mapping of Antibody Drugs by Nexera-i

Peptide mapping by HPLC is one of the important quality assurance tests used for verifying the primary structure of antibody drugs. Typically, following enzymatic digestion of the antibodies, separation is conducted using a traditional reversed phase column. Due to the large number of peaks that require separation, the use of small-particle columns and core shell columns for peptide analysis has spread in recent years.

In order to compare elution profiles for identity and mutation confirmation, a highly repeatable system is required. The Nexera-i integrated UHPLC is the ideal system for such an analysis. Here, the Nexera-i is used in the analysis of IgG (human immunoglobulin G) tryptic digest.

### ■ Analysis of IgG Tryptic Digest

For this investigation, after reduction and alkylation of IgG, tryptic enzyme digestion was used as shown in Fig. 1 for sample preparation.

Table 1 shows the analytical conditions. Here, the Aeris 1.7  $\mu\text{m}$  PEPTIDE XB-C18 100  $\text{\AA}$  small-particle core-shell column and the Nexera-i integrated UHPLC system was used. Mobile phase A was 0.1 % trifluoroacetic acid (TFA) in water and mobile phase B was 0.08 % TFA in acetonitrile. To ensure proper gradient performance with TFA, an optional 300  $\mu\text{L}$  mixer was used.

Fig. 2 shows the chromatogram of IgG tryptic digest, in which an extremely large number of peaks are clearly separated.

**Table 1 Analytical Conditions**

Column	: Aeris 1.7 $\mu\text{m}$ PEPTIDE XB-C18 100 $\text{\AA}$ (150 mm L. $\times$ 2.0 mm I.D., 1.7 $\mu\text{m}$ )
Mobile Phase	: A: 0.1 % trifluoroacetic acid in water B: 0.08 % trifluoroacetic acid in acetonitrile
Time Program	: B.Conc. 0 % (0 min) $\rightarrow$ 45 % (90 min) $\rightarrow$ 100 % (90.01 - 95 min) $\rightarrow$ 0 % (95.01 - 110 min)
Flowrate	: 0.2 mL/min
Column Temp.	: 60 $^{\circ}\text{C}$
Injection Vol.	: 10 $\mu\text{L}$
Detection	: LC-2040C 3D at 215 nm
Flow Cell	: High-speed high-sensitivity cell

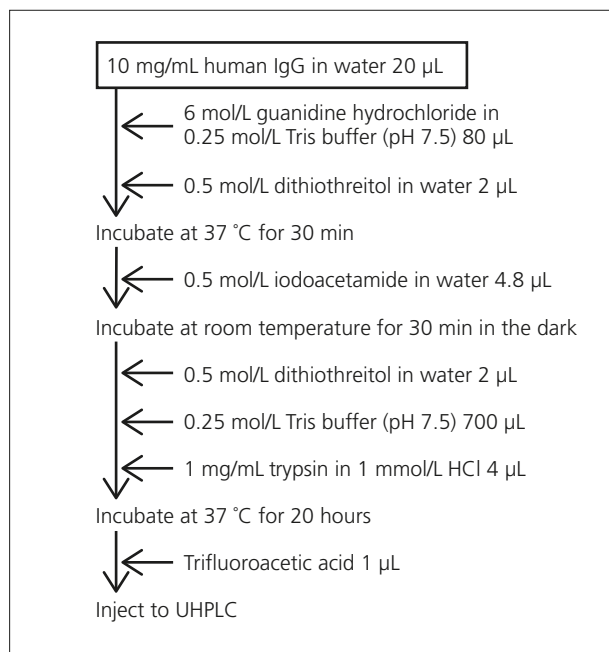

**Fig. 1 Sample Preparation**

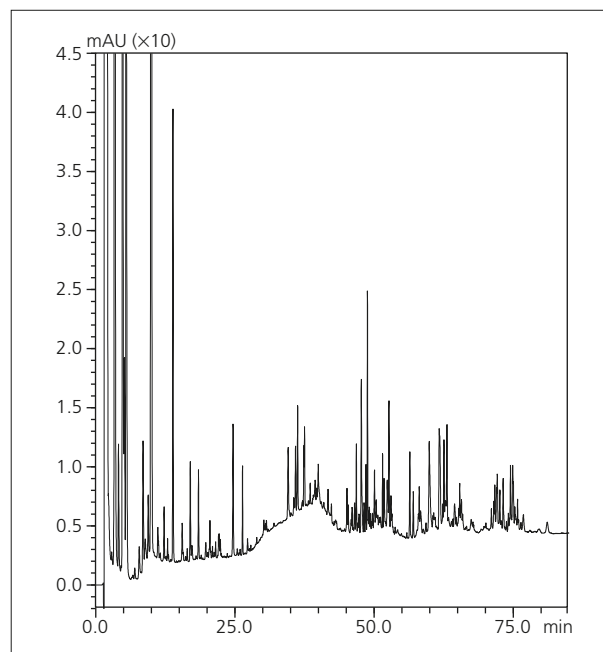

**Fig. 2 Chromatogram of IgG Tryptic Digest**

■ Repeatability

Due to the large number of peaks that must be separated when conducting peptide mapping, a gradient with a long shallow slope is required. In this analysis, the mobile phase B percentage changes from 0 % to 45 % over 90 minutes, resulting in a slope of 0.5 %/min. The optimized low-pressure gradient valve of the Nexera-i and mixer selection for use with TFA will provide repeatable delivery even with a shallow gradient.

Tables 2 and 3 show the intra-day and inter-day repeatability of retention time, respectively. Fig. 3 shows the IgG tryptic digest chromatogram intra-day repeatability. Selecting the principal peaks from the chromatogram (peaks labeled a to f), we checked their repeatability. We calculated the intra-day repeatability based on the results of six repeat analyses. The inter-day repeatability was calculated based on average of three analyses per day over a period of six days. In peptide mapping using the Nexera-i, it is clear that good intra-day and inter-day repeatability is obtained.

Table 2 Intra-day Repeatability of Retention Time (n=6)

Peak	Avg. R.T. (min)	Std. Dev. (min)	%RSD (%)
Peak a	9.929	0.027	0.271
Peak b	24.669	0.047	0.192
Peak c	36.299	0.042	0.117
Peak d	48.815	0.033	0.068
Peak e	59.864	0.032	0.054
Peak f	74.535	0.043	0.057

Table 3 Inter-day Repeatability of Retention Time (n=6)

Peak	Avg. R.T. (min)	Std. Dev. (min)	%RSD (%)
Peak a	9.907	0.016	0.159
Peak b	24.708	0.033	0.132
Peak c	36.355	0.034	0.093
Peak d	48.877	0.034	0.069
Peak e	59.901	0.027	0.046
Peak f	74.555	0.036	0.049

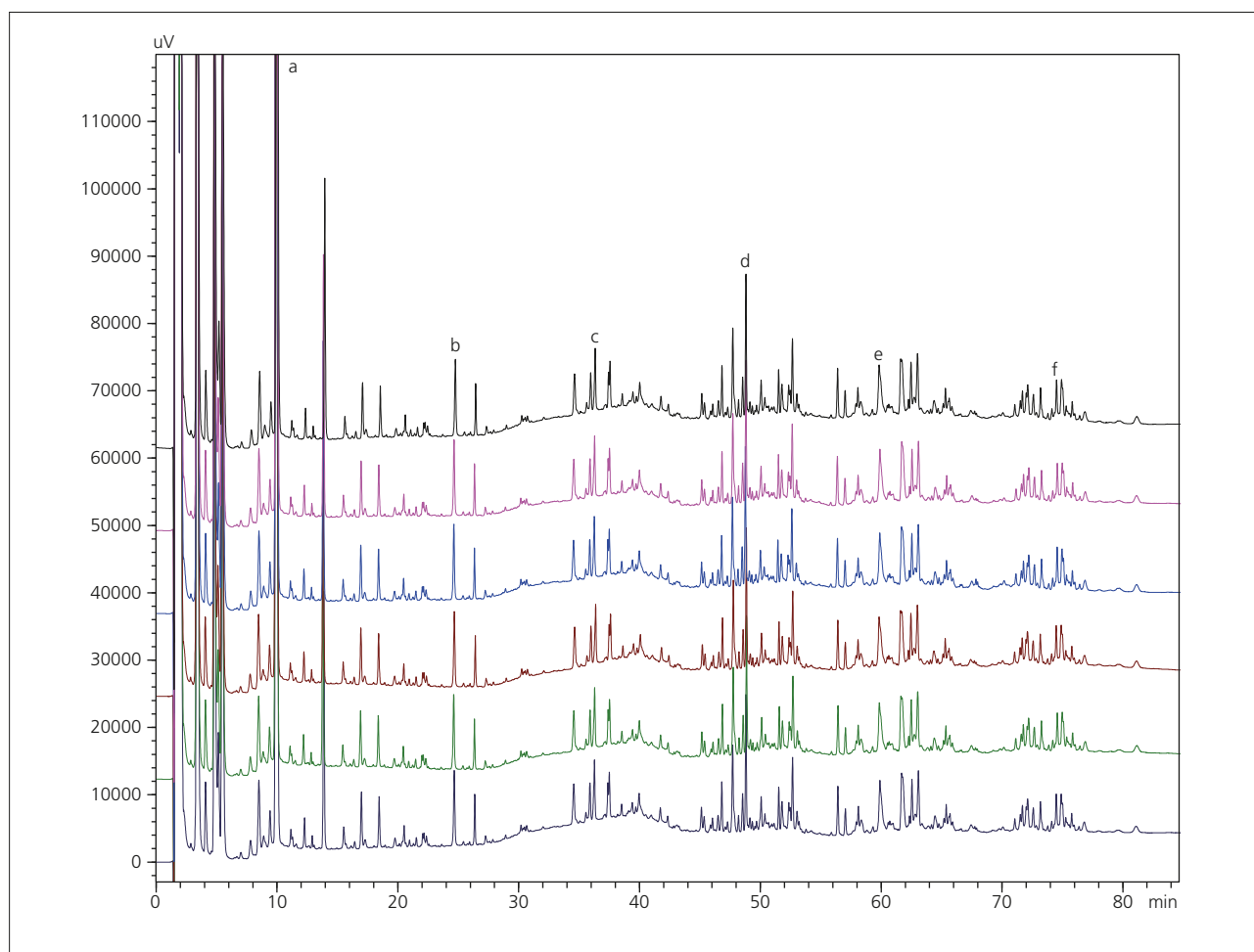

Fig. 3 Intra-day Repeatability of Chromatogram of IgG Tryptic Digest

## 2. Environmental





---

## 2. Environmental

---

A clean environment is the basis for any life on earth. Whether water, soil or air – keeping the environment clean for the protection of all creatures is, and should be, the primary responsibility of any society. Analytical instrumentation is a key technology to measure the status of environmental conditions, this means to diagnose, evaluate and control pollution.

Pure water is the source of life. Its quality can be affected by land contamination when toxic elements find their way into ground- and drinking water. From there, contamination influences crop farming and as a result our food and grocery products. Air and atmosphere suffer from emissions, a product of industrial, private and agricultural activities.

As a company for consumer and product safety, Shimadzu offers the entire bandwidth of technologies to cover environmental application challenges through various analytical instrumentation technologies – chromatography (HPLC, GC, SFC), mass spectrometry (GC-MS, LC-MS, MALDI), sum parameter (TOC), chip electrophoresis and spectroscopy (UV-VIS, FTIR, AAS, ICP-OES). These high-quality products underline Shimadzu's value proposition of Excellence in Science. They combine productivity, accuracy and regulatory requirements. A vast number of solution-oriented application notes provide an indication of where analytical challenges occur and how to solve them.

Find more information on: [www.shimadzu.eu/environment](http://www.shimadzu.eu/environment)





---

## 2. Environmental

---

### **Nexera UC SFE-LCMS/MS**

**L503**            Application of Nexera UC SFE pretreatment system for extracting pesticide residues from soil

### **Prominence-i**

**L476**            Rapid analysis of 2,4-DNPH-derivatized aldehydes and ketones using the Prominence-i system

### **Prominence-i RF**

**L468**            Simultaneous determination of polycyclic aromatic hydrocarbons using the Prominence-i

**L477**            Analysis of anionic surfactants by Prominence-i and RF-20Axs fluorescence detector

### **Prominence-UV**

**32**                Analysis of melamine and related substances in fertilizers

**33**                Analysis of dicyandiamide in fertilizers



# Application News

## No. L503

### Supercritical Fluid Extraction / Chromatography

## Application of Nexera UC SFE Pretreatment System for Extracting Pesticide Residues from Soil

Evaluating the persistence of pesticides in environmental soil is an important criteria for evaluating the safety of pesticides and analyzing pesticides in soil is extremely important for initial evaluations or registration of pesticides. However, in most cases, analyzing pesticides in soil using liquid-liquid extraction to extract the pesticides is very time-consuming, requires special equipment and reagents, and can cause problems, such as metal ions or other introduced ionic substances contaminating analytical instruments or the target substances being decomposed by oxidation, exothermic reactions, or other consequences of the extraction process.

In contrast, supercritical fluid extraction (SFE) provides excellent extraction efficiency using supercritical carbon dioxide as the extraction solvent, which offers the low viscosity and high diffusivity of a gas and the high solubility of a fluid. Consequently, it extracts target substances quickly using smaller quantities of organic solvent than existing solvent extraction methods, making it a more environmentally-friendly method as well.

This article describes an example of using the Nexera UC SFE pretreatment system to extract residual pesticides from soil.

### Off-Line SFE System

The operating principle of the Nexera UC SFE pretreatment system is shown in Fig. 1. An extraction vessel filled with a sample is placed in the SFE unit and heated to 40 °C (Fig. 1 A). The extraction vessel is then filled with supercritical carbon dioxide and the target components are extracted statically without pumping the liquid (Fig. 1 B). After static extraction, the target components are extracted dynamically by pumping supercritical carbon dioxide through the extraction vessel (Fig. 1 C). After trapping the extract material in the trap column, the eluate that contains the target components is then collected in the fraction collector (Fig. 1 D).

### Sample Preparation

Liquid-liquid extraction is typically used to pretreat soil samples for residual pesticide analysis. However, due to the extraction time and equipment required, throughput is low, limiting the number of samples that can be processed in a day. It also requires using organic solvent during extraction. Therefore, an alternative extraction method to liquid-liquid extraction is desirable, in terms of both the environment and cost.

In contrast, the Nexera UC SFE pretreatment system requires only mixing 1 g of soil with 1 g of a dehydrating agent\* and placing the mixture in the extraction vessel,

as shown in Fig. 2. This not only improves productivity and minimizes environmental impact, but also avoids human errors involved in the sample pretreatment process. Furthermore, a specially designed rack changer can be used to perform extraction consecutively for up to 48 samples.

\* "Miyazaki Hydro-Protect" Patent No. 3645552

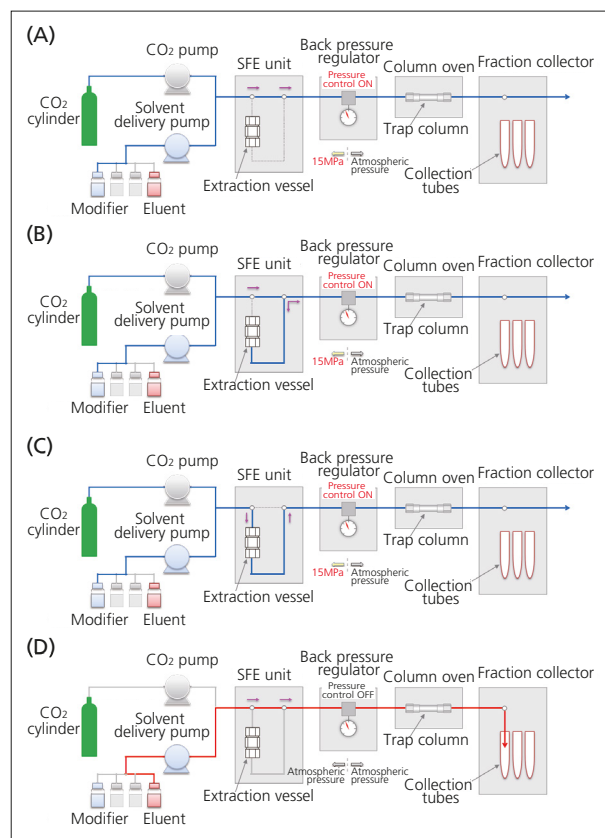

Fig. 1 Process Flow of SFE Extraction

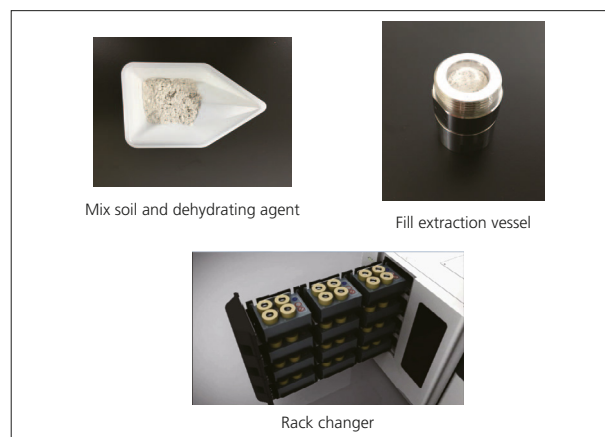

Fig. 2 Sample Preparation

### Extraction and Analysis of Residual Pesticides in Soil

Soil was spiked with 200 ng/g each of eight pesticide components, which were then extracted by SFE using the conditions indicated in Table 1. Eluent was added to the extract obtained to make 2 mL, which was then analyzed by LC-MS/MS using the conditions indicated in Table 1. Repeatability and recovery rate values for the eight pesticide components are shown in Table 2. Recovery rates were determined by comparing the area of pesticide peaks measured from the extract obtained from the soil spiked with pesticide and measured from the extract obtained from unspiked soil to which the pesticides were added after extraction. This system uses a simpler and faster pretreatment process than liquid-liquid extraction, which enables it to finish extraction in about 30 minutes per sample. It also uses less organic solvent, so it is superior in terms of the environment and cost as well.

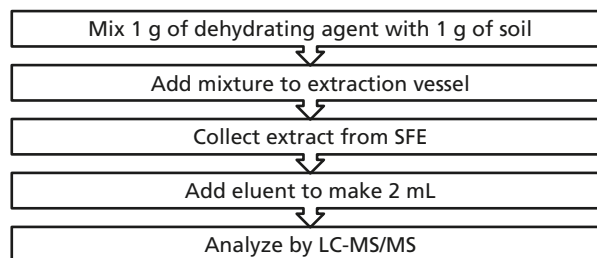

Fig. 3 Process Flow from Pretreatment to Analysis

Table 1 Extraction and Analytical Conditions

[SFE] Nexera UC SFE System	[LC] Nexera X2 System
Solvent : A) Supercritical fluid of CO <sub>2</sub> B) Methanol	Column : Shim-pack UC-RP (150 mm L. × 2.1 mm I.D., 3 μm)
Flowrate : 5 mL/min	Mobile Phase : A) 10 mM Ammonium formate B) 10 mM Ammonium formate in methanol
Extraction : 4 min (Static mode → Dynamic mode)	Time Program : B.Conc. 0 % (0 min) → 100 % (14-17 min) → 0 % (17.1-20 min)
Extraction : 40 °C	Flowrate : 0.4 mL/min
Vessel Temp.	Column Temp. : 40 °C
BPR Pressure : 15 MPa	Injection Volume : 3 μL
Trap Column : Shim-pack VP-ODS (50 mm L. × 4.6 mm I.D., 5 μm)	[MS] LCMS-8060 (MRM mode)
Column : 40 °C	Ionization : ESI (positive or negative)
Oven Temp.	DL Temp. : 200 °C
Elution Solvent : Acetone/Hexane = 50/50 (2 mL/min, 2 min)	Block Heater Temp. : 400 °C
	Interface Temp. : 300 °C
	Nebulizing Gas Flow : 2 L/min
	Drying Gas Flow : 10 L/min
	Heating Gas Flow : 10 L/min

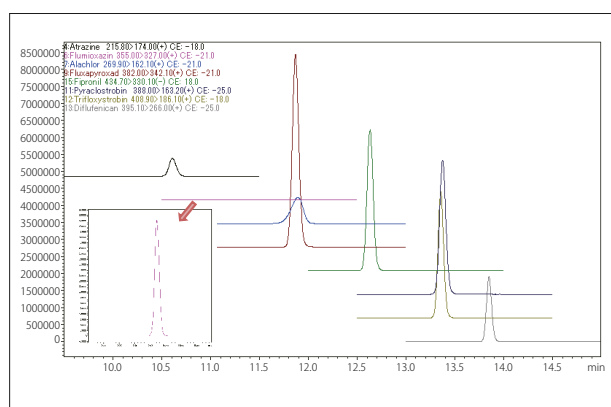

Fig. 4 MRM Chromatogram of Extract from Soil Spiked with Pesticides

Table 2 Repeatability and Recovery

Compounds	Repeatability (%RSD, n=6)	Recovery (%)
Alachlor	1.9	87.0
Atrazine	1.3	75.8
Diflufenican	1.2	86.2
Fipronil	1.5	80.6
Flumioxazin	3.8	70.1
Fluxapyroxad	2.2	72.9
Pyraclostrobin	1.8	73.3
Trifloxystrobin	1.5	87.7

# Application News

## No. L476

### High Performance Liquid Chromatography

## Rapid Analysis of 2,4-DNPH-Derivatized Aldehydes and Ketones Using the Prominence-i with a Shim-pack XR-ODS Column

Application News No. L268 presented a rapid analysis of 2,4-DNPH (2,4-dinitrophenylhydrazine)-derivatized aldehydes and ketones using the LC-2010 integrated high-performance liquid chromatograph with a Shim-pack FC-ODS column. As the goal of this study was to obtain a shorter the analysis time than that using the previous method, we investigated the run conditions for 2,4-DNPH-derivatized aldehydes and ketones using

the new Prominence-i integrated high-performance liquid chromatograph with a 2.2  $\mu\text{m}$  particle size Shim-pack XR-ODS column. Here we present the results of simultaneous analysis of thirteen 2,4-DNPH-derivatized aldehyde and ketone standards run on a conventional 5  $\mu\text{m}$  particle column, and an example of rapid analysis with a 2.2  $\mu\text{m}$  particle column.

### ■ Simultaneous Analysis of 2,4-DNPH-Derivatized Aldehydes and Ketones

Fig. 1 shows the chromatogram obtained from simultaneous analysis of thirteen 2,4-DNPH-derivatized aldehydes and ketones using the analytical conditions shown in Table 1. With the conventional VP-ODS column, separation of the thirteen components is complete within a 30 minute run time. The detection limit and quantitation limit for formaldehyde were determined to be 13 pg and 41 pg, respectively.

**Table 1 Analytical Conditions**

Column	: Shim-pack VP-ODS (150 mm L. $\times$ 4.6 mm I.D., 5 $\mu\text{m}$ )
Mobile Phase	: A: Water/THF = 8/2 B: Acetonitrile
Time Program	: B Conc. 20 % $\rightarrow$ 60 % (30 min) $\rightarrow$ 20 % (30-35 min)
Flowrate	: 1.5 mL/min
Injection Volume	: 10 $\mu\text{L}$
Column Temp.	: 40 $^{\circ}\text{C}$
Detection	: UV 360 nm

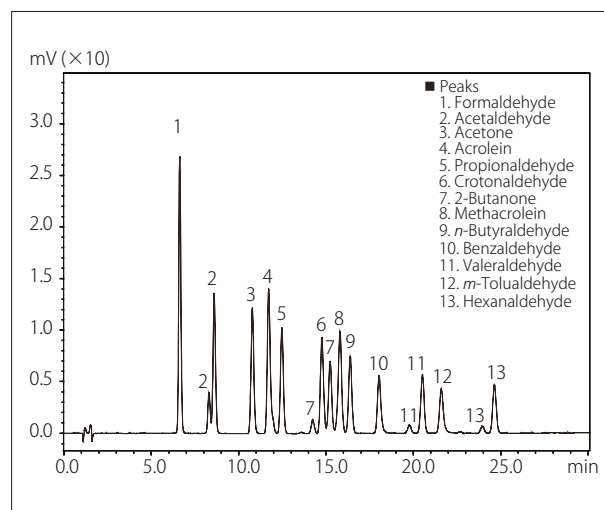

**Fig. 1 Chromatogram of Standard Sample (each at 1.0 mg/L as carbonyl compounds)**

### ■ Linearity

Calibration curves were generated for standard solutions of thirteen 2,4-DNPH-derivatized aldehydes and ketones (each at 0.03 – 3 mg/L, 10  $\mu\text{L}$  injected) using the Shim-pack VP-ODS. Fig. 2 shows the calibration curves for formaldehyde, 2-butanone, and hexanaldehyde. All three compounds produced a linear plot, with an  $R^2$  value of greater than 0.9999 for each. Table 2 shows the area reproducibility values ( $n=3$ ), using a concentration of 1.0 mg/L. The area %RSD values were within 1 % for all components, indicating very good repeatability.

**Table 2 Repeatability of Peak Area (n=3)**

	Area %RSD		Area %RSD
Formaldehyde	0.429	Methacrolein	0.186
Acetaldehyde	0.209	<i>n</i> -Butyraldehyde	0.095
Acetone	0.728	Benzaldehyde	0.979
Acrolein	0.108	Valeraldehyde	0.580
Propionaldehyde	0.222	<i>m</i> -Tolualdehyde	0.355
Crotonaldehyde	0.765	Hexanaldehyde	0.644
2-Butanone	0.969		

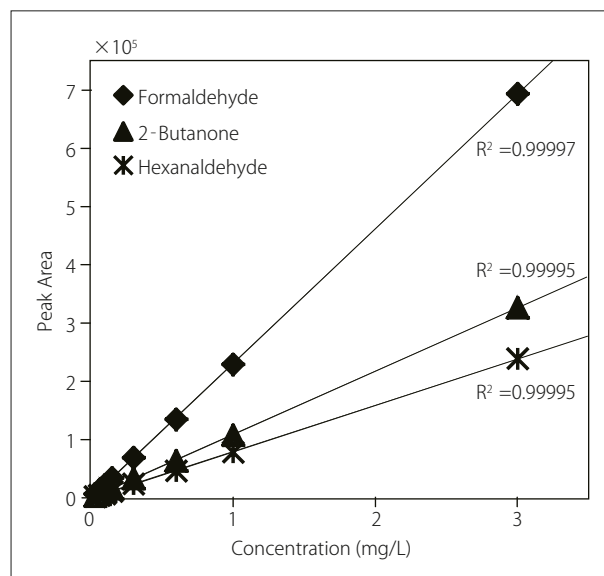

**Fig. 2 Linearity**

### Rapid Analysis of 2,4-DNPH-Derivatized Aldehydes and Ketones

Next, we investigated the use of the Shim-pack XR-ODS (75 mm × 4.6 mm, 2.2 μm) column to shorten the run time. Fig. 3 shows the resulting chromatogram, and Table 3 shows the analytical conditions used. The detection limit of formaldehyde was determined to be 12 pg, and the limit of quantitation, 37 pg. Even with the analysis time shortened by half, from 30 minutes to 15 minutes, the chromatogram showed no adverse effects on resolution or peak shape.

**Table 3 Analytical Conditions**

Column	: Shim-pack XR-ODS (75 mm L. × 4.6 mm I.D., 2.2 μm)
Mobile Phase	: A : Water/THF = 8/2 B : Acetonitrile
Time Program	: B Conc. 20 % → 60 % (15 min) → 20 % (15-17 min)
Flowrate	: 1.5 mL/min
Injection Volume	: 10 μL
Column Temp.	: 40 °C
Detection	: UV 360 nm

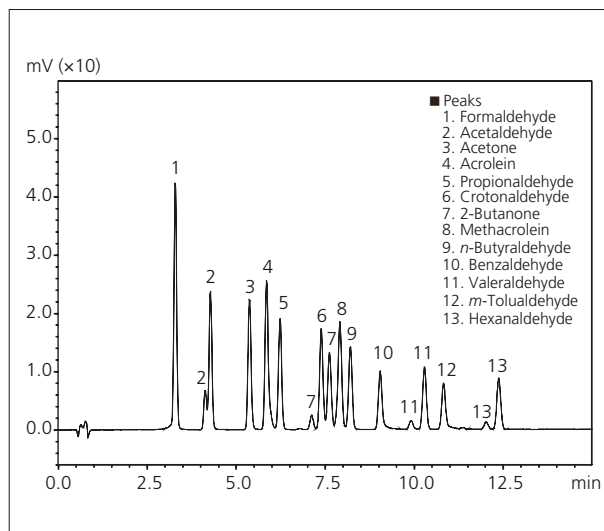

**Fig. 3 Chromatogram of Standard Sample (each at 1.0 mg/L as carbonyl compounds)**

### Linearity in Rapid Analysis

Calibration curves were also generated using the Shim-pack XR-ODS for high-speed analysis of solutions at concentrations ranging from 0.03 to 3 mg/L (10 μL injected) prepared by stepwise dilution of the stock standard solutions of the thirteen 2,4-DNPH-derivatized aldehydes and ketones. Fig. 4 shows the calibration curves for formaldehyde, 2-butanone, and hexanaldehyde. These also showed excellent linearity with R<sup>2</sup> values greater than 0.9999. The area %RSD values at a concentration of 1.0 mg/L for all components were within 1 %, as shown in Table 4.

**Table 4 Repeatability of Peak Area (n=3)**

	Area %RSD		Area %RSD
Formaldehyde	0.255	Methacrolein	0.229
Acetaldehyde	0.139	n-Butyraldehyde	0.333
Acetone	0.139	Benzaldehyde	0.247
Acrolein	0.226	Valeraldehyde	0.101
Propionaldehyde	0.171	m-Tolualdehyde	0.917
Crotonaldehyde	0.423	Hexanaldehyde	0.579
2-Butanone	0.333		

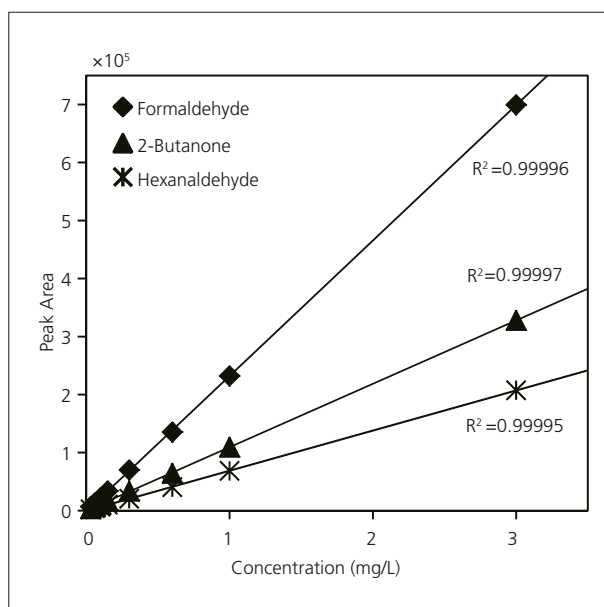

**Fig. 4 Linearity**

# Application News

## No. L468

### High Performance Liquid Chromatography

## Simultaneous Determination of Polycyclic Aromatic Hydrocarbons Using the Prominence-i Integrated High Performance Liquid Chromatograph

Many polycyclic aromatic hydrocarbons exhibit fluorescence, and can therefore be detected with high selectivity and high sensitivity using a fluorescence detector. Previously, in Application News No. 393 and No. 441A, we introduced examples of the simultaneous analysis of polycyclic aromatic hydrocarbons (PAHs) using a fluorescence detector. However, of the sixteen polycyclic aromatic hydrocarbons designated as "priority pollutants" by the U.S. Environmental Protection Agency (EPA), acenaphthylene alone does not exhibit fluorescence. Therefore, a single fluorescence detector cannot be used for simultaneous analysis of all sixteen of these PAHs. However, the Prominence-i, which incorporates a UV detector, can be connected to the RF-20Axs fluorescence detector as an optional detector, permitting simultaneous analysis of all sixteen polycyclic aromatic hydrocarbons. Here, using two analytical methods, one with the wavelength switching mode and the other using simultaneous measurement at multiple wavelengths, we introduce an example of simultaneous analysis of the 16 PAHs.

### ■ Analysis of Polycyclic Aromatic Hydrocarbons Using Wavelength Switching Mode

Fig. 1 (a) shows the chromatogram obtained using a UV detector for analysis (detection wavelength: 254 nm), and Table 1 shows the analytical conditions that were used. Although good separation was obtained using these conditions, the insufficient sensitivity obtained with UV absorption alone is due to the low absorption of ultraviolet light by the PAHs.

Fig. 1 (b) shows chromatograms obtained via simultaneous analysis of sixteen polycyclic aromatic hydrocarbons using the wavelength switching mode according to component group, accomplished by connecting the Prominence-i to an RF-20Axs detector. Table 2 shows the analytical conditions used for conducting analysis via combination of the fluorescence detector and UV detector. The non-fluorescent acenaphthylene is detected by the UV absorption detector at 230 nm, in the vicinity of the wavelength at which it exhibits the maximum absorption. Using these analytical conditions, good sensitivity and separation of the sixteen components is achieved, permitting analysis of each component at the optimum wavelength.

**Table 1 Analytical Conditions**

Column	: RESTEK Pinacle II PAH (250 mm L. × 4.6 mm I.D., 4 μm)
Mobile Phase	: A: Water B: Acetonitrile
Column Temp.	: 40 °C
Time Program	: B Conc. 60 % (0 - 5 min) → 100 % (30 - 35 min) → 60 % (35 - 40 min)
Flowrate	: 1.5 mL/min
Injection	: 5 μL
Detector	: UV at 254 nm

**Table 2 Analytical Conditions**

Detector	: UV at 230 nm RF-20Axs
0.0 - 10.0 min	Ex. at 270 nm, Em. at 330 nm, Gain : X1
10.0 - 12.8 min	Ex. at 250 nm, Em. at 370 nm, Gain : X1
12.8 - 16.0 min	Ex. at 330 nm, Em. at 430 nm, Gain : X4
16.0 - 21.0 min	Ex. at 270 nm, Em. at 390 nm, Gain : X1
21.0 - 27.6 min	Ex. at 290 nm, Em. at 430 nm, Gain : X1
27.6 - 30.0 min	Ex. at 370 nm, Em. at 460 nm, Gain : X16
30.0 - 40.0 min	Ex. at 270 nm, Em. at 330 nm, Gain : X1
Cell Temp.	: 28 °C

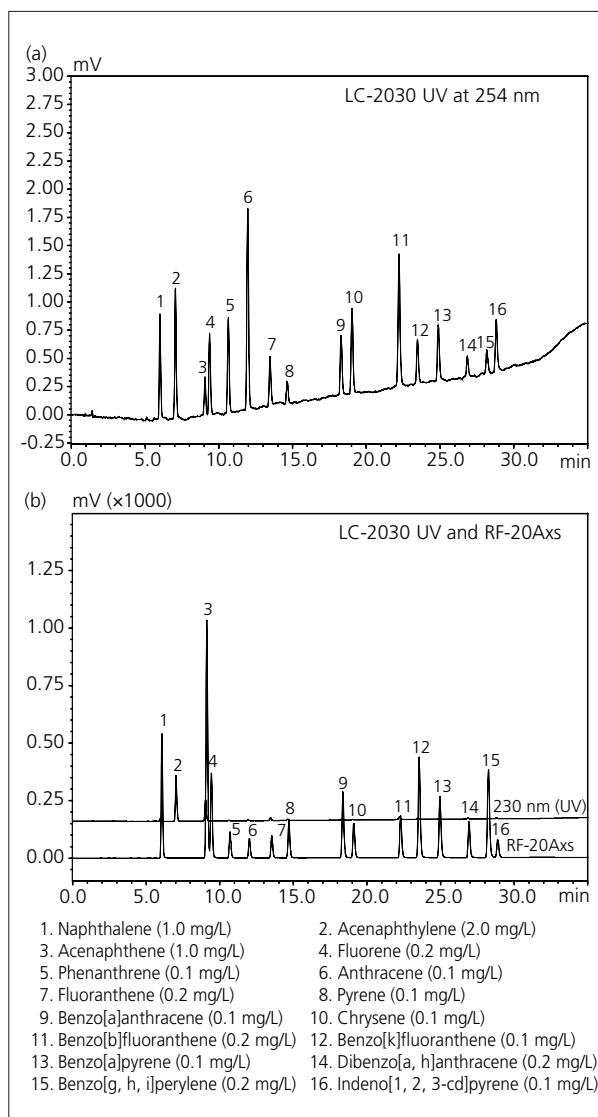

**Fig. 1 (a) UV Chromatogram of Standard Mixture of 16 PAHs (b) Chromatogram of Standard Mixture of 16 PAHs Analyzed by the RF-20Axs and UV Detector**

Note: The peak intensity of the chromatogram of Fig. 1 (b) is displayed as 10 times that of the actual chromatogram.



### ■ Analysis of Polycyclic Aromatic Hydrocarbons Using Simultaneous Multichannel Wavelength Mode

Fig. 2 shows the results of high-speed analysis of a standard mixture PAHs using the wavelength switching mode of the RF-20Axs fluorescence detector, and Table 3 shows the analytical conditions. Using these conditions, poor separation between "15. Benzo [g, h, i] perylene" and "16. Indeno [1, 2, 3-cd] pyrene" is evident in the vicinity of 13.5 minutes retention time. Next, Fig. 3 shows the results of analysis using the simultaneous multichannel wavelength mode of the RF-20Axs, and Table 4 shows the analytical conditions used. The results demonstrate that it is possible to achieve separation with high sensitivity and good selectivity even for components that are difficult to separate using the wavelength switching mode.

**Table 3 Analytical Conditions**

Column	: SUPELCO <sup>TM</sup> LC-PAH (100 mm L. × 3.0 mm I.D., 3 μm)
Mobile Phase	: A : Water B : Acetonitrile
Time Program	: B Conc. 50 % (0 - 2 min) → 100 % (13.5 - 14 min) → 50 % (14 - 15 min)
Flowrate	: 0.7 mL/min
Injection	: 5 μL
Column Temp.	: 40 °C
Detector	: UV at 230 nm RF-20Axs 0.0 - 10.0 min Ex. at 270 nm, Em. at 330 nm, Gain : X1 10.0 - 12.8 min Ex. at 250 nm, Em. at 370 nm, Gain : X1 12.8 - 16.0 min Ex. at 330 nm, Em. at 430 nm, Gain : X4 16.0 - 21.0 min Ex. at 270 nm, Em. at 390 nm, Gain : X1 21.0 - 27.6 min Ex. at 290 nm, Em. at 430 nm, Gain : X1 27.6 - 30.0 min Ex. at 370 nm, Em. at 460 nm, Gain : X16 30.0 - 40.0 min Ex. at 270 nm, Em. at 330 nm, Gain : X1
Cell Temp.	: 28 °C

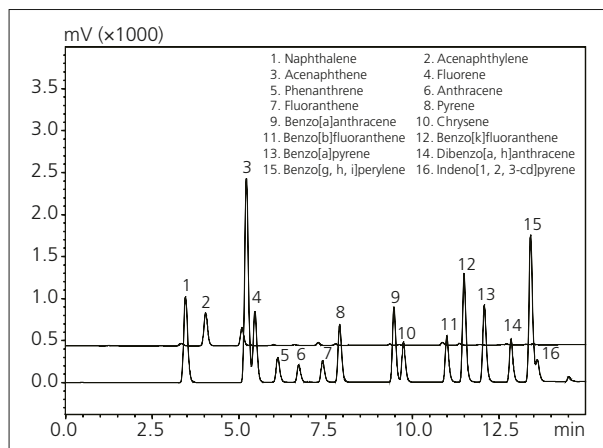
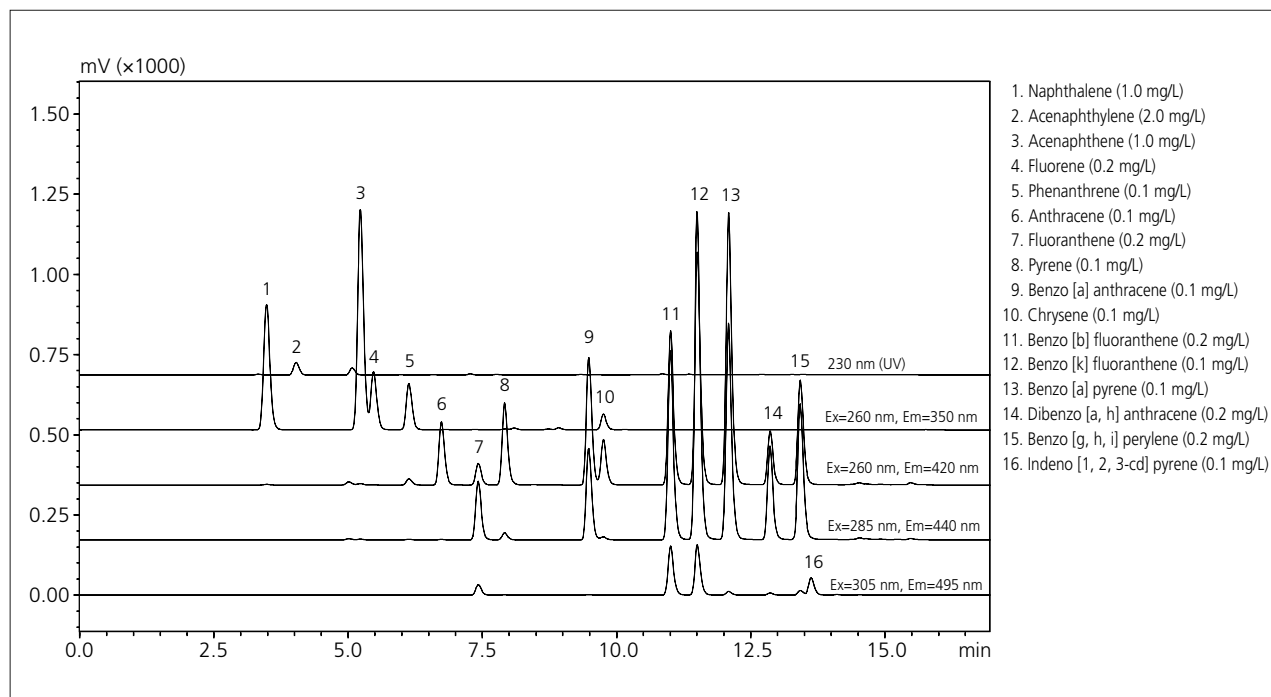

**Fig. 2 Rapid Analysis of 16 PAHs Standard Mixture by UV and Fluorescent Detector Using Wavelength Switching Mode**

Note: The peak intensity of the chromatogram of Fig. 1 (b) is displayed as 10 times that of the actual chromatogram.

**Table 4 Analytical Conditions**

Column Temp.	: 40 °C
Detector	: UV at 230 nm RF-20Axs Ex. at 260 nm, Em. at 350 nm Ex. at 260 nm, Em. at 420 nm Ex. at 285 nm, Em. at 440 nm Ex. at 305 nm, Em. at 495 nm
Cell Temp.	: 28 °C



**Fig. 3 Rapid Analysis of Standard Mixture of 16 PAHs Using Simultaneous Multichannel Wavelength Mode**

# Application News

## No.L477

### High Performance Liquid Chromatography

## Analysis of Anionic Surfactants by Prominence-i and RF-20Axs Fluorescence Detector

According to the Ministerial Ordinance on Water Quality Standards<sup>1)</sup>, an HPLC method using a fluorescence detector has been adopted as the test method for anionic surfactants<sup>2)</sup>. (Please refer to Application News No. L303.) Since either the RF-20A or RF-20Axs fluorescence detector can be connected to the new Prominence-i integrated high-performance liquid chromatograph, the combination of integrated operability and high-sensitivity fluorescence detection is possible.

Here we present an example of the analysis of five anionic surfactants using the Prominence-i integrated high-performance liquid chromatograph with the RF-20Axs high-sensitivity fluorescence detector.

#### ■ Analysis of Standard Anionic Surfactants

Fig. 1 shows the basic structural formula of the five anionic surfactants which differ by the length of the hydrocarbon chain. Quantitative analysis of anionic surfactants in water samples is conducted by classifying the approximately twenty peaks obtained from the analysis of a standard solution containing the C10 – C14 branched-chain surfactants, and then summing the respective area values.

Depending on the type of column used for separation, there is a type that can resolve branched chains for each carbon number and will produce multiple peaks, and there is a type which cannot resolve branched chains, so only a single peak appears for each carbon number.

Fig. 2 shows the chromatograms of a standard solution of anionic surfactants in accordance with the water quality inspection method (total of 50 mg/L for 5 substances, each at 10 mg/L), and Table 1 shows the analytical conditions used. This concentration is based on the standard concentration in accordance with the indicated pretreatment procedure (test water at 250-fold concentration).

Fig. 3 shows an example of high speed analysis using a commercially available column (which cannot resolve branched chains).

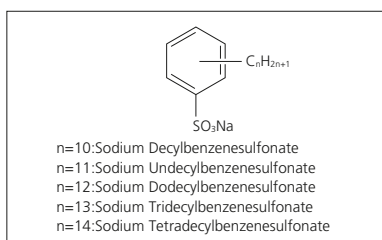

Fig. 1 Structure of Anionic Surfactants

Table 1 Analytical Conditions

Column (1)	: Shim-pack VP-ODS (250 mm L × 4.6 mm I.D., 5 μm)
Flowrate (1)	: 1.0 mL/min
Column (2)	: Wakosil AS-Aqua (250 mm L × 4.6 mm I.D., 5 μm)
Flowrate (2)	: 0.7 mL/min
Mobile Phase	: A) Water B) Acetonitrile containing 0.1 M Sodium Perchlorate
	: B. Conc. 65 %
Column Temp.	: 40 °C
Injection Volume	: 20 μL
Detection	: RF-20Axs, Ex at 221 nm, Em at 284 nm

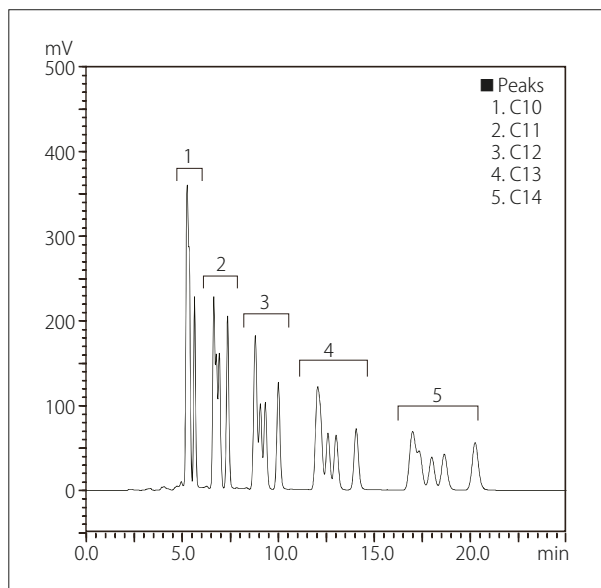

Fig. 2 Chromatogram of Standard Mixture of 5 Anionic Surfactants (Using Column 1) (10 mg/L each, total of 50 mg/L, 20 μL Inj.)

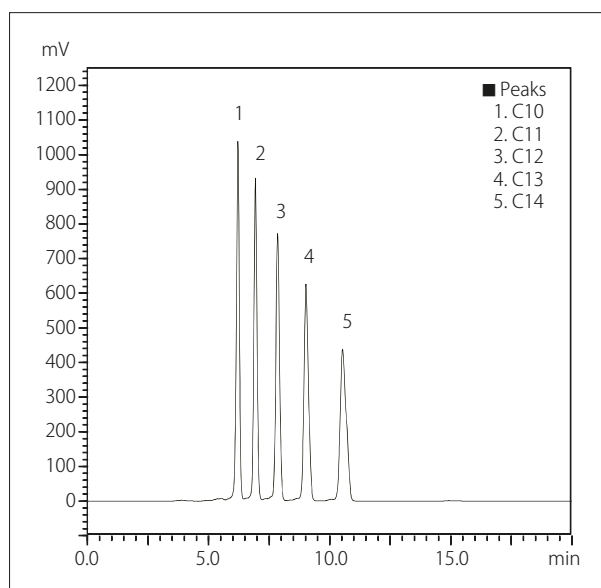

Fig. 3 Chromatogram of a Standard Mixture of 5 Anionic Surfactants (Using Column 2) (10 mg/L each, total of 50 mg/L, 20 μL Inj.)

### ■ Repeatability of Peak Area Values

Tables 2 and 3 show the peak area %RSD values obtained for each carbon number based on 6 repeat measurements of standard solutions of three anionic surfactants, each at a concentration of 1 mg/L and 5 mg/L. For all samples, the area %RSD was 0.6 % or less for both the 1 mg/L and 5 mg/L concentrations.

**Table 2 Reproducibility of Peak Area (%RSD) from Repeat Injections (Using Column 1)**

Upper: Standard Solution Containing 1 mg/L of Each Substance  
Lower: Standard Solution Containing 5 mg/L of Each Substance

Each at 1 mg/L (n=6)

	C10	C11	C12	C13	C14
%RSD	0.36	0.36	0.47	0.39	0.43

Each at 5 mg/L (n=6)

	C10	C11	C12	C13	C14
%RSD	0.31	0.31	0.31	0.26	0.30

**Table 3 Reproducibility of Peak Area (%RSD) from Repeat Injections (Using Column 2)**

Upper: Standard Solution Containing 1 mg/L of Each Substance  
Lower: Standard Solution Containing 5 mg/L of Each Substance

Each at 1 mg/L (n=6)

	C10	C11	C12	C13	C14
%RSD	0.39	0.41	0.38	0.60	0.34

Each at 5 mg/L (n=6)

	C10	C11	C12	C13	C14
%RSD	0.18	0.16	0.16	0.14	0.15

### ■ Analysis of Tap Water

The RF-20Axs high-sensitivity fluorescence detector features a temperature-controlled cell with a cooling function and is ideal for the direct injection of neat test water into the HPLC. The cell temperature control minimizes any fluorescence quenching at elevated or changing ambient temperature conditions.

Figs. 4 and 5 show examples of tap water analysis in which the undiluted samples were injected directly into the HPLC. In each pair of analysis results, the sample associated with the upper chromatogram consisted of tap water spiked with the five anionic surfactants subject to water quality standard limits (each 0.04 mg/L, total of 0.2 mg/L)<sup>1)</sup>. The lower trace is a water sample with no surfactants added. The analytical conditions are the same as those shown in Table 1.

In the Fig. 4 results from the column which resolves branched chains, a signal-to-noise ratio S/N=6 was obtained for the peak with the lowest intensity (third isomer of C14).

#### [References]

- 1) Ordinance No. 101 of Japan's Ministry of Health, Labour and Welfare, May 30, 2003, (Partially revised by Ordinance No. 11 of Ministry of Health, Labour and Welfare, January 28, 2011)
- 2) Ordinance No. 261 of Japan's Ministry of Health, Labour and Welfare, July 22, 2003, (Partially revised by Ordinance No. 290 of Ministry of Health, Labour and Welfare, March 30, 2012)

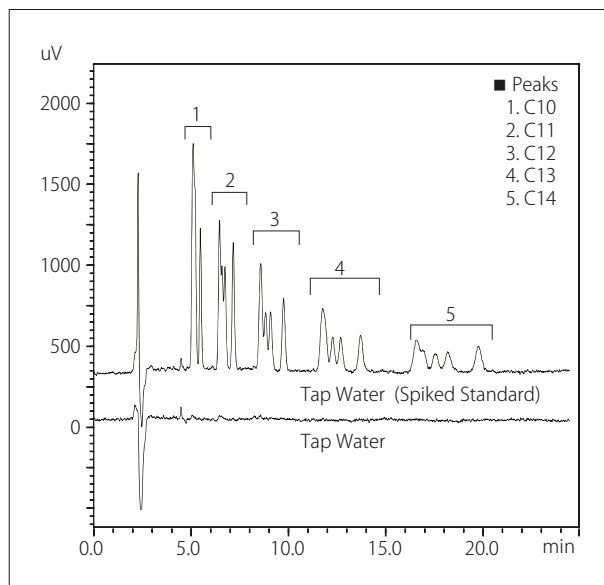

**Fig. 4 Chromatograms of Tap Water (20 µL Inj.) (Using Column 1)**  
Upper: Water, 0.04 mg/L each, total 0.2 mg/L spiked  
Lower: Water

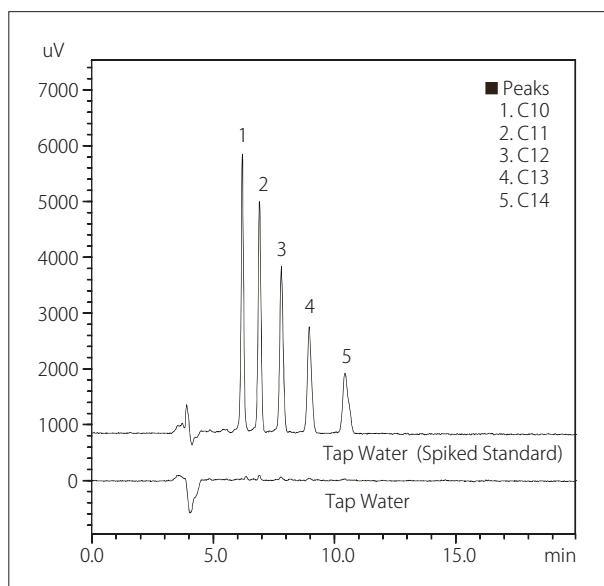

**Fig. 5 Chromatograms of Tap Water (20 µL Inj.) (Using Column 2)**  
Upper: Water, 0.04 mg/L each, total 0.2 mg/L spiked  
Lower: Water

# Analysis of Melamine and Its Related Substances in Fertilizers

Recently, it has been confirmed that some granulated products of hydrated calcium cyanamide, which are created by adding water to calcium cyanamide, contain a significant amount of melamine. Given this fact, while there are at present no standard values for melamine in fertilizer, regulations are being discussed, and investigations are progressing with respect to the dynamics of melamine in soil and its transition to crops.

This article introduces an example of the analysis of melamine and related substances in fertilizers using an HPLC system, with reference to the fertilizer test methods (2012) under the supervision of the Japan's Food and Agricultural Materials Inspection Center (FAMIC).  
(A. Uchida, T. Yamaguchi)

## ■ Analysis of Standard Solution

Fig. 1 shows the analysis results of a mixed standard solution containing melamine, ammeline, and ammelide (10 mg/L each, dissolved in a mixed solution of acetonitrile / water / diethylamine = 5/4/1 (v/v/v)) using an amide column. Table 1 shows the analytical conditions.

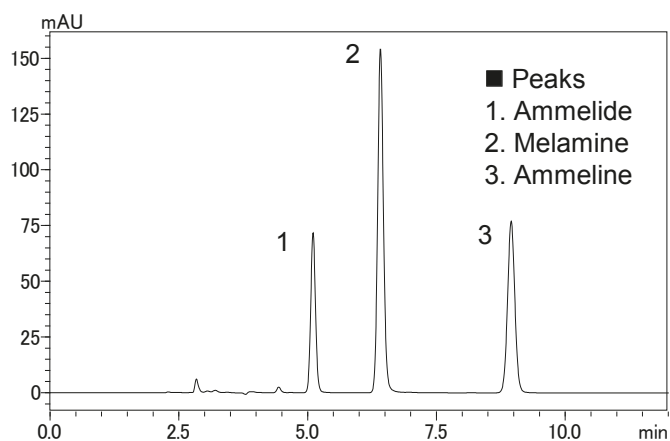

Fig. 1: Chromatogram of a Standard Mixture

Table 1: Analytical Conditions

Instrument:	Prominence HPLC system
Column:	Inertsil Amide (GL Sciences Inc., 250 mmL. × 4.6 mmI.D., 5 μm)
Mobile phase:	A) 5 mmol/L Phosphate buffer (pH 6.7) B) Acetonitrile A/B = 25/75 (v/v)
Flow rate:	1.0 mL/min
Column temp.:	40 °C
Detection:	SPD-20AV at 214 nm
Injection volume:	10 mL

## ■ Linearity and Repeatability

Fig. 2 shows the calibration curves for 3 components in the range of 0.1 mg/L to 20 mg/L. The contribution ratio ( $R^2$ ) was 0.999 or higher in all cases, indicating that favorable linearity was obtained. Calculating the detection limit and quantitation limit based on the absolute calibration curve for melamine in Fig. 2 yields 0.0005 mg/L and 0.0015 mg/L, respectively.

Table 2 shows the relative standard deviation (%RSD) for peak area in a 6-cycle repeated analysis of a mixed standard solution of melamine, ammeline, and ammelide (0.1 mg/L each). A favorable repeatability of 0.5 % max. was obtained for all components.

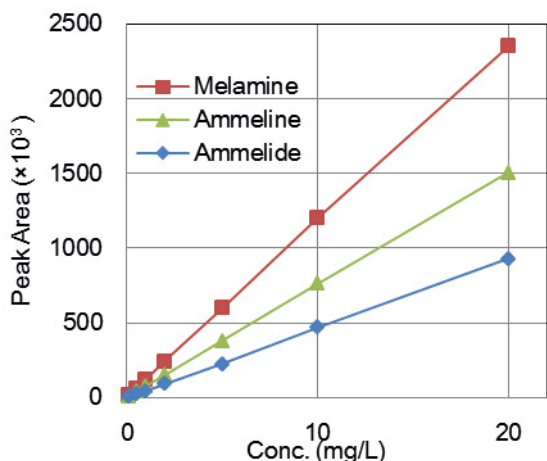

Fig. 2: Linearity (0.1 to 20 mg/L)

Table 2: Repeatability

	Melamine	Ammeline	Ammelide
1st	11921	7414	4590
2nd	11886	7364	4609
3rd	11899	7401	4603
4th	11906	7389	4649
5th	11915	7437	4625
6th	11910	7468	4606
%RSD	0.103	0.494	0.446

■ Analysis of Melamine and Its Related Substances in Fertilizers

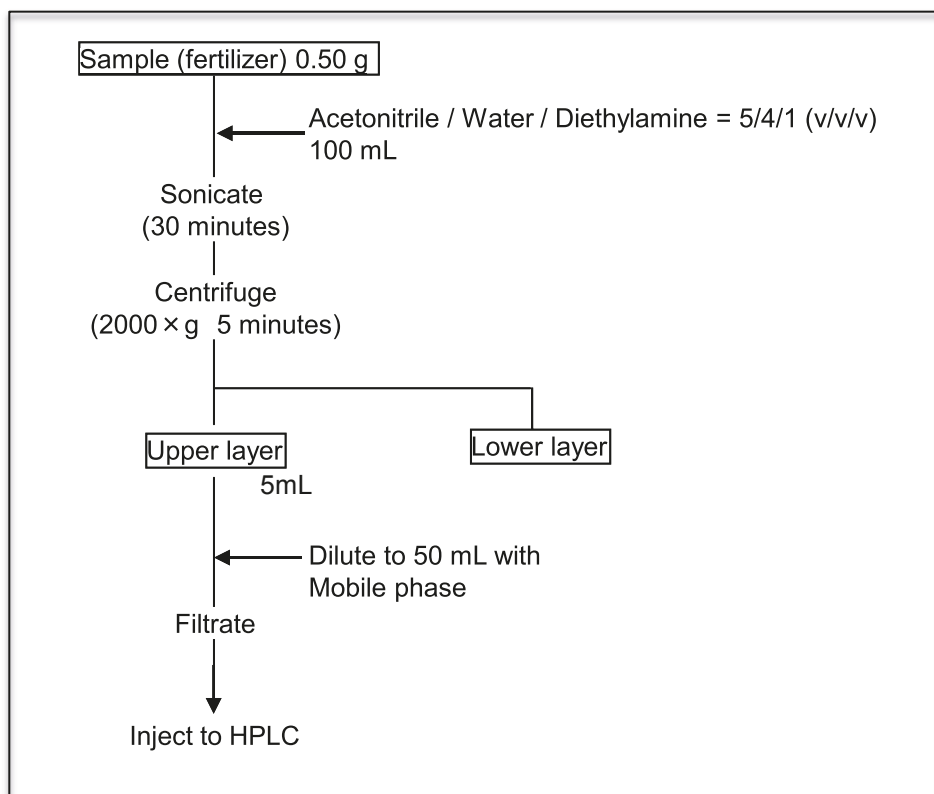

Fig. 3: Sample Preparation

Fig. 3 shows the sample preparation process described in the fertilizer test method. Fertilizer certified reference materials A and B\* were treated in accordance with the sample preparation procedure described in Fig. 3. The final solutions from the sample preparation were then spiked with melamine, ammeline, and ammeline with the standard addition technique so that the respective concentrations of these substances reached 10 mg/L. Figures 4 & 5 show the chromatograms obtained. The analysis conditions are the same as in Table 1. (In accordance with the sample preparation procedure in Fig. 3, if 100 % of the melamine and related substances were recovered, the content of these substances would be calculated as equivalent to a 2 % mass fraction with respect to the fertilizer.)

\*Fertilizer certified reference material A (FAMIC-A-10) is a high-analysis compound fertilizer containing urea. Fertilizer certified reference material B (FAMIC-B-10) is a general-compound fertilizer not containing urea. Both are commercially available from FAMIC.

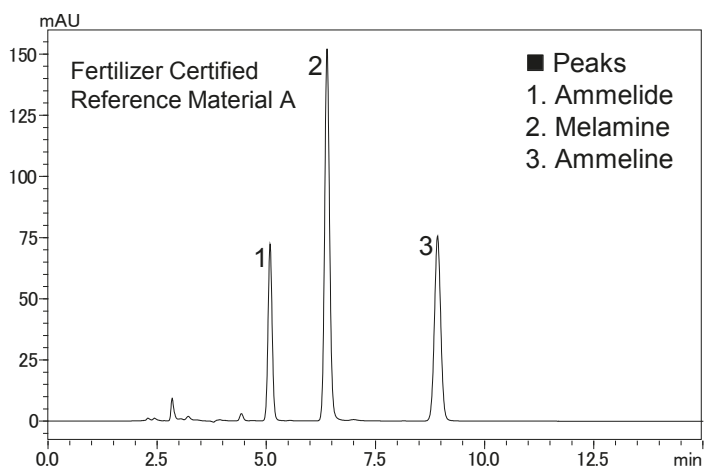

Fig. 4: Chromatogram of Fertilizer Certified Reference Material A (spiked with 10 mg/L melamine, ammeline and ammeline)

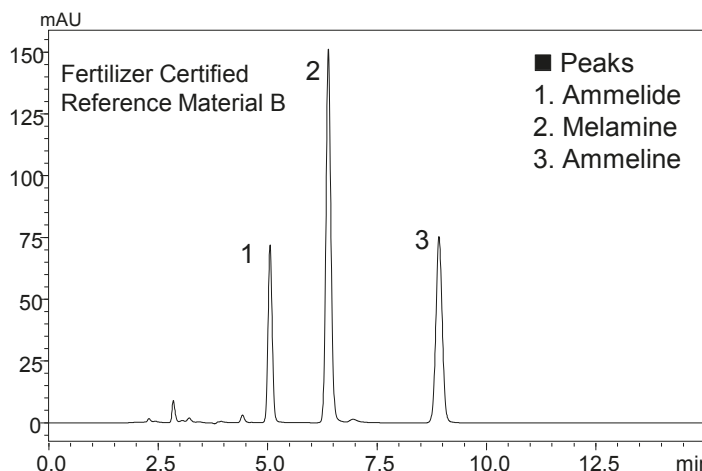

Fig. 5: Chromatogram of Fertilizer Certified Reference Material B (spiked with 10 mg/L melamine, ammeline and ammeline)



# Analysis of Dicyandiamide in Fertilizers

The dicyandiamide contained in calcium cyanamide is used as a type of nitrification suppressant to inhibit ammonia from changing into nitric acid. In accordance with the partial revision to the matters specifying official standards for general fertilizers based on the Fertilizers Regulation Act (The Ministry of Agriculture, Forestry and Fisheries of Japan; Notification No. 1985; dated August 8, 2012), the content of dicyandiamide-nitrogen in calcium cyanamide is to be 20.0 % or less of the total nitrogen content.

This article introduces an example of the analysis of dicyandiamide in fertilizer, with reference to the fertilizer test method (2012) under the supervision of the Japan's Food and Agricultural Materials Inspection Center (FAMIC).

(A. Uchida, T. Yamaguchi)

## ■ Analysis of Standard Solution

Fig. 1 shows the results of the analysis of a standard solution of dicyandiamide (10 mg/L, dissolved in methanol) using an amino column. The analytical conditions are shown in Table 1.

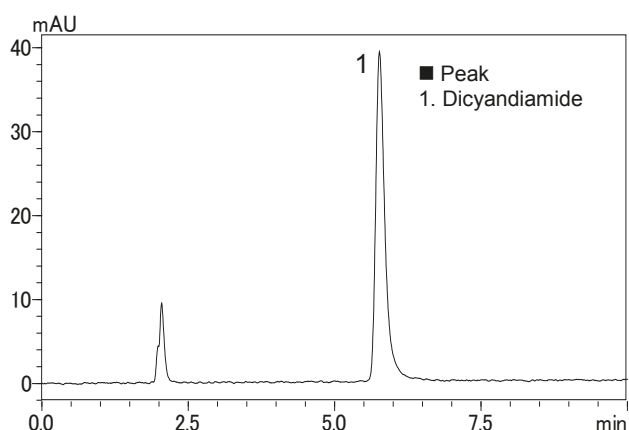

Fig. 1: Chromatogram of Dicyandiamide

Table 1: Analytical Conditions

Instrument:	Prominence HPLC system
Column:	Unison UK-Amino (Imtakt Corp., 150 mmL. × 4.6 mmI.D., 3 μm)
Mobile phase:	Acetonitrile / Methanol = 6/1 (v/v)
Flow rate:	1.0 mL/min
Column temp.:	40 °C
Detection:	SPD-20AV at 214 nm
Injection volume:	5 μL

## ■ Linearity and Repeatability

Fig. 2 shows the calibration curve for dicyandiamide in the range of 1 mg/L to 50 mg/L. The contribution ratio ( $R^2$ ) was 0.999 or higher, indicating that favorable linearity was obtained. Calculating the detection limit and quantitation limit based on the absolute calibration curve for dicyandiamide in Fig. 2 yields 0.15 mg/L and 0.46 mg/L, respectively. Table 2 shows the relative standard deviation ( $n=6$ ) for the peak area for each component when the dicyandiamide standard solution (1 mg/L) was analyzed. Favorable results were obtained, with a relative standard deviation of 0.48 %.

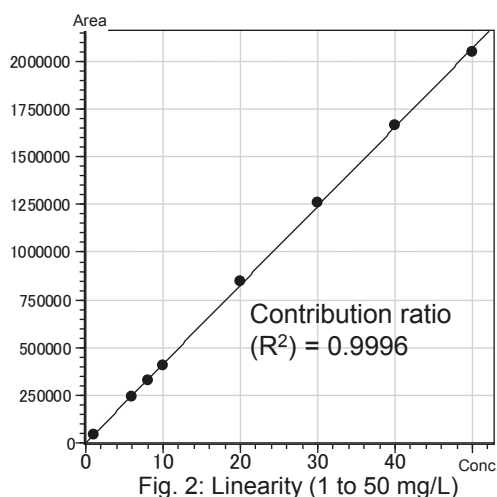

Fig. 2: Linearity (1 to 50 mg/L)

Table 2: Repeatability

	Standard solution 1 mg/L
1st	41511
2nd	41543
3rd	41107
4th	41561
5th	41143
6th	41482
%RSD	0.479

■ Analysis of Dicyandiamide in Fertilizers

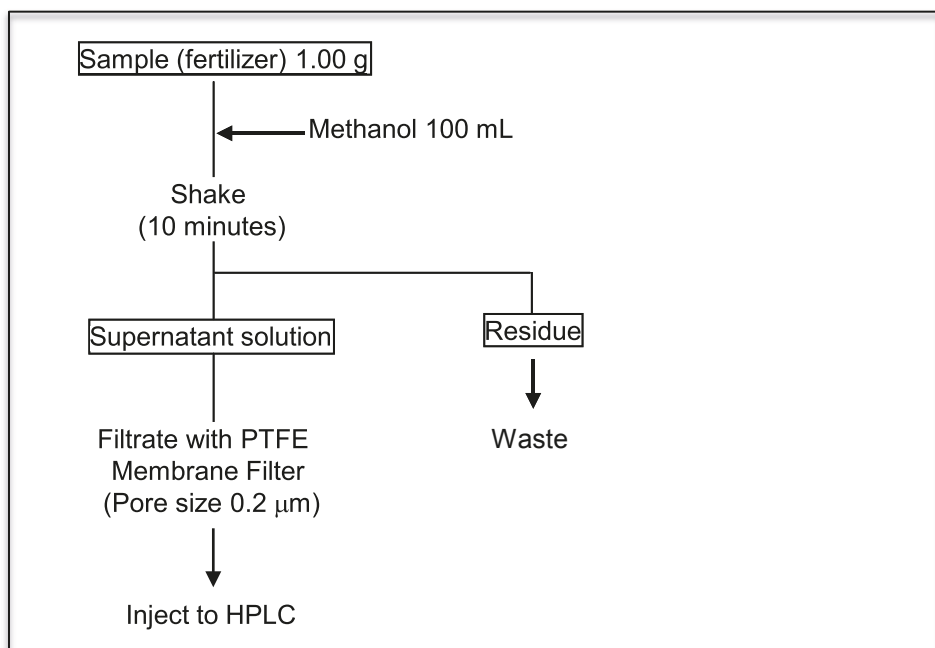

Fig. 3: Sample Preparation

Fig. 3 shows the sample preparation process described in the fertilizer test method. Fertilizer certified reference materials A and B\* were treated in accordance with the sample preparation procedure described in Fig. 3. The final solutions from the sample preparation were then spiked with dicyandiamide with the standard addition technique so that the concentrations of dicyandiamide reached 10 mg/L. Figures 4 & 5 show the chromatograms obtained. The analysis conditions are the same as in Table 1. (In accordance with the sample preparation procedure in Fig. 3, if 100 % of the dicyandiamide was recovered, its content would be calculated as equivalent to a 0.1 % mass fraction with respect to the fertilizer.)

\*Fertilizer certified reference material A (FAMIC-A-10) is a high-analysis compound fertilizer containing urea. Fertilizer certified reference material B (FAMIC-B-10) is a general-compound fertilizer not containing urea. Both are commercially available from FAMIC.

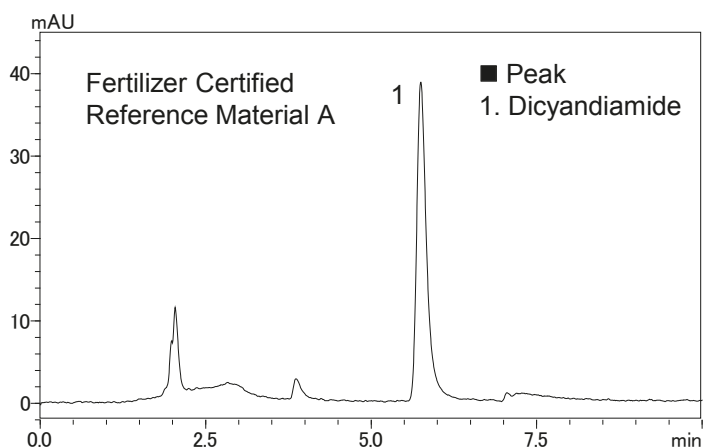

Fig. 4: Chromatogram of Fertilizer Certified Reference Material A (spiked with 10 mg/L dicyandiamide)

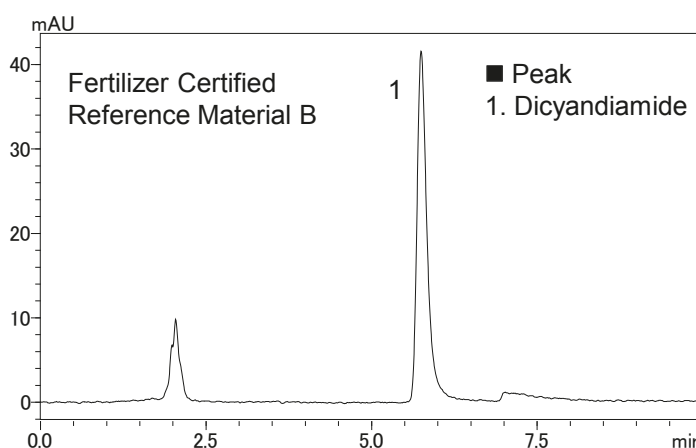
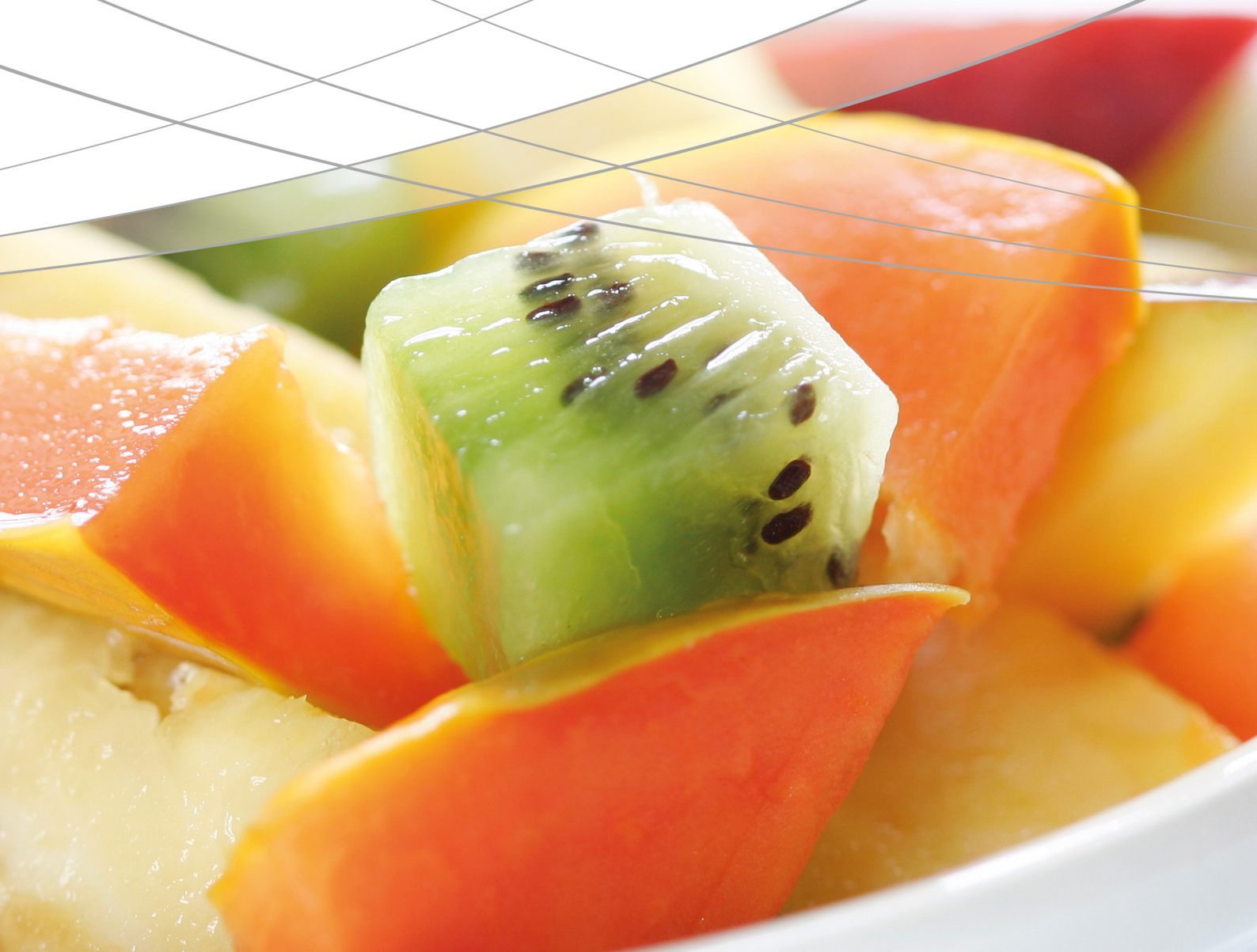

Fig. 5: Chromatogram of Fertilizer Certified Reference Material B (spiked with 10 mg/L dicyandiamide)

# 3. Food, Beverages & Agriculture





---

## 3. Food, Beverages & Agriculture

---

Regarding food, water, beverages and agricultural cropland, the increasing world population is one of the biggest challenges of mankind. How can access be provided to sufficient and safe food as well as clean water? How can crop failure be prevented? Can new food sources be explored?

In industrial nations, the percentage of convenience food has been increasing. How can new ingredients be discovered to replace existing ones regarding calories, fat and flavoring substances in order to support a healthier life?

### Food and beverages industries

In food and beverages industries, analytical instrumentation methods are essential to ensure high product quality during several steps in the manufacturing process, such as quality control of raw materials (e.g. natural products) as well as their treatment during and after production. Whether it is the analysis of degradation of edible oils or the vitamins in baby food, the quantification of food additives or pesticide residues, the quality control of packaging materials concerning color and possible contaminants or the determination of distinct aromas found in natural products – high-throughput food and beverage QA/QC laboratories require high-speed and high-quality analysis.

The quality of food is not only about its ingredients and raw materials, but also about its texture which complements the experience in the moment of consumption. Crispness, gumminess, softness, hardness are all important properties which enhance the taste sensation when people eat.

### Agriculture

While the agriculture industry undergoes a shift from natural crop development to the use of biological agents, the fundamental mission of the industry remains the same: providing the world with healthy products. To ensure the health of crops, reliable instruments are needed that provide accurate, timely data on such critical areas as water supply, soil composition and animal feed.

### Nutraceuticals

The natural products industry has undergone a tremendous amount of growth in the last decade. With this dynamic growth, there has been a surge of regulations to monitor the development process and ensure the safety of the end product, e.g. regarding herbs, botanicals, supplements and organic foods.

Shimadzu's broad range of analytical instruments provide the food, beverages and agricultural industries with leading technologies in chromatography (HPLC, GC, SFC), mass spectrometry (GC-MS, LC-MS, MALDI), sum parameter (TOC), spectroscopy (UV-VIS, FTIR, AAS, ICP-OES, EDX) and material testing. Based on most modern hardware and software, Shimadzu's systems can be used in highly regulated environments and are compliant with regulations such as FDA 21 CFR Part 11 and GLP.

Find more information on:  
[www.shimadzu.eu/food-beverages-agriculture](http://www.shimadzu.eu/food-beverages-agriculture)





---

## 3. Food, Beverages & Agriculture

---

### Nexera UC SFE-GCMS

L502 Analysis of residual pesticides in agricultural products using Nexera UC off-line SFE-GC/MS system

### Nexera UC SFE-SFC

L497 Using the Nexera UC online SFE-SFC-MS system to analyze residual pesticides in agricultural products  
L501 Analysis of vitamin E in a commercial supplement by offline SFE-SFC-PDA

### Nexera X2-PDA

L421 Analysis of artificial colorings  
SCA\_190\_015 UHPLC assay for stevia glycosides

### Nexera X2-RF

35 High-speed analysis of amino acids and histamine in fish sauce via automated OPA pre-column derivatization  
L430 Analysis of aflatoxins in food by Nexera UHPLC  
L432 Analysis of pre-column derivatized amino acids  
L449 Analysis of pre-column derivatized biogenic amines

### Nexera-e (2D LC)

C190-E178 LC×LC-PDA-MS/MS for polyphenol analysis in red wine  
L491 Comprehensive 2D separation of carotenoids in red chili pepper by the Nexera-e system  
L492A Comprehensive 2D separation of triglycerides in vegetable oil with ELSD/LCMS-IT-TOF detection

### Nexera-i RF

L500 Analysis of aflatoxin B1, B2, G1 and G2 in kakkonto using Nexera-i and RF-20AXS

### Prominence-i

L484 Analysis of nivalenol and deoxynivalenol in wheat

### Prominence-i RID

L481 Analysis of sugars and sugar alcohols in energy drink by Prominence-i with RID

### Prominence-PDA

SCA\_190\_025 Analysis of phenoxyethanol, sorbic acid and sodium dehydroacetate

### Prominence-RF

L463 Analysis of histamine and tyramine in food products



# Application News

## No.L502

### Supercritical Fluid Extraction / Chromatography

## Analysis of Residual Pesticides in Agricultural Products Using Nexera UC Off-Line SFE-GC/MS System

Since enforcement of the positive list system for residual pesticides in foods in 2006 in Japan, over 800 pesticides have been included in the system. Consequently, there is now a strong demand for effective analytical methods encompassing any sample pretreatment steps that are capable of inspecting large numbers of pesticides. Conventionally, analysis of residual pesticides in foods has involved pesticide extraction by a solvent extraction method before analysis by LC/MS or GC/MS. The problem with solvent extraction methods is that sample pretreatment requires a substantial amount of time and effort, and large quantities of organic solvents are used. Supercritical fluid extraction (SFE) that uses supercritical carbon dioxide as the extraction solvent provides good extraction efficiency, where the solvent is similar to gas in terms of low viscosity and high diffusivity, and similar to fluid in terms of high solubility. This allows for extraction within a short period of time. This extraction method is also less damaging to the environment since it uses a smaller amount of organic solvent compared to conventional solvent extraction methods. We introduce an example GC/MS analysis of pesticides extracted from an agricultural products using the Nexera UC off-line SFE system.

### Off-Line SFE System

Fig. 1 shows the principle behind operation of the Nexera UC off-line SFE system. An extraction vessel filled with a sample is placed in the SFE unit, and is heated to 40 °C (Fig. 1 A). The extraction vessel is then filled with supercritical carbon dioxide, and the target components are extracted statically without pumping the liquid (Fig. 1 B). After static extraction, dynamic extraction is performed by pumping supercritical carbon dioxide through the extraction vessel (Fig. 1 C). After trapping the extract material in the trap column, eluate that contains the target components is then collected in the fraction collector (Fig. 1 D).

### Sample Preparation

The QuEChERS method that prioritizes simplicity and speed is widely used to pretreat agricultural products for residual pesticide analysis. While there is a special kit available for the QuEChERS method, sample preparation for this kit requires a large number of process steps including reagent addition, solvent extraction, purification by dispersive solid phase extraction, and centrifugal separation.

Meanwhile, as shown in Fig. 2, sample preparation for the Nexera UC off-line SFE system only involves mixing 1 g of agricultural product pulverized in a mixer with 1 g of dehydrating agent\*, then filling the extraction vessel with this mixture. This not only results in improved productivity and a reduced environmental burden, but also avoids human errors involved in the sample pretreatment process. Using a specially designed rack changer also allows for extraction of a maximum of 48 samples consecutively.

\* "Miyazaki Hydro-Protect" Patent No. 3645552

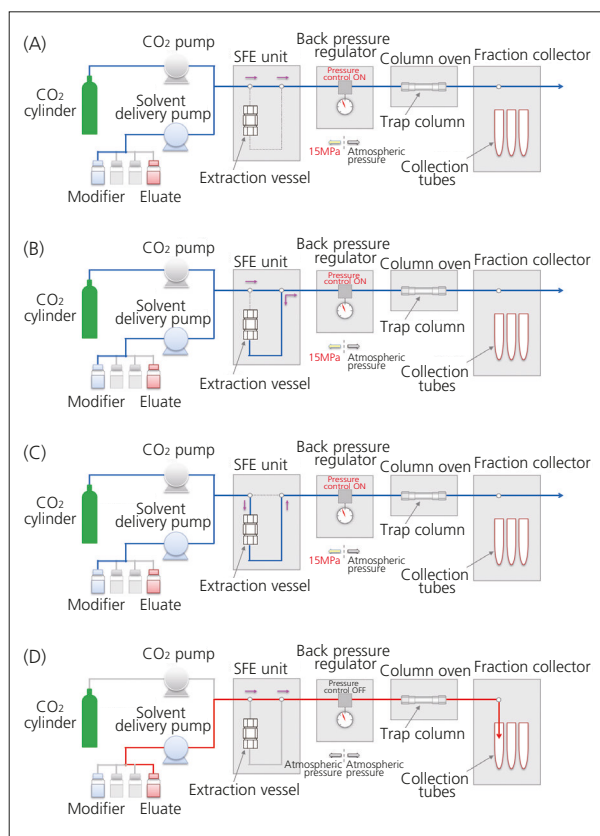

Fig. 1 Flow of Off-Line SFE Extraction

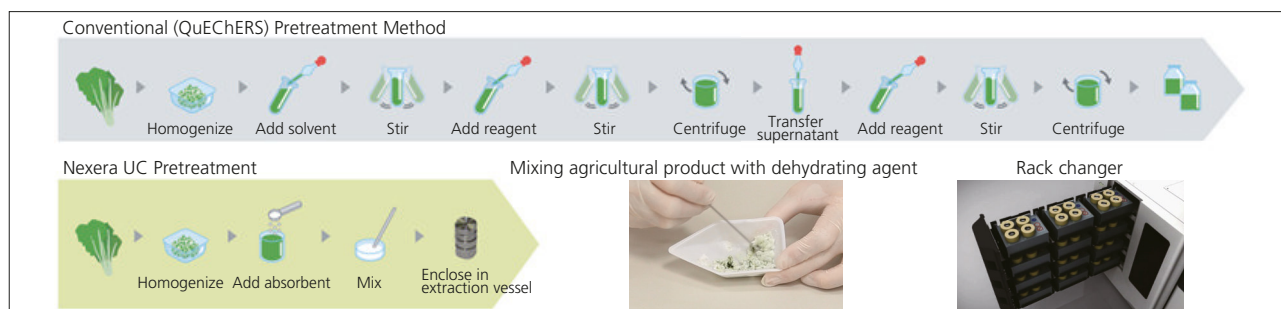

Fig. 2 Sample Preparation

**Table 1 Analytical Conditions**

[SFE] Nexera UC SFE System	[GC-MS] GCMS-TQ8040
Extraction : A) Supercritical fluid of CO <sub>2</sub>	Column : Rxi®-5Sil MS 30 m × 0.25 mm I.D., df = 0.25 μm
Solvent : B) Methanol	Column Temp. : 50 °C (1 min) → (25 °C/min) → 125 °C → (10 °C/min) → 300 °C (15 min)
Flowrate : 5 mL/min	Carrier Gas : He (Constant linear velocity mode)
Extraction : 8 min (Static mode → Dynamic mode)	Linear Velocity : 47.2 cm/sec
Extraction Vessel Temp. : 40 °C	Injection Mode : Splitless (Sampling time 1.00 min)
BPR Pressure : 15 MPa	High Press Inj. : 250 kPa (1.5 min)
Trap Column : Shim-pack VP-ODS (50 mm L. × 4.6 mm I.D., 5 μm)	Injection Volume : 1 μL
Elution Solvent : Acetone/Hexane = 50/50 (2 mL/min, 2 min)	Interface Temp. : 250 °C
	Ion Source Temp.: 200 °C
	MS Mode : MRM
	Loop Time : 0.3 sec

■ **Analysis of Brown Rice**

A mixed standard solution of pesticides for GC/MS analysis (Hayashi Pure Chemical PL2005 Pesticide GC/MS Mix I-VI, 7) was added to pulverized brown rice to a concentration of 100 ng/g, and SFE was performed using the conditions shown in Table 1. The extraction liquid obtained was made up to 2 mL using eluate, and analyzed by GC/MS. The MRM chromatogram obtained from GC/MS analysis is shown in Fig. 4. Good repeatability (relative standard deviation of quantitation concentration <10 %) and recovery (70-120 %) were obtained for the 301 components. Repeatability and recovery for the 301 pesticides are shown in Table 2. This system uses a very simple pretreatment process, and can perform automated extraction from a single sample in approximately 30 minutes.

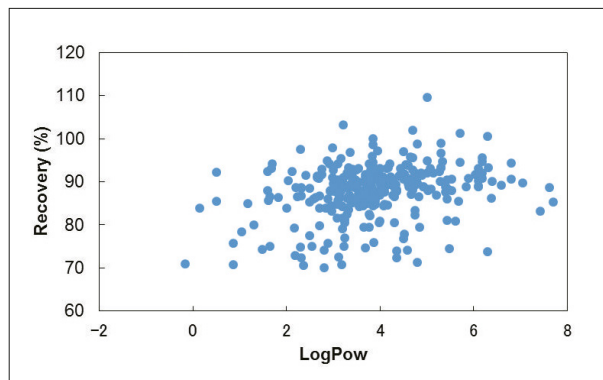

**Fig. 3 Recovery in Brown Rice Analysis**

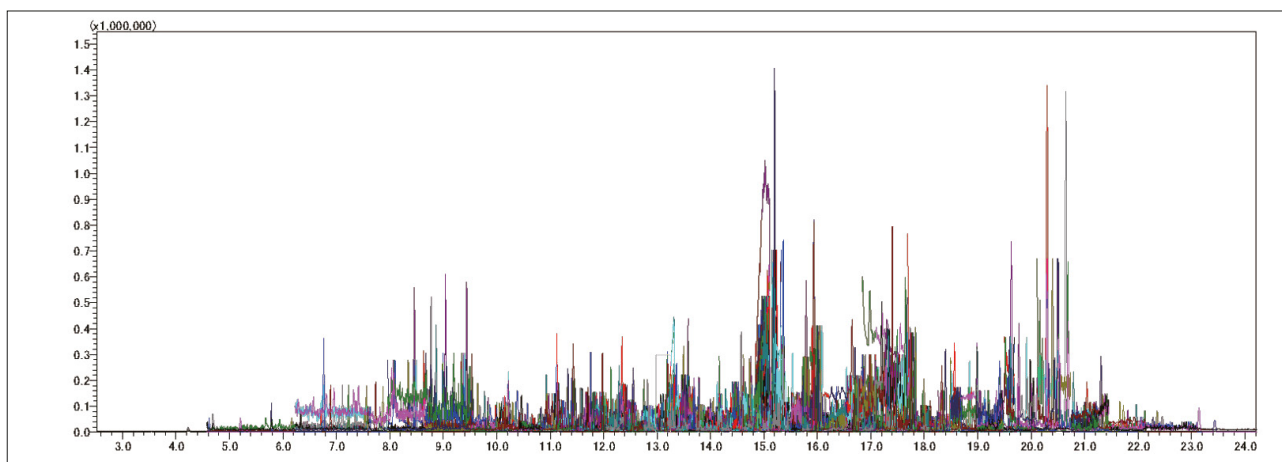

**Fig. 4 MRM Chromatogram of Extraction Liquid from Brown Rice**

**Table 2 Repeatability and Recovery**

Compounds	Repeatability (%RSD, n = 6)	Recovery (%)	Compounds	Repeatability (%RSD, n = 6)	Recovery (%)
2-Phenylphenol	3.8	87.0	Azinphos-ethyl	5.3	84.3
Acetochlor	5.9	93.1	Azinphos-methyl	2.7	83.1
Acrinathrin-1	6.8	73.8	Benalaxyl	7.0	84.9
Acrinathrin-2	3.1	100.6	Benfluralin	5.2	90.1
Alachlor	3.6	88.7	Benfuresate	4.1	91.5
Allethrin-3,4	5.9	102.0	Benoxacor	3.2	90.8
Allidochlor	5.3	86.4	beta-BHC	5.3	87.8
alpha-BHC	4.6	88.9	beta-Endosulfan	6.5	90.7
alpha-Endosulfan	9.5	98.7	Bifenox	4.1	84.5
Ametryn	4.1	86.3	Bifenthrin	3.3	89.2
Anilofos	4.7	86.3	Biphenyl	3.5	80.5
Atrazine	4.8	86.7	Bromobutide	4.6	90.4
Azaconazole	5.5	70.5	Bromophos	5.4	90.1
Azamethiphos	9.9	78.4	Bromophos-ethyl	6.0	86.6

Table 2 Repeatability and Recovery (continued)

Compounds	Repeatability (%RSD, n = 6)	Recovery (%)	Compounds	Repeatability (%RSD, n = 6)	Recovery (%)
Bromopropylate	4.1	90.9	Diphenamid	5.7	79.3
Bromuconazole-1	3.7	80.5	Diphenylamine	3.1	91.5
Bromuconazole-2	5.3	77.1	Disulfoton sulfone	5.2	85.0
Bupirimate	7.9	86.8	Ditalimfos	3.2	90.1
Buprofezin	6.6	88.8	Dithiopyr	5.1	90.9
Butachlor	6.4	91.6	Edifenphos	3.5	95.9
Butafenacil	4.4	90.4	Endosulfan sulfate	6.9	95.4
Butamifos	3.8	90.1	EPN	3.8	88.0
Butylate	4.6	84.7	Epoxiconazole	3.7	83.9
Cadusafos	4.1	88.1	EPTC	4.3	81.6
Cafenstrole	5.1	91.1	Esprocarb	2.7	90.6
Captan	9.1	77.6	Ethalfuralin	5.3	93.3
Carbofuran	4.7	83.3	Ethion	3.4	93.1
Carbophenothion	2.9	91.5	Ethofumesate	5.7	91.4
Carfentrazone-ethyl	4.1	96.8	Ethoprophos	4.3	91.0
Chinomethionat	4.2	82.1	Etobenzanid	3.8	86.6
Chlormethoxyfen	5.8	89.8	Etofenprox	3.8	89.7
Chlorbenside	3.9	81.1	Etoazole	8.2	87.9
Chlorbufam	4.2	84.7	Etridiazole	3.8	85.3
Chlorethoxyfos	4.6	90.3	Etrimfos	2.9	87.9
Chlorfenapyr	7.5	86.5	Famoxadone	5.4	71.2
Chlorfenson	7.7	91.4	Fenamidone	5.7	70.1
Chlorfenvinphos-(E)	4.4	91.2	Fenclorphos	6.0	92.1
Chlorfenvinphos-(Z)	6.5	88.7	Fenitrothion	6.9	88.7
Chlormephos	3.1	89.6	Fenothiocarb	5.4	88.6
Chlorobenzilate	3.6	92.0	Fenoxanil	6.2	88.2
Chloroneb	6.0	95.0	Fenoxaprop-ethyl	4.1	90.5
Chlorothalonil	5.3	87.7	Fenoxycarb	6.9	84.4
Chlorpropham	4.9	88.5	Fenpropathrin	3.7	91.6
Chlorpyrifos	6.2	90.8	Fenpropimorph	4.7	76.8
Chlorpyrifos-methyl	5.1	90.5	Fenthion	3.6	79.5
Chlorthiophos-2	9.5	88.4	Fenvalerate-1	5.2	88.4
Chlorthiophos-3	2.8	92.8	Fenvalerate-2	4.2	95.0
Chlozolinate	7.8	82.4	Fipronil	8.3	86.7
Cinidon-ethyl	4.3	88.8	Flamprop-methyl	6.6	85.7
Cinmethylin	9.9	94.5	Fluacrypyrim	6.8	97.0
Clomazone	4.2	88.6	Flucythrinate-1	4.0	92.8
Clomeprop	3.3	89.8	Flucythrinate-2	3.7	95.7
Crimidine	6.0	80.0	Flufenpyr-ethyl	1.8	98.0
Cyanofenphos	4.7	91.8	Flumiclorac-pentyl	5.8	91.8
Cyanophos	5.0	91.3	Flumioxazin	9.4	75.0
Cyflufenamid	8.4	89.6	Fluquinconazole	4.3	81.2
Cyfluthrin-1	5.1	95.6	Flusilazole	5.5	86.8
Cyfluthrin-2	3.5	94.6	Fluthiacet-methyl	3.8	79.5
Cyfluthrin-3	4.9	92.0	Flutolanil	9.6	87.8
Cyfluthrin-4	6.0	90.8	Fluvalinate-1	2.6	100.0
Cyhalofop-butyl	4.2	93.4	Fluvalinate-2	2.6	98.6
Cyhalothrin-1	9.1	90.6	Folpet	5.3	87.7
Cyhalothrin-2	4.5	94.4	Fonofos	3.8	91.7
Cypermethrin-1	2.8	99.0	Formothion	5.3	74.4
Cypermethrin-2	3.7	96.6	Fosthiazate-2	9.6	93.2
Cypermethrin-3	3.7	93.2	Furilazole	3.3	92.4
Cypermethrin-4	8.4	93.2	gamma-BHC	4.1	88.7
Cyprodinil	4.0	80.9	Halfenprox	2.3	85.4
delta-BHC	2.2	88.2	Hexaconazole	8.9	85.6
Deltamethrin-2	3.7	103.2	Indanofan	7.9	86.5
Dialifos	3.2	91.4	Indoxacarb	3.7	95.7
Di-allate-1	2.5	91.5	Iprobenfos	4.4	89.5
Di-allate-2	4.7	92.0	Iprodione	2.5	92.7
Diazinon	7.8	90.0	Iprodione metabolite	3.1	106.2
Dichlobenil	4.0	79.8	Isazofos	3.7	94.2
Dichlofenthion	5.2	92.1	Isocarbophos	6.6	84.0
Dichlofluanid	3.3	87.2	Isofenphos	3.2	89.0
Dichlorvos	3.2	83.9	Isofenphos oxon	5.2	84.5
Diclobutrazol	5.2	87.0	Isoprocarb	4.5	86.6
Diclocymet-1	4.3	83.4	Isoprothiolane	7.5	86.1
Diclocymet-2	5.1	82.2	Isoxadifen-ethyl	5.0	90.5
Diclofop-methyl	4.4	91.0	Isoxathion	6.7	93.2
Diethofencarb	4.8	83.8	Kresoxim-methyl	7.0	89.7
Difenoconazole-1	5.5	74.0	Leptophos	3.5	93.3
Difenoconazole-2	5.2	72.4	Malathion	3.2	93.0
Diflufenican	4.4	94.3	MCPB-ethyl	3.5	90.3
Dimepiperate	2.5	87.8	Mecarbam	8.4	97.6
Dimethametryn	6.4	84.8	Mefenacet	4.5	75.1
Dimethenamid	5.4	88.8	Mefenpyr-diethyl	5.0	90.4
Dimethipin	9.9	70.9	Mepronil	4.2	79.5
Dimethylvinphos-(E)	4.5	86.8	Metalaxyl	7.0	86.6
Dimethylvinphos-(Z)	4.9	86.1	Methacrifos	5.9	92.3
Diniconazole	2.3	80.6	Methidathion	4.5	86.0
Dioxabenzofos	4.4	91.5	Methoprene	8.8	109.6
Dioxathion	5.4	88.6	Methoxychlor	3.1	90.6
Dioxathion deg.	4.4	86.1	Metolachlor	2.9	91.1

Table 2 Repeatability and Recovery (continued)

Compounds	Repeatability (%RSD, n = 6)	Recovery (%)	Compounds	Repeatability (%RSD, n = 6)	Recovery (%)
Metominostrobin-(E)	9.6	72.4	Simazine	5.2	74.9
Metribuzin	6.5	75.1	Simeconazole	6.1	79.1
Mevinphos-1	9.9	92.3	Simetryn	5.0	74.1
Mevinphos-2	6.0	85.4	Spirodiclofen	4.6	94.1
Molinate	3.8	86.0	Sulfotep	3.9	92.9
Myclobutanil	5.9	75.7	Sulprofos	4.8	74.5
Naled	6.1	72.8	Swep	5.3	83.6
Nitralin	4.5	94.2	Tebufenpyrad	3.6	88.8
Nitrofen	8.1	88.9	Tebupirimfos	4.6	89.4
Nitrothal-isopropyl	2.4	90.2	Tecnazene	3.1	89.5
Oxabetrinil	3.4	91.7	Tefluthrin	4.5	90.1
Oxadiazon	3.9	94.7	Terbucarb	4.0	87.6
Oxpoconazole	6.4	74.7	Terbufos	3.8	77.9
Oxpoconazole-formyl deg.	9.9	88.9	Terbutryn	4.5	86.0
Oxyfluorfen	8.9	88.3	Tetrachlorvinphos	3.2	93.0
Paclobutrazol	7.5	72.6	Tetraconazole	7.8	84.3
Parathion	6.3	90.1	Tetradifon	5.9	89.5
Parathion-methyl	5.1	90.4	Tetramethrin-1	6.9	93.8
Penconazole	4.7	85.0	Tetramethrin-2	4.3	90.9
Pendimethalin	5.1	86.9	Thenylchlor	3.5	87.3
Pentoxazone	4.2	95.6	Thifluzamide	5.9	84.6
Permethrin-1	4.8	89.0	Thiobencarb	3.5	85.6
Permethrin-2	4.0	88.8	Tolclofos-methyl	3.9	90.6
Phenothrin-1	7.4	93.1	Tolfenpyrad	3.6	81.0
Phenothrin-2	2.5	90.2	Tolyfluanid	5.8	91.1
Phenthoate	2.4	91.7	Triadimefon	3.7	88.3
Phorate	4.1	75.9	Triadimenol-1	6.2	70.8
Phosalone	3.5	88.1	Tri-allate	5.3	91.2
Phosmet	4.2	84.5	Triazophos	4.7	89.9
Phosphamidon-1	8.6	75.8	Tribufos	6.2	90.6
Phosphamidon-2	6.6	70.8	Trichlamide	5.2	85.3
Picolinafen	4.0	90.4	Trifloxystrobin	5.9	90.7
Piperonyl butoxide	3.8	89.2	Trifluralin	3.2	92.5
Piperophos	3.5	88.9	Vinclozolin	4.2	89.6
Pirimiphos-methyl	5.7	90.8	XMC	3.9	86.5
Pretilachlor	5.6	89.8	Xylylcarb	4.5	85.3
Procymidone	7.0	91.6	Zoxamide	3.6	82.6
Profenofos	5.6	94.1			
Prohydrojasmon-1	5.5	87.7			
Prohydrojasmon-2	8.7	88.6			
Prometryn	3.0	86.8			
Propachlor	4.4	88.0			
Propargite-1	9.3	101.3			
Propargite-2	9.5	94.5			
Propazine	4.0	97.1			
Propiconazole-1	6.7	89.4			
Propiconazole-2	3.2	88.3			
Propoxur	5.3	83.9			
Propyzamide	4.2	81.6			
Prothiofos	4.0	85.5			
Pyraclufos	5.1	94.1			
Pyraclostrobin	4.7	93.1			
Pyraflufen-ethyl	4.7	92.7			
Pyrazophos	4.2	92.8			
Pyrazoxyfen	9.4	91.2			
Pyributicarb	3.1	88.1			
Pyridaben	3.1	86.1			
Pyridaphenthion	5.4	84.2			
Pyrifenox-(E)	5.9	85.2			
Pyrifenox-(Z)	7.3	92.9			
Pyrimethanil	6.0	83.9			
Pyrimidifen	4.9	74.2			
Pyriminobac-methyl-(E)	3.9	88.6			
Pyriminobac-methyl-(Z)	5.2	88.6			
Pyriproxyfen	5.7	92.1			
Quinalphos	3.3	93.2			
Quinoxifen	3.2	87.1			
Quintozene	6.0	90.3			
Quizalofop-ethyl	3.0	86.9			
Resmethrin-1	6.2	88.5			
Resmethrin-2	3.3	86.1			
Silafluofen	3.7	88.6			



# Application News

## No.L497

### Supercritical Fluid Extraction / Chromatography

## Using the Nexera UC Online SFE-SFC-MS System to Analyze Residual Pesticides in Agricultural Products

The Nexera UC online SFE-SFC-MS system combines supercritical fluid extraction (SFE) and supercritical fluid chromatography (SFC) in one online system, so that the entire process from extraction of target components to acquisition of data can be performed completely automatically. Furthermore, the system can add polar organic solvents (modifiers) to the supercritical carbon dioxide fluid during SFE and SFC, so that the system can be used to extract and analyze components with a wide range of polarities.

Meanwhile, ever since the positive list system was enacted in 2006 in Japan for residual pesticides in foods, which applies to more than 800 types of pesticides, there has been increasing demand for a system able to simultaneously analyze multiple pesticides with a wide range of properties, including pretreating samples.

This article describes an example of using the Nexera UC online SFE-SFC-MS system to analyze residual pesticides in agricultural products.

### Online SFE-SFC-MS System

The operating principle of the Nexera UC online SFE-SFC-MS system is shown in Fig. 1. The extraction vessel filled with the sample is placed in the SFE unit and heated to an internal temperature of 40 °C (Fig. 1A). Then supercritical carbon dioxide fluid is pumped into the extraction vessel. After filling the vessel, the flow is stopped to allow static extraction of target components (Fig. 1B). After static extraction, the fluid is pumped through the extraction vessel for dynamic extraction (Fig. 1C). During dynamic extraction, extracted substances flow from the extraction vessel and into the analytical column. However, due to the high level of contaminant components in agricultural products, passing all the extract substances through the analytical column or mass spectrometer could damage the column or contaminate the mass spectrometer. Therefore, the Nexera UC online SFE-SFC-MS system splits the flow to send only a portion of the substances extracted from dynamic extraction through the analytical column. After dynamic extraction, fluid is only sent through the analytical flow line, where the analytical column is used for gradient separation and the mass spectrometer for detecting the target components (Fig. 1D).

### Sample Preparation

The QuEChERS is a well-known method that prioritizes simplicity and speed and is commonly used to pretreat agricultural products for residual pesticide analysis. However, the method involves many steps, such as adding reagents, solvent extraction, purification by dispersive solid phase extraction, and centrifugal separation. In contrast, the online SFE-SFC-MS system requires only mixing 1 g of agricultural product crushed with 1 g of a dehydrating agent\* and placing the mixture in the extraction vessel, as shown in Fig. 2. Consequently, the system improves analytical productivity, reduces the environmental impact, and also avoids human errors involved in the pretreatment steps. Using a dedicated rack changer, the system can continuously extract and analyze up to 48 samples at a time.

\* "Miyazaki Hydro-Protect" Patent No. 3645552

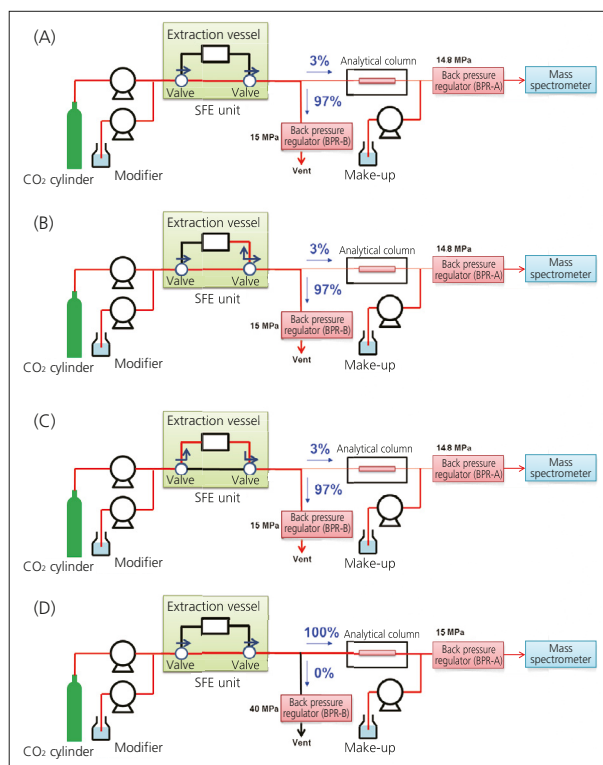

Fig. 1 Analysis Flow by Online SFE-SFC-MS

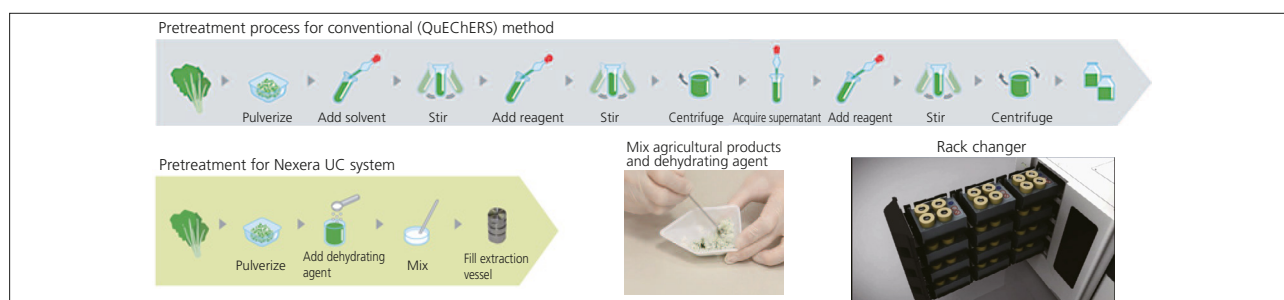

Fig. 2 Sample Preparation

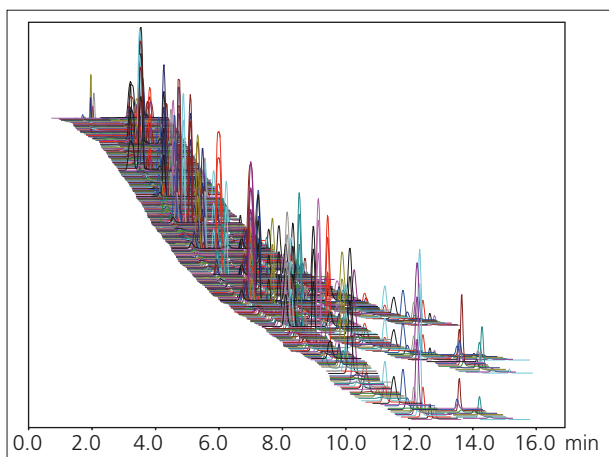

**Table 1 Analytical Conditions**

[SFE]	[SFC]
Solvent : A) Super critical fluid of CO <sub>2</sub> B) 0.1 % Ammonium formate in methanol	Column : Shim-pack UC-RP (250 mm L. × 4.6 mm I.D., 5 μm)
Flowrate : 5 mL/min	Mobile Phase : A) Super critical fluid of CO <sub>2</sub> B) 0.1 % Ammonium formate in methanol
Extraction : 0-3 min. Static mode (B.Conc. 5 %) 3-6 min. Dynamic mode (B.Conc. 5 %)	Time Program : B.Conc. 0 % (0 min.) → 10 % (11 min.) → 30 % (14 min.) → 40 % (14.01-17 min.)
Extraction Vessel Temp. : 40 °C	Flowrate : 3 mL/min
BPR Pressure : A) 14.8 MPa, B) 15 MPa (split rate: 3 %)	Make-up : 0.1 % Ammonium formate in methanol (0.1 mL/min.)
Make-up : 0.1 % Ammonium formate in methanol (0.4 mL/min.)	Column Temp. : 40 °C
	BPR Pressure : A) 15 MPa, B) 40 MPa
	Detector : LCMS-8050 MRM mode

**■ Analysis of Standard Mixture of Pesticides**

The standard mixture sample of 510 pesticide components were mixed with a dehydrating agent and analyzed using the analytical conditions indicated in Table 1. Fig. 3 shows the results. Using the system, we were able to accomplish the entire process, from extraction to data acquisition, in about 45 minutes per analysis. For 327 components, we obtained good repeatability for the concentration range from 1 to 100 ng/g (less than 30 %RSD for relative standard deviation for peak area at respective concentrations) and good linearity (contribution ratio of at least R<sup>2</sup> = 0.99). Table 2 also shows how pesticides with a wide range of polarities were analyzed with good repeatability and linearity.



**Fig. 3 Mass Chromatogram of Standard Pesticide Mixture Solution**

**Table 2 Repeatability and Linearity for Representative Pesticides**

Compounds	LogPow	Repeatability (%RSD, n=5)	Range (ng/g)	R <sup>2</sup>
Ethofenprox	6.9	6.1	1-100	0.9991
Hexaflumuron	5.68	6.8	1-100	0.9992
Benzofenap	4.69	1.4	2-200	0.9990
Mepronil	3.66	4.6	1-100	0.9993
Prometryn	3.34	2.7	1-100	0.9994
Fenamidone	2.8	3.0	2-200	0.9991
Ethylchlozate	2.5	3.0	1-100	0.9996
Imazosulfuron	1.6	6.2	1-100	0.9998
Bensulfuron methyl	0.79	8.1	1-100	0.9996
Primisulfuron methyl	0.2	5.5	1-100	0.9994
Halosulfuron methyl	-0.02	5.5	1-100	0.9996
Azimsulfuron	-1.4	4.2	1-100	0.9998

<Acknowledgments>

This Application News bulletin includes results obtained in cooperation with Osaka University, Kobe University, and the Miyazaki Agricultural Research Institute from the program for the "Development of Systems and Technology for Advanced Measurement and Analysis," sponsored by the Japan Science and Technology Agency (JST). We are deeply grateful to all those involved.

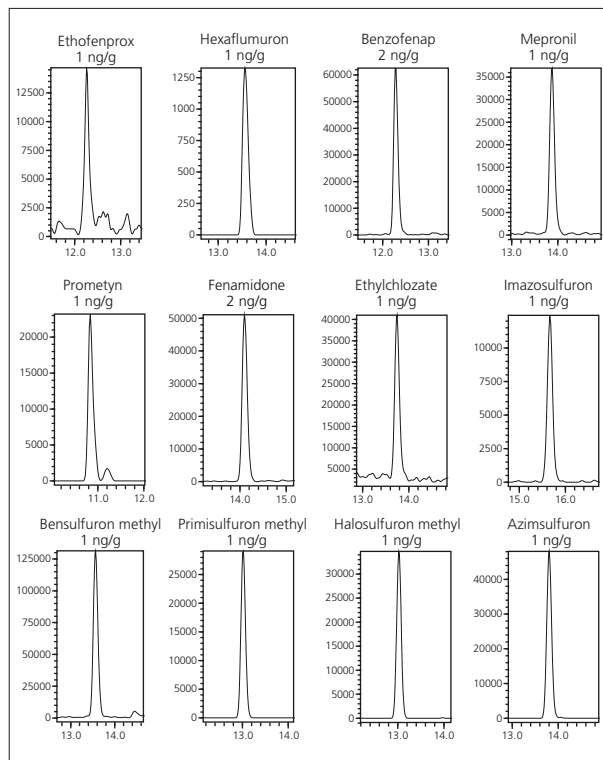

**Fig. 4 MRM Chromatograms of Representative Pesticides**

**■ Analysis of a Tomato**

Analysis of 10 ng/g of 510 pesticide components added to a tomato resulted in good repeatability (less than 20 %RSD for the relative standard deviation of the peak area) and a good recovery rate (70 to 120 %) for 248 components. Plots of LogPow and recovery rate results are shown in Fig. 5. It shows that pesticides with a wide range of polarities were analyzed with good recovery.

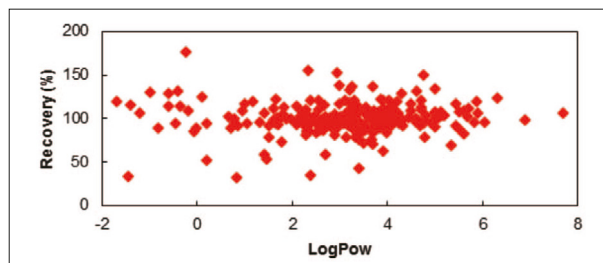

**Fig. 5 LogPow vs. Recovery Rate for Tomato Analysis**

# Application News

## No.L501

### Supercritical Fluid Extraction / Chromatography

## Analysis of Vitamin E in a Commercial Supplement by Offline SFE-SFC-PDA

Vitamin E, also called tocopherol, is a fat-soluble vitamin and an important chemical substance that exhibits an antioxidant effect, particularly in the human body. There are four tocopherols ( $\alpha$ ,  $\beta$ ,  $\gamma$  and  $\delta$ ) that differ based on the number and position of methyl groups. The  $\alpha$ -tocopherol exhibits the strongest antioxidant activity, and this is the tocopherol form found in most commercial supplements as vitamin E. Since it is highly fat-soluble, a quick and simple extraction method using supercritical fluid is expected to be applicable. In this article, we introduce a procedure for  $\alpha$ -tocopherol pretreatment that uses supercritical fluid extraction (SFE).

#### ■ Offline SFE System

While the online SFE-SFC system has already been described in several Application News articles, many have expressed the desire to combine SFE with existing analytical methods other than SFC, and SFE has gained attention for its flexibility in terms of sample handling. The advantages of SFE are as follows.

1. Quick and highly efficient extraction using supercritical fluid that is highly permeable and has a high diffusion rate.
2. Extraction of unstable compounds under mild temperature conditions with light-shielding.
3. Low cost compared to solvent extraction.
4. Complete automation of the extraction procedure.
5. Easy handling of the extraction sample.
6. Compatible with various analysis methods.

Fig. 1 shows a flow diagram for an offline SFE system. A supercritical state is present upstream of the BPR back-pressure control unit. Valves inside the SFE unit are controlled to switch between static extraction via enclosure of supercritical fluid in the vessel and dynamic extraction via passage of supercritical fluid through the vessel, which enables quick and highly efficient extraction of the target compounds.

A HPLC pump with a low-pressure GE valve installed is used in the solvent delivery system, and the extraction conditions can be optimized by changing the type of modifier (maximum of four types, including eluent from the trap column) and the concentration relative to carbon dioxide. Extract is retained in the trap column, and the low-pressure GE valve on the solvent delivery pump is switched to the solvent suitable for elution from the trap column. Then the eluent is collected in test tubes with a fraction collector.

#### ■ SFE Treatment for $\alpha$ -Tocopherol

The commercial supplement used as an actual sample may be present as a paste inside the capsule and may be moisture absorbent. As shown in Fig. 2, we mixed 275 mg of paste supplement with 1 g of Miyazaki Hydro-Protect, which is a dehydrating agent for SFE sold by Shimadzu, and transferred this mixture to the SFE extraction vessel.

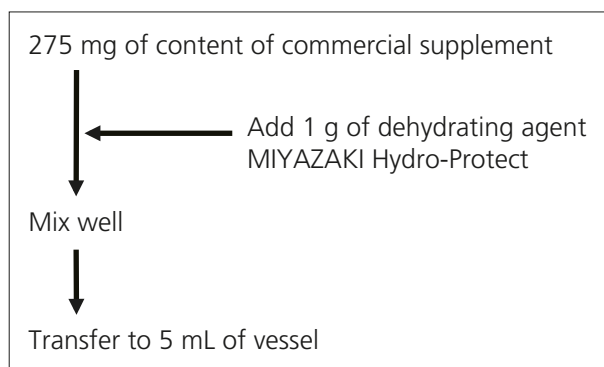

Fig. 2 Preliminary Pretreatment for Supplement Sample Before SFE

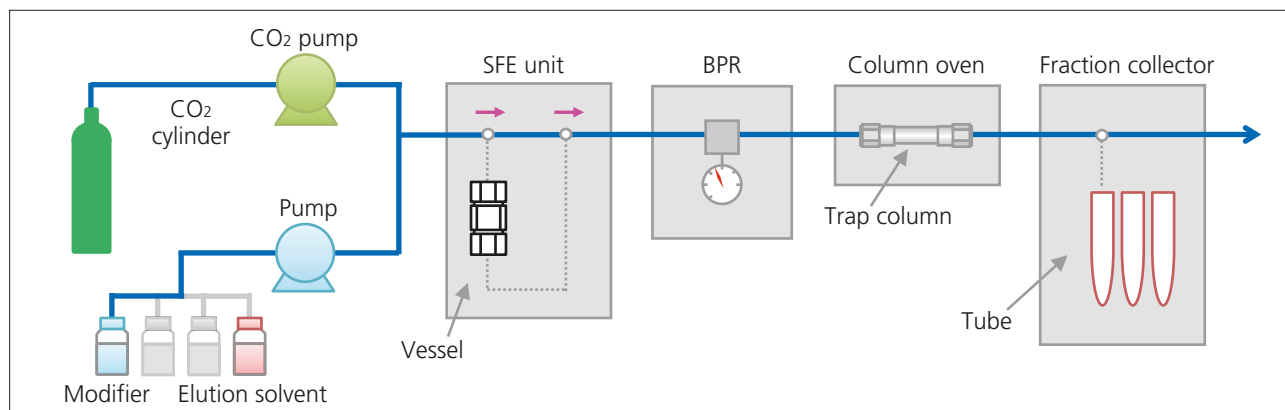

Fig. 1 Flow Diagram of Supercritical Fluid Extraction (SFE) System

The conditions used for SFE are shown in Table 1. We investigated column selection, chose the Shim-pack UCX-SIL analytical column, optimized each analytical condition for online SFE-SFC analysis, then performed analysis using the conditions shown in Table 2.

**Table 1 SFE Conditions for  $\alpha$ -Tocopherol**

Offline SFE:	
Extraction Vessel	: 5 mL
Extraction Solvent	: CO <sub>2</sub>
Flowrate	: 5 mL/min
Temperature	: 40 °C
Back Pressure	: 15 MPa
Extraction Time	: 15 min (Static 2 min → Dynamic 3 min) × 3 times
Trap & Pressure Down Conditions	
Trap Column	: Shim-pack VP-ODS (50 mm L. × 4.6 mm I.D.)
Temperature	: 60 °C
Pressure Down Time	: 10 min (15 - 25 min)
Recovery Conditions	
Elution Solvent	: Hexane
Flowrate	: 2 mL/min
Temperature	: 60 °C
Fraction Time	: 3.5 min (25 - 28.5 min)

### SFE Evaluation of $\alpha$ -Tocopherol in a Commercial Supplement

For the  $\alpha$ -tocopherol extract obtained through offline SFE, we performed SFC under the conditions shown in Table 2 then evaluated the extraction procedure. Extract was mixed with hexane to make up 10 mL before being used for SFC analysis. A representative SFC chromatogram is shown in Fig. 3.

**Table 2 SFC Conditions for  $\alpha$ -Tocopherol**

SFC Conditions:	
Column	: Nacalai COSMOSIL Cholester (250 mm L. × 4.6 mm I.D., 5 $\mu$ m)
Flowrate	: 3 mL/min
Modifier	: IPA
Gradient	: 2 % (0 min) - 20 % (10 min) - 50 % (10 - 12 min)
Temperature	: 40 °C
Back Pressure	: 15 MPa
Injection Volume	: 2 $\mu$ L

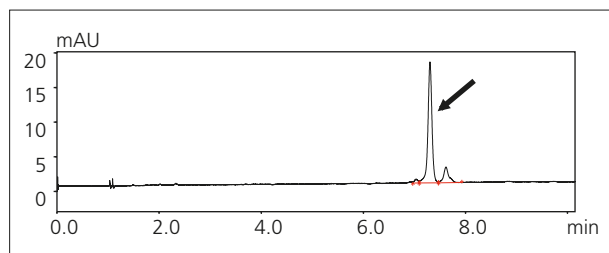

**Fig. 3 SFC Analysis of  $\alpha$ -Tocopherol Obtained by SFE from a Commercial Supplement**

First, we used a standard product to evaluate the suitability of the  $\alpha$ -tocopherol SFC conditions used for evaluation of offline SFE. Fig. 4 shows the linearity in the sample concentration range of 0.5  $\mu$ g/L to 2.0  $\mu$ g/L, and Table 3 shows the repeatability at a concentration of 1.0  $\mu$ g/L. Good linearity and sufficient repeatability in terms of retention time, peak area and peak height were obtained.

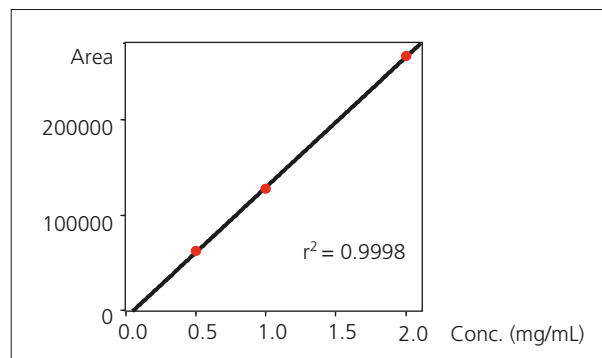

**Fig. 4 Linearity for Standard  $\alpha$ -Tocopherol Obtained by SFC**

**Table 3 Repeatability for Standard  $\alpha$ -Tocopherol Obtained by SFC (n=6)**

No	Retention Time (min)	Area	Height
Average	7.242	127,338	19,682
RSD (%)	0.057	0.573	0.274

Table 4 shows the repeatability of the quantitative  $\alpha$ -tocopherol result obtained by repeated SFE treatment, and  $\alpha$ -tocopherol recovery relative to the theoretical value (7.4 mg). Fig. 5 shows the overlaid chromatograms for  $\alpha$ -tocopherol. Good recovery and repeatability was confirmed after just one extraction, showing that offline SFE is effective for vitamin E compound extraction.

**Table 4 Repeatability and Recovery of  $\alpha$ -Tocopherol in a Commercial Supplement Using SFE**

No	Conc. (mg/mL)	Recovery (%)
1	0.776	104.46
2	0.780	105.00
3	0.772	103.92
4	0.790	106.35
5	0.761	102.44
6	0.758	102.04
Average	0.773	
RSD (%)	1.549	

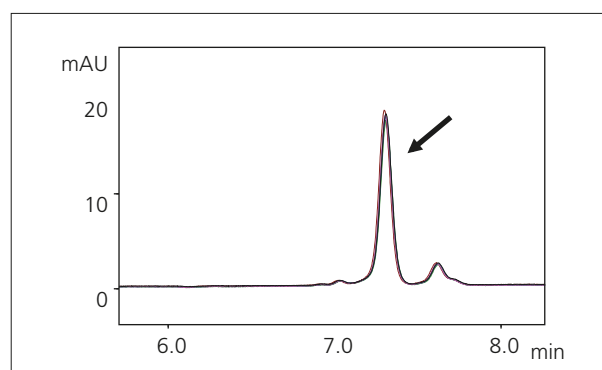

**Fig. 5 Overlaid Chromatograms for  $\alpha$ -Tocopherol After SFE**

# Application News

## No. L421

### High Performance Liquid Chromatography

## High Speed, High Resolution Analysis (Part 38) Analysis of Artificial Colorings with the Nexera UHPLC System

High-speed analysis of artificial colorings was previously introduced in Application News No. L349. In this issue, we present an example of ultra-high-speed analysis using the Nexera UHPLC (Ultra High Performance Liquid

Chromatography) System together with the Phenomenex Kinetex C18 high-speed, high-resolution analytical column, developed with the goal of achieving even greater analysis speeds.

### ■ Analysis of 12 Artificial Colorings

We conducted simultaneous analysis of 12 kinds of tar synthetic dyes. The Phenomenex Kinetex-C18 (particle size 2.6 μm) was used for the separation. This is a Core-Shell column consisting of a 1.9 μm solid core coated with a bonded multilayer (0.35 μm thick) of porous silica gel micro particles. Monitoring was conducted using the maximum absorbance (MAX plot) from 400 to 700 nm with the SPD-M20A photodiode array detector.

Fig. 1 shows the chromatogram of a standard mixture of the 12 artificial colorings (each at 50 mg/L in aqueous solution), in addition to a contour plot. Table 1 shows the analytical conditions.

The 12 dyes were separated within 1 minute using these analytical conditions. In addition, excellent repeatability of retention time and peak area were obtained for all of the components, using 6 consecutive injections (1-μL injections), as shown in Table 2.

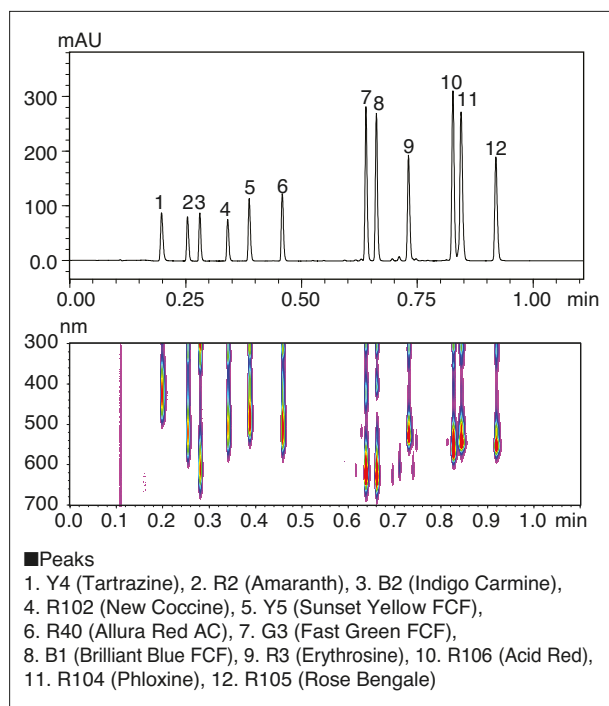

Fig. 1 Chromatogram and Contour Plot of a Standard Mixture of 12 Artificial Colorings (50 mg/L each)

Table 1 Analytical Conditions

Column	: Phenomenex Kinetex 2.6 μm C18 100 Å (50 mm L. × 3.0 mm I.D., 2.6 μm)
Mobile Phase	: A; 10 mmol/L Ammonium acetate B; 10 mmol/L Ammonium acetate/Acetonitrile = 1/1 (v/v)
Flowrate	: 2.5 mL/min
Time Program	: B Conc. 5 % (0.0 min) → 100 % (1.1-1.6 min) → 5 % (1.61-2.4 min) • Mixer: 20 μL
Column Temp.	: 40 °C
Injection Volume	: 1 μL
Detection	: SPD-M20A Max Plot 400-700 nm
Flow Cell	: Semi-micro cell

Table 2 Repeatability of 12 Artificial Colorings (n=6)

Peak No.	Retention Time %RSD	Peak Area %RSD
1	0.103	0.117
2	0.069	0.161
3	0.047	0.289
4	0.068	0.219
5	0.091	0.116
6	0.057	0.203
7	0.066	0.170
8	0.056	0.206
9	0.021	0.073
10	0.034	0.117
11	0.032	0.140
12	0.037	0.148

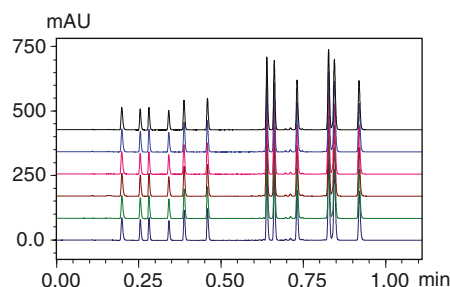

### ■ Analysis of Artificial Colorings in Food

Pickle juice and liquid extract of candy were measured using the analytical conditions shown in Table 1. The

retention times and spectral patterns of the detected peaks matched those of the standard substances.

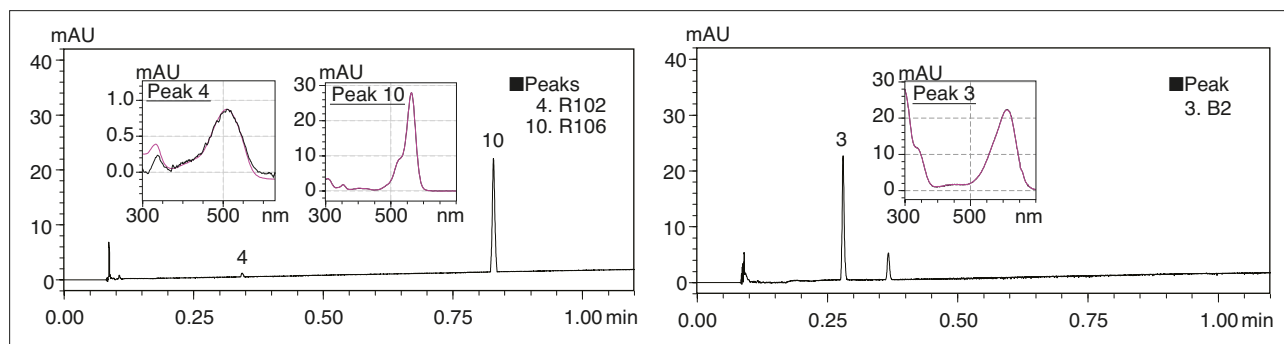

Fig. 2 Chromatograms and Spectra of Artificial Colorings in Food (Left: Pickle, Right: Candy)

### ■ Analysis of 21 Artificial Colorings

We conducted analysis of 21 artificial substances, consisting of those listed on the previous page together with 9 additional dye substances. Based on investigation of the gradient analysis conditions (Table 3), simultaneous analysis was completed within 2 minutes.

Fig. 3 shows the MAX plot and the chromatograms obtained using 3 different wavelengths.

Chromatographic peaks were identified for yellow dyes at 450 nm, red dyes at 520 nm, and blue-green dyes at 620 nm. Thus, simultaneous quantitation can be achieved by selecting the appropriate detection wavelength for each substance using the photodiode array detector. In the MAX plot, peak 20 (Orange II) and peak 21 (Patent Blue V) are overlapping, however, as shown in Fig. 4, at 450 nm and 620 nm, almost none of the other substances are present, allowing quantitation at each separate wavelength.

Table 3 Analytical Conditions

Time Program	: B Conc. 5 % (0.0 min) → 100 % (2.5-2.7 min) → 5 % (2.71-3.5 min)
Detection	: SPD-M20A Max Plot 400-700 nm, 450 nm, 520 nm, 620 nm

\*The other conditions are the same as specified in Table 1.

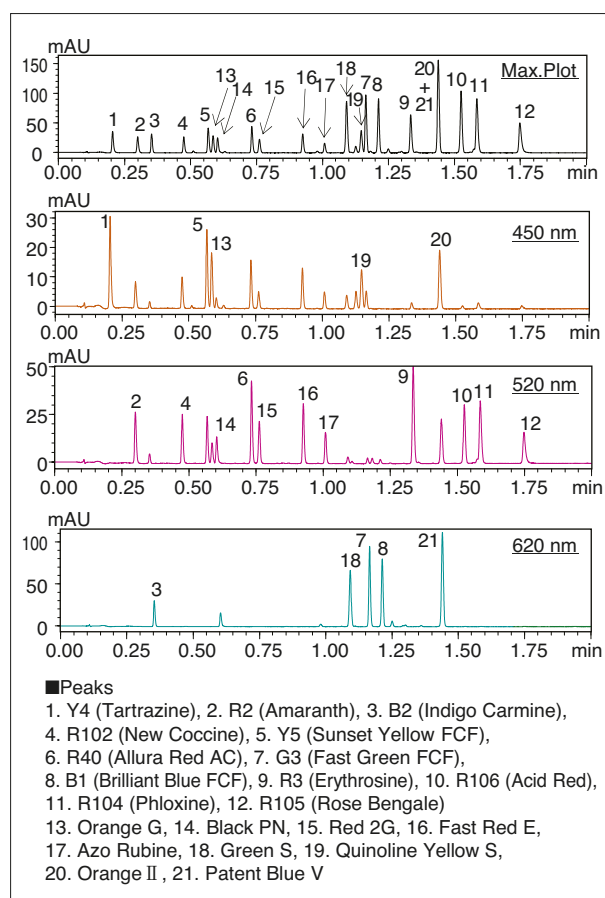

Fig. 3 Multi-Chromatogram of a Standard Mixture of 21 Artificial Colorings (25 mg/L each)

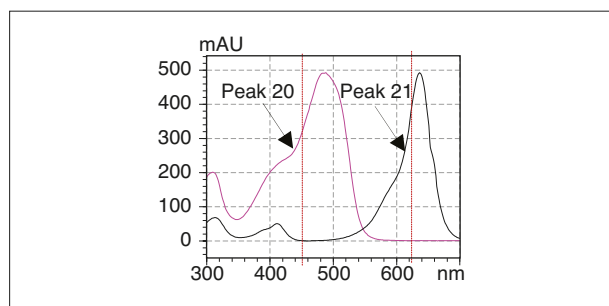

Fig. 4 Spectra of Peak 20 and Peak 21

First Edition: Sep. 2011



For Research Use Only. Not for use in diagnostic procedure.

This publication may contain references to products that are not available in your country. Please contact us to check the availability of these products in your country.

The content of this publication shall not be reproduced, altered or sold for any commercial purpose without the written approval of Shimadzu. Company names, product/service names and logos used in this publication are trademarks and trade names of Shimadzu Corporation or its affiliates, whether or not they are used with trademark symbol "TM" or "®". Third-party trademarks and trade names may be used in this publication to refer to either the entities or their products/services. Shimadzu disclaims any proprietary interest in trademarks and trade names other than its own.

The information contained herein is provided to you "as is" without warranty of any kind including without limitation warranties as to its accuracy or completeness. Shimadzu does not assume any responsibility or liability for any damage, whether direct or indirect, relating to the use of this publication. This publication is based upon the information available to Shimadzu on or before the date of publication, and subject to change without notice.



## UHPLC assay for stevia glycosides

Gesa J. Schad, Shimadzu Europa GmbH

### Introduction

With today's growing health awareness, there is an increasing interest in sugar substitutes in various areas of the food industry. Stevia, the natural alternative to artificial sweeteners, extracted from the *Stevia rebaudiana* plant has just recently been approved for use in the EU. Rebaudioside A is largely enriched in commercial Stevia products, while natural extract contains Stevioside as the major component. Hence, an HPLC assay for quality control purposes, must be able to clearly separate this critical peak pair.

### Analytical conditions

#### System configuration:

A Shimadzu Nexera X2 UHPLC system was used consisting of two quaternary solvent pumps (LC-30AD) with two 5 channel degassers (DGU-20A5R), an autosampler (SIL-30AC), and a column oven (CTO-20AC). The system was also equipped with an SPD-M30A photo diode array detector.

#### Method:

Column: ACE Excel 2 Super C18, 150 x 2.1 mm  
Mobile Phase: 10 mM NaH<sub>2</sub>PO<sub>4</sub>, pH 2.8

A: in H<sub>2</sub>O and B: in MeCN/H<sub>2</sub>O  
(80:20 v/v)

Gradient: 39.5 – 48 % B: in 4 min

Cycle time: 7 min Flow rate: 0.6 mL/min

Temperature: 50 °C Injection Volume: 1 µL

Sample: 0.04 mg/mL of each compound in MeCN/H<sub>2</sub>O (6:94)

### Chromatogram

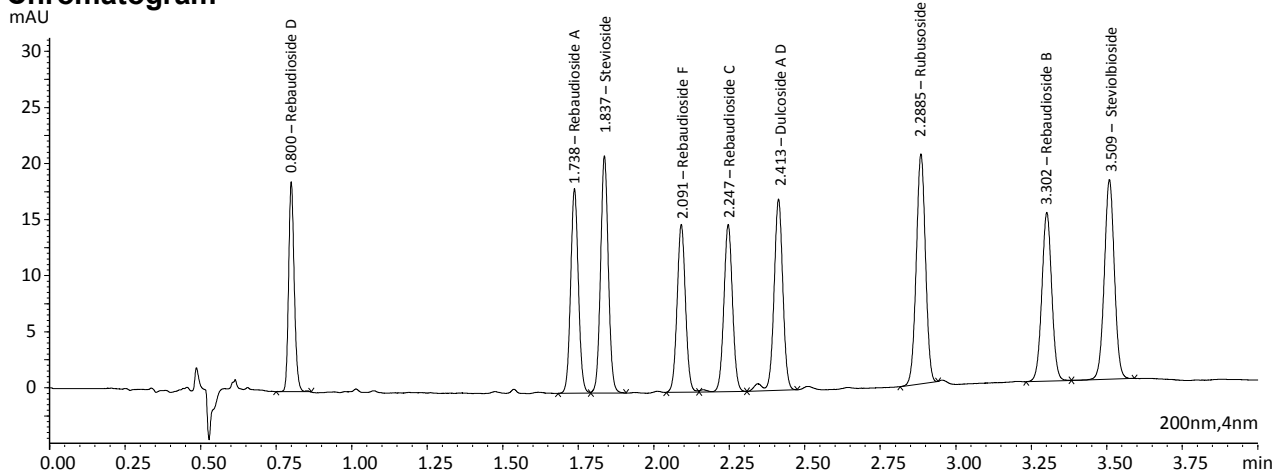

### Conclusion / Result

A robust, selective, and sensitive separation of nine stevia glycosides in less than a third of the

time of the JECFA approved assay was established successfully within two working days.

# Application Data Sheet

# 35

**LC**  
Liquid Chromatograph

## High-Speed Analysis of Amino Acids and Histamine in Fish Sauce via Automated OPA Pre-column Derivatization

Processed foods and fish containing a significant amount of histamine have resulted in several cases of allergic food poisoning. In Japan, no standard values have been set for histamine concentrations in foods. However, the FDA has specified levels of 50 mg/kg max. for foods in general, the EU has specified 100 mg/kg max. for marine products, and the Codex Alimentarius standard specifies 400 mg/kg max. for fish sauce.

### Simultaneous Analysis of Amino Acids and Histamine in Fish Sauce

Amino acids and histamine were derivatized via o-phthalaldehyde (OPA) and chloroformic acid 9-fluorenylmethyl (FMOC) using the automatic pretreatment function of the Nexera X2 Ultra High Performance Liquid Chromatograph (UHPLC) system's SIL-30AC autosampler. A simultaneous analysis of primary amines (OPA derivatives) and secondary amines (FMOC derivatives), which differ in detection wavelength, was enabled by the wavelength switching function of the RF-20Axs fluorescence detector.

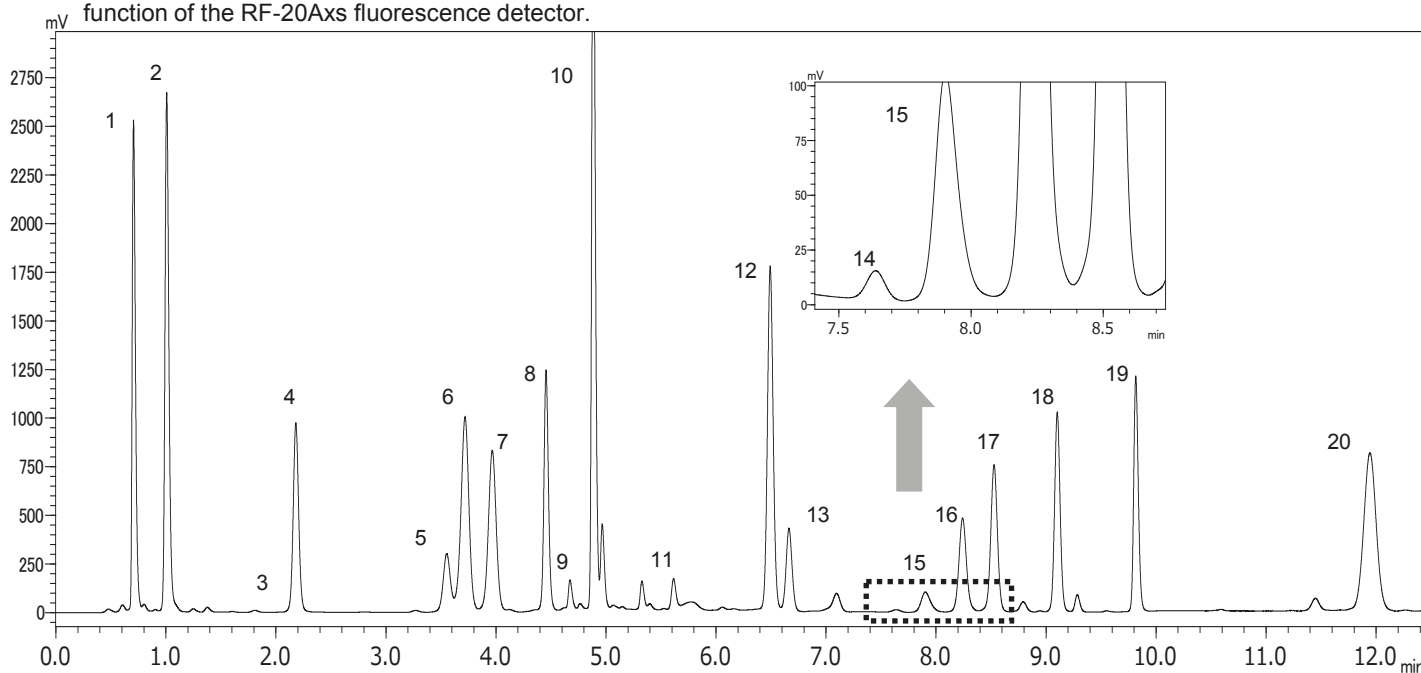

#### Pretreatment Procedure

1. Mix a 0.5 mol/L aqueous trichloroacetic acid solution with the sample in a 2:1 ratio (v/v ratio), and then centrifuge the mixture (10,000 rpm for 5 minutes).
2. Mix a 0.3 mol/L aqueous sodium hydroxide solution with the supernatant in a 1:3 ratio (v/v ratio).
3. Dilute the mixture 100 fold with a 0.1 mol/L boric acid buffer solution and then filter it through a 0.2 μm rated membrane filter before proceeding with the analysis.

Column: YMC Triart C18 1.9 μm  
(75 mmL. × 3.0 mmI.D., 1.9 μm)  
Mobile phase: A) 20 mmol/L (Potassium) Phosphate buffer (pH 6.5)  
B) Acetonitrile/Methanol/Water = 45/40/15 (v/v/v)  
Gradient Elution  
Flow rate: 0.8 mL/min  
Column temp.: 35 °C  
Injection volume: 1 μL

Peaks:  
1. Aspartic Acid 7. Threonine 14. Histamine  
2. Glutamic Acid 8. Citrulline 15. Tryptophan  
3. Asparagine 9. Arginine 16. Phenylalanine  
4. Serine 10. Alanine 17. Isoleucine  
5. Histidine 11. Tyrosine 18. Leucine  
6. Glycine 12. Valine 19. Lysine  
13. Methionine 20. Proline

First Edition: May, 2013

# Application News

## No. L430

### High Performance Liquid Chromatography

## High Speed, High Resolution Analysis (Part 40) Analysis of Aflatoxins in Food by Nexera UHPLC with an Immunoaffinity Column for Sample Preparation

Aflatoxins are mycotoxins that are extremely carcinogenic and acutely toxic, and are therefore subject to stringent monitoring in food products. In the past, aflatoxin control in Japan applied specifically to aflatoxin B<sub>1</sub>, but from October, 2011, total aflatoxins (total of aflatoxins B<sub>1</sub>, B<sub>2</sub>, G<sub>1</sub> and G<sub>2</sub>) became subject to this restriction<sup>1)</sup>.

The official notification of this regulation change specifies the use of a multifunctional column or an immunoaffinity column for isolation and cleanup of the aflatoxins<sup>2)</sup>. Of the two, it is believed that an immunoaffinity column would be more effective for samples like spices and processed foods, which contain many impurity substances.

In Application News No. L422, we introduced an example of aflatoxins analysis which offered improved analysis efficiency, in which we conducted ultra-high-speed analysis of the 4 aflatoxins using a combination of the Prominence RF-20Axs high-sensitivity fluorescence detector and the Nexera Ultra High Performance LC system using direct high-sensitivity fluorescence detection without derivatization of the aflatoxins.

Here we introduce an example of high-speed analysis using direct fluorescence detection in which the aflatoxins in processed food and spice were cleaned up using an immunoaffinity column.

### ■ Analysis of Food Products – Sample Preparation Using Immunoaffinity Column

Roasted peanuts (processed) and nutmeg (spice)<sup>\*1</sup> were subjected to sample preparation according to the procedures in Fig. 2 and Fig. 3 on the following page<sup>\*2</sup>. For the immunoaffinity column, the AFLAKING (Horiba, Ltd.)<sup>\*3</sup> was used. Standard solution was added to each sample to adjust the concentrations of aflatoxins B<sub>1</sub> and G<sub>1</sub> to 0.8 µg/kg, and B<sub>2</sub> and G<sub>2</sub> to 0.2 µg/kg.

Fig. 1 shows the results of analysis of the roasted peanuts and nutmeg, and Table 1 shows the analytical conditions. Use of this analysis method permits the analysis time to be shortened to one-fourth that of the conventional conditions (Application News No. L428). Furthermore, since almost no substances were detected aside from the aflatoxins due to sample cleanup using the immunoaffinity column, even faster analysis can be expected by further shortening the column.

Using this analytical method, direct, high-sensitivity detection of aflatoxins B<sub>1</sub> and G<sub>1</sub> is conducted without derivatization (conversion to hydroxide) using trifluoroacetic acid (TFA). For comparison, the analysis results obtained following TFA pretreatment are shown in Fig. 4 on the following page.

\*1: The roasted peanuts and nutmeg samples were provided by the Mycotoxin Research Association.

\*2: Part of the experimental method differs from the official method.

\*3: AFLAKING can be obtained from Shimadzu GLC, Ltd.

**Table 1 Analytical Conditions**

Column	: Shim-pack XR-ODS II (100 mm L. × 3.0 mm I.D., 2.2 µm)
Mobile Phase	: Water / Methanol / Acetonitrile = 6/3/1 (v/v/v)
Flow Rate	: 1.0 mL/min
Column Temp.	: 50 °C
Injection Volume	: 8 µL
Detection	: RF-20Axs Ex. at 365 nm, Em. at 450 nm
RF Cell	: Conventional cell
Cell Temp.	: 25 °C

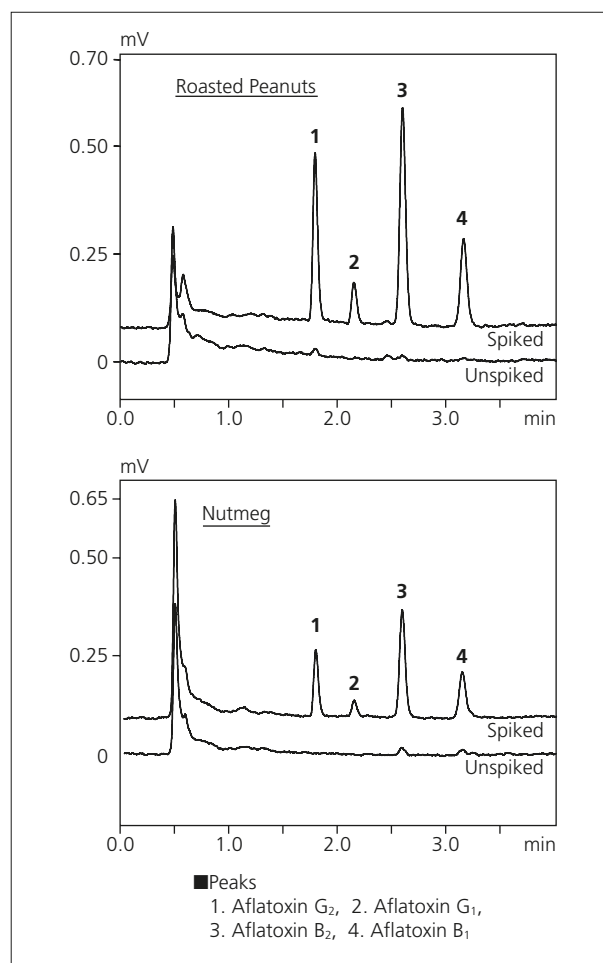

**Fig. 1 Chromatograms of Roasted Peanuts and Nutmeg (Upper) Spiked, (Lower) Unspiked**

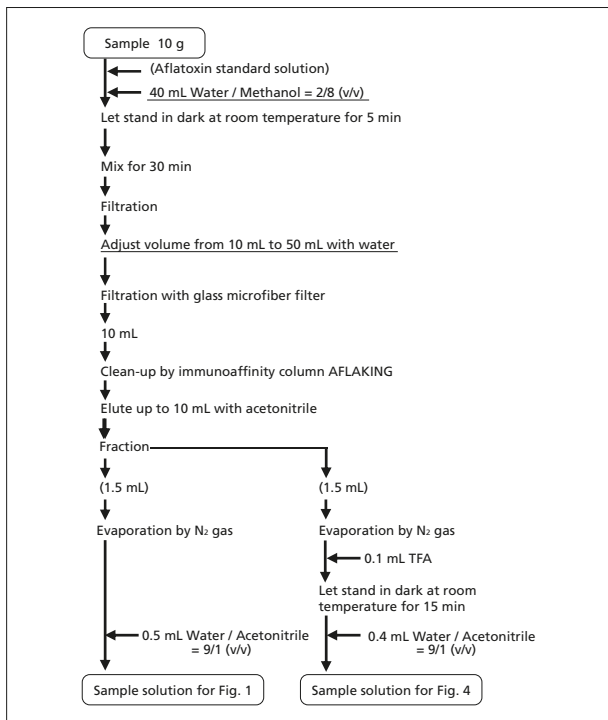

Fig. 2 Sample Preparation for Roasted Peanuts

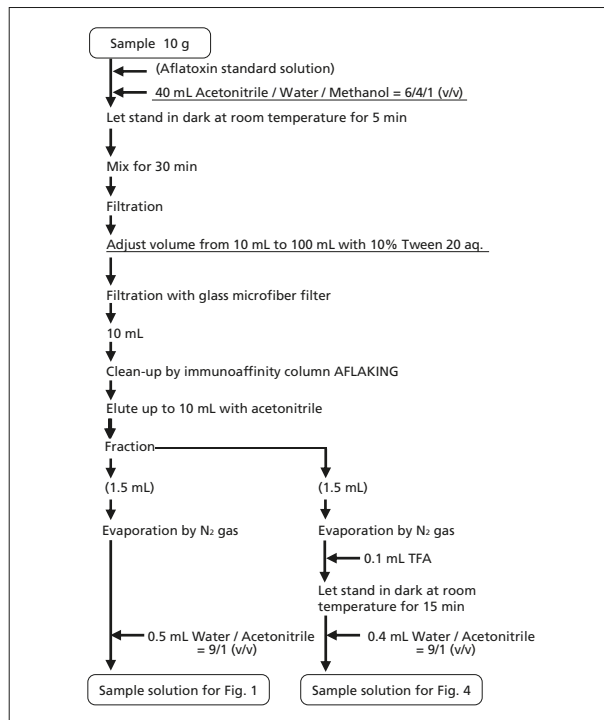

Fig. 3 Sample Preparation for Nutmeg

### ■ Analysis of Food Sample after Derivatization with Trifluoroacetic Acid

Fig. 4 shows the results of analysis of food samples subjected to derivatization using TFA, and Table 2 shows the analytical conditions used. Each sample shown in Fig. 2 and Fig. 3 was subjected to derivatization using TFA following pretreatment with an immunaffinity column.

Table 2 Analytical Conditions

Column	: Shim-pack XR-ODS II 100 mm L. x 3.0 mm I.D., 2.2 μm
Mobile Phase	: Water / Methanol / Acetonitrile = 6/3/1 (v/v/v)
Flow Rate	: 0.9 mL/min
Column Temp.	: 40 °C
Injection Volume	: 8 μL
Detection	: RF-20Axs Ex. at 365 nm, Em. at 450 nm
RF Cell	: Conventional cell
Cell Temp.	: 25 °C

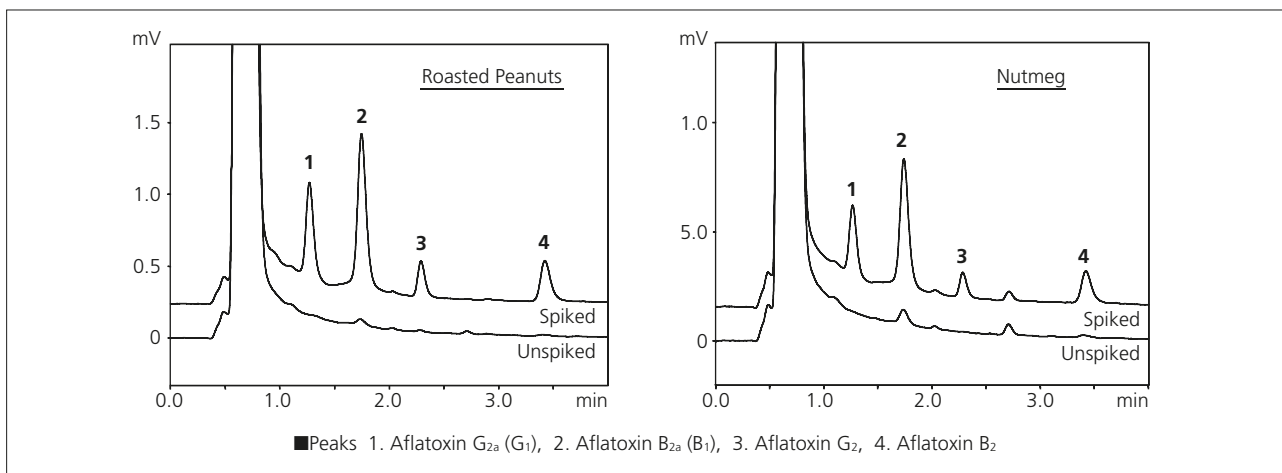

Fig. 4 Chromatograms of Roasted Peanuts and Nutmeg Obtained After Derivatization with TFA; (Upper) Spiked, (Lower) Unspiked

#### [References]

- 1) Handling of Foods Containing Aflatoxins (Notification 0331, No. 5, issued on March 31, 2011 by the Food Safety Division, Ministry of Health, Labour and Welfare)
- 2) Test Method for Total Aflatoxins (Notification 0816, No. 1, issued on August 16, 2011 by the Food Safety Division, Ministry of Health, Labour and Welfare)

# Application News

## No. L432

### High Performance Liquid Chromatography

## High Speed, High Resolution Analysis (Part 44) Analysis of Pre-Column Derivatized Amino Acids by SIL-30AC Autosampler

Amino acid analysis is required in a wide range of fields, including foods and pharmaceuticals, and various methods of derivatization have been devised to improve sensitivity and selectivity when conducting amino acid analysis by HPLC. Previously, amino acid analysis by post-column derivatization using OPA was introduced in

Application News articles No. L292 and L299A.

Here, using the RF-20Axs fluorescence detector and the SIL-30AC autosampler with its automated pretreatment functions, we introduce the analysis of amino acids using pre-column derivatization with OPA and FMOC.

### ■ Simultaneous Determination of 22 Amino Acids

Using the automated pretreatment functions of the Nexera SIL-30AC autosampler, primary and secondary amino acids were automatically derivatized into fluorescent substances within the autosampler using o-phthalaldehyde (hereafter, OPA) and 9-fluorenyl methyl chloro formate (hereafter, FMOC), respectively. After separation of the derivatized amino acids using the ultra-high speed YMC-Triart C18 column (1.9  $\mu\text{m}$ , YMC Co., Ltd.), high-sensitivity detection was conducted using the RF-20Axs fluorescence detector. Since the OPA-derivatized amino acids and FMOC-derivatized amino acids are detected at different

wavelengths, simultaneous analysis was conducted utilizing the automatic wavelength switching feature.

Table 1 shows the derivatization reagents used in this method, and Fig. 1 shows the reagent addition and mixing steps used to conduct the automated derivatization using the SIL-30AC autosampler. Since a constant reaction time can be maintained with the automated derivatization using the autosampler, excellent repeatability can be obtained compared with pre-column derivatization by manual operation.

Table 2 shows the analytical conditions, and Fig. 2 shows the chromatogram.

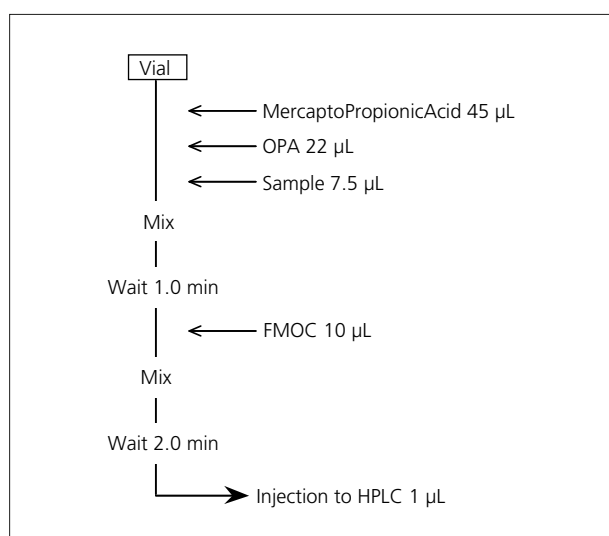

Fig. 1 Flowchart of Automated Pre-Column Derivatization with SIL-30AC

Table 1 Derivatization Reagents

● Mercaptopropionic Acid	3-Mercaptopropionic Acid 10 $\mu\text{L}$ in 0.1 mol/L Borate Buffer (pH 9.2) 10 mL
● o-Phthalaldehyde Solution	o-Phthalaldehyde 10 mg in 0.1 mol/L Borate Buffer (pH 9.2) 5 mL
● Fluorenyl Methyl Chloro Formate - Acetonitrile Solution	9-Fluorenyl Methyl Chloro Formate 4 mg in Acetonitrile 20 mL

Table 2 Analytical Conditions

Column	: YMC-Triart C18, 1.9 $\mu\text{m}$ (75 mmL. $\times$ 3.0 mmI.D., 1.9 $\mu\text{m}$ , YMC Co., Ltd.)
Mobile Phase	: A : 20 mmol/L Phosphate Potassium Buffer (pH 6.9) B : 45/40/15 Acetonitrile/Methanol/Water
Time Program	: B Conc. 11 % $\rightarrow$ 13 % (0.00-3.00 min) $\rightarrow$ 31 % (5.00 min) $\rightarrow$ 37 % (7.5 min) $\rightarrow$ 70 % (10.00 min) $\rightarrow$ 100 % (10.50-13.50 min) $\rightarrow$ 11 % (14.00 min)
Flow Rate	: 0.8 mL/min
Column Temp.	: 35 $^{\circ}\text{C}$
Injection Volume	: 1 $\mu\text{L}$
Detection	: RF-20Axs Ex. at 350 nm, Em. at 450 nm $\rightarrow$ Ex. at 266 nm, Em. at 305 nm (9.0 min)
Cell Temp.	: 20 $^{\circ}\text{C}$
Flow Cell	: Conventional cell



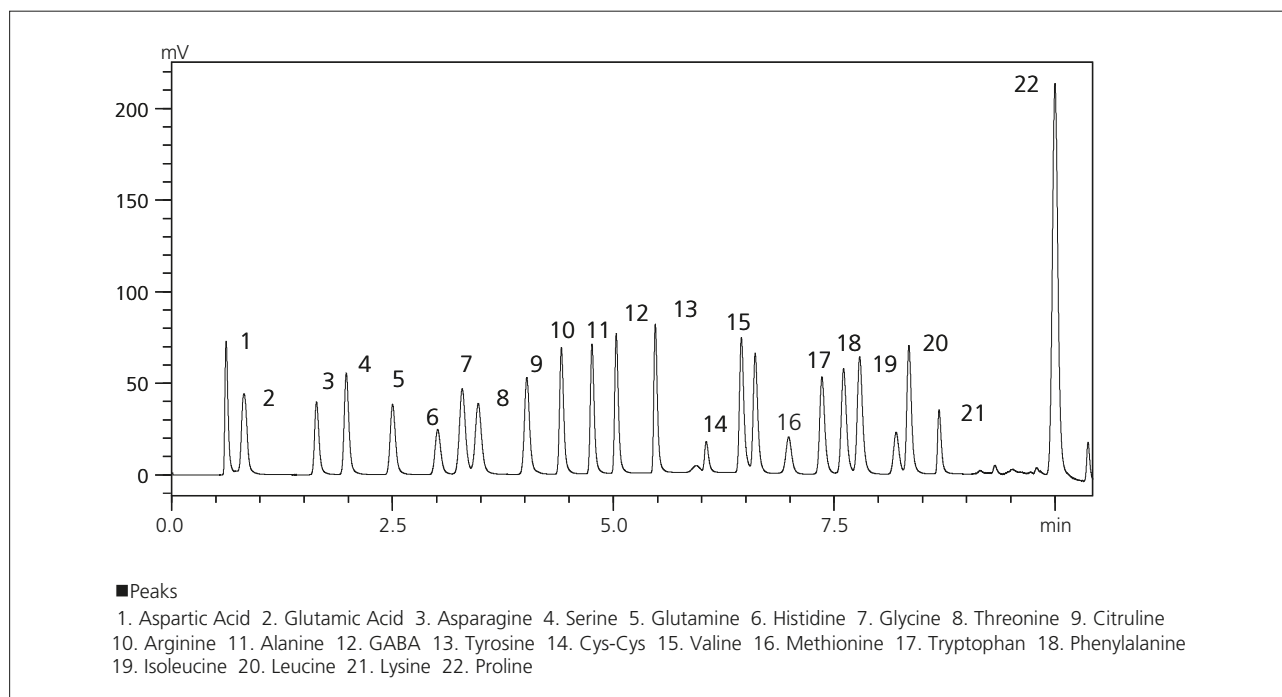

Fig. 2 Chromatogram of 22 Amino Acids (10 μmol/L Each, 1 μL Injection)

■ Linearity and Repeatability

Using calibration curves generated with a concentration range from 1-100 μmol/L for each amino acid, excellent linearity was obtained, with a ratio of contribution ( $R^2$  value) greater than 0.999 in all cases. Table 3 shows the peak area repeatability for all 22 amino acids obtained in repeat analysis (n = 6).

Table 3 Repeatability

	Area%RSD		Area%RSD
Asp	0.50	GABA	0.41
Glu	0.48	Tyr	0.55
Asn	0.51	Cys-Cys	0.46
Ser	0.41	Val	0.71
Gln	0.56	Met	0.71
His	0.57	Trp	0.70
Gly	0.29	Phe	0.73
Thr	0.55	Ile	0.63
Citruline	0.46	Leu	0.55
Arg	0.45	Lys	0.56
Ala	0.46	Pro	2.35

■ Analysis of Actual Samples

Fig. 3 shows a chromatogram of analysis of a commercially available soft drink using this method. The sample was analyzed after filtering it through a 0.2 μm membrane filter.

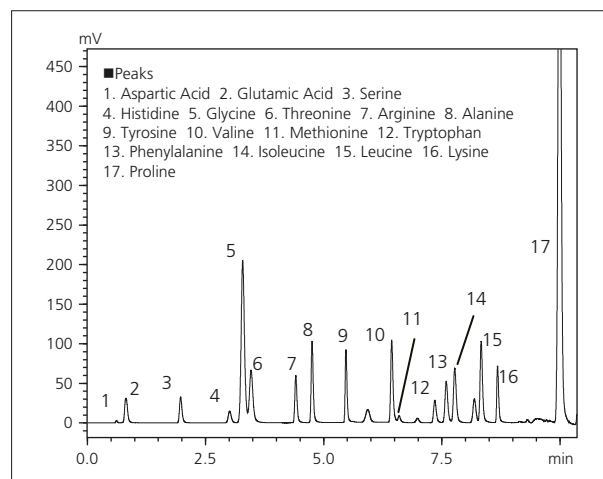

Fig. 3 Chromatogram of Soft Drink

# Application News

## No. L449

### High Performance Liquid Chromatography

## High Speed, High Resolution Analysis (Part 46) Analysis of Pre-Column Derivatized Biogenic Amines by the Nexera SIL-30AC Autosampler

Biogenic amines are produced naturally by the enzymatic decarboxylation of amino acids in beverages and food. Biogenic amines such as these are also used as an indicator of food spoilage. Histamine, a substance that can cause allergy-like food poisoning, must not exceed 50 ppm in food in general according to FDA standards, 100 ppm in marine products in the EU, and 400 ppm in fish sauce according to the Codex International Food Standards. In addition, biogenic amines such as cadaverine and tyramine appear to intensify the allergy-like food toxicity of histamine. In Application News articles L432 and L437, we introduced examples of the pretreatment functions of the SIL-30AC autosampler in the analysis of fluorescence-derivatized amino acids using o-phthalaldehyde (OPA). Here, we introduce an example of the analysis of fluorescent amines that were derivatized with OPA.

### ■ Simultaneous Determination of 7 Biogenic Amines

With this method, the pretreatment functions of the Nexera SIL-30AC autosampler were utilized to conduct automated derivatization of the amines using OPA. Table 1 shows the derivatization reagents used with this method, and Fig. 1 shows the reagent addition and mixing settings that were used for automated derivatization using the Nexera SIL-30AC autosampler. The analytical conditions that were used are shown in Table 2, and the chromatogram obtained from analysis of a standard solution is shown in Fig. 2. In addition to automating the derivatization step, the overall analysis time can be further shortened by using the overlapping injection feature that was introduced in Application News L437. This allows the next sample in the sequence to be derivatized and loaded into the needle for injection immediately after the analysis of the current sample is complete.

**Table 1 Derivatization Reagents (10 mg/L each)**

- Mercaptopropionic Acid Solution (MPA solution)  
3-Mercaptopropionic Acid 10 µL in 0.1 mol/L Borate Buffer (pH 9.2) 10 mL
- o - Phthalaldehyde Solution (OPA solution)  
o - Phthalaldehyde 10 mg in 0.1 mol/L Borate Buffer (pH 9.2) 10 mL

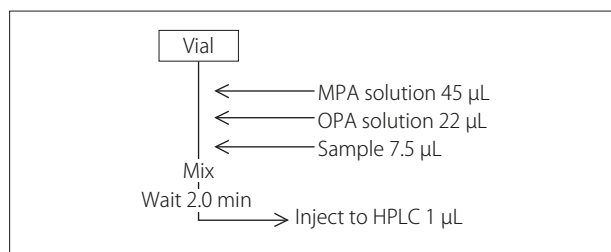

**Fig. 1 Flowchart of Derivatization with SIL-30AC**

**Table 2 Analytical Conditions**

Column	: Shim-pack XR-ODSⅢ (75 mm L. × 2.0 mm I.D., 1.6 µm)
Mobile Phase	: A: 100 mmol/L Acetate (Sodium) Buffer (pH 4.7) B: Acetonitrile
Time Program	: B.Conc. 15 % (0 min) →30 % (3 min) →40 % (8 min) →15 % (8.01-11 min)
Flowrate	: 0.5 mL/min
Column Temp.	: 40 °C
Injection Vol.	: 1 µL
Detection	: RF-20Axs Ex. at 330 nm, Em. at 440 nm
Cell Temp.	: 30 °C
Flow Cell	: Semi-micro cell

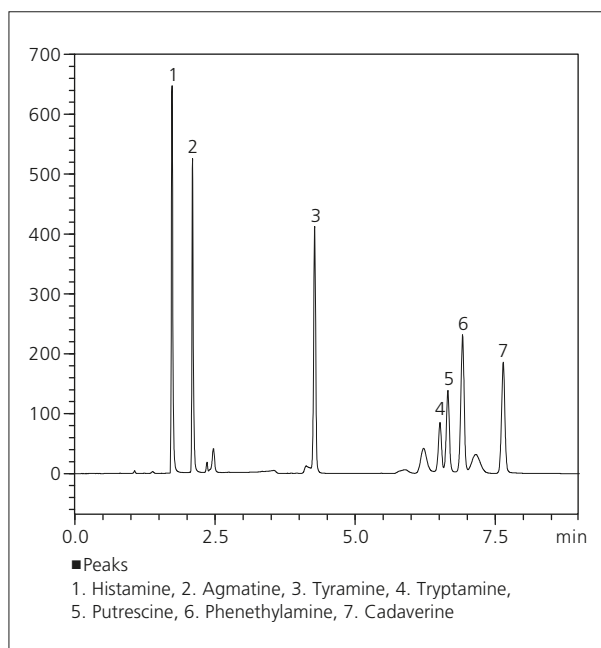

**Fig. 2 Chromatogram of Standard Solution of 7 Biogenic Amines (10 mg/L each)**

### Linearity and Repeatability

The calibration curves generated using amine concentrations from 0.1 to 100 mg/L showed excellent linearity with a coefficient of determination ( $R^2$ ) greater than 0.999 for all components. Table 3 shows the repeatability of retention times and area values obtained from repeated injections of 7 amines (n=6).

Table 3 Repeatability

	R.T. %RSD	Area %RSD
Histamine	0.067	0.70
Agmatine	0.055	0.72
Tyramine	0.037	0.60
Tryptamine	0.035	0.88
Putrescine	0.037	0.61
Phenethylamine	0.036	0.37
Cadaverine	0.030	0.84

### Analysis of Foods and Beverages

Figs. 3 to 6 show the results of analysis of commercially available beer, wine, pork, and tuna samples. The beer and wine were passed through a 0.22  $\mu$ m membrane filter, and then used as sample solutions. The pork and tuna were first stored at 37 °C for 24 hours to accelerate the production of amines. Then, 0.5 mol/L aqueous trichloroacetic acid solution was added to the homogenized samples, and following centrifugation, the supernatants were neutralized with 0.3 mol/L aqueous sodium hydroxide solution, and then passed through a 0.22  $\mu$ m membrane filter to serve as sample solutions.

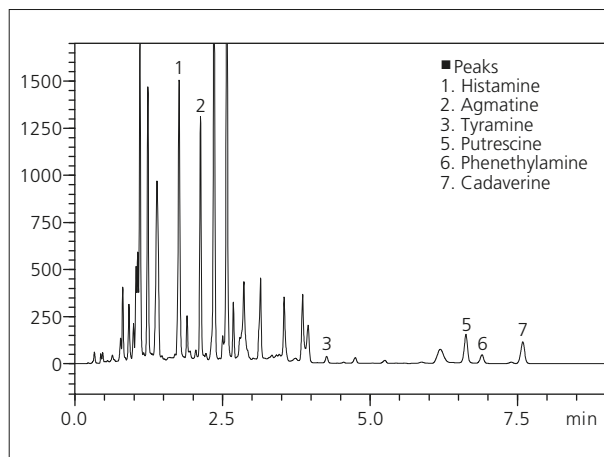

Fig. 4 Chromatogram of Wine

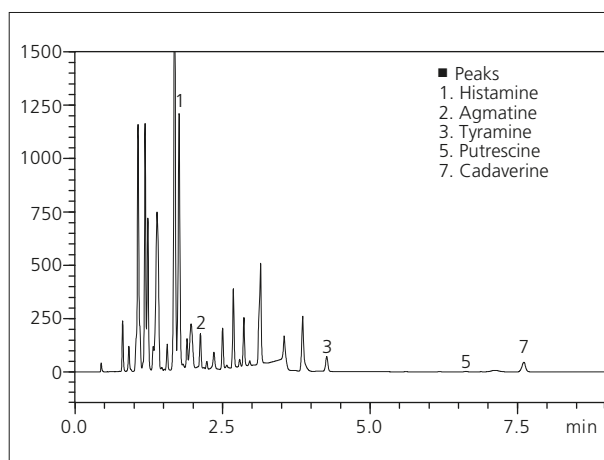

Fig. 5 Chromatogram of Pork

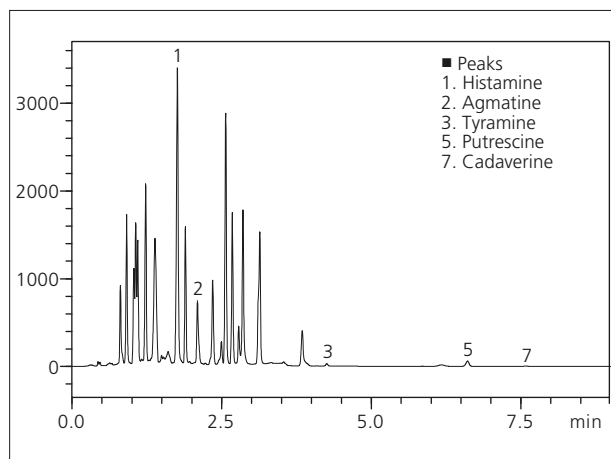

Fig. 3 Chromatogram of Beer

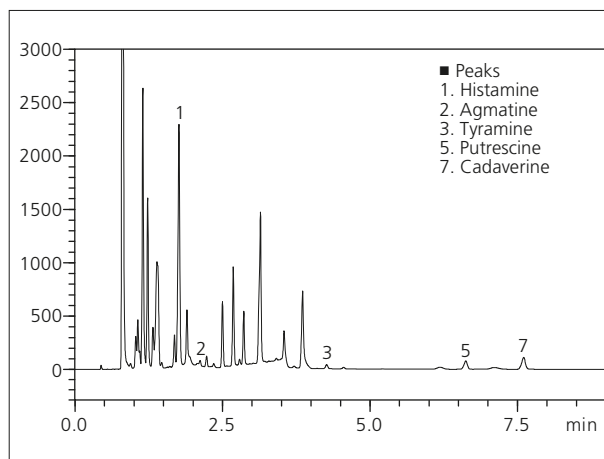

Fig. 6 Chromatogram of Tuna

## Technical Report

# Comprehensive Two-dimensional Liquid Chromatography for Determination of Polyphenols in Red Wines

LC×LC-PDA-MS/MS for polyphenol analysis in red wine

Paola Dugo<sup>1,2</sup>, Francesca Rigano<sup>1</sup>, Francesco Cacciola<sup>1</sup>, Paola Donato<sup>1</sup>, Luigi Mondello<sup>1,2</sup>

### Abstract:

A comprehensive two-dimensional liquid chromatography method was developed and applied to the determination of polyphenols in red wines. To fulfil such a task, a micro cyano and a partially porous octadecylsilane columns were employed in the first and the second dimension, respectively in combination with photodiode array and mass spectrometry (LC×LC-PDA-MSMS) detection. To increase the peak capacity values by using RP modes in both dimensions, a comparison of a conventional full-in-fraction and shifted second dimension gradient was carried out. The separation capabilities of the comprehensive LC approaches tested allowed the analysis of such a complex natural sample without any pre-treatment to effectively reduce the interferences coming from the matrix.

**Keywords:** comprehensive LC, polyphenols, red wines, mass spectrometry

## 1. Introduction

Phenolic compounds are secondary metabolites synthesized by plants during normal development and in response to stress conditions. They embrace a considerable range of substances possessing an aromatic ring bearing one or more hydroxyl moieties. Produced and consumed world-wide, wine is an excellent natural source of various polyphenol families that go from phenolic acids (benzoic- or cinnamic-like derivatives) to different classes of flavonoids (flavones, flavan-3-ols, flavonols and anthocyanins).

Sometimes, the polyphenol content in real world-samples can be so complex that they cannot be resolved in a one-dimensional HPLC analysis. In order to overcome this problem, comprehensive two-dimensional liquid chromatography (LC×LC) employing two columns with different selectivity in the two dimensions could be a viable tool. In addition, in order to improve the peak distribution, different gradient elution strategies could be investigated to enhance the orthogonality degree, by means of specific elution gradient approaches to be used in the second dimension.

This technical report describes a novel LC×LC-PDA-MSMS (Fig. 1) instrument, capable of extremely high-resolution power, as well as targeted and untargeted analysis, that was successfully applied to the characterization of the polyphenol content a red wine sample (Fig. 2).



Fig. 1 LC×LC-PDA-MSMS instrumentation

## 2. Experimental

### 2-1. Reagents and Materials

LC-MS grade solvents for LC×LC analyses: water (H<sub>2</sub>O), acetonitrile (ACN); Acetic acid 99–100%, (glacial). All the solvents and chemicals were purchased from Sigma-Aldrich (Milan, Italy).

Chromatographic separations were carried out using columns provided by Supelco (Bellefonte, PA, USA): Ascentis Cyano (250 mmL. × 1 mmI.D., 5 μm d.p.), and Ascentis Express C<sub>18</sub> (30 mmL. × 4.6 mmI.D., 2.7 μm d.p.).

The red wine was purchased in a local market. The sample was filtered through a 0.45 μm Acrodisc nylon membrane (Pall Life Sciences, Ann Arbor, MI, USA) before injection.

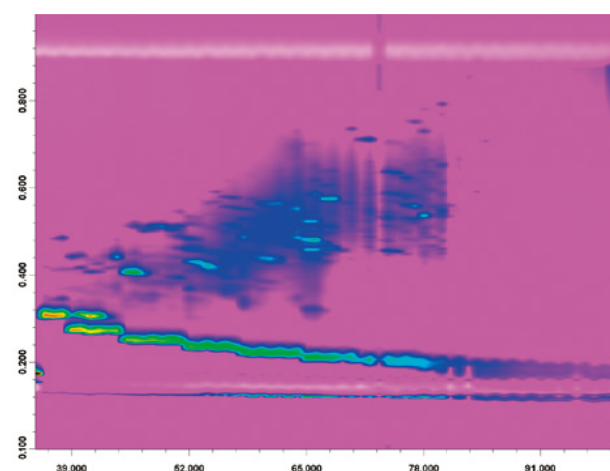

Fig. 2 RP-LC×RP-LC Plot of a red wine sample

<sup>1</sup> University of Messina, Italy  
<sup>2</sup> Chromaleont S.r.l.

## 2-2. Instrument

- Shimadzu CBM-20A controller
- Shimadzu LC-30AD dual-plunger parallel-flow pumps (D1-LC)
- Shimadzu DGU-20A<sub>SR</sub> degassing unit (D1-LC)
- Shimadzu LC-30AD dual-plunger parallel-flow pumps (D2-LC)
- Shimadzu DGU-20A<sub>SR</sub> degassing unit (D2-LC)
- Shimadzu CTO-20AC column oven
- Shimadzu SIL-30AC autosampler
- Shimadzu SPD-M30A photo diode array detector (1  $\mu$ L flow cell)
- Shimadzu LCMS-8030 (ESI source)

For connecting the two dimensions: two electronically-controlled 2-position, 6-port high pressure switching valves FCV-32AH (with two 20  $\mu$ L empty loops).

## 2-3. Software

- Shimadzu LabSolutions (Version 5.60 SP2)

## 2-4. 2D Software

- LCxLC-Assist
- ChromSquare (Version 2.0) from Chromaleont, Messina, Italy

## 3. LCxLC-MS Conditions

First dimension (D1) separations	
Column	: Ascentis Cyano
Flow rate	: 20 $\mu$ L/min
Mobile phases	: (A) 0.1% acetic acid in water (pH around 3); (B) acetonitrile 0.1% acetic acid.
Gradient elution	: 0.01 min, 2% B; 10 min, 2% B; 60 min, 50% B; 75 min, 100% B; 100 min, 100% B.
Backpressure (at analysis start)	= 40 bar
Injection volume	: 5 $\mu$ L
Second dimension (D2) separations	
Column	: Ascentis Express C18
Flow rate	: 2.5 mL/min
Mobile phases	: (A) 0.1% acetic acid in water (pH around 3); (B) acetonitrile 0.1% acetic acid.
Gradient elution	: FIF, full in fraction: 0.01 min, 0% B; 0.10 min, 0% B; 0.75 min, 50% B; 1.00 min, 0% B. SG, Shifted gradient: illustrated in Fig. 3
Backpressure (at analysis start)	= 170 bar
Modulation time of the switching valves	: 1 min.

### MS conditions

MS acquisition performed using the ESI interface operating in negative ionization mode:

mass spectral range: 100–800  $m/z$ ; event time: 0.1 sec; scan speed: 7500  $u/s$ ; nebulizing gas ( $N_2$ ) flow: 2 L/min; drying gas ( $N_2$ ) flow: 15 L/min; Heat block temperature: 250  $^{\circ}C$ ; desolvation line (DL) temperature: 250  $^{\circ}C$ ; Interface voltage: 3.5 kV; detector voltage: 1.80 kV; The flow eluting from the second column was splitted before the MS instrument (approximately 0.4 mL/min to the MS).



Fig. 3 Scheme of the LCxLC-Assist software

## 4. Results and Discussion

In an LCxLC system, with two not orthogonal dimensions, an LCxLC separation most likely results in peaks concentrated around the main diagonal line of the separation area. A typical example is the LCxLC analysis of a red wine sample, illustrated in Fig. 4A, by employing a Cyano column in the D1 and a C18 column in the D2 using the conventional full-in-fraction approach.

As a matter of fact, a clear correlation of the D1 and D2 and a small peak-distribution area were observed because the separation mechanisms in the two dimensions were similar. The analytes eluted early in the D1 were only weakly retained in the D2; the analytes eluted in the middle of the D1 were eluted in the middle of the D2 and the analytes eluted late in the D1 were strongly retained in the D2.

To overcome such a limitation, we used a narrower organic solvent span changing the gradient program according to the elution properties. The shifted gradient program, led to a greater coverage of the separation space (Fig. 4B). The blue line is the program of the D1 run and the red line is that of the D2 run. The D2 gradient covered a narrow organic solvent range, which varied continuously during the LCxLC run. The gradient program started with 0% acetonitrile and rose to 20% ACN over 0.75 min; at the end of the analysis, the gradient program in the D2 starts at 10% acetonitrile and rose to 50% acetonitrile. At the end of the analysis, the higher percentage of organic solvent made possible the efficient elution of the strongly retained compounds.

As can be seen from Fig. 4B regarding the red wine sample analyzed with LCxLC with a shifted gradient in the D2, a significant improvement in the retention space was attained (Fig. 5). In fact, the use of a shifted gradient with a gradual increase of the proportion of organic solvent gave better separation in the D2 with a less typical diagonal-line distribution. In addition, because of the narrower solvent range, the backpressure was much smoother and steadier.



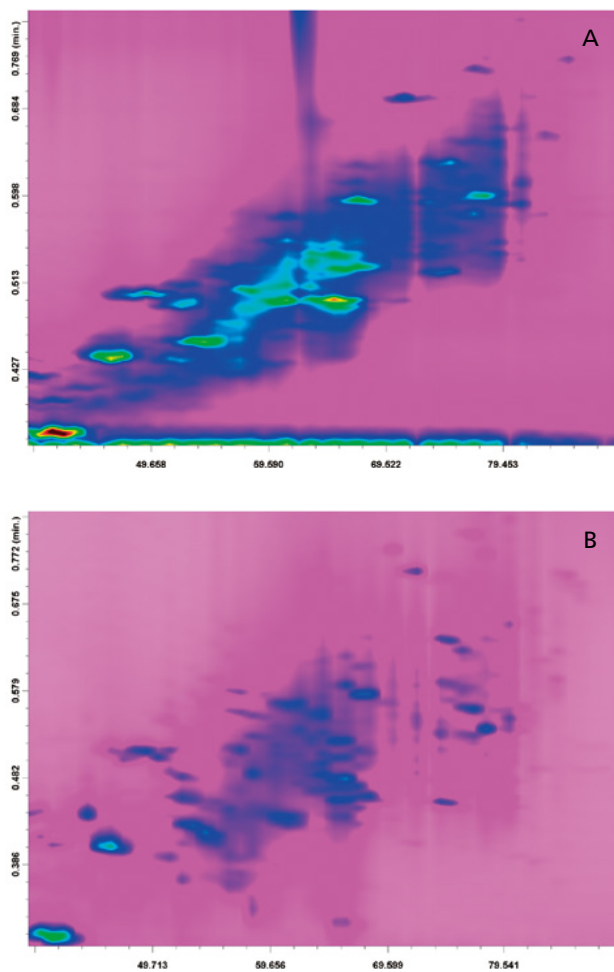

Fig. 4 Separation of a red wine sample by using the FIF (A) and the shifted gradient (B) approaches

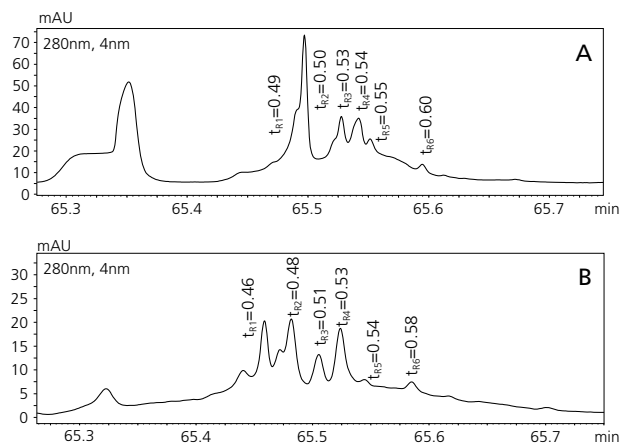

Fig. 5 Analysis of a red wine sample. A comparison of the second-dimension separation of the 65<sup>th</sup> fraction for both LCxLC plots shown in Fig. 4A–B.

An evaluation of the performance, in terms of peak capacity ( $n_c$ ), of the two different set-ups tested was carried out, considering both theoretical and practical peak capacity. The theoretical peak capacity values, multiplicative of the individual values obtained for the two dimensions ( $^1n_c \times ^2n_c$ ), yielded values as high as 690 and 570 for the full in fraction and for the shifted gradients, respectively.

As expected, due to the partial correlation of the two dimensions, “practical” peak capacity values, corrected for both undersampling (number of fractions effectively transferred from the D1 to the D2) and orthogonality (separation space effectively covered by sample compounds), were significantly lower at 75 and 216. The set-up with the use of the shifted second dimension gradients was the most efficient one since it less suffered from the correlation of the two dimensions tested (Table 1).

Selected ion extracted chromatograms for some target compounds occurring in the red wine sample along the relative mass spectra are illustrated in Fig. 6.

Table 1 Relative performances, in terms of peak capacity,  $n_c$ , of the two set-up investigated

	Full in fraction gradient	Shifted gradient
$^1n_c$	15	15
$^2n_c$	46	38
Theoretical D2 $n_c$	690	570
Practical D2 $n_c$	75	216

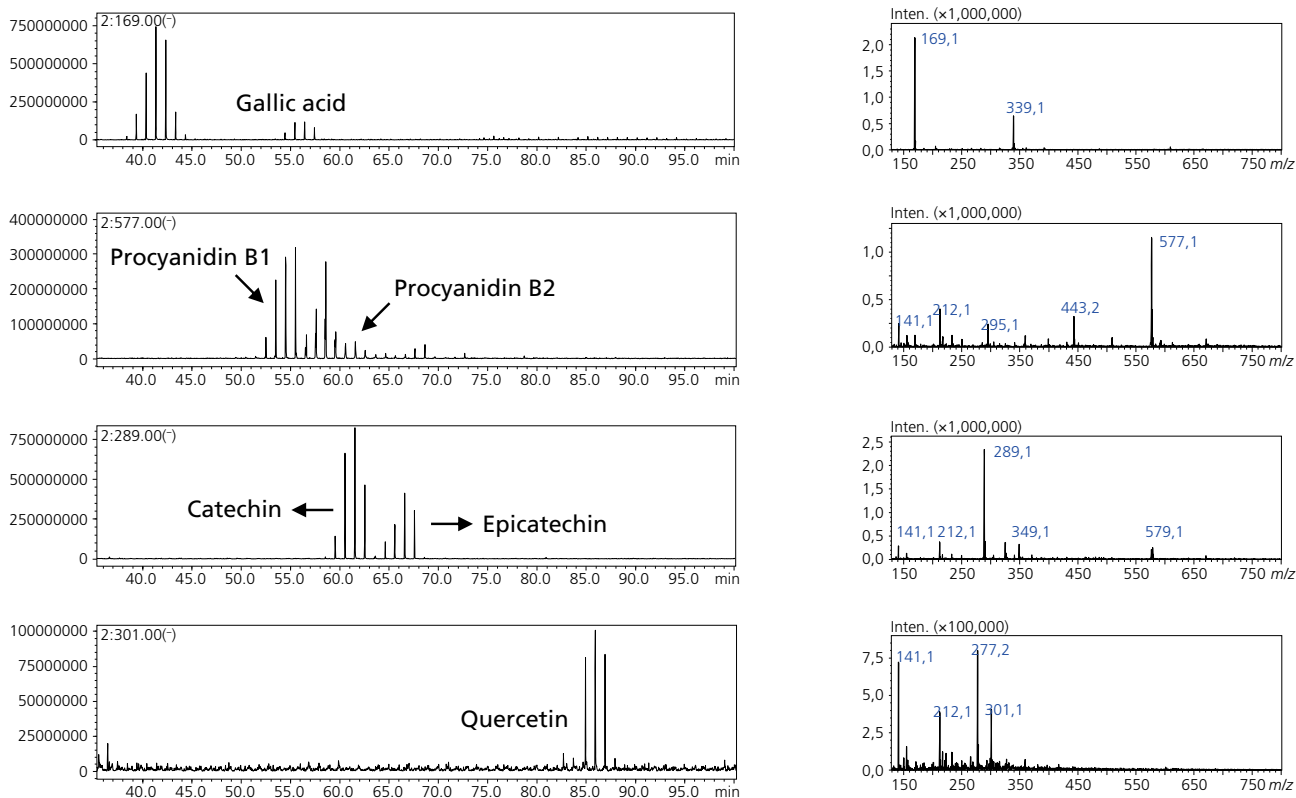

Fig. 6 Ion extracted chromatograms (on the left) along with relative mass spectra (on the right) of the main polyphenolic compounds identified in the red wine sample investigated

## 5. Conclusions

A comprehensive two-dimensional liquid chromatography system, based on the use of a micro cyano column and a partially porous ( $C_{18}$ ) column in the first and second dimension, respectively, in combination with photodiode array and mass spectrometry detection, is presented.

Two second dimension gradient approaches, namely full in fraction and shifted were investigated and compared in terms of peak capacity.

The shifted gradient method used increased the effective peak-distribution area in the LCxLC analysis of a red wine sample.

Therefore, the use of a shifted gradient in an LCxLC system brings about a significant improvement in separation power and is a great advantage in the analysis of such complex samples.

# Application News

## No.L491

High Performance Liquid Chromatography

### Comprehensive 2D Separation of Carotenoids in Red Chili Pepper by the Nexera-e System

Carotenoids are naturally occurring organic pigments that are divided into two classes, carotenes, consisting only of carbon and hydrogen, and xanthophylls, which contain oxygen. Carotenoids are rich in double bonds, and therefore have received much attention in recent years as antioxidants, which are known for their disease preventive properties, including lifestyle-related diseases.

The extensive range of carotenoids found in foods makes it difficult to conduct simultaneous separation and quantitation by conventional HPLC. However, the Nexera-e comprehensive two-dimensional LC is particularly suited for such analyses. Here, carotenoids extracted from red chili pepper were subjected to two-dimensional analysis, in which micro-scale separation was conducted in the first stage using normal phase conditions, and separation using reversed phase conditions was tried in the second dimension. For detection, a combination of a photodiode array (PDA) connected to the LCMS-8030 triple quadrupole mass spectrometer was used. Because the separation modes, normal and reversed phases, differ in the first and second dimensions, this might be considered a two-dimensional LC method by which the greatest orthogonality possible is obtained.

#### Comprehensive Separation of Carotenoids Detected by the Photodiode Array Detector

Use of the Nexera-e with a photodiode array detector (PDA) permits the separation of complex coexisting substances and detection at the optimal wavelength in a single analysis. Fig. 1 shows a comprehensive two-dimensional representation of the separation pattern (absorption wavelength = 450 nm) generated using the specialized two-dimensional analysis software, ChromSquare.

By combining the first-dimension cyano column and the second-dimension ODS column, 10 groups of substances, including hydrocarbons, monoal esters, diol diesters, diol monoketo diesters, diol diketo diesters, diol mono epoxide monoesters, free monoals, diol monoketo monoesters, diol diketo mono esters, and polyoxygenated free xanthophylls were separated according to class based on molecular polarity, and the component separation was verified based on the hydrophobicity of their respective fatty acid residues.

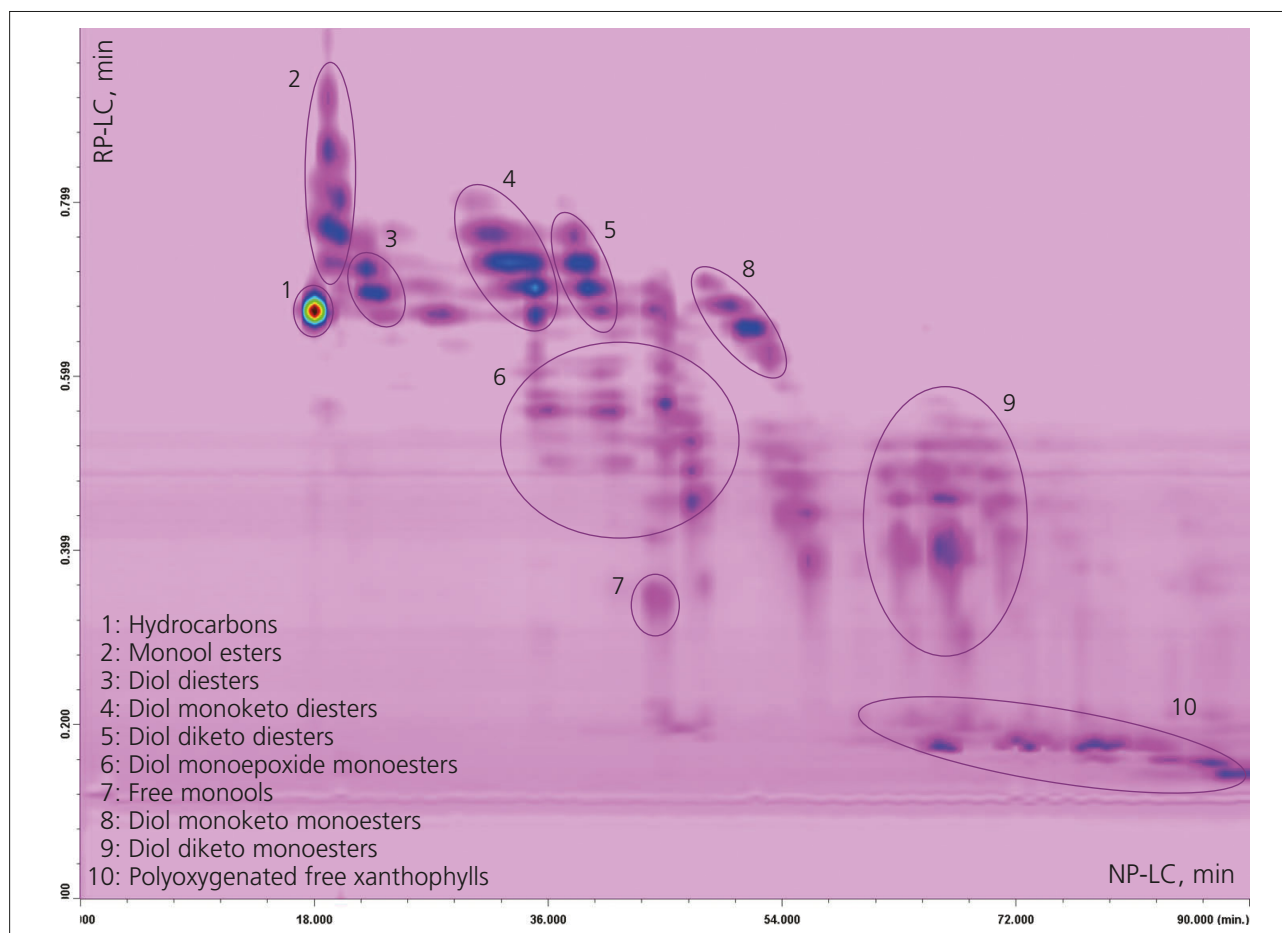

Fig. 1 2D Plot of Carotenoids Using ChromSquare Software

### ■ Quantitation of $\beta$ -Carotene in Red Chili Pepper by LC/MS/MS

The analytical conditions are shown in Table 1, and the sample pretreatment conditions are shown in Fig. 2.  $\beta$ -carotene, which is a precursor of vitamin A, was detected in the two-dimensional separation of the carotenoids. Quantitation was then conducted using the LCMS-8030 triple quadrupole mass spectrometer. Both high sensitivity and high selectivity can be obtained using MRM analysis, and further, reduced ion suppression can be expected with the two-dimensional

separation obtained with the Nexera-e. Fig. 3 shows the two-dimensional separation data of  $\beta$ -carotene obtained from DUIS-positive mode MRM analysis of the calibration curve, and Fig. 4 shows the linearity of the three values (blobs) in the range of 0.01 to 10 mg/L, which correspond to the peak volumes used for quantitation. The correlation coefficient ( $r$ ) = 0.998976 indicates results with good linearity. The quantitative result for  $\beta$ -carotene present in red chili pepper was calculated as 1.22 mg/L based on the concentration in the final sample following extraction.

**Table 1 Analytical Conditions**

1D Column	: Ascentis Cyano (250 mm L. x 1.0 mm I.D., 5 $\mu$ m)
Mobile Phase	: A; Hexane B; Hexane/Butylacetate/Acetone = 80/15/5 (v/v/v)
Flowrate	: 0.02 mL/min
Time Program	: B Conc. 0 % (0.01 min) $\rightarrow$ 0 % (5 min) $\rightarrow$ 100 % (65 min) $\rightarrow$ 100 % (75 min) $\rightarrow$ 0 % (76 min)
Column Temp.	: 30 $^{\circ}$ C
Injection vol.	: 2 $\mu$ L
Loop vol.	: 20 $\mu$ L
2D Column	: Ascentis Express C18 (30 mm L. x 4.6 mm I.D., 2.7 $\mu$ m)
Mobile Phase	: A; acetonitrile B; 2-propanol
Flowrate	: 4 mL/min (0.8 mL/min split for MS)
Time Program	: B Conc. 0 % (0.01 min) $\rightarrow$ 50 % (0.17 - 0.54 min) $\rightarrow$ 80 % (0.54 - 0.93 min) $\rightarrow$ 30 % (0.94 min) $\rightarrow$ STOP (1 min)
Detector	: SPD-M30A Photo diode array detector (standard cell, wave length = 450 nm) Shimadzu LCMS-8030 (DUIS positive mode, targeted $\beta$ -carotene MRM transition: $m/z$ 536.40 > 444.30)

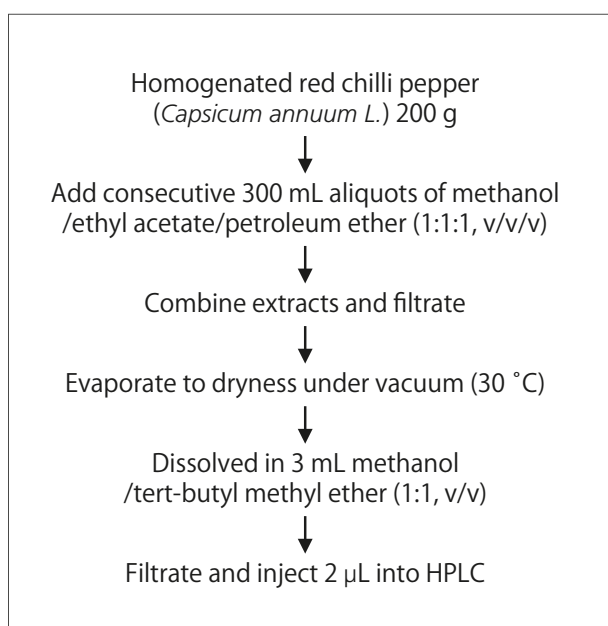

**Fig. 2 Sample Preparation**

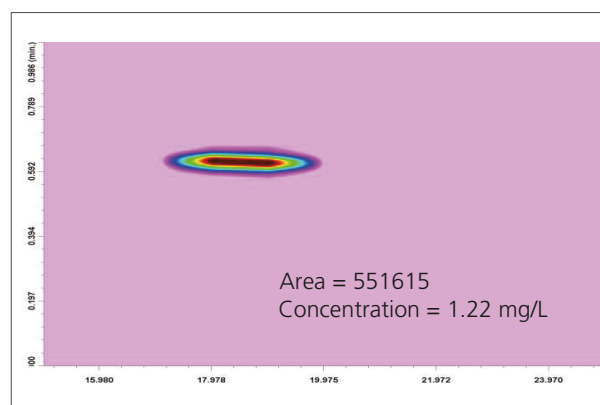

**Fig. 3 2D Plot of  $\beta$ -Carotene**

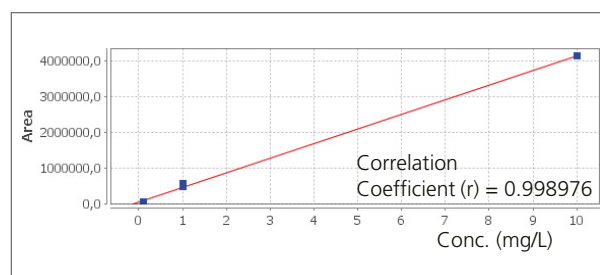

**Fig. 4 Linearity of Calibration Curve for  $\beta$ -Carotene**

Data provided by University of Messina Prof. Luigi Mondello and Chromaleont S.r.l.

First Edition: May, 2015

# Application News

## No.L492A

### High Performance Liquid Chromatography

## Comprehensive 2D Separation of Triglycerides in Vegetable Oil with ELSD/LCMS-IT-TOF Detection

Triglycerides, molecules consisting of a glycerol backbone to which three fatty acids are attached via ester bonds, are considered important functional components in both animal oil and vegetable oil. Triglycerides display low solubility in aqueous solvents, and their separation has typically been conducted by either silver ion-mediated normal phase analysis or reversed phase analysis using an organic solvent. However, as there are numerous molecular species consisting of combinations of fatty acids, mutual separation of the triglycerides in natural fats can be difficult using any single set of separation conditions. The Nexera-e comprehensive two-dimensional liquid chromatograph effectively achieves mutual separation of such complex components.

When conducting comprehensive two-dimensional liquid chromatography, different separation modes are generally selected for the first and second-dimension separations, and depending on the differences in separation selectivity between these dimensions, improved separation is typically seen for components that are difficult to separate in a single, one-dimensional analysis. Here, using borage oil as a sample that contains many triglycerides, micro-scale separation was conducted in the first separation using a silver column (normal phase conditions), and reversed phase separation was conducted in the second dimension by using a two-liquid gradient with non-aqueous organic solvents. Detection was conducted using a combination of an evaporative light scattering detector (ELSD) and an ion trap time-of-flight mass spectrometer (LCMS-IT-TOF). The analytical conditions are shown in Table 1.

### Comprehensive Separation of Triglycerides in Borage Oil with ELSD Detection

Borage oil is a vegetable oil that is obtained from the seeds of *Borago officinalis*, an annual herb. Rich in triglycerides containing such fatty acid chains as linoleic acid,  $\gamma$ -linolenic

acid, oleic acid, and palmitic acid, it offers a variety of health effects associated with these substances, such as moisturizing effect, wrinkle prevention, etc. Compared with other vegetable oils, Borage oil is rich in  $\gamma$ -linolenic acid, which is said to be effective in maintaining female hormonal balance. Triglycerides in natural fats and oils are generally characterized by the lengths of their alkyl chains and the number and positions of the double bonds in the alkyl chains. Triglycerides having double bonds in particular are said to possess antioxidant action, and there is considerable demand for the separation of these triglycerides depending on the presence or absence of double bonds. It is known that strong interaction is displayed by the formation of a complex comprising the double bond of an alkyl chain with a silver ion. Utilizing this property, an HPLC method in which a stationary phase impregnated with silver is relatively often used to achieve selective retention of compounds containing double bonds. Here, using the Nexera-e to achieve comprehensive separation of multiple components, a silver ion column (normal phase conditions) with strong retention for double bonds was used for the first-dimension separation, an ultra-high-speed reversed phase analytical column was used for the second-dimension separation, and an ELSD was used for detection.

The ELSD converts the target compound to fine particles by evaporating the eluent exiting the column, and by measuring the scattered light, triglycerides, which display almost no UV absorption, are effectively detected. Fig. 1 shows a comprehensive two-dimensional representation of the separation pattern (horizontal axis: separation in the first dimension with a silver ion column  $\times$  vertical axis: reversed phase separation in the second dimension) generated using the specialized two-dimensional analysis software, ChromSquare. The use of comprehensive two-dimensional separation permitted difficult-to-achieve high separation using a single set of separation conditions, by which thirty-seven of the elution peaks were confirmed.

**Table 1 Analytical Conditions**

[Column1]	: Ag custom column (150 $\times$ 1.0 mm; 5.0 $\mu$ m)
Mobile Phase	: A; 1.5 % v/v of Butyronitrile in n-Hexane B; 2.4 % v/v of Butyronitrile in n-Hexane
Time Program	: B Conc. 0 % (0 min) $\rightarrow$ 100 % (40 min) $\rightarrow$ 100 % (150 min)
Flowrate	: 0.007 mL/min (split)
Column Temp.	: 30 $^{\circ}$ C
Injection Volume	: 2 $\mu$ L
Modulation Time	: 1.5 min
[Column2]	: Ascentis Express C18 column (Supelco, 50 $\times$ 4.6 mm; 2.7 $\mu$ m)
Mobile Phase	: A; Acetonitrile B; Isopropanol
Time Program	: B Conc. 30 % (0 min) $\rightarrow$ 30 % (0.08 min) $\rightarrow$ 40 % (0.1 min) $\rightarrow$ 70 % (1.2 min) $\rightarrow$ 30 % (1.21 min) $\rightarrow$ 30 % (1.5 min)
Detector	: Shimadzu ELSD LT-II
Flowrate	: 4 mL/min
Evaporative Temperature	: 58 $^{\circ}$ C
Nebulizing Gas Pressure	: 260 kPa
Detector	: LCMS-IT-TOF
Flowrate	: 2 mL/min from the 2D pump was split to 0.8 mL/min prior entering the APCI probe.
[MS Conditions]	
Ionization Mode	: APCI positive
Nebulizer Gas Flow	: 2.0 L/min
Interface Temperature	: 400 $^{\circ}$ C
Block Heater Temperature	: 230 $^{\circ}$ C
CDL Temperature	: 230 $^{\circ}$ C
Scan	: <i>m/z</i> 300-1200

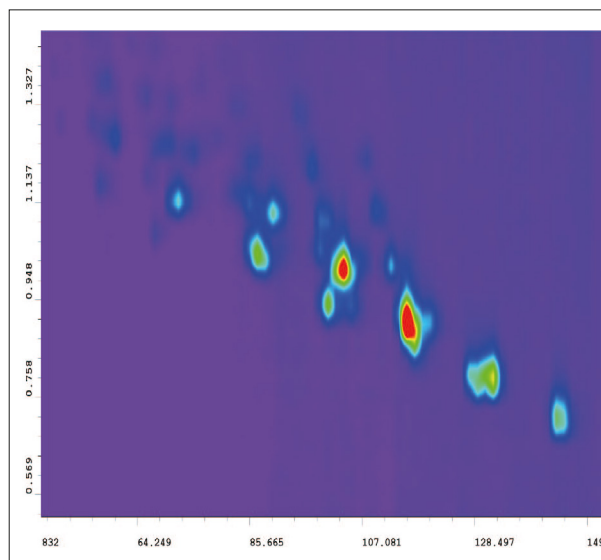

**Fig. 1 Comprehensive 2D Plot of Triglycerides in Borage Oil with ELSD Detection**



### Comprehensive Separation of Triglycerides in Borage Oil with LCMS-IT-TOF Detection

As mentioned above, separation in the first dimension in this analysis is conducted based on the presence or absence or the difference in the number of double bonds in the fatty acid side chain. When a silver ion column is used, the greater the number of double bonds in the triglyceride, the stronger the retention will be. However, it is also possible that retention will be affected depending on the positions of the double bonds or the side chain length. In the second-dimension reversed phase separation, two-solution gradient elution is adopted in which, due to the high hydrophobicity of triglycerides, neither water nor buffer solution, etc., is used, but a non-aqueous organic solvent is used for the mobile phase. With this separation mode, elution tends to proceed in the order obtained by subtracting twice the number of double bonds from the total number of triglyceride carbon atoms, which is referred to as the partition number. The top portion of Fig. 2 shows a two-dimensional plot drawn based on the output of the LCMS-IT-TOF mass spectrometer. To facilitate identification of triglycerides using the order of elution described above, a grid is drawn superimposed on the plot. From this plot, it can be seen how separation is conducted according to the difference in the number of double bonds in the first dimension, and the difference in

partition number in the second dimension.

Use of the LCMS-IT-TOF as the detector for precise mass measurement in the second dimension permits detailed qualitative analysis of the many components eluted following separation by the Nexera-e. The mass spectra corresponding to the white-circled peaks A, B and C of Fig. 2 are shown in the lower part of Fig. 2. The structural information was obtained from the peak of diglyceride with one side chain detached, and the triglyceride structure were determined as follows:

- A : POP
- B : OOP
- C :  $\gamma$ LnP

Where,

- P : Palmitic acid
- O : Oleic acid
- $\gamma$ Ln :  $\gamma$ -Linolenic acid

Since these compounds each have one to three double bonds, they are eluted from the first-dimension column in this order. As lipid-related compounds often display no UV absorption, and gradient elution cannot be applied with differential refractive index detection, a combination of the Nexera-e and ELSD, or a triple quadrupole or LCMS-IT-TOF mass spectrometer can be considered essential for exhaustive analysis in this field.

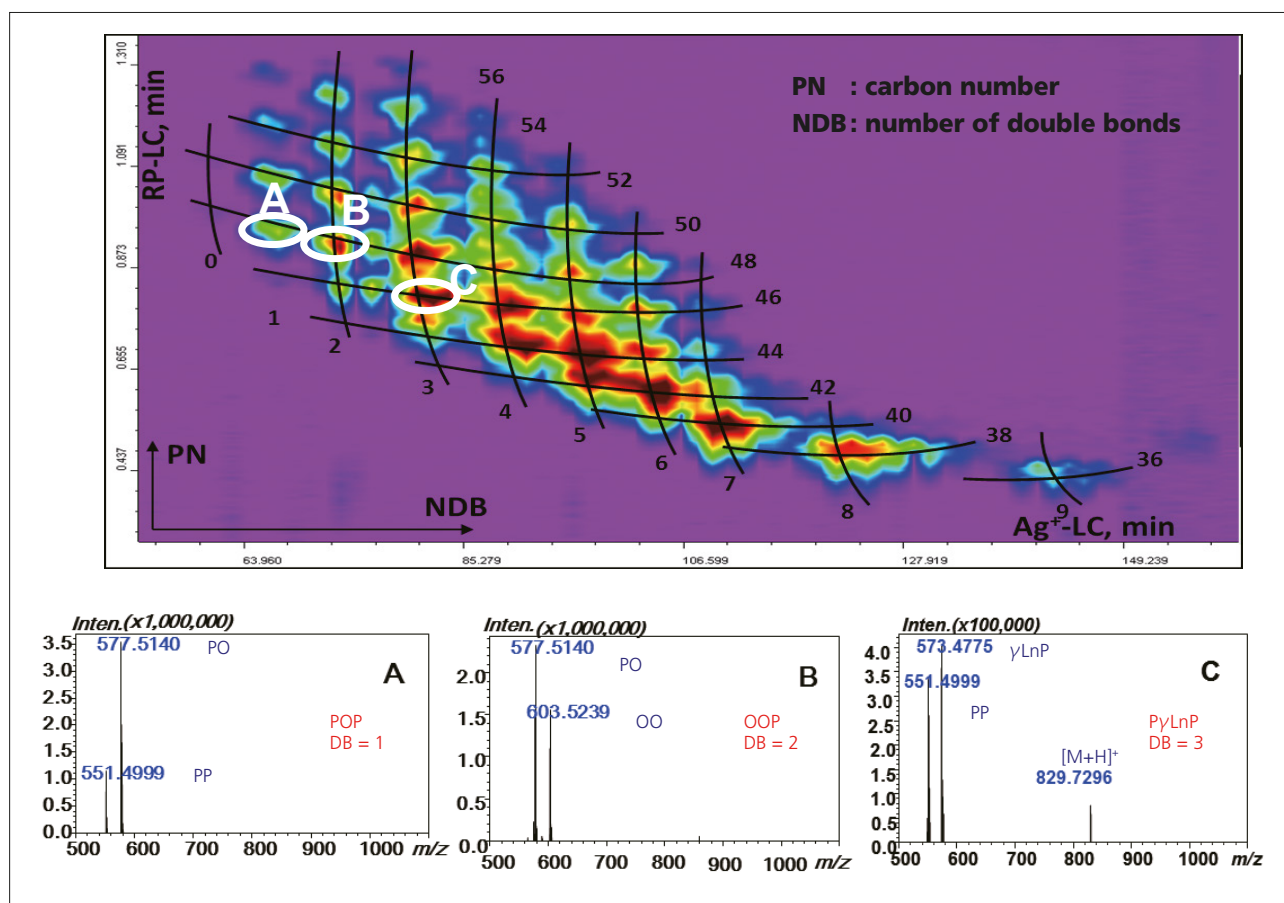

Fig. 2 Comprehensive 2D Plot of Triglycerides in Borage Oil with LCMS-IT-TOF in Addition to the Mass Spectra of Assigned Blobs

Data provided by University of Messina Prof. Luigi Mondello and Chromaleont S.r.l.

# Application News

## No. L500

### High Performance Liquid Chromatography

## Analysis of Aflatoxin B<sub>1</sub>, B<sub>2</sub>, G<sub>1</sub> and G<sub>2</sub> in Kakkonto Using Nexera-i and RF-20A<sub>XS</sub>

Aflatoxins are a type of mycotoxins that cause severe and acute toxicity. They are also carcinogenic, and testing for aflatoxins is required for crude drugs produced from natural plants or preparations that contain crude drugs. "Analytical methods for aflatoxins in crude drug and its product" was published in Japanese Pharmacopoeial Forum as a proposed revision for the 17th Edition of the Japanese Pharmacopoeia (as of July 2015). This test method proposal proposes a reference level of  $\leq 10 \mu\text{g}/\text{kg}$  for total aflatoxins (sum of aflatoxin B<sub>1</sub>, B<sub>2</sub>, G<sub>1</sub> and G<sub>2</sub>).

This Application News introduces an example analysis of the complex crude drug Kakkonto based on the proposed revision to the Japanese Pharmacopoeia 17th Edition. The proposed revision explains a method of analyzing aflatoxins using a fluorescent detector after derivatization with trifluoroacetic acid (TFA). This Application News describes an example analysis performed using this method, and another example analysis performed without derivatization but with direct fluorescence detection.

Aflatoxins in food are subject to regulation all over the world, and in Japan, a regulation\*<sup>1)</sup> and notification test method\*<sup>2)</sup> for aflatoxins have been published. See previous Application News L351, L422, L428, L430 and L435 for example analyses of aflatoxins in food performed using these test methods.

### ■ Analysis with Trifluoroacetic Acid Derivatization

When in a polar solvent, aflatoxins B<sub>1</sub> and G<sub>1</sub> are known to have a lower fluorescence intensity compared to aflatoxins B<sub>2</sub> and G<sub>2</sub>. Possible methods of increasing the fluorescence intensity are derivatization with a photochemical reactor, TFA derivatization, and electrochemical derivatization. This Application News uses the TFA derivatization method that appears in the proposed test method. The TFA derivatization reaction is commonly known as the pre-column method, and involves derivatization of the analytical sample before HPLC analysis. The structures of each aflatoxin before and after TFA derivatization are shown in Fig. 1.

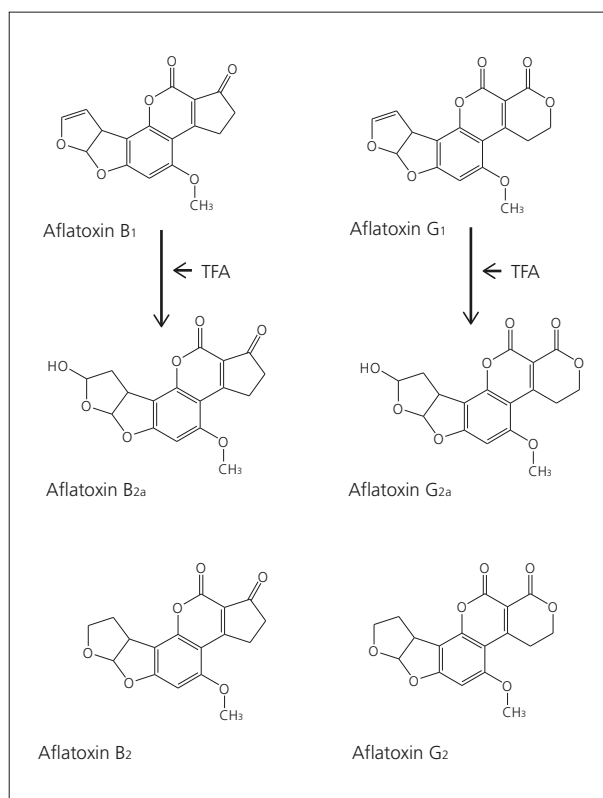

Fig. 1 Structures of Aflatoxin B<sub>1</sub>, B<sub>2</sub>, G<sub>1</sub> and G<sub>2</sub> and Aflatoxin Structures After TFA Derivatization (B<sub>2a</sub> and G<sub>2a</sub>)

Aflatoxin standard solution was added to the complex crude drug Kakkonto prior to analysis. The pretreatment procedure is shown in Fig. 2. This pretreatment was performed based on the proposed revision to the Japanese Pharmacopoeia 17th Edition. An AFLAKING immunoaffinity column (Horiba, Ltd.) was used in a cartridge to remove impurities. Aflatoxin standard solution was added to the crude drug sample so each aflatoxin was present at a concentration of 0.25 µg/kg (total 1 µg/kg). This is equivalent to 1/10th the reference concentration stipulated in the proposed revision to the Japanese Pharmacopoeia 17th Edition.

The example analysis of Kakkonto is shown in Fig. 3, and the analytical conditions are shown in Table 1. An example analysis of the sample with no added aflatoxin standard solution is also shown for comparison. Since an impurity peak was found after aflatoxin B<sub>2</sub>, which is the last eluted aflatoxin, a column cleaning process was added to the procedure. See Application News L428 for an example analysis of the standard solution.

**Table 1 HPLC Analytical Conditions**

System	: Nexera-i
Column	: Shim-pack FC-ODS (150 mm L. × 4.6 mm I.D., 3 µm)
Mobile Phase	: A; Water/methanol/acetonitrile = 6/3/1 (v/v/v) : B; Acetonitrile
Time Program	: A Conc. /B Conc. = 100/0 (0.00 - 15.00 min) → 10/90 (16.00 - 23.0 min) → 100/0 (24.00 - 34.00 min)
Flowrate	: 0.80 mL/min
Column Temp.	: 40 °C
Injection Volume	: 20 µL
Detection	: RF-20A <sub>XS</sub> , Ex. at 365 nm, Em. at 450 nm
Cell Temp.	: 25 °C

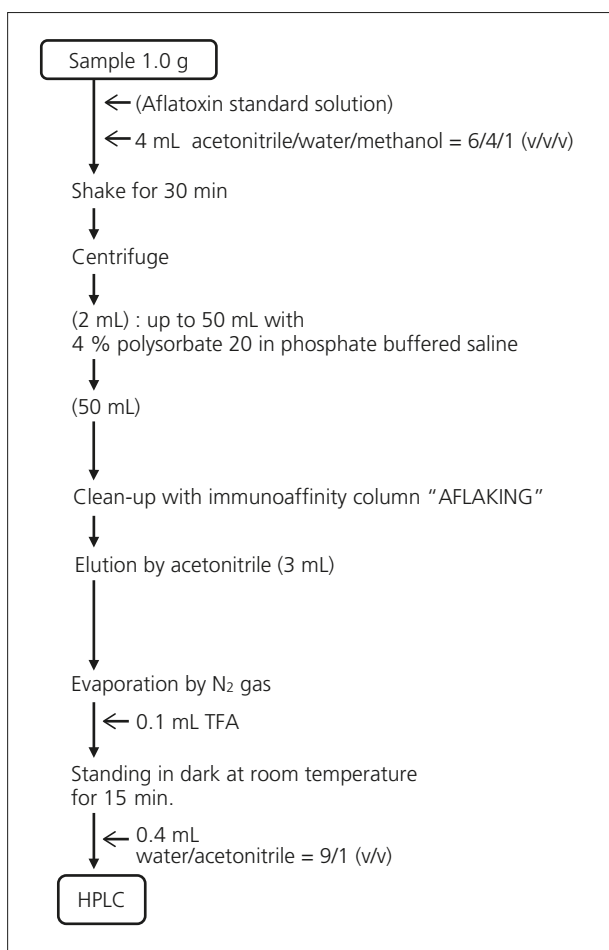

**Fig. 2 Pretreatment Procedure**

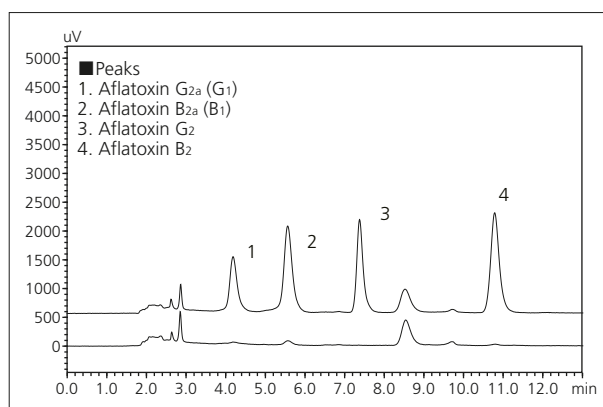

**Fig. 3 Chromatogram of Kakkonto After TFA Derivatization —HPLC Analysis (Upper: With Standard Solution, Lower: Without Standard Solution)**

### ■ Analysis by Direct Detection

Although aflatoxins B<sub>1</sub> and G<sub>1</sub> have a low fluorescence intensity, using the RF-20A<sub>XS</sub> highly-sensitive fluorescence detector allows for direct detection without derivatization. We performed direct detection using the RF-20A<sub>XS</sub>, and also attempted to shorten the analysis time by using the Shim-pack XR-ODS II high-performance column. Fig. 4 shows analysis of the aflatoxin standard solution without TFA derivatization (each aflatoxin at 20 µg/L), and Fig. 5 shows the same analysis performed at low concentrations (each aflatoxin at 0.1 µg/L). Analytical conditions are shown in Table 2. The relative standard deviation (n=6) of the area measured upon analysis of aflatoxin B<sub>1</sub> at 0.1 µg/L was 2.6 %. This result shows that sufficient analytical sensitivity can be obtained by using the RF-20A<sub>XS</sub> even without performing TFA derivatization. Using the RF-20A<sub>XS</sub> also shortens the analysis time to approximately 1/3rd of the analysis time with TFA derivatization. Fig. 6 shows the calibration curves for each aflatoxin in the concentration range of 0.1 to 20 µg/L. Good linearity was obtained with all four compounds, with an R<sup>2</sup> of 0.9999 or above.

**Table 2 UHPLC Analytical Conditions**

System	: Nexera-i
Column	: Shim-pack XR-ODS II (100 mm L. × 3.0 mm I.D., 2.2 µm)
Mobile Phase	: A; Water : B; Methanol : C; Acetonitrile
Time Program	: A Conc. /B Conc. /C Conc. = 65/30/5 (0.00 - 5.50 min) → 15/5/80 (5.51 - 7.0 min) → 20/80/0 (7.01 - 9.00 min) → 65/30/5 (9.01 - 12.00 min)
Flowrate	: 1.00 mL/min
Column Temp.	: 50 °C
Injection Volume	: 10 µL
Detection	: RF-20A <sub>XS</sub> , Ex. at 365 nm, Em. at 450 nm
Cell Temp.	: 25 °C

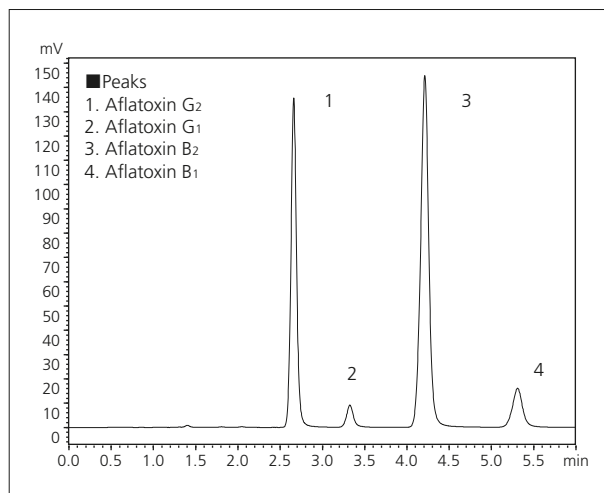

**Fig. 4 Chromatogram of Aflatoxin Standard Solution by Direct Detection—UHPLC Analysis (each 20 µg/L, 10 µL)**

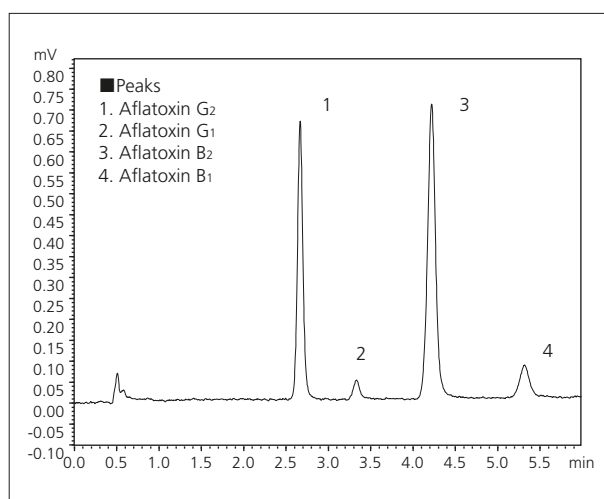

**Fig. 5 Chromatogram of Aflatoxin Standard Solution by Direct Detection—UHPLC Analysis (each 0.1 µg/L, 10 µL)**

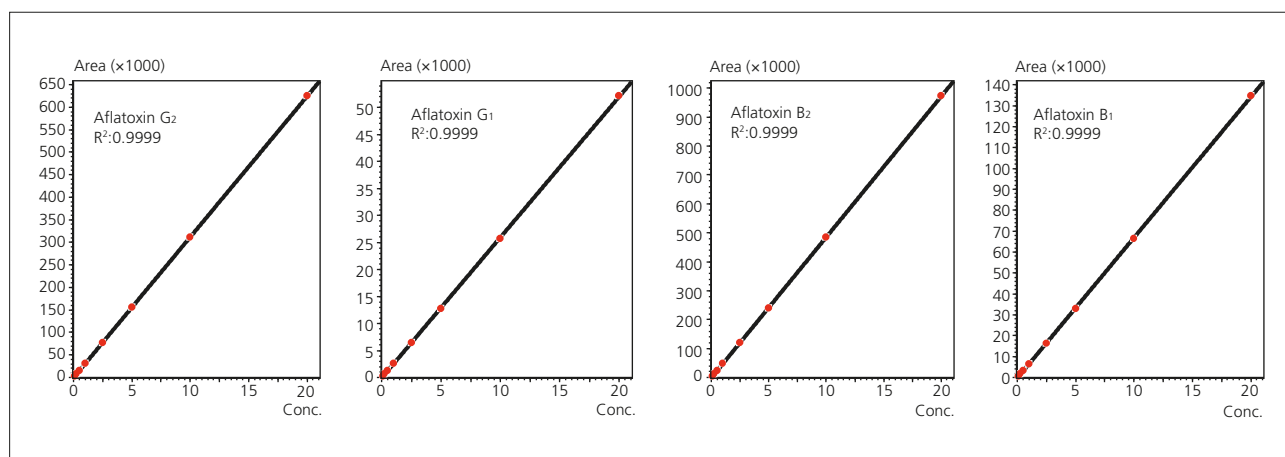

**Fig. 6 Aflatoxin Standard Solution Calibration Curves—Direct Detection (each 0.1 to 20 µg/L, 10 µL)**

Identical to the analysis with TFA derivatization, aflatoxin standard solution was added to the complex crude drug Kakkonto and analysis performed. The pretreatment procedure is shown in Fig. 7. An AFLAKING immunoaffinity column (Horiba, Ltd.) was also used in a cartridge to remove impurities. The pretreatment procedure up to this purification step is identical to that shown in Fig. 2. Aflatoxin standard solution was added to the crude drug sample so each aflatoxin was present at a concentration of 0.25 µg/kg (total 1 µg/kg). This is equivalent to 1/10th the reference concentration stipulated in the proposed revision to the Japanese Pharmacopoeia 17th Edition.

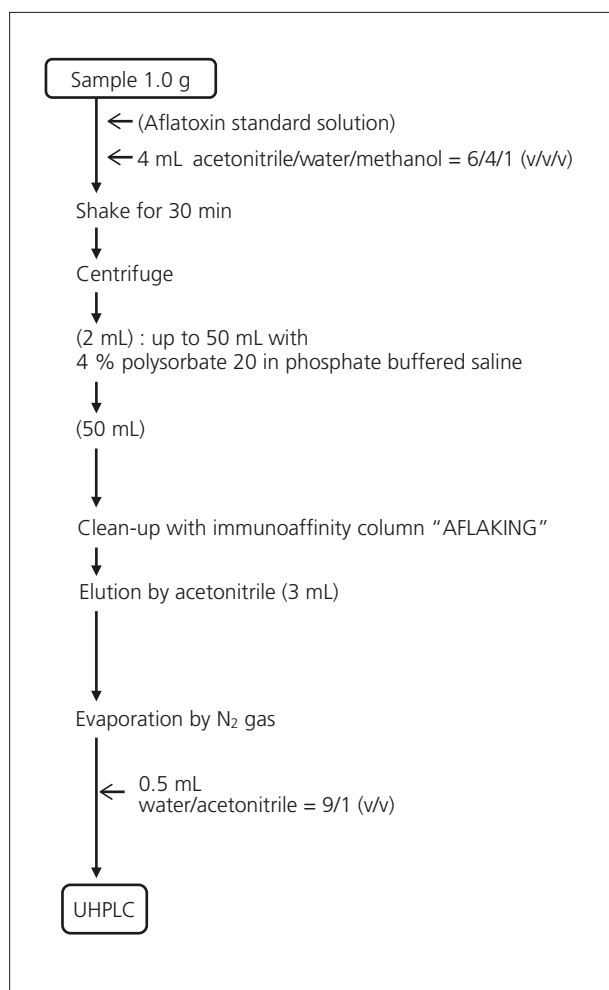

Fig. 7 Pretreatment Procedure

Note: Aflatoxins are degraded by UV light and while in solution will adsorb to glass surfaces. The vials used in analyses were pre-cleaned, low-adsorption brown glass vials.

- \*1) "Handling of Foods Containing Aflatoxins" (Japanese Ministry of Health, Labour and Welfare, Dept. of Food Safety Notification 0331 No. 5, March 31, 2011)
- \*2) "Test Method for Total Aflatoxins" (Japanese Ministry of Health, Labour and Welfare, Dept. of Food Safety Notification 0816 No. 2, August 16, 2011)

The example analysis of Kakkonto is shown in Fig. 8, and the analytical conditions are shown in Table 2. Although an impurity peak was eluted between aflatoxin G<sub>1</sub> and B<sub>2</sub> despite use of the immunoaffinity column, the impurity peak was fully separate from the two aflatoxin peaks, and the analysis time was completed in 12 minutes even after adding a cleaning process.

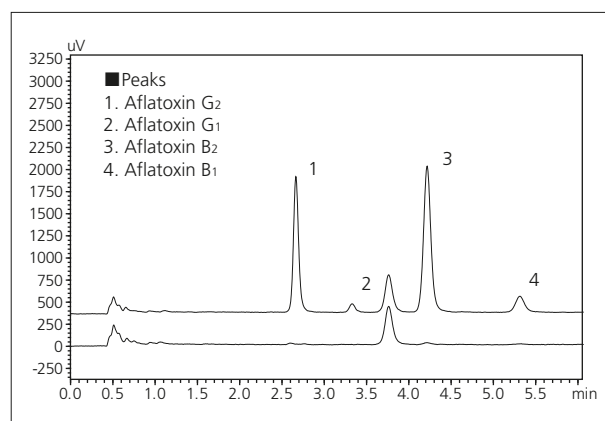

Fig. 8 Chromatogram of Kakkonto by Direct Detection—UHPLC Analysis  
(Upper: With Standard Solution, Lower: Without Standard Solution)



# Application News

## No. L484

### High Performance Liquid Chromatography

## Analysis of Nivalenol and Deoxynivalenol in Wheat Using Prominence-i

Nivalenol and deoxynivalenol (DON, vomitoxin) are types of mycotoxins produced by *Fusarium* fungi. In Japan, the provisional reference value for deoxynivalenol was set at 1.1 ppm in May, 2002 (Notification No. 0521001 issued by Department of Food Safety, Pharmaceutical and Food Safety Bureau, Ministry of Health, Labour and Welfare of Japan). Previously, in Application News No. L362, the analysis using an ultra high-performance LC system was introduced, but here, referring to the test method for deoxynivalenol specified in the Notification No. 0717001 (issued by Department of Food Safety, Pharmaceutical and Food Safety Bureau, Ministry of Health, Labour and Welfare of Japan, in July 2003), a washing process for the analytical column is included.

The detector component of the new Prominence-i integrated high-performance liquid chromatograph incorporates a temperature control function for both the flow cell component and the optical system. Here, good repeatability was obtained despite the susceptibility of UV detection in the short wavelength region due to environmental temperature fluctuations.

### ■ Analysis of Standard Mixture

Fig. 1 shows the results of analysis of a standard mixed solution of nivalenol and deoxynivalenol (each at 4.0 ppm) using a 10  $\mu$ L injection. Table 1 shows the analytical conditions used. The test method specifies the use of isocratic analysis, but a column washing process after elution of the deoxynivalenol was added. As the Prominence-i is equipped with a low-pressure gradient unit as standard, a mobile phase with a high organic solvent ratio can easily be pumped through the system following elution of the target component. Six repeat analyses of a 0.1 ppm standard solution were conducted, corresponding to about one-tenth the provisional reference value. The relative standard deviation (% RSD) of peak area and retention time obtained for the two substances are shown in Table 2, and the chromatogram is shown in Fig. 2.

**Table 1 Analytical Conditions**

Column	: Shim-pack GIS C18 (250 mm L. x 4.6 mm I.D., 5 $\mu$ m)
Mobile Phase A	: Water / Acetonitrile / Methanol = 90/5/5 (v/v/v)
Mobile Phase B	: Acetonitrile / Methanol = 50/50 (v/v)
Time Program	: B Conc. 0 % (0 - 20 min) $\rightarrow$ 50 % (20.01 - 25 min) $\rightarrow$ 0 % (25.01 - 45 min)
Flowrate	: 1.0 mL/min
Column Temp.	: 40 °C
Injection Volume	: 10 $\mu$ L
Detection	: UV 220 nm (Cell temp. 45 °C)

**Table 2 Repeatability (0.1 ppm, n=6)**

	R.T.%RSD	Area %RSD
Nivalenol	0.09	0.68
Deoxynivalenol	0.06	0.76

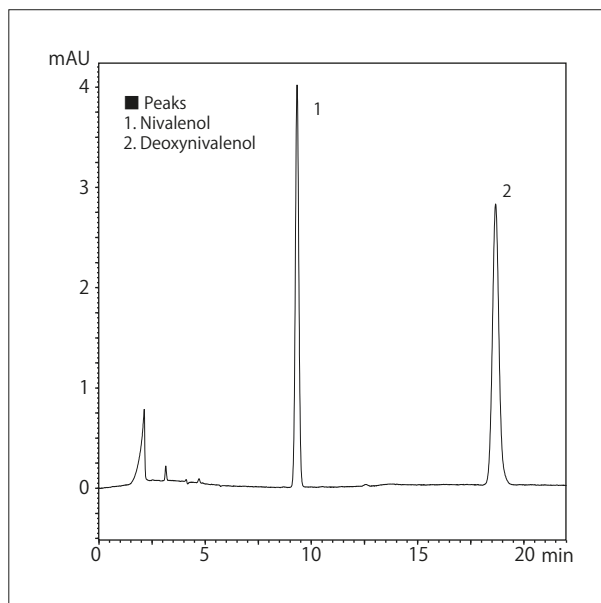

**Fig. 1 Chromatogram of a Standard Mixture (4.0 ppm each)**

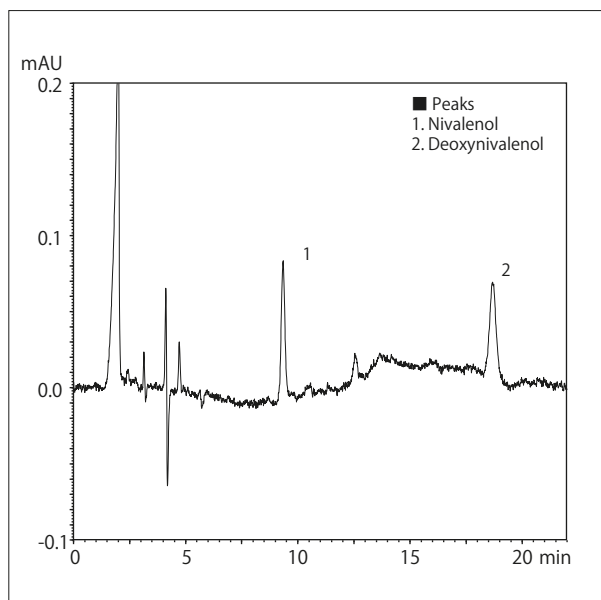

**Fig. 2 Chromatogram of a Standard Mixture (0.1 ppm each)**

### Calibration Curve Linearity

Fig. 3 shows the calibration curves generated from analyses using the conditions of Table 1. Excellent linearity with a coefficient of determination greater than  $R^2=0.9999$  was obtained for both substances over a concentration range of 0.1 to 4 ppm.

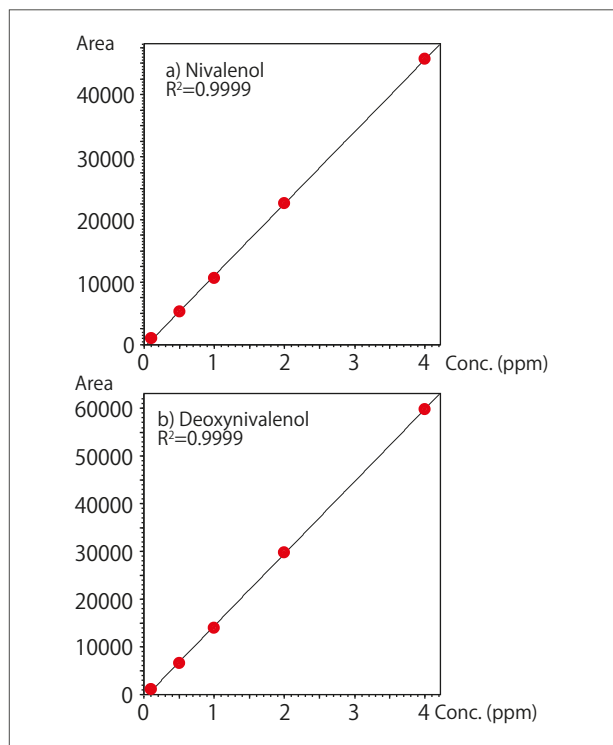

Fig. 3 Linearity of Calibration Curves for a) Nivalenol and b) Deoxynivalenol

### Analysis of Wheat

Fig. 4 shows the pretreatment procedure used for analysis of wheat. Purification of two varieties of wheat was conducted using two types of multi-function columns, the "MultiSep #227" (Romer Labs Inc.) and "Autoprep MF-T" (Showa Denko K.K.).

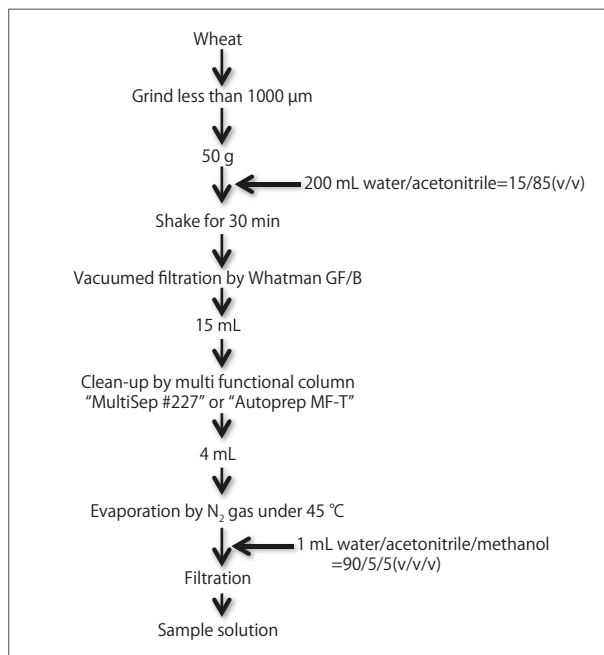

Fig. 4 Pretreatment

The results are shown in Fig. 5 and Fig. 6, respectively. Here, the pretreated sample solution was spiked with nivalenol and deoxynivalenol to achieve respective concentrations of 1.0 ppm.

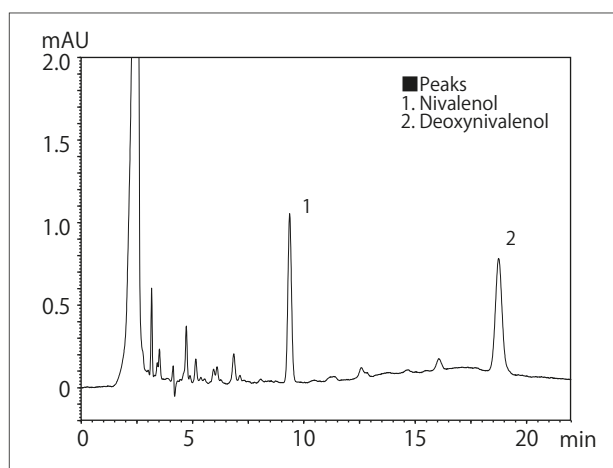

Fig. 5 Chromatogram of Wheat A (Spiked with 1.0 ppm each) (MultiSep #227)

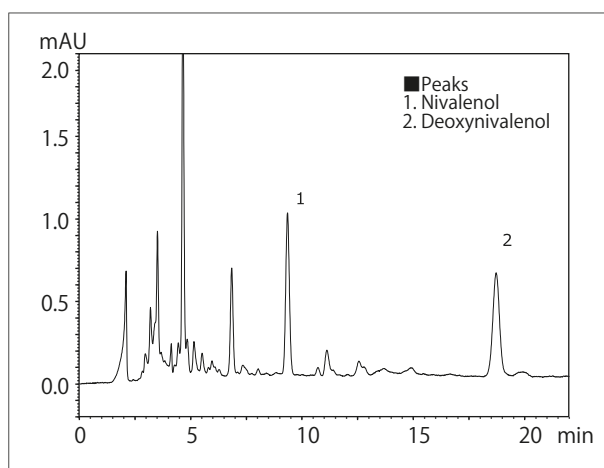

Fig. 6 Chromatogram of Wheat B (Spiked with 1.0 ppm each) (Autoprep MF-T)

# Application News

## No.L481

### High Performance Liquid Chromatography

## Analysis of Sugars and Sugar Alcohols in Energy Drink by Prominence-i with Differential Refractive Index Detector

Sugars and sugar alcohols display almost no ultraviolet absorption, and are therefore typically detected using a differential refractive index detector or evaporative light scattering detector. By using a ligand exchange column for sugar analysis, it is possible to distinguish among the different isomers based on the position of the hydroxyl group in the chair conformation of glucose and fructose for example. In other words, the hydroxyl group of the sugar and the metal ion of the stationary phase form a complex, making it possible to achieve separation due to the difference in the strength of the complex formation. Also, maintaining a column temperature of 80 °C suppresses sugar anomer separation and peak dispersion, thereby achieving good separation of adjacent peaks.

The new Prominence-i integrated high-performance liquid chromatograph can be connected to the RID-20A differential refractive index detector. The column oven, which can accommodate a 30 cm column and maintain temperature control up to 85 °C, therefore supports applications that require a long column.

In Application News No. 467, we introduced an example of analysis of sugars in juice, in which the Prominence-i was connected to a differential refractive index detector. Here, we introduce an example of simultaneous analysis of sugars and sugar alcohols in an energy drink using the Prominence-i and RID-20A.

### ■ Analysis of a Standard Mixture of Six Sugars

Sorbitol, xylitol, mannitol and erythritol are a type of sugar alcohol that because of their relative sweetness, are used as sweeteners. When conducting simultaneous analysis of sugars and sugar alcohols, a hydrophilic compound analytical column, such as the SPR-Ca or SPR-Pb, is suitable along with the use of a combination of the size exclusion and ligand exchange modes of analysis. Fig. 1 shows the results of analysis of a standard solution of six sugar alcohol substances (10 g/L each of maltose, glucose, fructose, erythritol, mannitol and sorbitol) using the SPR-Ca column with a 10 µL injection. The analytical conditions are shown in Table 1.

Fig. 2 shows the results of analysis of a standard solution of six sugar substances including sugar alcohols (10 g/L each of maltose, glucose, fructose, mannitol, xylitol, sorbitol) using a 10 µL injection, and Table 2 shows the analytical conditions that were used. The SPR-Pb was used as the analytical column.

**Table 1 Analytical Conditions**

Column	: Shim-pack SPR-Ca (250 mm L × 7.8 mm I.D., 8 µm)
Mobile Phase	: Water
Flowrate	: 0.6 mL/min
Column Temp.	: 80 °C
Injection Volume	: 10 µL
Detection	: RID-20A
	Polarity +, Cell temp. 40 °C, Response 1.5 sec

**Table 2 Analytical Conditions**

Column	: Shim-pack SPR-Pb (250 mm L × 7.8 mm I.D., 8 µm)
Mobile Phase	: Water
Flowrate	: 0.6 mL/min
Column Temp.	: 80 °C
Injection Volume	: 10 µL
Detection	: RID-20A
	Polarity +, Cell temp. 40 °C, Response 1.5 sec

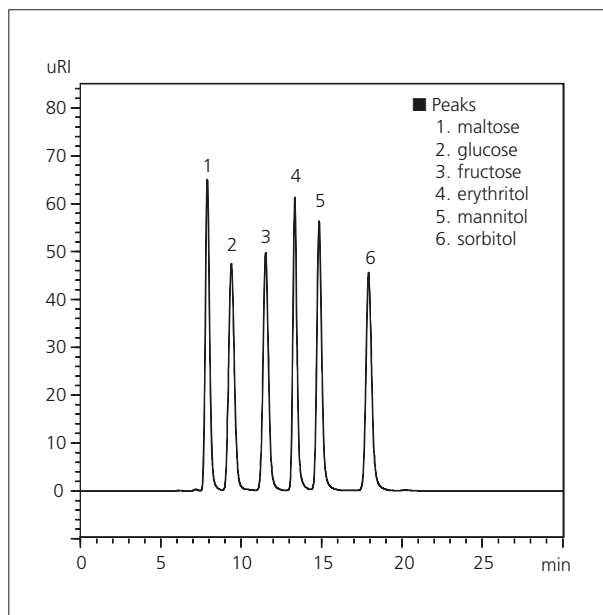

**Fig. 1 Chromatogram of a Standard Mixture of Six Sugars (10 g/L each, 10 µL Injected)**

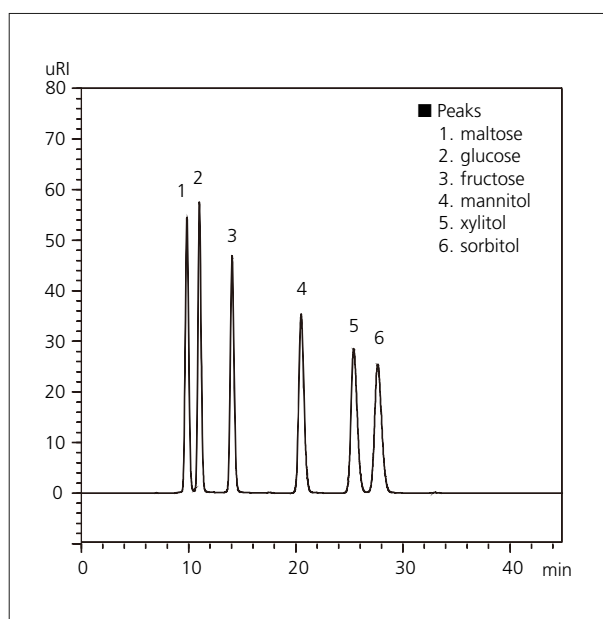

**Fig. 2 Chromatogram of a Standard Mixture of Six Sugars (10 g/L each, 10 µL Injected)**

■ **Linearity**

Fig. 3 shows the calibration curves generated using the analytical conditions of Table 2. When generating the curves for the six components over a concentration range of 0.2 to 10 g/L (using the average of three area values, respectively), excellent linearity with a coefficient of determination greater than  $R^2=0.9999$  was obtained for each component.

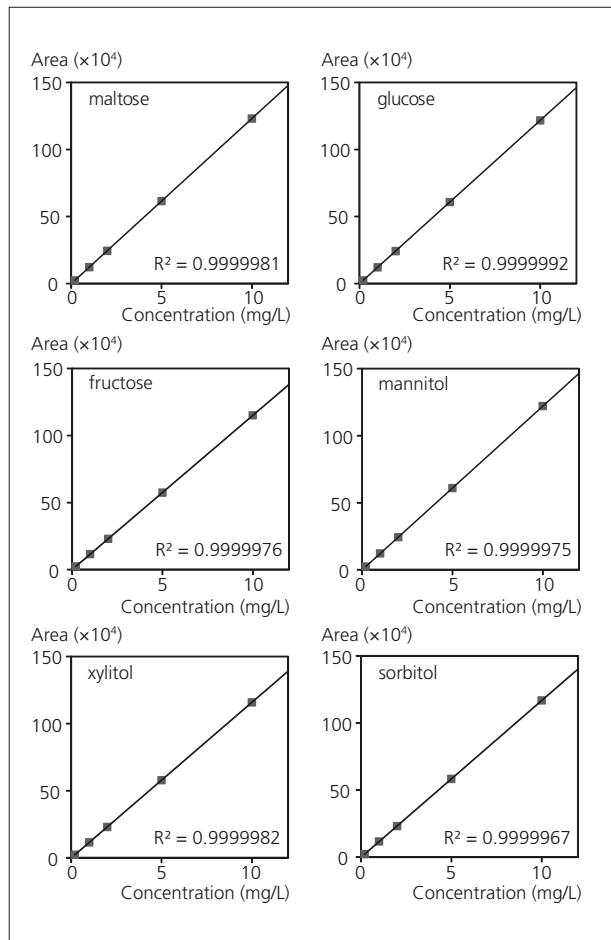

**Fig. 3 Calibration Curves of a Standard Mixture of Six Sugars (0.2 – 10 g/L, 10  $\mu$ L Injected)**

■ **Analysis of Energy Drink**

Figs. 4 and 5 show the chromatograms obtained from measurement of energy drinks A and B, respectively. Energy drink A was diluted 10:1 with water, and energy drink B, 20:1 with water, and after each was filtered through a 0.2  $\mu$ m membrane filter, 10  $\mu$ L of each sample was injected. The analytical conditions were the same as those of Table 2.

Xylitol and sorbitol were detected in energy drink A, and glucose and fructose were detected in energy drink B. Table 3 shows the quantities of each of these sugars in the respective energy drinks.

**Table 3 Content of Respective Sugars in Energy Drinks**

	Content (g/L)	
	Energy Drink A	Energy Drink B
Glucose	ND	59
Fructose	ND	101
Xylitol	25	ND
Sorbitol	14	ND

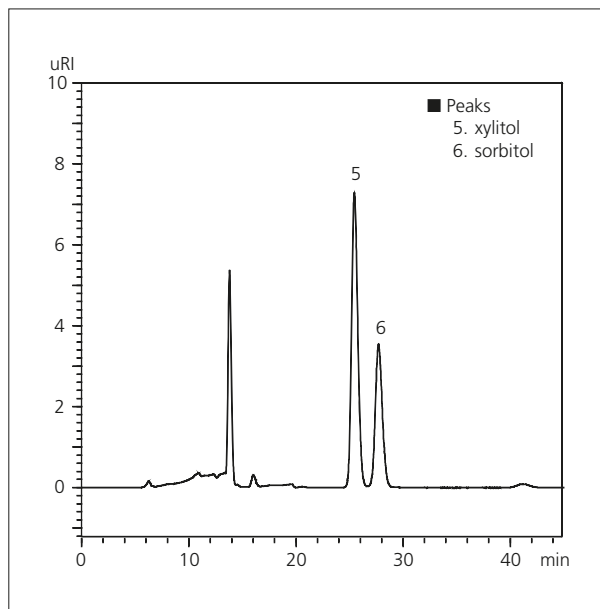

**Fig. 4 Chromatogram of Energy Drink A (10  $\mu$ L Injected)**

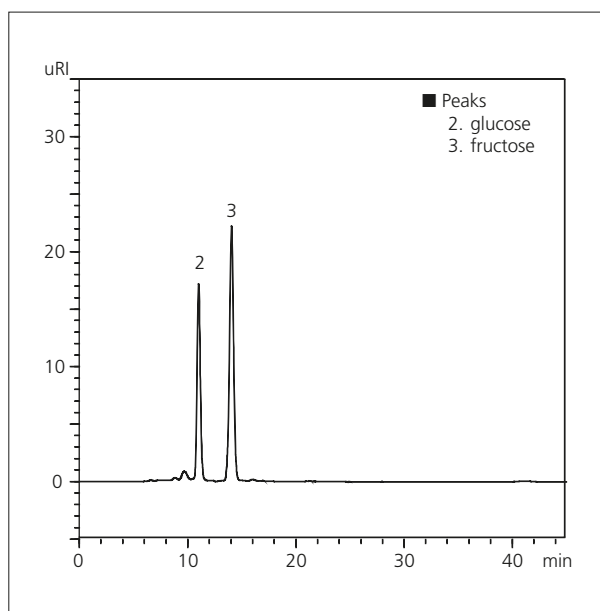

**Fig. 5 Chromatogram of Energy Drink B (10  $\mu$ L Injected)**

## Application News

No. SCA\_190\_025

Alban Huteau, Shimadzu France SAS.

### Introduction

Phenoxyethanol, Sorbic acid, Sodium dehydroacetate are used in many applications such as cosmetics, food and pharmaceuticals as a preservative.

Sorbic acid and its salts, such as sodium sorbate, potassium sorbate, and calcium sorbate, are antimicrobial agents often used as preservatives in food and drinks to prevent the growth of mold, yeast, and fungi.

High Performance Liquid Chromatography

## Analysis of Phenoxyethanol, Sorbic acid and Sodium dehydroacetate

### Analytical Conditions:

System configuration:

A Shimadzu Prominence HPLC system was used consisting of a quaternary solvent pumps (LC-20AD) with 3 channel degassers (DGU-20A3R), an autosampler (SIL-20AC), and a column oven (CTO-20AC). The system was also equipped with an SPD-M20A photo diode array detector..

Analytical Method:

Column: Purosper® STAR RP-18e,  
125 x 4.0 mm 5 µm with  
precolumn  
Mobile Phase: A: H<sub>2</sub>O + 1% Acetic Acid;  
B: ACN  
Gradient: 20 % B  
Flow rate: 1.0 mL/min  
Temperature: 35 °C  
Injection Volume: 20 µL  
Detector: SPD-M20A, semi-micro cell,  
sampling rate 40 Hz, time  
constant 0.025 sec, slit width 8 nm



## Chromatogram

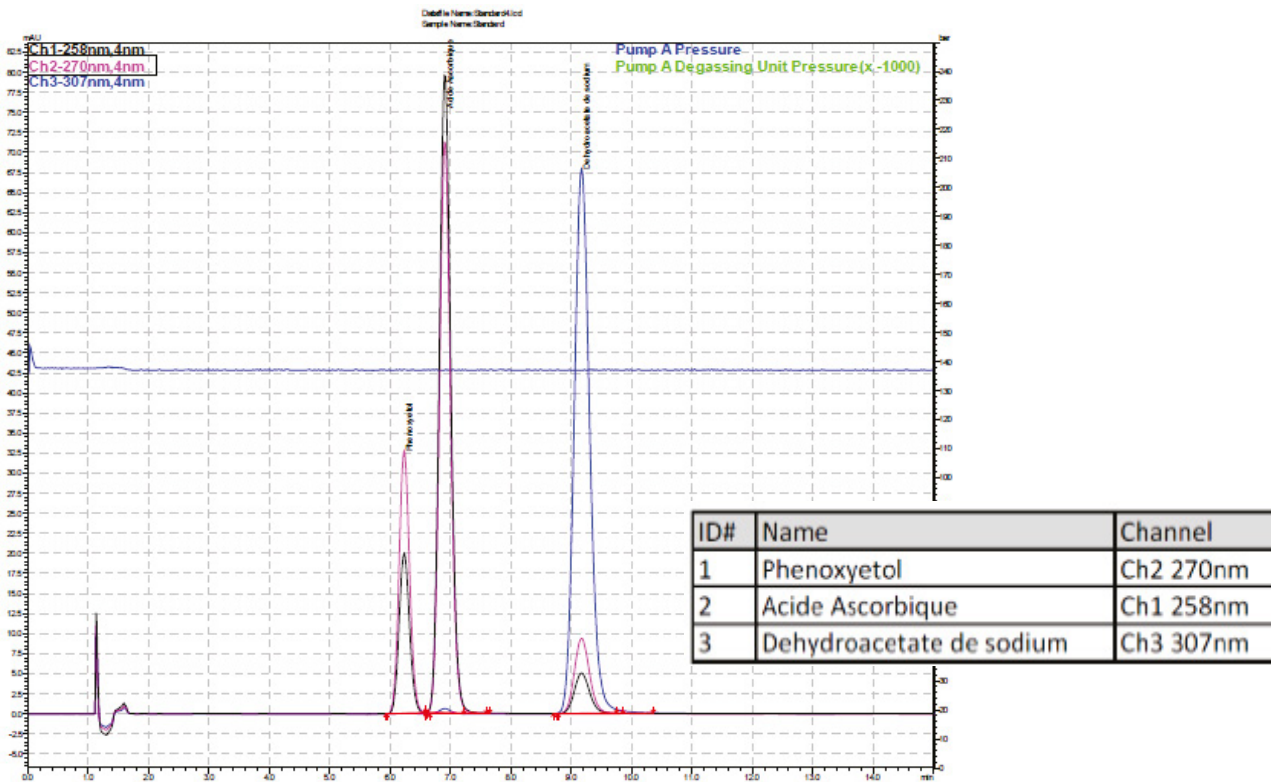

## Conclusion /Result

A fast, selective, and sensitive method for the analysis of Phenoxetyl, Sorbic acid and Sodium dehydroacetate was developed. Very good results were also obtained in deviation and accuracy and for the calibration curve a correlation coefficient from >0.999 was achieved.

# Application News

## No.L463

### High Performance Liquid Chromatography

## Analysis of Histamine and Tyramine Using Prominence Amino Acid Analysis System

Putrefactive non-volatile amines, histamine and tyramine, are formed through decomposition of histidine and tyrosine, respectively, due to the action of microorganisms. When ingested food such as processed products and red-fleshed fish such as tuna, bonito, mackerel, etc., contain a large amount of histamine, food poisoning symptoms such as fever, hives, and palpitations may appear. There are also reported cases of food poisoning associated with fermented foods such as wine and cheese. Further, tyramine can also strengthen the toxicity of histamine, and has been reported as a causative agent in food-associated migraine.

Although there are no specific histamine-related regulations in Japan, in other countries, including the United States and the EU, Codex (International Food Standards) regulatory limits for histamine have been established for fish and fishery products. As tyramine and histamine, like amino acids, contain an amino group, fluorescence detection is possible using derivatization with ortho-phthalaldehyde (OPA). Here, we introduce an example of analysis of tyramine and histamine using the Prominence Amino Acid Analysis System, in which detection is conducted using post-column fluorescence derivatization. Mobile phase and reagent kits, which are available for this application, contain the required mobile phases and reaction reagent solution, thus eliminating the tedious preparation of mobile phase. Moreover, as sample pretreatment consists only of filtering and dilution for this application, analysis can be conducted without complicated processing.

### ■ Analysis of Standard Solution

The analytical conditions that were used are shown in Table 1, and the chromatogram obtained from analysis of a standard solution of histamine and tyramine (each at 10 mg/L) is shown in Fig. 1. The standard solution was prepared by dissolving these in pH 2.2 sodium citrate buffer solution. For the mobile phases, the mobile phase B and C of the Amino Acid Mobile Phase kits (Na type) were used, and analysis was conducted using gradient elution. Also, because the elution positions vary depending on the mobile phase pH, use of a carbon dioxide gas trap is suggested when conducting analysis.

**Table 1 Analytical Conditions**

Column	: Shim-pack Amino-Na (100 mm L. x 6.0 mm I.D.)	
Ammonia Trap	: Shim-pack ISC-30 / S0504Na (50 mm L. x 4.0 mm I.D.)	
Mobile Phase	: Amino Acid Mobile Phase Kits (Na type, Mobile Phase B and C)	
Time Program	Time (min)	B. Conc. (%)
	0	80
	15.00	65
	15.01	0
	20.00	0
	20.01	80
	25.00	Stop
Flowrate	: 0.6 mL/min	
Column Temp.	: 60 °C	
Reagent	: Amino Acid Reagent Kits	
Flowrate of Reagent	: 0.2 mL/min	
Reaction Temp.	: 60 °C	
Detection	: RF-20Axs, Ex at 350 nm, Em at 450 nm	
Injection Vol.	: 10 µL	

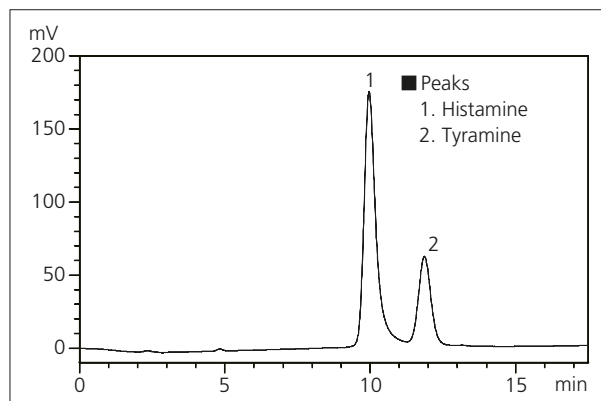

**Fig. 1 Chromatogram of Histamine and Tyramine Standard Solution (Each 10 mg/L)**

### ■ Linearity

Fig. 2 shows the linearity of histamine and tyramine using a concentration range from 0.1 mg/L to 100 mg/L. Excellent linearity was obtained with a coefficient of determination greater than  $R^2=0.9998$  for both substances.

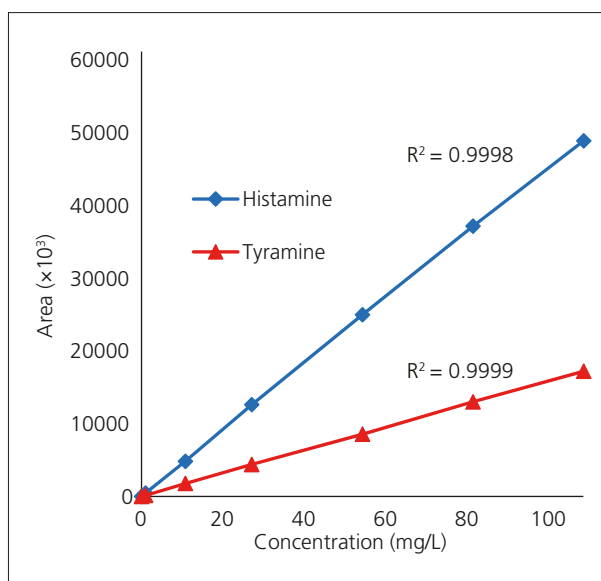

**Fig. 2 Linearity of Histamine and Tyramine (0.1 – 100 mg/L)**

■ Repeatability

Table 2 and 3 show the relative standard deviations (n=6) of retention time and peak area obtained in repeat analysis of a mixed histamine and tyramine standard solution (each 1 mg/L). Limits for histamine differ depending on the country, but in Codex, for example, the limit associated with decomposition in fish and fishery products is 100 mg/kg. Good repeatability has been obtained at a concentration of about 1/100 of the criterion.

**Table 2 Repeatability of Peak Area and Retention Time of Histamine**

	R.t (min)	Peak Area
1st	9.962	433,724
2nd	9.983	431,874
3rd	9.967	441,528
4th	9.962	429,887
5th	9.972	439,560
6th	9.993	434,818
Ave	9.973	435,232
%RSD	0.12	1.03

**Table 3 Repeatability of Peak Area and Retention Time of Tyramine**

	R.t (min)	Peak Area
1st	11.844	153,458
2nd	11.871	155,582
3rd	11.858	155,848
4th	11.855	154,509
5th	11.882	151,206
6th	11.911	153,960
Ave	11.87	154,094
%RSD	0.20	1.09

■ Analysis of Food

Figures 3 to 8 show examples of analysis of commercial fish sauce, wine, and soy sauce. Pretreatment consisted of preparing a 10-fold dilution using pH 2.2 sodium citrate buffer solution, and filtering through a 0.2 µm pore diameter membrane filter. As for the red wine and white wine, both were spiked with histamine and tyramine at 50 µg/L each.

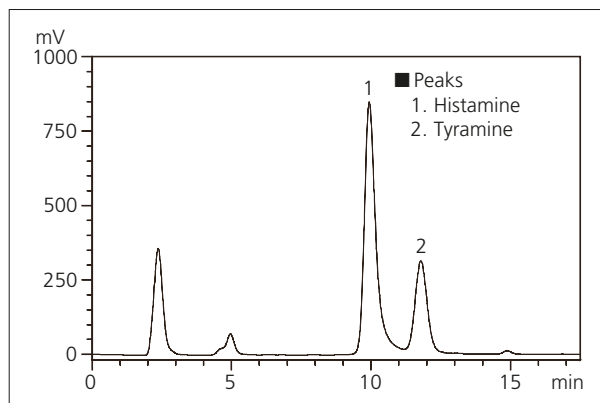

Fig. 5 Chromatogram of Red Wine

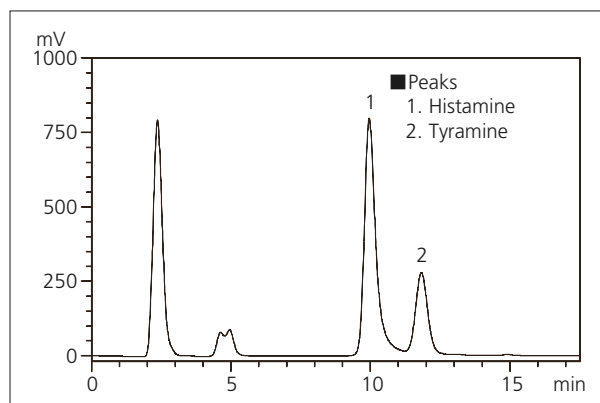

Fig. 6 Chromatogram of White Wine

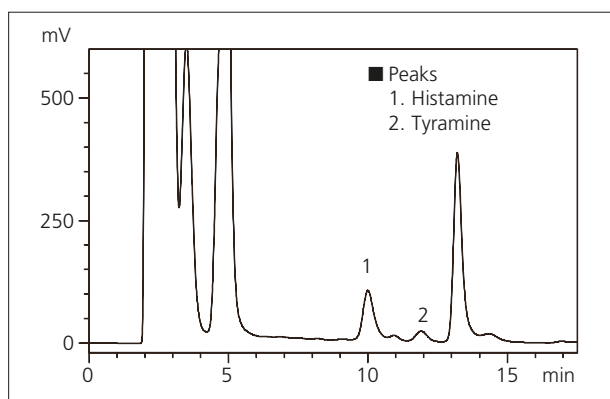

Fig. 3 Chromatogram of Fish Sauce A

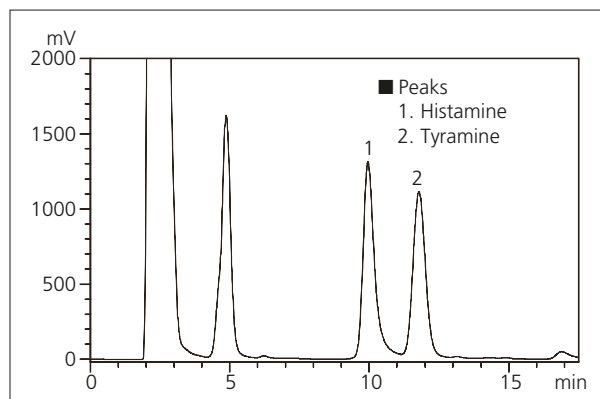

Fig. 7 Chromatogram of Soy Sauce A

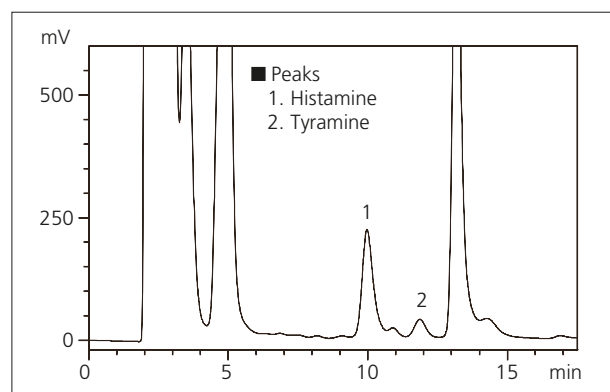

Fig. 4 Chromatogram of Fish Sauce B

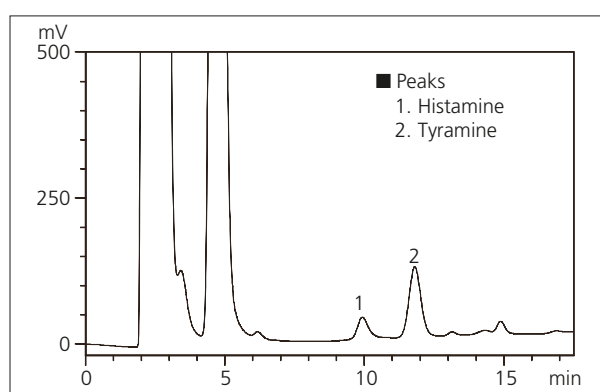
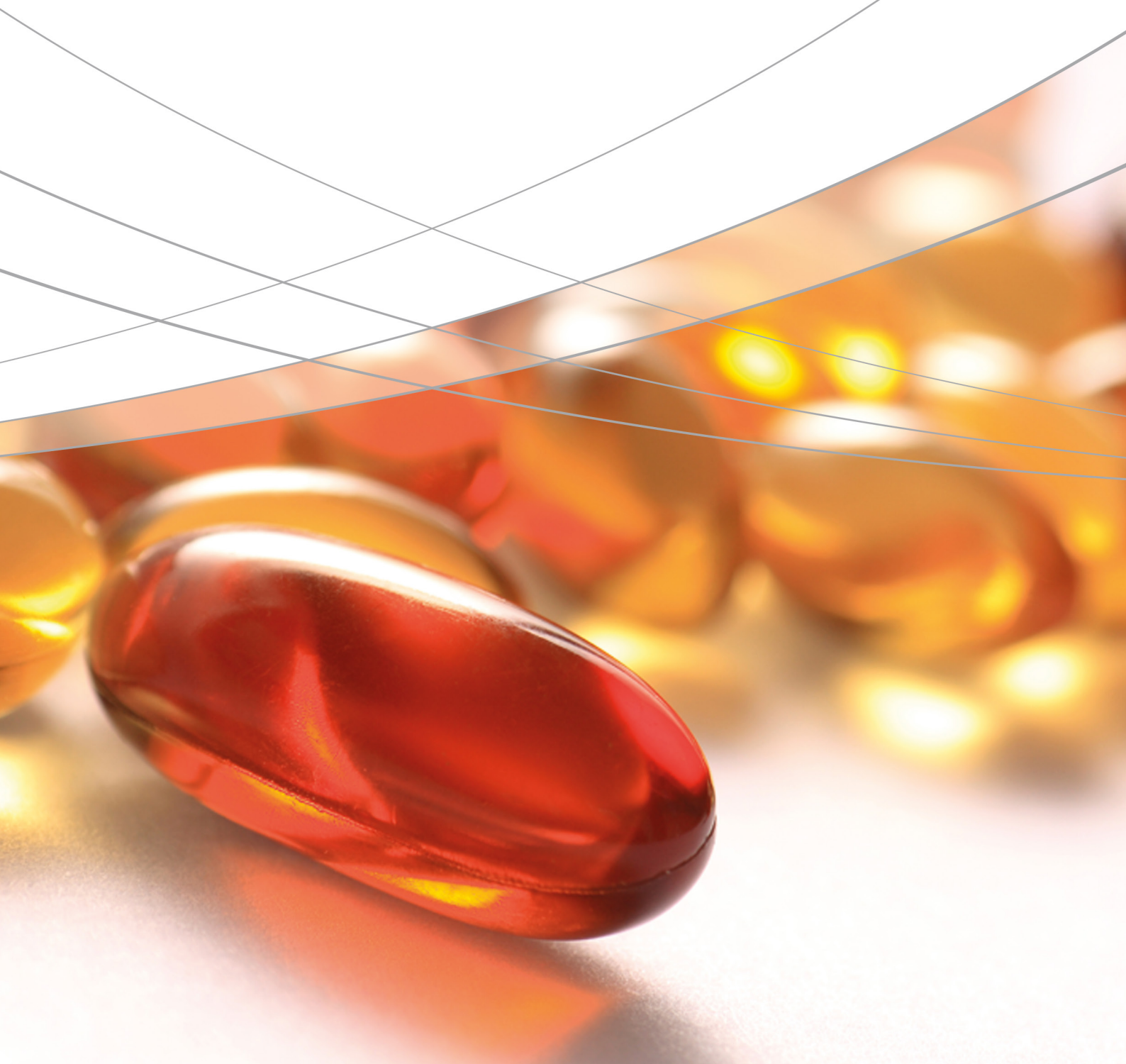

Fig. 8 Chromatogram of Soy Sauce B

# 4. Pharmaceutical







---

## 4. Pharmaceutical

---

Progress in medical and pharmaceutical technology is a key driver to increase people's life expectancy. Furthermore, research leading to advanced diagnostics, treatments and therapies assists in fighting and curing illnesses. Drugs help to overcome diseases or in case of chronic or incurable disorders, they support being able to continuously take part in social life.

Side effects from interfering substances and contaminations in drugs are undesirable. This is why it is important to use the purest possible substances and purified equipment and materials in the production of drugs. In pharmaceutical production, methods and rules for the manufacture, storage, quality and testing of drugs are standardized and defined in Pharmacopoeias.

From Drug Discovery to Quality Control, Shimadzu's wide range of solutions supports the pharmaceutical industry through chromatography (HPLC, SFC and GC), spectroscopy (UV-VIS, FTIR, AAS, ICP), mass spectrometry (LC-MS, GC-MS), sum parameter (TOC) and MALDI-TOF systems, including MS imaging. Shimadzu combines a long history in the market with a comprehensive product portfolio and expertise in regulatory compliance, making the company the perfect partner for the pharmaceutical industry.

Shimadzu's systems cover applications in

- life science research for pharmaceuticals (genomics, proteomics, metabolomics, glycomics)
- drug discovery (biomarker discovery, screening and drug synthesis)
- drug development (pre-clinical development, toxicology, pharmacology, formulation, process development)
- drug metabolism (ADME, DMPK)
- manufacturing and QA/QC (process for production, quality control and assurance)
- biopharmaceutical (protein characterization, impurity analysis for quality assurance)
- herbal medicine/natural products
- material testing (bending tests, crushing strength, dissolution time, compression tests).

Find more information on: [www.shimadzu.eu/pharmaceutical](http://www.shimadzu.eu/pharmaceutical)





---

## 4. Pharmaceutical

---

### Co-Sense for Impurities

L440 LC/MS/MS analysis of impurities in active pharmaceutical ingredients using the co-sense for impurities system

### Nexera UC SFC

L495 Automated optimization of chiral separation parameters using Nexera UC chiral screening system

### Nexera UC SFE-SFC

L499 Application of online SFE-SFC-PDA for cleaning validation

### Nexera X2-PDA

SCA\_190\_022 Analysis of amoxicillin and cefotaxime

### Nexera X2-RID

L489 Analysis of mannitol using RID-20A differential index detector

### Nexera X2-UV

L448 Ultra-high speed analysis of ibuprofen by Nexera in accordance with USP 621

### Nexera-i

L494 Analysis of omeprazole by i-Series for USP and JP methods

### Prominence-i

L466 Analysis of impurities in new-generation antidepressants by Prominence-i

L478 High-speed analysis of impurities of pramipexole dihydrochloride by Prominence-i

### Prominence-UV

L456 Ion analysis in drugs (part 3) determination of counterions (cations) by ion chromatography

L457 Ion analysis in drugs (part 4) determination of counterions (anions) by ion chromatography

L504 Analysis of ions in drugs (part 5) analysis of organic acid counterions by ion exclusion chromatography

# Application News

## No.L440

### High Performance Liquid Chromatography

## LC/MS/MS Analysis of Impurities in Active Pharmaceutical Ingredients Using the Co-Sense for Impurities System

Detection of impurities in active pharmaceutical ingredients (APIs) is often conducted using an HPLC-UV method. However, qualitative and quantitative analysis of impurities requires not only the separation of the impurities from the major component, but also separation among impurities themselves. The time and effort required to establish effective analytical conditions for this type of analysis are significant. Furthermore, the source of the impurity, whether it be the sample itself or some external factor associated with a particular lot, must also be determined. Here we demonstrate analysis of an impurity in an API using the 2-dimensional LC/MS/MS separation feature of the Co-Sense for Impurities System.

### ■ LC/MS Analysis of an Impurity Peak

Here we conducted measurement of a sample solution of rabeprazole sodium (1 mg/mL) according to the method specified in the Japanese Pharmacopeia. The analytical conditions are shown in Table 1. The Co-Sense for Impurities system with the configuration shown in Fig. 1 was used, and analysis was conducted using the red-colored segment of the flow line. The LC-UV chromatogram is shown in Fig. 2.

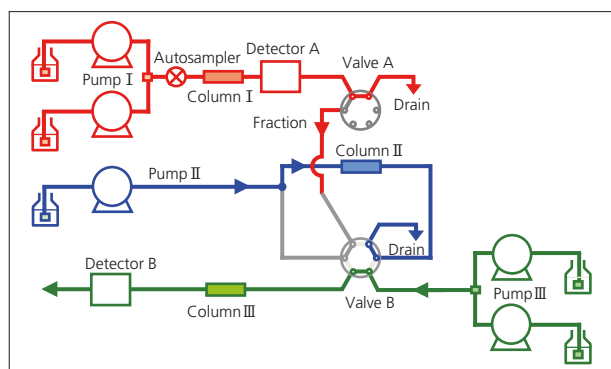

Fig. 1 Flow Diagram

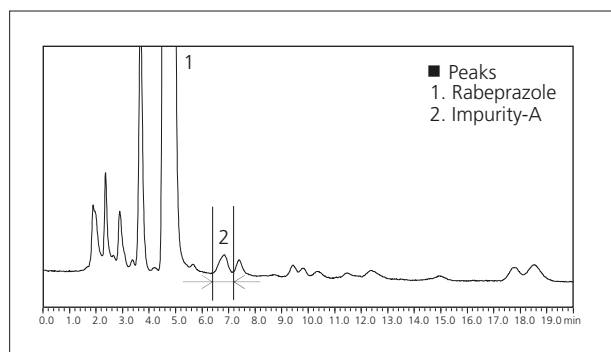

Fig. 2 LC-UV Chromatogram of Rabeprazole Sodium

Table 1 Analytical Conditions

Column (I)	: Shim-pack VP-ODS (150 mm L. × 4.6 mm I.D., 4.6 μm)
Mobile Phase	: Methanol / 50 mmol/L Phosphate buffer pH7.0 (3/2)
Flowrate	: 1.0 mL/min
Column Temp.	: 30 °C
Injection Volume	: 20 μL
Detection (A)	: UV 290 nm

MS detection requires analysis to be conducted using a volatile mobile phase. Flow lines with volatile additives in Fig. 1 are shown in blue (trap) and green (2<sup>nd</sup> separation).

In the analysis, valve A of Fig. 1 is switched during the elution of the impurity peak from the red flow line. The impurity peak is introduced into the blue-colored flow line, where it is mixed with volatile mobile phase and concentrated on column (II). Then, valve B is switched for elution and separation on column (III) with volatile mobile phase in the green flow line. The analytical conditions for that process are shown in Table 2.

Table 2 Analytical Conditions

Column (II)	: STR-ODS II (10 mm L. × 4.6 mm I.D., 5 μm)
Mobile Phase	: 100 mmol/L Ammonium Acetate
Flowrate	: 5.0 mL/min
Column (III)	: Shim-pack XR-ODS (50 mm L. × 2.0 mm I.D., 2.2 μm)
Mobile Phase	: Methanol / 10 mmol/L Ammonium Acetate (3/2)
Flowrate	: 0.2 mL/min
Detection (B)	: LCMS-8030 (ESI)

We conducted MS measurement in scan mode of impurity peak A (peak area approximately 0.06 % of the API peak) with an approximate retention time of 6.8 minutes as shown in Fig. 2, and the mass chromatograms of  $m/z$  394.1,  $m/z$  508.2 and  $m/z$  569.2 using electrospray ionization in positive mode are shown in Fig. 3. These peaks showed nearly identical elution patterns when using direct LC/MS analysis of the sample solution. However, using the 2-dimensional enhanced separation, three impurity peaks (IM1 – IM3) were all separately distinguishable.

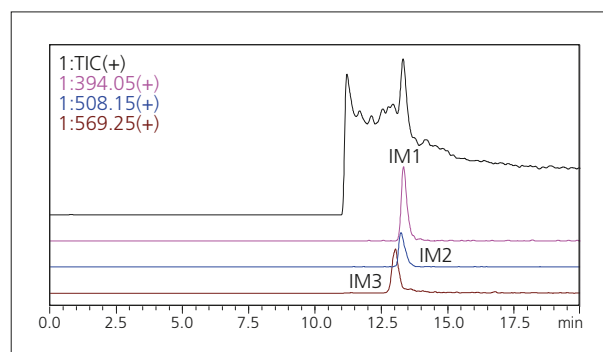

Fig. 3 Mass Chromatograms of Impurity-A Peak

### Structure Prediction and MRM Analysis of Impurities

After conducting a product ion scan of the precursor ion at  $m/z$  508.2, we predicted the structure of the impurity IM2 through comparison with the API. Fig. 4 shows the obtained product ion spectrum. These results indicate that the impurity is a benzimidazol-2-thiol derivative of the API.

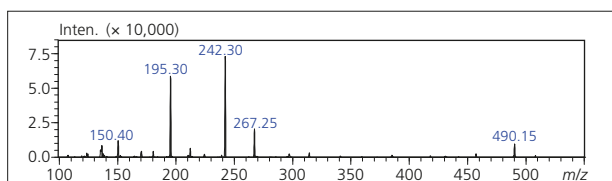
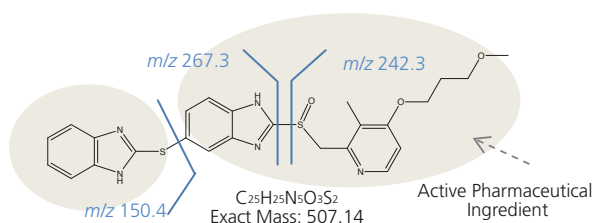

Fig. 4 Product Ion Spectrum for  $m/z$  508.2



In addition, MRM measurements were conducted for the impurities IM1 – IM3. Using this method, we achieved excellent repeatability by conducting replicate measurements of the sample solution, in addition to excellent linearity with different sample injection volumes.

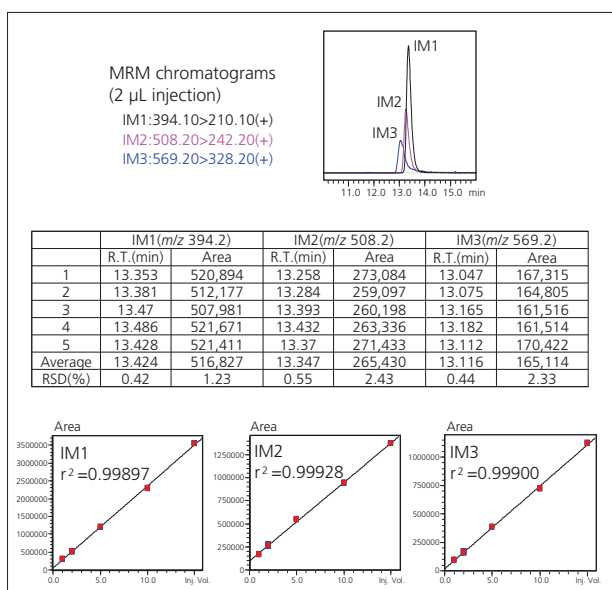

Fig. 5 MRM Analysis of Impurities IM1 - IM3

### 2-Dimensional Separation of Impurity Peak

Using this LC/MS/MS system, we conducted an in-depth examination of the separation obtained using UV detection of impurity peak A (Peak 2 of Fig. 6), which we confirmed to have eluted simultaneously as three separate impurity components.

As a result, by replacing mobile phase A in the second dimension from the aqueous solution of ammonium acetate (chromatogram (2), Fig. 6) to aqueous acetic acid (chromatogram (1), Fig. 6), the impurity separation was improved.

In addition, Fig. 6 shows the LC-UV chromatograms in which all the vertical axes have been normalized. Compared to the original impurity peak A obtained from just the first separation alone, shown at left, the peak intensity is much greater when using the second separation. These results indicate that both separation and sensitivity can be improved using the Co-Sense for Impurities System.

Table 3 Analytical Conditions

Column (II)	: STR-ODSII (10 mm L. × 4.6 mm I.D., 5 µm)
Mobile Phase	: 10 mmol/L Ammonium Acetate
Flowrate	: 5.0 mL/min
Column (III)	: Shim-pack XR-ODS (50 mm L. × 2.0 mm I.D., 2.2 µm)
Mobile Phase	: A; (1) 0.1 % Acetic acid aq. B; Methanol
Time Program	: B CONC 40 % (0 min) → 65 % (5 min) · Mixer : 180 µL
Flowrate	: 0.2 mL/min
Detection (B)	: UV 290 nm

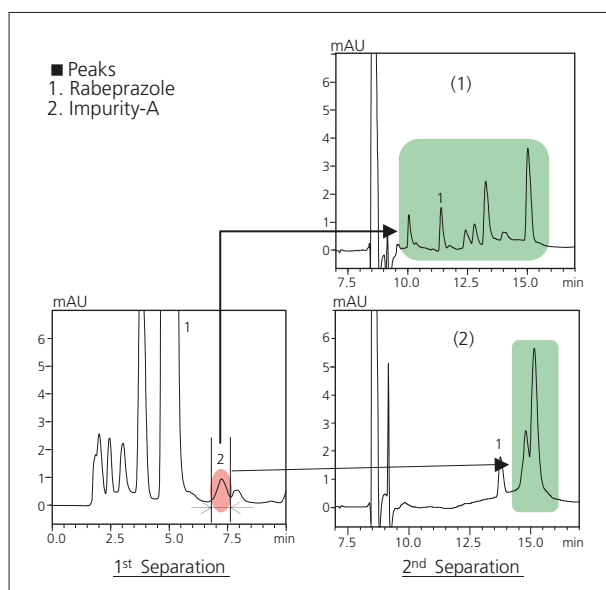

Fig. 6 2-Dimensional Separation of Impurity-A Peak

# Application News

## No.L495

### Supercritical Fluid Chromatography

## Automated Optimization of Chiral Separation Parameters Using Nexera UC Chiral Screening System

Chiral compounds contain asymmetric carbons in their molecules and are not superimposable on their mirror images. HPLC has been the main method used to separate such chiral compounds, but in recent years, the use of supercritical fluid chromatography (SFC) has been gaining attention. The main mobile phase used for chiral SFC is supercritical carbon dioxide, with low polarity, low viscosity, and high diffusivity, to which polar organic solvents (modifiers) are added to control solubility and polarity. Therefore, chiral compound separation by HPLC, which generally uses normal phase conditions, offers the potential for high speed, low organic solvent consumption, low cost, and low environmental impact. However, chiral SFC requires selecting a variety of separation parameters, such as columns and modifiers, which can involve large amounts of time and effort. This article describes using the Nexera UC chiral screening system to automatically optimize the large number of separation parameters by switching between up to 12 columns and various mixture ratios of four types of modifiers. This can significantly reduce the effort required.

### ■ Separation Parameters for the Chiral Screening System

Model sample: The structure of omeprazole is shown in Fig. 1. Daicel CHIRALPAK®/CHIRALCEL® series 12 columns for chiral analysis were used for the analysis. These columns offer a line of complementary stationary phase columns that are able to separate a wide variety of chiral compounds. When used in combination with the Nexera UC chiral screening system, which features a method scouting function, optimal chiral separation parameters can be determined easily. In addition, three types of modifiers were used, methanol, ethanol, and a mixture of acetonitrile and ethanol. Details about the separation parameters are indicated in Table 1. The optimal parameters for chiral separation were comprehensively selected from the total of 36 possible combinations of modifiers (3 types) and columns (12 types).

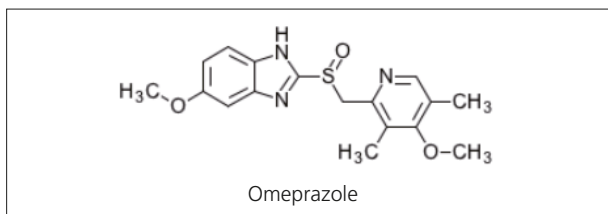

Fig. 1 Sample Used to Evaluate the Method Scouting Function

Table 1 Analytical Conditions

Column	: CHIRALPAK®, CHIRALCEL® Series 100 mm L. × 3.0 mm I.D., 3 μm
Mobile Phase	: A; Super critical fluid of CO <sub>2</sub> B; Modifier: Methanol, Ethanol, mixture of Acetonitrile: Ethanol = 3:1 (v:v)
Time Program	: B Conc. 20 % (0 - 8 min) → 40 % (8 - 10 min) → 20 % (10 - 14 min)
Flowrate	: 3 mL/min
Column Temp.	: 40 °C
Injection Volume	: 2 μL
BPR Pressure	: 10 Mpa
Detector	: Photodiode Array Detector (Max Plot 210 - 400 nm)

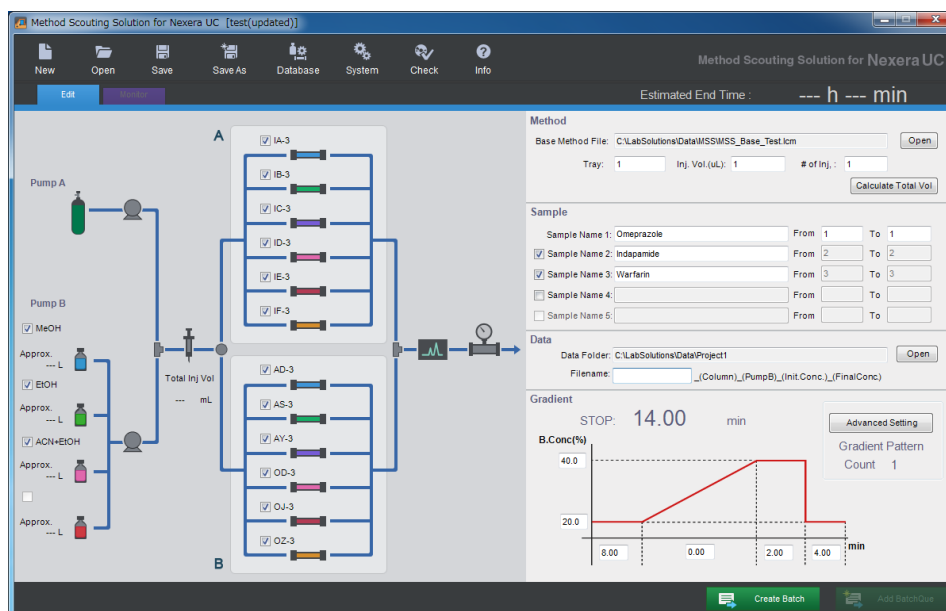

Fig. 2 Method Scouting Solution Operating Screen for Nexera UC

### Automated Optimization of Chiral Separation Parameters for Omeprazole

Fig. 3 shows the results from a total of 36 possible combinations of 12 chiral columns and 3 types of modifiers (methanol, ethanol, and acetonitrile/ethanol mixture).

For omeprazole, separation of peaks for two chiral forms were confirmed within 8 minutes of retention. Fig. 4 shows the separation evaluation and optimal parameter

ranking results from the optional software. The software automatically ranks all the chromatograms with separation greater than a given criteria (in this case, 1.5). This confirmed the utility of using the Nexera UC chiral screening system to automatically optimize separation parameters for chiral SFC, which otherwise requires a complicated process of selecting analytical conditions.

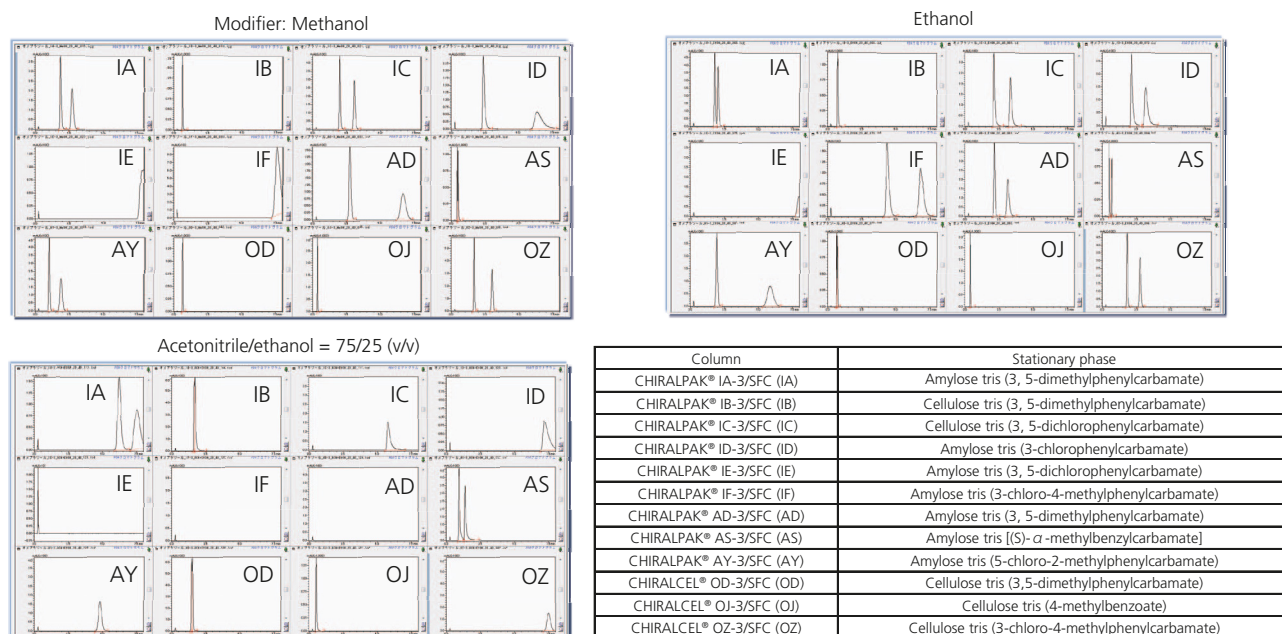

Fig. 3 Comparison of Separation Using Different Combinations of 12 Chiral Columns and 3 Modifiers

Ranking	Run No.	Analytical Condition	Resolution	Separation factor	Symmetry factor		Retention factor		Area%		Peak number
					Peak1	Peak2	Peak1	Peak2	Peak1	Peak2	
1	32	Omeprazole_OZ-3_MeOH_20_40	7.965	1.921	1.16	1.159	6.583	12.644	49.829	50.171	2
2	17	Omeprazole_IC-3_MeOH_20_40	5.587	1.602	1.387	1.274	8.078	12.937	49.971	50.029	2
3	16	Omeprazole_IC-3_EtOH_20_40	5.382	1.639	1.915	1.661	8.617	14.124	49.984	50.016	2
4	31	Omeprazole_OZ-3_EtOH_20_40	5.377	1.599	1.169	1.162	7.229	11.561	49.778	50.222	2
5	1	Omeprazole_AD-3_EtOH_20_40	3.996	1.509	1.257	1.404	8.779	13.25	50.054	49.946	2
6	8	Omeprazole_AY-3_MeOH_20_40	3.55	2.08	1.178	1.145	3.652	7.597	49.974	50.026	2
7	11	Omeprazole_IA-3_MeOH_20_40	3.428	1.523	1.464	1.312	7.435	11.327	49.973	50.027	2
8	4	Omeprazole_AS-3_EtOH_20_40	2.515	1.673	1.657	1.518	1.244	2.081	49.754	50.246	2
9	10	Omeprazole_IA-3_EtOH_20_40	1.586	1.157	1.322	1.279	7.115	8.234	49.347	50.653	2

Separation Parameters for Rank 1  
Column: CHIRALCEL® OZ-3/SFC  
Modifier: Methanol

Separation Parameters for Rank 2  
Column: CHIRALPAK® IC/SFC  
Modifier: Methanol

Separation Parameters for Rank 3  
Column: CHIRALPAK® IC/SFC  
Modifier: Ethanol

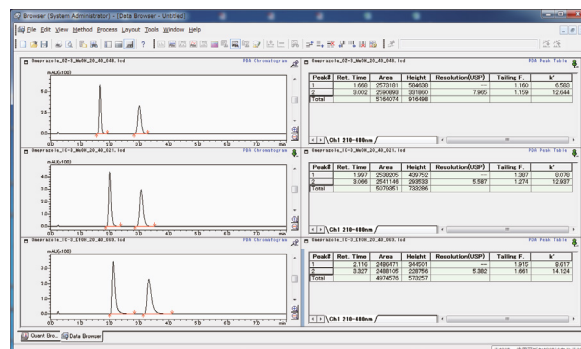

Fig. 4 Evaluation of Separation Parameters and Chiral Separation Chromatogram Using Optimized Parameters

\* CHIRALPAK® and CHIRALCEL® are registered trademarks of Daicel Corporation.



# Application News

## No. L499

Supercritical Fluid Extraction / Chromatography

### Application of Online SFE-SFC-PDA for Cleaning Validation

Cleaning validation is a process step that is extremely important for ensuring high quality and safety at pharmaceutical manufacturing sites. Cloth used for surface wiping, called a swab, is used to wipe a given part of a piece of manufacturing equipment, and analysis of the wiped area of the swab is performed by using high-performance liquid chromatography (HPLC) or a total organic carbon analysis (TOC). Evaluations using HPLC have been increasingly used in recent years because HPLC enables determination of individual compounds. Prior to analysis, an extraction procedure must be performed on the swab. Using supercritical fluid extraction (SFE) as the pretreatment method allows for simple and quick target component extraction. Using supercritical fluid chromatography (SFC) after SFE also means that analysis results can be obtained simply by preparing the sample for SFE, which unifies the work flow from pretreatment to analysis. Please see Application News L496 for an overview of online SFE-SFC. This article describes the process of column selection using the Nexera-UC Chiral Screening System as the first step in analysis of the target compound alkylbenzenesulfonate.

#### ■ Analytical Column Selection

For SFC analysis, selection of the optimal column for the sample has a substantial effect on analysis reliability. We performed SFC separation of alkylbenzenesulfonate in four different columns under the conditions shown in Table 1 and Fig. 1, and chose the Shim-pack UCX-SIL analytical column as it had the best peak shape. Based on an investigation of gradient profiles, we also found a relatively steep gradient profile is suitable for quantitative analysis as the properties of alkylbenzenesulfonate, which have different length of carbon chains, mean the significant peak broadening if the gradient slope is not steep. Based on this information, we optimized analytical conditions using the Shim-pack USX-SIL column and performed online SFE-SFC analysis of a sample from a swab.

**Table 1 SFC Analytical Conditions for Column Selection**

Column	: Shim-pack UCX series columns (250 mm L. x 4.6 mm I.D., 5 μm) (i) UCX-RP (ODS with polar group), (ii) UCX-GIS (ODS), (iii) UCX-SIL, (iv) UCX-DIOL
Mobile Phase	: A: CO <sub>2</sub> ; B: Methanol
Time Program	: Shown in the figure
Flowrate	: 3.0 mL/min
Column Temp.	: 40 °C
Back Pressure	: 15 MPa
Wavelength	: 220 nm
Injection Vol.	: Shown in figure

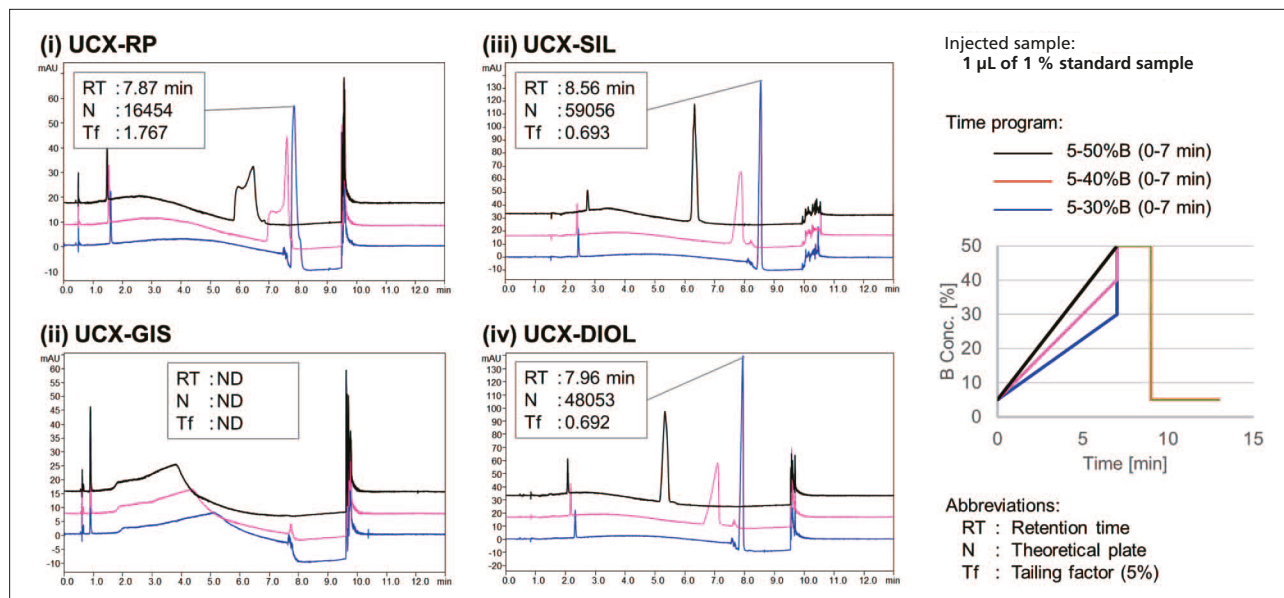

**Fig. 1 Comparison of SFC Separation of Standard Alkylbenzenesulfonate in Four Different Columns**

### ■ Online SFE-SFC Analysis of a Swab Containing Alkylbenzenesulfonate

We investigated column selection by the scouting system, chose the Shim-pack UCX-SIL analytical column, optimized each analytical condition for online SFE-SFC analysis, then performed analysis using the conditions shown in Table 2 below.

**Table 2 Analytical Conditions for Online SFE-SFC**

<b>[Sample Preparation]</b>	
A total of 10 to 500 µg standard samples in methanol were dropped onto swabs.	
The swabs were enclosed into an extraction vessel and set to the SFE unit.	
<b>[Static Extraction]</b>	
Extraction Time : 3 min	
Mobile Phase	: A: CO <sub>2</sub> ; B: 0.1 % (w/v) Ammonium Formate in Methanol
B Conc.	: 10 %
Flowrate	: 3.0 mL/min
Back Pressure	: 15 MPa
<b>[Dynamic Extraction]</b>	
Extraction Time : 3 min	
Mobile Phase	: A: CO <sub>2</sub> ; B: Methanol
B Conc.	: 10 %
Flowrate	: 3.0 mL/min
Back Pressure	: 15 MPa
<b>[SFC]</b>	
Column	: Shim-pack UCX-SIL (250 mm L. × 4.6 mm I.D., 5 µm)
Mobile Phase	: A: CO <sub>2</sub> ; B: Methanol
Time Program	: 10 %B (0-2 min), 10-60 %B (2-7 min), 60 %B (7-9 min), 10 %B (9-13 min)
Flowrate	: 3.0 mL/min
Column Temp.	: 40 °C
Back Pressure	: 15 MPa
Wavelength	: 220 nm

The peak for the surfactant alkylbenzenesulfonate was well-separated and detected as shown in Fig. 2 below. Fig. 3 shows the results of performing repeated SFE-SFC analyses from the same swab to which had been added an equivalent of 100 ng of alkylbenzenesulfonate. Since there was almost no alkylbenzenesulfonate peak evident from the second and later sample extractions, the extraction procedure was almost entirely complete after the first SFE. Fig. 4 shows the results of adding amounts of alkylbenzenesulfonate to swabs in the range of 10 to 500 µg, and checking linearity. Within this range, the coefficient of determination that represents linearity was 0.996. Fig. 5 shows the result of five consecutive analyses of separate swabs to which were added 100 µg of alkylbenzenesulfonate. Considering the process including extraction, the repeatability of retention times was 0.19 %RSD, and repeatability of peak area was 5.76 %RSD. Based on these results, we confirmed the usefulness of the Nexera-US Online SFE-SFC System in this application.

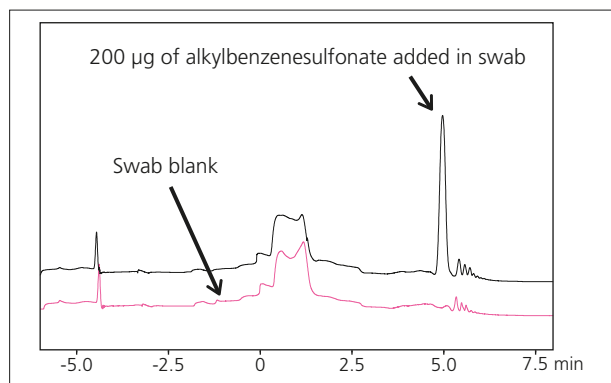

**Fig. 2 Online SFE-SFC Analysis of Alkylbenzenesulfonate**

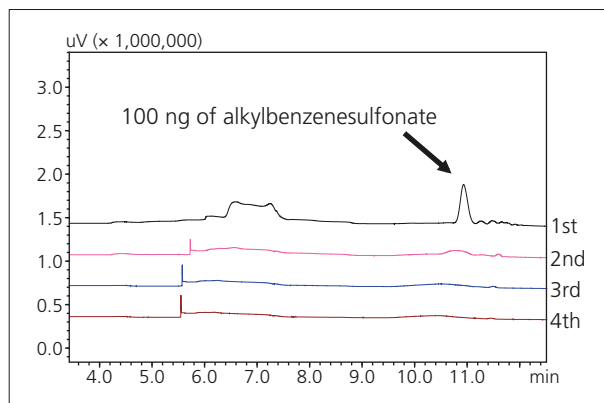

**Fig. 3 Confirmation of Online SFE Extraction Efficiency**

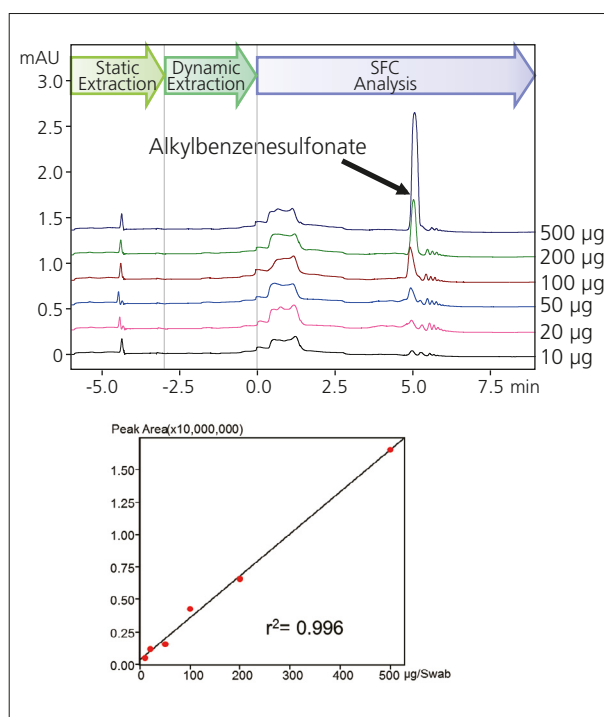

**Fig. 4 Linearity of Online SFE-SFC Analysis Using a Swab**

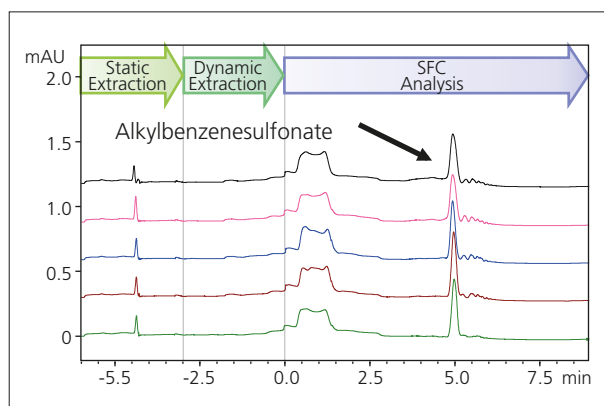

**Fig. 5 Repeatability of Online SFE-SFC Analysis Using a Swab**

Note: Swab samples were provided by Eisai Co., Ltd.

## Application News

No. SCA\_190\_022

Alban Huteau, Shimadzu France SAS.

High Performance Liquid Chromatography

### Analysis of amoxicillin and cefotaxime

#### Introduction

Amoxicillin, is an antibiotic useful for the treatment of a number of bacterial infections. It is the first line treatment for middle ear infections. It may also be used for strep throat, pneumonia, skin infections, and urinary tract infections among others. It is taken by mouth.

Cefotaxime is a third-generation cephalosporin antibiotic. Like other third-generation cephalosporins, cefotaxime is a broad-spectrum antibiotic with activity against numerous Gram-positive and Gram-negative bacteria. Developed by Hoechst-Roussel Pharmaceuticals in the late 1980s, it was among the first third-generation ("extended spectrum") cephalosporins and the first of its class to become available in the United States. It is on the World Health Organization's List of Essential Medicines, the most important medications needed in a basic health system.

#### Chromatogram

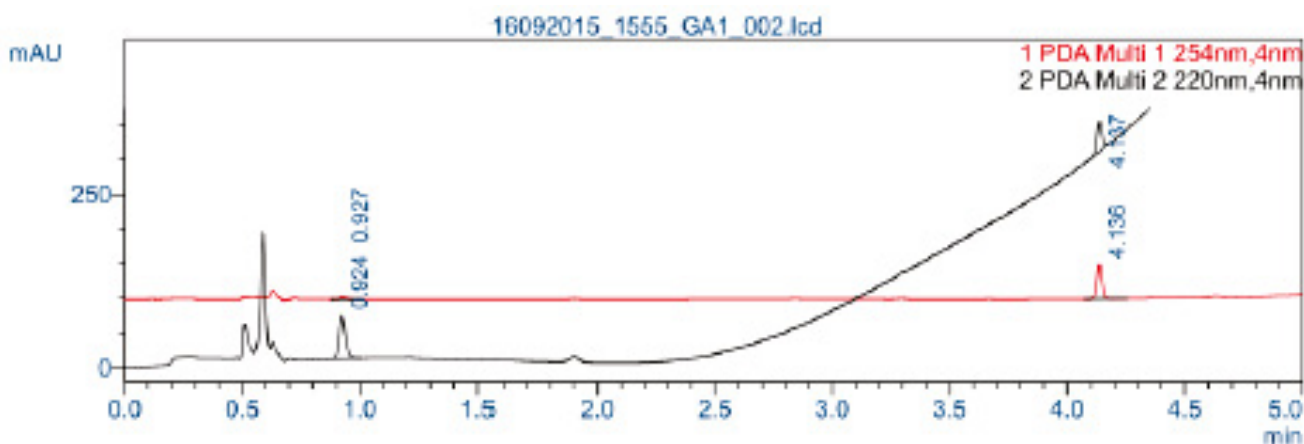

#### Conclusion /Result

A fast, selective, and sensitive method for the analysis of amoxicillin and cefotaxime was developed.

#### Analytical Conditions:

System configuration:

A Shimadzu Nexera X2 UHPLC system was used consisting of two quaternary solvent pumps (LC-30AD) with two 5 channel degassers (DGU-20A5R), an autosampler (SIL-30AC), and a column oven (CTO-20AC). The system was also equipped with an SPD-M30A photo diode array detector.

Analytical Method:

Column: Kinetex C18, 100 x 2.1 mm 2.6  $\mu$ m  
Mobile Phase: A: H<sub>2</sub>O + 2 mM CH<sub>3</sub>COONH<sub>4</sub>;  
B: MeOH + 0.1% FA  
Gradient: 10 % B (0-0.5 min); 95 % B (4-6.5 min); 10 % B (6.8-10 min)  
Flow rate: 0.4 mL/min  
Temperature: 30 °C  
Injection Volume: 0.5  $\mu$ L  
Detector: SPD-M30A, standard cell, sampling rate 12.5 Hz, time constant 0.160 sec, slit width 8 nm

Very good results were also obtained in deviation and accuracy and for the calibration curve a correlation coefficient from >0.999 was achieved.

# Application News

## No. L489

### High Performance Liquid Chromatography

## Analysis of Mannitol Using RID-20A Differential Index Detector

Mannitol possesses characteristics that include low moisture absorption and low reactivity, and is therefore used as an excipient for pharmaceuticals. USP methods for D-mannitol (hereafter, "mannitol") were amended in 2014 to specify the use of refractive index detection with a 7.8 mm × 300 mm L19 column.

The RID-20A differential refractive index detector features an optical system with dual temperature control to absorb the impact of subtle changes in temperature, thereby permitting chromatograms to be generated with a stable baseline. Here, we introduce an example of mannitol analysis using the RID-20A.

### System Suitability

Fig. 1 shows the structural formula of mannitol. The test method for mannitol specifies that two types of system suitability test standard solutions be analyzed. The upper data of Fig. 2 shows the system suitability test results for Standard Solution 1, consisting of isomalt and maltitol standards (each 1 g/L), and the lower data of Fig. 2 shows the results using Standard Solution 2, consisting of mannitol and sorbitol standards (each 25 g/L). Table 1 shows the analytical conditions.

Table 2 shows the reference values for the system suitability test, in addition to the analysis results. The results confirm that system suitability is satisfied with respect to all the criteria.

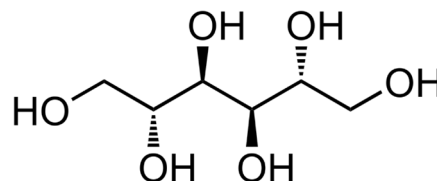

Fig. 1 Structure of D-Mannitol

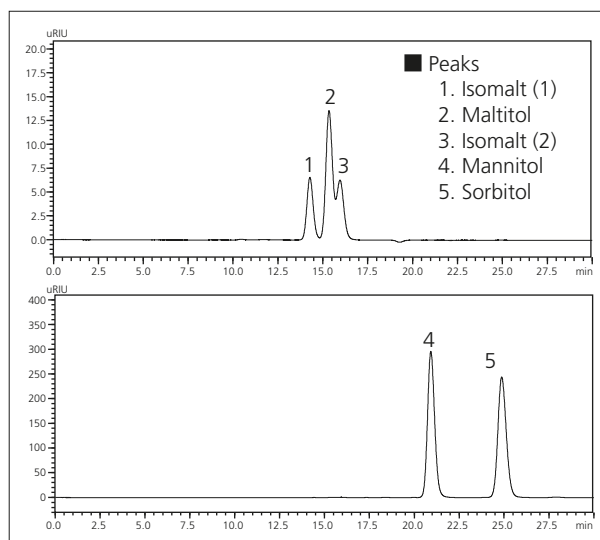

Fig. 2 Chromatograms of a Standard Mixture of Four Sugar Alcohols  
Upper: System Suitability Solution 1 (Isomalt, Maltitol)  
Lower: System Suitability Solution 2 (Mannitol, Sorbitol)

Table 1 Analytical Conditions

System	: Prominence
Column	: Shim-pack SCR-101C (300 mm L. × 7.9 mm I.D., 10 μm)
Mobile Phase	: Water
Flowrate	: 0.5 mL/min
Column Temp.	: 85 °C
Injection Volume	: 20 μL
Detection	: RID-20A

Table 2 Results of System Suitability Test

System Suitability Assessment Item	Target Substance	Reference Value	Analysis Result
Retention Time	Mannitol	Approximately 20 minutes	20.9 minutes
Relative Retention Time with Respect to Mannitol	Isomalt (1)	Approximately 0.6	0.68
	Maltitol	Approximately 0.69	0.73
	Isomalt (2)	Approximately 0.73	0.76
	Sorbitol	Approximately 0.12	1.2
Resolution	Mannitol and sorbitol	Greater than 2.0	5.0
Relative Standard Deviation of Peak Area Value	Mannitol	Less than 1.0 %	0.03 %

■ **Linearity**

Fig. 3 shows the calibration curve of mannitol analyzed using the conditions of Table 1. The correlation coefficient over the concentration range from 1 to 100 g/L is  $R^2 = 0.999$ , demonstrating excellent linearity.

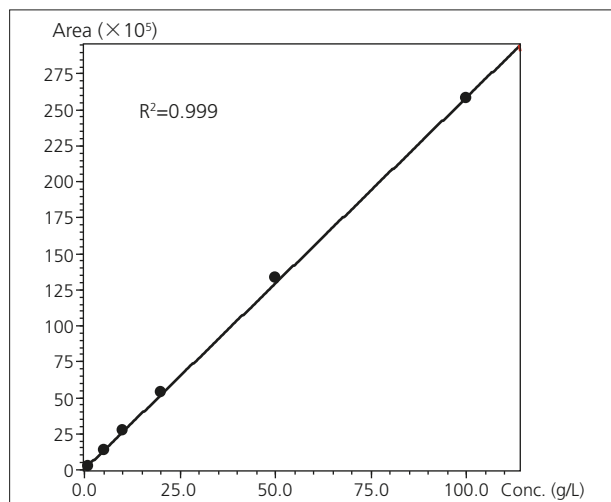

Fig. 3 Linearity of Calibration Curve

■ **Effect of Column Temperature**

Fig. 4 shows the chromatograms obtained in analysis of the four sugar alcohol standard samples using the two column oven temperatures of 85 °C and 60 °C. The upper pair of chromatograms are those of isomalt and maltitol, and the lower pair, of mannitol and sorbitol. When the column temperature is lowered to 60 °C, the retention time of mannitol becomes 23 minutes, at which point the system suitability requirement is no longer satisfied.

When analysis is conducted at a high column temperature like 85 °C, it is important that the temperature be maintained uniformly over the entire length of the column. The CTO-20AC column oven used in this analysis is equipped with forced air circulation, thereby permitting stable analysis even at high temperatures.

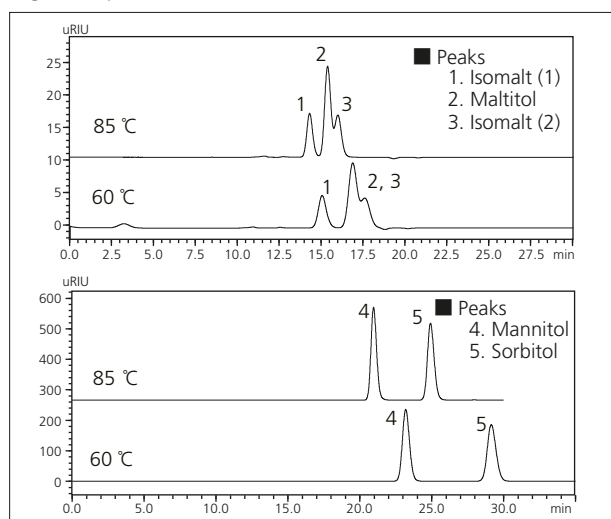

Fig. 4 Chromatograms of a Standard Mixture of Four Sugar Alcohols (85 °C, 60 °C)

■ **Analysis of a Pharmaceutical Excipient**

Fig. 5 shows an example of analysis of a pharmaceutical excipient, consisting mainly of mannitol, using a 20 µL injection of 50 g/L sample solution. The chromatogram of the excipient is shown in the upper portion of the figure, while an expanded view of the chromatogram is shown in the lower portion. Trace levels of other substances, including sorbitol and isomalt, were also detected in the excipient.

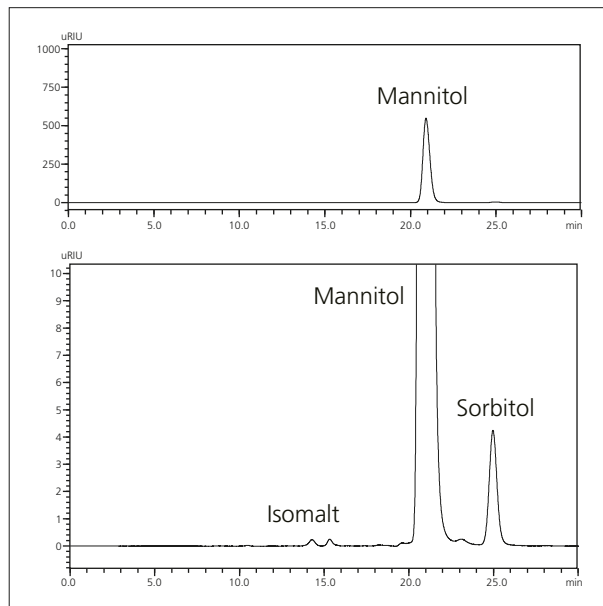

Fig. 5 Chromatogram of Pharmaceutical Excipient  
Upper: Chromatogram  
Lower: Expanded Chromatogram

Reference

1) United States Pharmacopeia, Second Supplement to USP 37-NF 32

The samples used to produce this application were kindly provided by Nihon Generic Co., Ltd.



# Application News

## No. L448

### High Performance Liquid Chromatography

## Ultra-High Speed Analysis of Ibuprofen by Nexera in Accordance with USP 621

High throughput analysis has been advancing dramatically in recent years with the increasing necessity to improve productivity and operational efficiency. HPLC has also been in the spotlight thanks to significant advances in ultra-high-speed analysis technology, in particular ultra high performance LC and micro-particle column packing material. The recently revised General Chapter 621 of the United States Pharmacopoeia (USP 621) now permits a degree of adjustment of HPLC and GC parameters, specifically aimed at satisfying the requirements of system suitability.

Here, using the Nexera ultra high performance liquid chromatograph and the Shim-pack VP-ODS conventional column, in addition to the Kinetex XB-C18 Series Core-Shell fast analysis column, we introduce examples of high-speed analysis of ibuprofen-related substances in conformance with USP 621.

### Allowable Adjustments to HPLC Parameters

Table 1 shows the parameters which may be changed according to USP 621, such as column length, particle size and flowrate, etc., in addition to the actual permissible ranges within which these LC parameters may be changed. After the allowable changes are implemented, no re-validation is required since the changes are interpreted only as method adjustments.

**Table 1 Allowable Adjustments to HPLC Parameters According to USP 621**

	USP General Chapter <621>
Column Length	±70 % change allowed
Column Internal Diameter	Changes permitted as long as linear velocity is the same
Particle Size	May be reduced to 50 % at maximum. However, may not be increased.
Flowrate	±50 % change allowed
Column Temperature	±10 °C change allowed
Injection Volume	Change is permitted if it satisfies the requirements for system suitability.
pH	±0.2 change allowed
UV Wavelength	±3 nm change allowed
Salt Concentration	±10 % change allowed
Mobile Phase Composition	The smaller of ±30 % or ±10 % of absolute volume to be selected.

**Table 2 Analytical Conditions**

System	: Nexera Method Scouting
Column	: (1) Shim-pack VP-ODS (250 mmL. × 4.6 mm I.D., 4.6 μm) (2) Kinetex XB-C18 (100 mmL. × 4.6 mm I.D., 2.6 μm)
Mobile Phase	: A: 1 % (wt / v) Chloroacetic Acid Water (pH 3.0 adjusted with ammonium hydroxide) B: Acetonitrile A/B = 2/3 (v/v)
Flowrate	: 2.0 mL/min
Column Temp.	: 30 °C
Injection Vol.	: (1) 5 μL (2) 1 μL
Detection	: SPD-20AV at 254 nm

### High Speed Analysis of Impurities in Ibuprofen with UHPLC Column

Ibuprofen is a type of non-steroidal anti-inflammatory drug (NSAID) that is used as an antipyretic and analgesic. Monographs on ibuprofen-related substances using conventional columns associated with the USP column category L1 (C18) are listed in the USP-NF<sup>1)</sup>, in which the analysis method and system suitability are specified for three substances; ibuprofen and its degradation products 4-isobutyl acetophenone and valerophenone (internal standard substance).

This paper presents our investigation into speeding up the analysis of ibuprofen-related substances listed in USP-NF in compliance with USP 621. For the analytical column, we selected the Kinetex XB-C18 (100 mmL. × 4.6 mm ID, 2.6 μm) high-speed analytical column, which is within the acceptable range of column adjustment specified in USP 621. Except for the column, all other conditions were the same as those listed in USP-NF. Fig. 1 shows the results of analysis of a mixture of Ibuprofen, Valerophenone and 4-Isobutylacetophenone using the Shim-pack VP-ODS and Kinetex XB-C18 columns, respectively, and Table 2 shows the analytical conditions used for each. Use of the Kinetex XB-C18 made it possible to reduce both the analysis time and solvent consumption to about 1/4 without compromising the separation. The results of the system suitability test are shown in Table 3 on the following page. The results of this study clearly indicate that all of the system suitability requirements have been met using the Kinetex XB-C18.

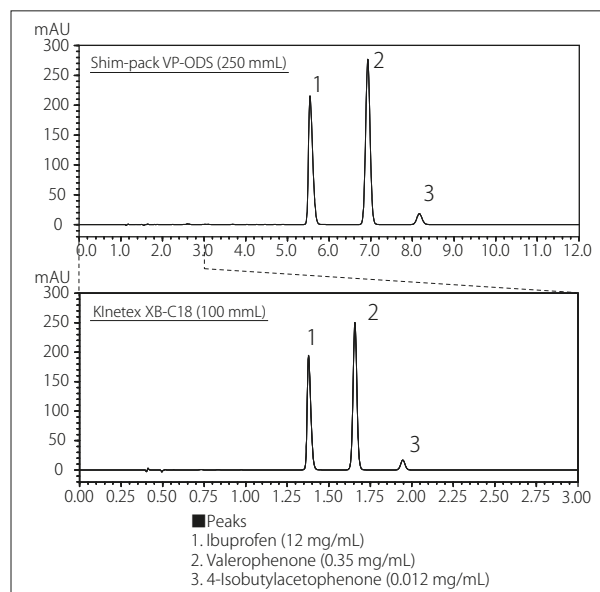

**Fig. 1 Comparison of the Shim-pack VP-ODS and Kinetex XB-C18 Series Columns -Chromatograms of a Standard Mixture of Ibuprofen, 4-Isobutylacetophenone and Valerophenone**  
Upper: Shim-pack VP-ODS (250 mmL)  
Lower: Kinetex XB-C18 (100 mmL)

**Table 3 Permissible HPLC Adjustment Ranges According to USP 621**

System Suitability Item		Reference Value	USP-Equivalent Condition	High-Speed Conditions
			ShimPack VP-ODS	Kinetex XB-C18
Relative Retention Time	Valerophenone (when the ibuprofen retention time is 1.0)	1.4	1.3	1.2
	4-Isobutylacetophenone (when the valerophenone retention time is 1.0)	1.2	1.2	1.2
Resolution	Ibuprofen and valerophenone	$\geq 2.5$	7.05	6.17
	Valerophenone and 4-isobutylacetophenone	$\geq 2.5$	5.60	5.82
Symmetry Factor	Ibuprofen	$\leq 2.5$	1.44	1.37
	Valerophenone	$\leq 2.5$	1.04	1.05
	4-Isobutylacetophenone	$\leq 2.5$	1.04	1.04
Relative Standard Deviation RSD (%)	Ibuprofen	Retention Time	$\leq 2.0$	0.028
		Peak Area Value	$\leq 2.0$	0.030
	Valerophenone	Retention Time	$\leq 2.0$	0.032
		Peak Area Value	$\leq 2.0$	0.026
	4-Isobutylacetophenone	Retention Time	$\leq 2.0$	0.036
		Peak Area Value	$\leq 2.0$	0.033

**■ Ibuprofen Impurity Test**

Impurities present in pharmaceuticals require strict management, as they can affect product quality in terms of stability, functionality and effectiveness. In the impurity test specified for ibuprofen in USP NF<sup>1)</sup>, the content of the ibuprofen decomposition product "4-isobutyl acetophenone" is required to be less than 0.1 % of the total.

Fig. 2 shows the results obtained from analysis of an Ibuprofen solution (12 mg/mL) using a UV-VIS absorbance detector (SPD-20AV), in which an expanded view of the chromatogram from approximately 0.5 minutes to 2 minutes is shown. The analytical conditions are shown in Table 4. With the wide dynamic range of the SPD-20AV, even the smallest peaks are clearly detected with high resolution and high sensitivity.

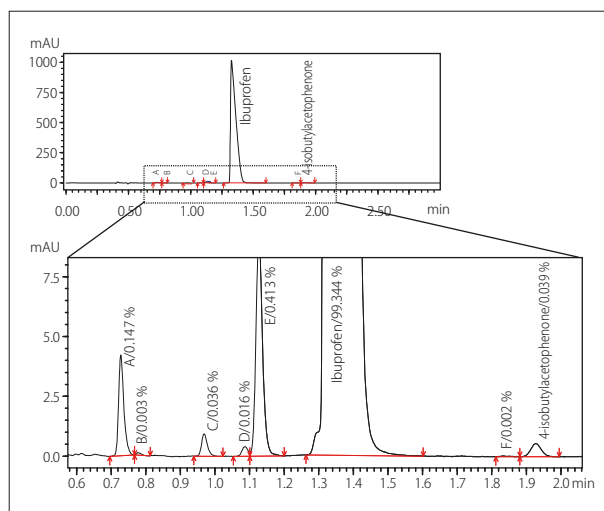

**Fig. 2 Chromatograms of Ibuprofen and Impurities**

**Table 4 Analytical Conditions**

System	: Nexera
Column	: Kinetex XB-C18 (100 mm L. × 4.6 mm I.D., 2.6 μm)
Mobile Phase	: A: 1% (wt / v) Chloroacetic Acid Water (pH 3.0 adjusted with ammonium hydroxide) B: Acetonitrile A/B = 2/3 (v/v)
Flowrate	: 2.0 mL/min
Column Temp.	: 30 °C
Injection Vol.	: 10 μL
Detection	: SPD-20AV at 254 nm

[References]

- 1) U.S. Pharmacopeia 35-NF 30, 2012
  - General Chapter <621>
  - Official Monograph " Ibuprofen "

# Application News

## No. L494

### High Performance Liquid Chromatography

## Analysis of Omeprazole by "i-Series" for USP and JP Methods

Omeprazole, a drug that effectively suppresses the excessive secretion of gastric acid, is often used for the treatment of gastric ulcer and duodenal ulcer, in addition to the treatment of reflux esophagitis. Acting as a Proton Pump Inhibitor (PPI), omeprazole is included in the WHO Model List of Essential Medicine, and considered an important component of basic medical care.

This Application News introduces an example of analysis of omeprazole in accordance with the Japanese Pharmacopoeia (JP) and the United States Pharmacopoeia (USP). Also presented here is an example of analysis that can be completed in a significantly shorter time than that described in the USP General Chapter 621 Chromatography.

The Nexera-i integrated UHPLC was used for the analysis by the procedure described in the USP. The Nexera-i supports the use of analytical conditions specified for both HPLC and UHPLC. In the case of compliance (HPLC conditions) with the Japanese Pharmacopoeia, we conducted analysis using the Prominence-i integrated HPLC.

### ■ The USP Method - Original Method

The analytical conditions specified in the USP monograph are shown in Table 1. The results of analysis of the system suitability test solution (0.1 mg/mL, acetonitrile-boric acid solution) specified in the omeprazole test method are shown in the upper chromatogram of Fig. 1. The results obtained sufficiently satisfy the threshold required with respect to both tailing factor and relative standard deviation (n = 6) specified in the monograph (Table 4).

**Table 1 Analytical Conditions (USP Original Method)**

System	: Nexera-i
Column	: Shim-pack GIST C8 (150 mmL. × 4.6 mm I.D., 5 μm)
Mobile Phase	: Acetonitrile/Phosphate (Na) Buffer (pH 7.6) = 1/3 (v/v)
Flowrate	: 0.80 mL/min
Column Temp.	: 40 °C
Injection Volume	: 20 μL
Detection	: UV 280 nm (Cell temp. 40 °C)

**Table 2 Selection of Column for Speed Enhancement**

	Column Size	L/dp	Ratio
USP Original Method	150 mmL. × 4.6 mm I.D., 5 μm	30000	1 (100 %)
USP Fast Method	50 mmL. × 3.0 mm I.D., 2 μm	25000	0.83 (-17 %)

**Table 3 Analytical Conditions (USP Fast Method)**

System	: Nexera-i
Column	: Shim-pack GIST C8 (50 mmL. × 3.0 mm I.D., 2 μm)
Mobile Phase	: Acetonitrile/Phosphate (Na) Buffer (pH 7.6) = 1/3 (v/v)
Flowrate	: 0.85 mL/min
Column Temp.	: 40 °C
Injection Volume	: 8 μL
Detection	: UV 280 nm (Cell temp. 40 °C)

### ■ Speed Enhancement for USP Method

The permissible ranges within which the analytical conditions may be modified are specified in the USP General Chapters: <621> Chromatography. Changing these analytical conditions within range makes it possible to shorten the analysis time. For details regarding changes that can be used to allow fast USP-compliant analysis, please refer to Application News L464.

Shortening analysis time can be accomplished in two ways, 1) by shortening the column, and 2) by increasing the flowrate (linear velocity). To preserve the resolution of the column, the column length and particle size may be modified as long as the ratio of L (column length) to dp (column particle size) remains in the specified range (permissible range: -25 % to +50 %). We selected a column size of 50 mmL. × 3.0 mm I.D., and 2 μm particle size. For further details, please see Table 2. The flowrate, proportional to the column cross-sectional area, and inversely proportional to the particle diameter (see text for permissible limits), was determined as 0.85 mL/min.

The instrument used for the analysis was the Nexera-i high-speed integrated UHPLC, suitable for multi-sample processing. The Nexera-i permits analysis using both HPLC and UHPLC conditions, without requiring changes to plumbing or flow cell type. This flexibility can allow legacy HPLC methods to be quickly transferred to UHPLC speed and performance.

Table 3 shows the analytical conditions using the higher speed analysis, and the chromatogram obtained from analysis of the system suitability test solution is shown in the lower part of Fig. 1. The analysis time was reduced more than 80 percent compared to that using the analytical conditions of Table 1 (Fig. 1 upper).

The results of the system suitability test are shown in Table 4. Clearly, the threshold value has been satisfied even using high-speed analysis conditions.

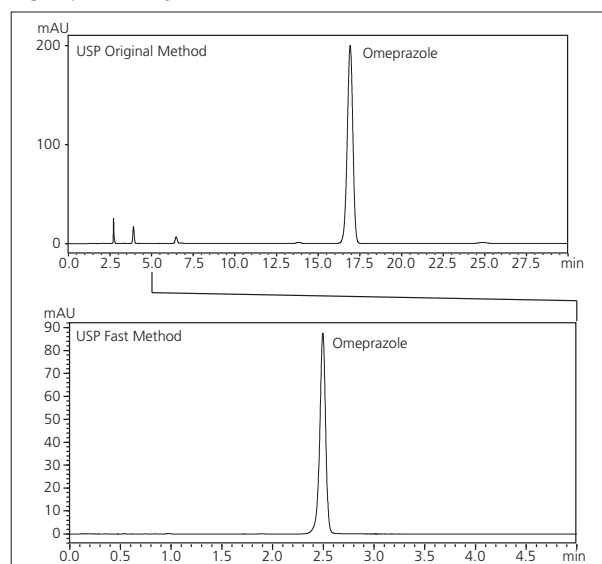

**Fig. 1 Chromatograms Conforming to USP Method (Upper: USP Original Method, Lower: USP Fast Method)**

**Table 4 Results of System Suitability Test Using USP Method (Original Method and Fast Method)**

System Suitability Requirements		Analytical Conditions			
		USP Original Method (Table 1)		USP Fast Method (Table 3)	
		Results	Judgments	Results	Judgments
USP Tailing Factor for Omeprazole	≤ 1.5	0.94	PASS	0.89	PASS
Relative Standard Deviation for Omeprazole (n = 6)	≤ 1.0 %	Rt 0.097 %	PASS	Rt 0.081 %	PASS
		Area 0.022 %	PASS	Area 0.121 %	PASS

■ **Analysis According to Japanese Pharmacopeia**

The analytical conditions specified in the 16th Edition of the Japanese Pharmacopeia are shown in Table 5. For the instrument, the integrated HPLC Prominence-i was used. The system suitability test specified in the Japanese Pharmacopeia includes three items, "Test for required detectability", "System performance", and "System repeatability". The respective chromatograms are shown in Figs. 2-4.

Regarding the test for required detectability, both the system suitability test solution (5 mg/L, prepared using mobile phase) and this solution diluted five-to-one with mobile phase are measured, and their peak areas compared. The peak area of the omeprazole in the five-to-one diluted solution was compared to the results obtained using the system suitability solution, and was determined to be approximately 20 % (within permissible range of 15-25 %).

For evaluation of system performance, omeprazole and 1,2-dinitrobenzene are dissolved in sodium borate-ethanol solution (at 100 mg/L and 250 mg/L, respectively). The solution is analyzed, and the resolution of omeprazole and 1,2-dinitrobenzene is verified. The results indicated a resolution of about 24 (permissible range is 10 or greater).

For evaluation of system repeatability, six repeat analyses of the system suitability test solution were conducted, and the peak area relative standard deviation was checked. A relative standard deviation of 0.2 % was obtained (permissible range is 2.0 % or less).

These results are summarized in Table 6.

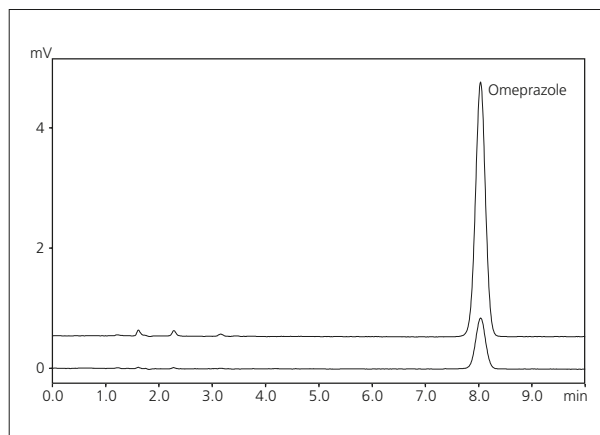

**Fig. 2 Chromatogram According to JP Method – Test for Required Detectability (Upper: 5 mg/L, Lower: 1 mg/L)**

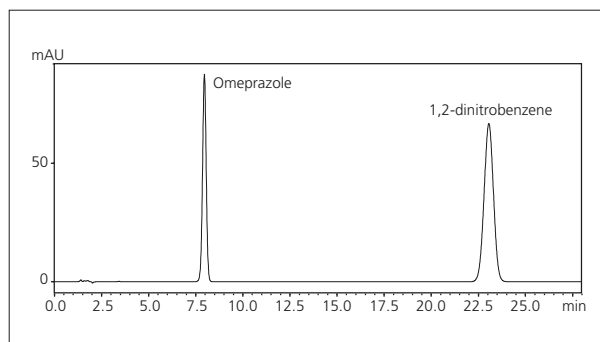

**Fig. 3 Chromatogram According to JP Method – System Performance**

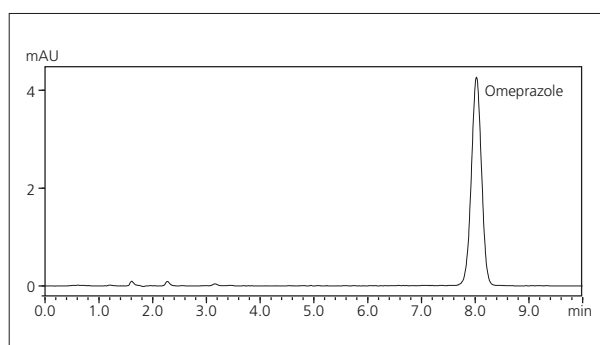

**Fig. 4 Chromatogram According to JP Method – System Repeatability**

**Table 5 Analytical Conditions (JP Method)**

System	: Prominence-i
Column	: Shim-pack GIST C8 (150 mmL, × 4.6 mm I.D., 5 μm)
Mobile Phase	: Phosphate (Na) Buffer (pH 7.6) / Acetonitrile = 29/11 (v/v)
Flowrate	: 1.3 mL/min
Column Temp.	: 25 °C
Injection Volume	: 10 μL
Detection	: UV 280 nm (Cell temp. 40 °C)

**Table 6 Results of System Suitability Test (JP Method)**

System Suitability Requirements		Results	Judgments
Test for Required Detectability	Area 15 to 25 %	19.7 %	PASS
System Performance	Resolution ≥ 10	23.6	PASS
System Repeatability	%RSD Area ≤ 2.0 %	0.202 %	PASS

# Application News

## No.L466

### High Performance Liquid Chromatography

## Analysis of Impurities in New-generation Antidepressants by Prominence-i

Pharmaceutical companies in Japan are under notification by the Ministry of Health, Labour and Welfare to carefully consider the administration of the new-generation antidepressant drugs that have been on the market since 1999 in Japan to patients under the age of 18<sup>1)</sup>. Further, to ensure the properties and suitability of these drugs, they are listed in the United States Pharmacopoeia (USP) and European Pharmacopoeia (EP).

The new Prominence-i integrated high-performance liquid chromatograph features separation compatibility with the systems of other companies. Further, use of the delay volume-compatible system kit option provides separation compatibility with the previous LC-2010 model, thereby permitting the smooth transfer of methods from the currently used instrument.

Here, using the new Prominence-i integrated high-performance liquid chromatograph, we introduce an example of analysis of compounds related to the abovementioned new-generation antidepressants.

### ■ Analysis of Impurities of Duloxetine Hydrochloride

Antidepressant drugs are psychotropic drugs that affect neurotransmitters such as noradrenaline and serotonin that are present in the brain. Among these are seven types referred to as new-generation antidepressants, and one of these, duloxetine hydrochloride, is used as a serotonin-norepinephrine reuptake inhibitor (SNRI).

We conducted measurement of duloxetine hydrochloride (0.2 mg/mL) for system suitability using the analytical conditions of Table 1, as specified in the USP<sup>2)</sup>. Fig. 1 shows the chromatogram acquired using the Prominence-i in the upper, single chromatogram trace, and the expanded views of the chromatograms acquired using (a) another company's LC system above, and that acquired using the (b) Prominence-i below, in the lower, dual chromatogram trace.

Similarly, Fig. 2 shows the chromatogram acquired using the Prominence-i in the upper, single chromatogram trace, while in the lower, dual chromatogram trace, expanded views of the chromatogram obtained using the (a) LC-2010 in the upper of the two traces, and that acquired using the (b) Prominence-i with the delay volume-compatible system kit option in the lower trace. From Fig. 1 and 2, it is clear that the Prominence-i displays separation that is compatible with the other company's LC system and the LC-2010 system.

In addition, from the results of system suitability testing (Fig. 1 (b) Prominence-i) using the system suitability solution of duloxetine hydrochloride, it is clear that system suitability was satisfied for all items, as shown in Table 2.

**Table 1 Analytical Conditions**

Column	: ZORBAX SB-C8 (150 mm L. × 4.6 mm I.D., 3.5 μm)
Flowrate	: 1.0 mL/min
Mobile Phase	: Acetonitrile / 2-Propanol / 25 mmol/L Phosphate Solution (pH 2.5) Containing 50 mmol/L 1-Hexanesulfonic Acid Sodium Salt (13 / 17 / 70)
Column Temp.	: 40 °C
Injection Volume	: 10 μL
Detection	: UV 230 nm

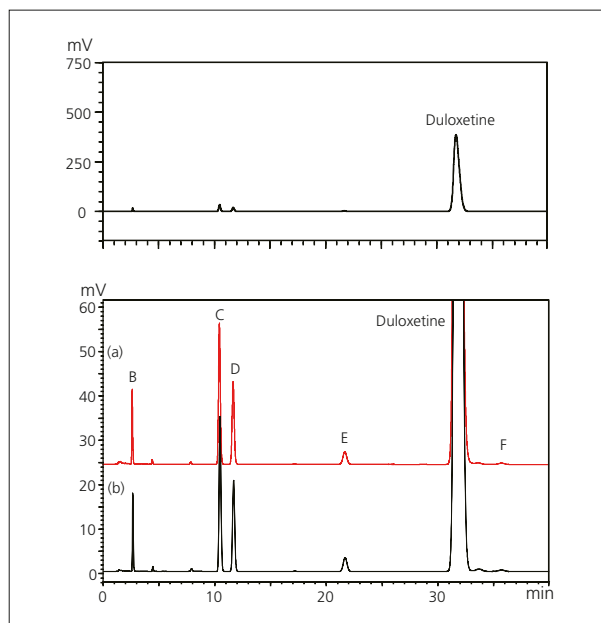

**Fig. 1 Chromatograms of Duloxetine Hydrochloride**  
Upper: Prominence-i  
Lower: Expanded Chromatograms by (a) another Company's LC System, (b) Prominence-i

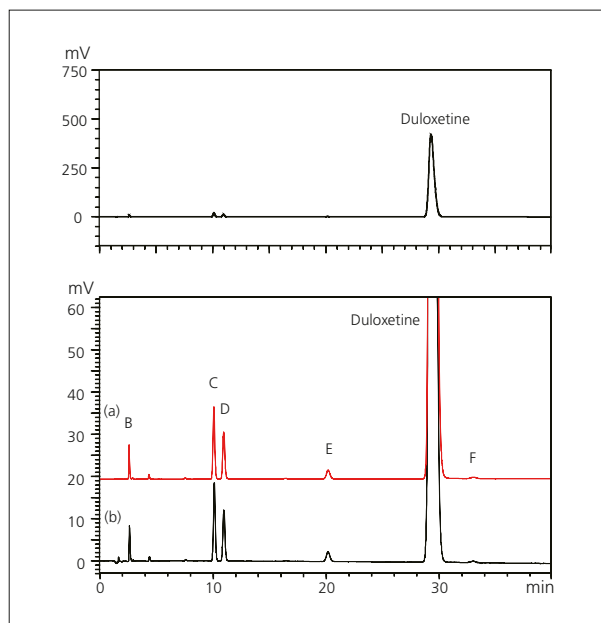

**Fig. 2 Chromatograms of Duloxetine Hydrochloride**  
Upper: Prominence-i (with delay volume-compatible system kit)  
Lower: Expanded Chromatograms by (a) LC-2010, (b) Prominence-i (with delay volume-compatible system kit)



**Table 2 Results of USP System Suitability Test Using Duloxetine (Fig. 1 (b) Prominence-i)**

System Suitability Requirements	Criteria	Observed	Result
Resolution Between Duloxetine and Duloxetine Related Compound F	≥ 1.5	4.2	PASS
Symmetry Factor for Duloxetine	≤ 1.5	1.3	PASS
Peak area %RSD for Duloxetine	≤ 1.0	0.17	PASS

**■ Analysis of Impurities of Escitalopram Oxalate**

Escitalopram oxalate is used as a selective serotonin reuptake inhibitor (SSRI). We conducted measurement of a standard solution of escitalopram oxalate (0.5 mg/mL) using the analytical conditions shown in Table 3, as specified in the USP<sup>3)</sup>. Fig. 3 shows the chromatogram acquired using the Prominence-i in the upper, single chromatogram trace, and the expanded views of the chromatograms acquired using (a) another company's LC system above, and that acquired using the (b) Prominence-i below, in the lower, dual chromatogram trace.

Similarly, Fig. 4 shows the chromatogram acquired using the Prominence-i in the upper, single chromatogram trace, while in the lower, dual chromatogram trace, expanded views of the chromatogram obtained using the (a) LC-2010 in the upper of the two traces, and that acquired using the (b) Prominence-i with the delay volume-compatible system kit option. From Fig. 3 and 4, it is clear that the Prominence-i has separation compatibility with the other company's LC system and LC-2010 system.

In addition, from the results of system suitability testing (Fig. 4 (b) Prominence-i (using the delay volume-compatible system kit option)) using the system suitability solution of Escitalopram oxalate, it is clear that the system suitability was satisfied for all items, as shown in Table 4.

**Table 3 Analytical Conditions**

Column	: Shim-pack VP-ODS (250 mm L. × 4.6 mm I.D., 5 μm)
Flowrate	: 1.0 mL/min *2.0 mL/min (45 - 60 min)
Mobile Phase	: A) Acetonitrile / 25 mmol/L Phosphate (Potassium) Buffer (pH 3.0) (1/9) B) Acetonitrile / 25 mmol/L Phosphate (Potassium) Buffer (pH 3.0) (13/7)
Time Program	: B. Conc. 5 % (0 min) → 35 % (35 min) → 100 % (45 - 60 min) → 5 % (60.1 - 68 min)
Column Temp.	: 45 °C
Injection Volume	: 20 μL
Detection	: UV 237 nm

**Table 4 Results of USP System Suitability Test Using Escitalopram (Fig. 4 (b) Prominence-i (with Delay Volume-Compatible System Kit))**

System Suitability Requirements	Criteria	Observed	Result
Symmetry Factor for Escitalopram	0.8-3	2.9	PASS
Peak Area %RSD for Escitalopram	≤ 2.0	0.067	PASS

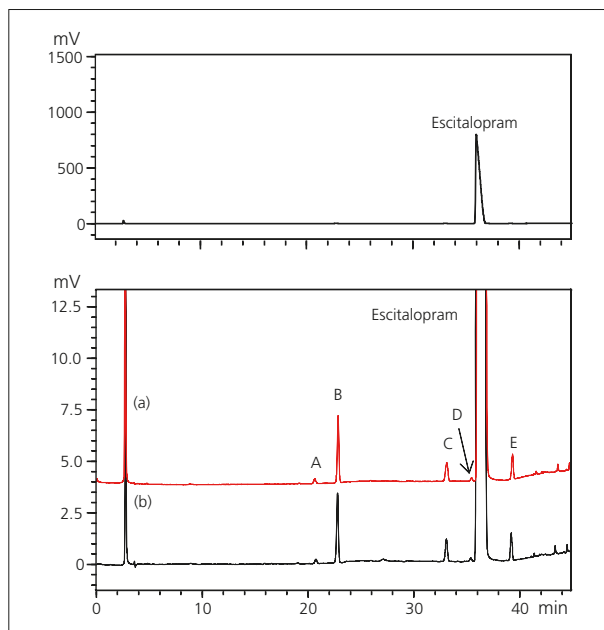

**Fig. 3 Chromatograms of Escitalopram Oxalate**  
Upper: Prominence-i  
Lower: Expanded Chromatograms by (a) another Company's LC System, (b) Prominence-i

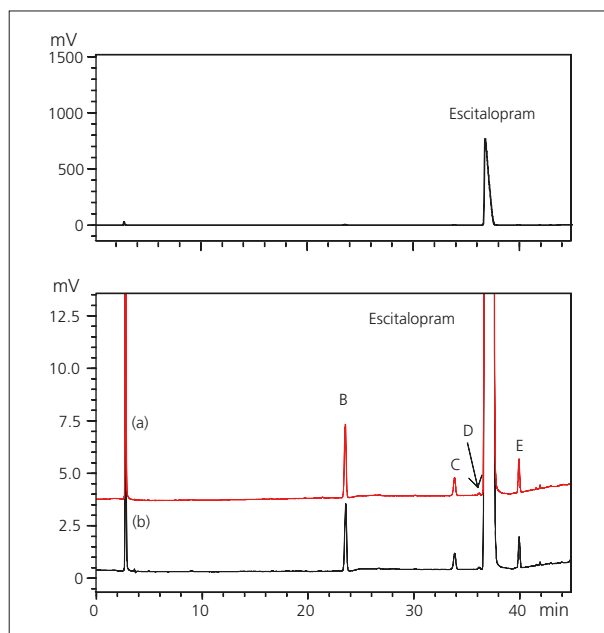

**Fig. 4 Chromatograms of Escitalopram Oxalate**  
Upper: Prominence-i (with delay volume-compatible system kit)  
Lower: Expanded Chromatograms by (a) LC-2010, (b) Prominence-i (with delay volume-compatible system kit)

[References]

- Revision to "Cautions in Usage," Notification No. 329001 by Department of Food Safety, Pharmaceutical and Food Safety Bureau, Japanese Ministry of Health, Labour and Welfare (March 29, 2013)
- Second Supplement to U.S. Pharmacopeia 35-NF 30, 2012 - Official Monographs "Duloxetine Hydrochloride"
- U.S. Pharmacopeia 35-NF 30, 2012 - General Chapters <621> - Official Monographs "Escitalopram Oxalate"

# Application News

## No.L478

### High Performance Liquid Chromatography

## High-Speed Analysis of Impurities of Pramipexole Dihydrochloride by Prominence-i

High-resolution, high-sensitivity chromatograms can be obtained using a column with small-size particle packing material. However, as the particle size decreases, the pressure applied to the column increases. The Kinetex 5  $\mu\text{m}$  core-shell column, in which the applied pressure is equivalent to that using a 5  $\mu\text{m}$  particle column, permits analysis at very high resolution. Therefore, high-resolution, high-sensitivity chromatograms can be obtained even when using a general-purpose LC system.

Here, we introduce an example in which we used the Kinetex 5  $\mu\text{m}$  core-shell column in the Prominence-i integrated high-performance liquid chromatograph, with the aim of speeding up the analysis of a drug-related substance in accordance with criteria requirements of the European Pharmacopoeia (EP).

### ■ Analysis of Impurities in Pramipexole Dihydrochloride Using the Kinetex 5 $\mu\text{m}$ Core-shell Column

Pramipexole dihydrochloride, known as a therapeutic agent for Parkinson's disease, is used as a drug to replenish the neurotransmitter dopamine.

Here, as specified in the EP, a standard solution of pramipexole dihydrochloride (1.5 mg/mL) was analyzed using the analytical conditions of Table 1.<sup>1)</sup> Chromatograms (a) and (b) of Fig. 1 correspond to the measurement results using the Kinetex 5  $\mu\text{m}$  core-shell column and the Shim-pack VP-ODS column, respectively. The lower part of the figure shows an enlarged view of the chromatograms from 3 to 10 minutes. Use of the Kinetex 5  $\mu\text{m}$  core-shell column increased sensitivity for the principal component, and the circled peak of Fig. 1 demonstrates that peak separation is achieved. In addition, the elution time of the principal component occurs about two minutes earlier than when using the Shim-pack VP-ODS.

**Table 1 Analytical Conditions**

Column (1)	: Kinetex 5 $\mu$ C18 100A (150 mm L x 4.6 mm I.D., 5 $\mu\text{m}$ )
Column (2)	: Shim-pack VP-ODS (150 mm L x 4.6 mm I.D., 5 $\mu\text{m}$ )
Flowrate	: 1.5 mL/min
Mobile Phase	: A) 67 mmol/L Phosphate (Potassium) Buffer (pH 3.0) Containing 21 mmol/L 1-Octanesulfonic Acid Sodium Salt B) Solution A / Acetonitrile (1/1)
Time program	: B Conc. 40 % (0 min) $\rightarrow$ 80 % (15 min) $\rightarrow$ 40 % (15.1 - 20 min)
Column Temp.	: 40 $^{\circ}\text{C}$
Injection Volume	: 5 $\mu\text{L}$
Detection	: LC-2030C at 264 nm
Flow Cell	: Conventional Cell for Integrated

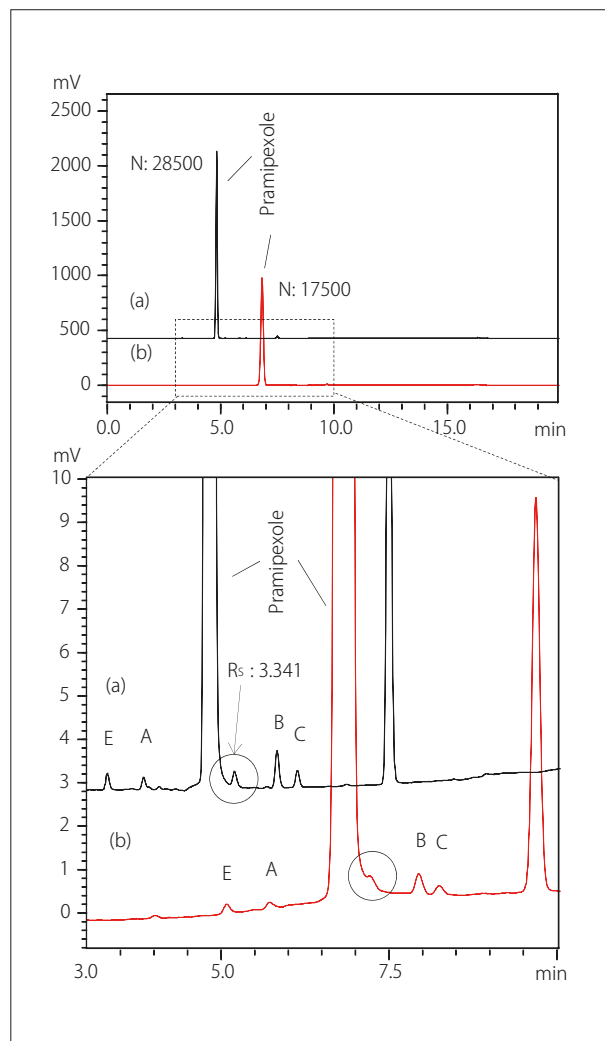

**Fig. 1 Comparison of Chromatograms of Pramipexole Dihydrochloride Using (a) Kinetex 5  $\mu\text{m}$  Core-shell Column and (b) Shim-pack VP-ODS**

### ■ Compatibility with Third-Party LC Systems

The Prominence-i is compatible with LC systems of other companies. Here, we conducted analysis of a standard solution of pramipexole dihydrochloride (1.5 mg/mL) using the analytical conditions shown in Table 1 (using Column 1) in a similar manner as used in the previous section. The chromatogram in the upper window of Fig. 2 was acquired using the Prominence-i, and those in the lower window are enlarged views of chromatograms acquired with (a) a third-party LC system, and (b) the Prominence-i. According to the results using the third-party system and the Prominence-i, there is clear compatibility of chromatogram separation.

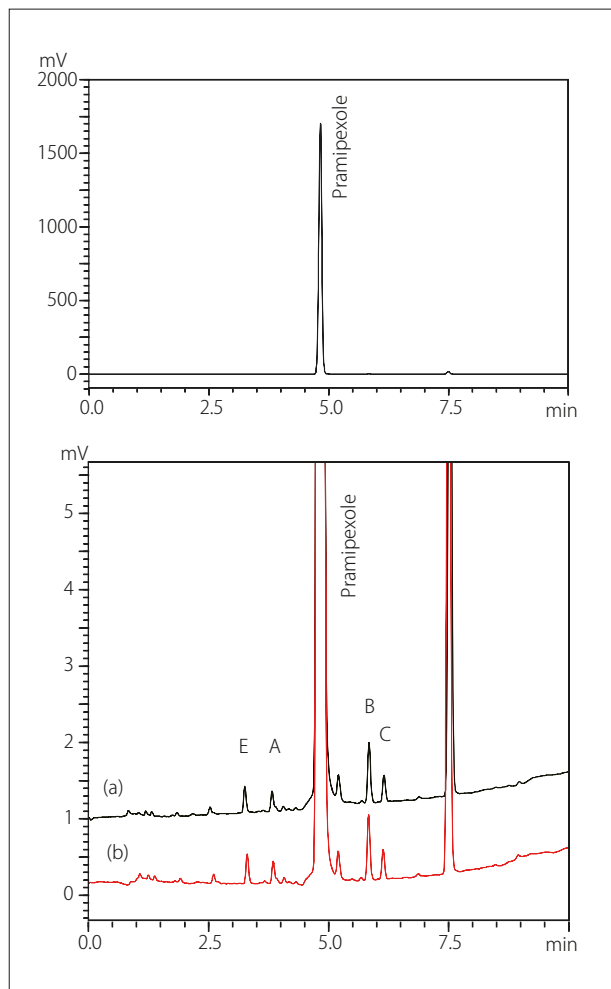

**Fig. 2 Chromatograms of Pramipexole Dihydrochloride**  
Upper: Prominence-i  
Lower: Enlarged Views of Data Using (a) Third-Party System and (b) Prominence-i

### High-Speed Analysis of Impurities of Pramipexole Dihydrochloride

We investigated the speed-up of analysis of pramipexole hydrochloride-related substances in accordance with the EP. Table 2 shows the permissible ranges within which the HPLC parameters may be changed as stipulated in the EP.<sup>2)</sup>

**Table 2 Permissible Ranges of HPLC Conditions Specified in EP**

Item	Permissible Range
Mobile Phase (Minor substances)	Select $\pm 30\%$ or absolute quantity $\pm 2\%$ , whichever is larger
(Other substances)	Absolute quantity $\pm 10\%$ change is permitted
pH	$\pm 0.2\%$ change permissible
Salt Concentration	$\pm 10\%$ change permissible
UV Wavelength	No change permitted
Column Inner Diameter	$\pm 25\%$ change permissible
Particle Size	Decrease up to 50% permissible, increase not permitted
Flowrate	$\pm 50\%$ change permissible
Column Temperature	$\pm 10\%$ change permissible (Max 60 °C)
Injection Volume	Change permissible as long as system suitability requirement is satisfied

Fig. 3 shows the chromatogram obtained from analysis of a pramipexole dihydrochloride standard solution (1.5 mg/mL) using the analytical conditions of Table 3, in which the permissible limits of Table 2 are satisfied. The lower chromatogram presents an expanded view of the region from 1 to 3 minutes. To conduct the accelerated analysis, the optional "Low-volume Tubing Kit" was used, and for the column, the Kinetex 2.6  $\mu\text{m}$  core-shell column for high-speed analysis was used. The elution time of the principal component occurred about three minutes earlier than when using the Kinetex 5  $\mu\text{m}$  core-shell column.

In addition, it is clear from the results of the system suitability test shown in Table 4, the system suitability requirement is fully satisfied in all respects, including conforming to the EP conditions as well as from the standpoint of satisfying the conditions associated with high-speed analysis.

**Table 3 Analytical Conditions - High Speed Analysis**

Column	: Kinetex 2.6 $\mu$ C18 100A (75 mm L $\times$ 4.6 mm I.D., 2.6 $\mu\text{m}$ )
Flowrate	: 2.0 mL/min
Mobile Phase	: A) 67 mmol/L Phosphate (Potassium) Buffer (pH 3.0) Containing 21 mmol/L 1-Octanesulfonic Acid Sodium Salt B) Solution A / Acetonitrile (1/1)
Time program	: B Conc. 40% (0 min) $\rightarrow$ 80% (5.63 min) $\rightarrow$ 40% (5.64 - 8.63 min) On-time injection: 230 $\mu\text{L}$
Column Temp.	: 40 °C
Injection Volume	: 2 $\mu\text{L}$
Detection	: LC-2030C at 264 nm
Flow Cell	: High-speed High-sensitivity Cell

**Table 4 Results of System Suitability Test According to EP**

System Suitability Item	Reference Value	EP-Equivalent Condition	High-Speed Condition	Judgment
Resolution - Impurity A and Pramipexole	$\geq 6.0$	8.2	9.7	PASS

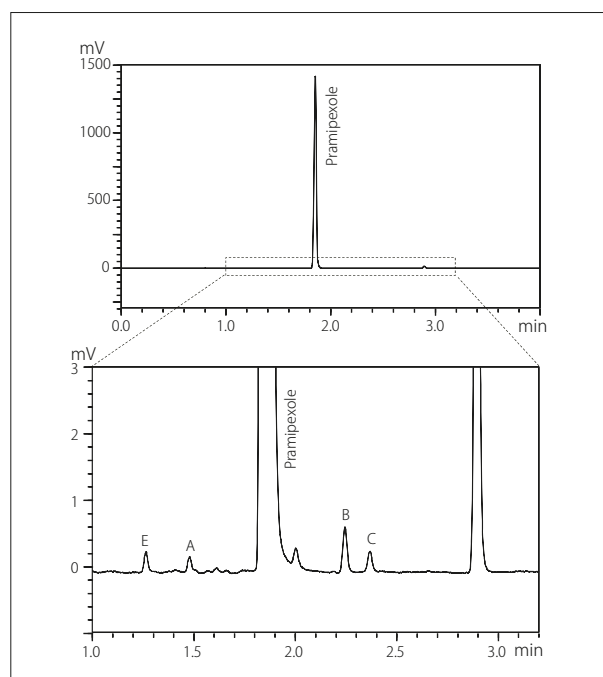

**Fig. 3 Chromatograms of Pramipexole Dihydrochloride - High-Speed Analysis (with Low-volume Tubing Kit)**

[References]

- 1) E. Pharmacopoeia 01/2012: 2416 "Pramipexole Dihydrochloride"
- 2) E. Pharmacopoeia 01/2008: 20246 General Chapters  
2. 2. 46. Chromatographic separation technique

# Application News

## No.L456

### High Performance Liquid Chromatography

## Ion Analysis in Drugs (Part 3) Determination of Counterions (Cations) by Ion Chromatography

In Application News No.L387, we introduced examples of impurity ion analysis and counterion analysis in pharmaceuticals using ion chromatography. Typically, a variety of counterions are used to selecting the optimum salts in the development stage of a pharmaceutical product because the physicochemical and pharmacokinetic properties associated with the active pharmaceutical ingredients (API) will vary depending on differences in counterions. Furthermore, as inorganic substances such as catalysts and ions used during synthetic process may affect such properties as solubility and stability, it is very important to conduct analysis of ionic contaminants. High-sensitivity analysis of these ionic contaminants, even when present at trace levels in pharmaceutical products, can be conducted using ion chromatography. Further, by adding an organic solvent to the eluent, the principle component can be eluted more quickly, thereby shortening the analysis time.

Here, we introduce examples of analysis of sodium, potassium, magnesium and calcium as the principal counter cations found in pharmaceuticals.

#### ■ Analysis of Trace Amounts of Cations

We conducted low-concentration analysis of a standard solution of sodium, potassium, magnesium and calcium. Table 1 shows the area reproducibility and retention time (n = 6), and Table 2 shows the analytical conditions used. The results of analysis of the cation standard solution are shown Fig. 1.

**Table 1 Repeatability**

	Conc (mg/L)	R.T. %RSD	Area %RSD
Sodium	2.5	0.02	0.07
Potassium	2.5	0.02	0.07
Magnesium	2.5	0.01	0.27
Calcium	2.5	0.02	0.28

**Table 2 Analytical Conditions**

Column	: Shim-pack IC-C4 (150 mm L. × 4.6 mm I.D.)
Mobile Phase	: A: 3.0 mmol/L Oxalic acid B: Acetonitrile A:B = 95 : 5 (v/v)
Flowrate	: 1.0 mL/min
Column Temp.	: 40 °C
Injection Volume	: 20 µL
Detection	: Conductivity (Non-suppressor mode)

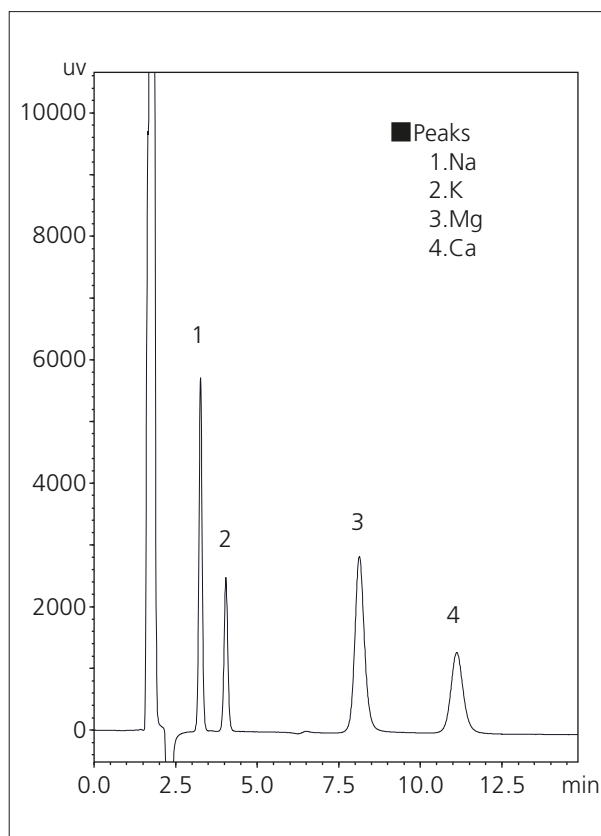

**Fig. 1 Chromatogram of a Four-Cation Standard Mixture**

### Linearity of Calibration Curves

Each counter cation was used for four standard mixtures in the concentration range from 1.25 to 10 mg/L. Then measurements were done using an electroconductivity detector to create calibration curves, which are shown in Fig. 2.

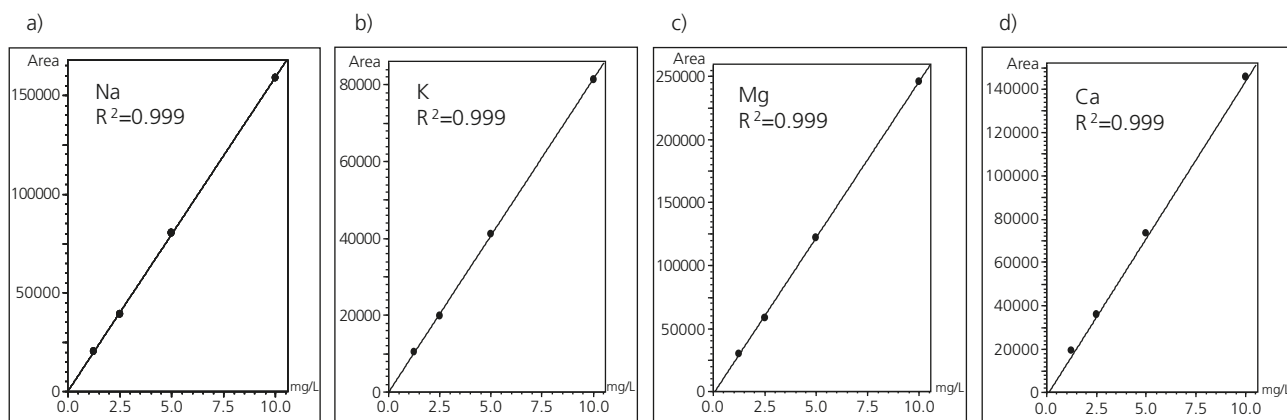

Fig. 2 Linearity of Calibration Curves  
a) Sodium, b) Potassium, c) Magnesium, d) Calcium

### Analysis of Counterions

Fig. 3 shows the results of analysis of a standard solution of diclofenac sodium (44.7 mg/L : 0.1 mmol/L) containing sodium salt, and Fig. 4 shows the results of analysis of a standard solution of benzyl penicillin (37.2 mg/L : 0.1 mmol/L) containing potassium salt. The analytical conditions are shown in Table 2. The quantitative values obtained for the counterions were 2.4 mg/L for sodium (0.1 mmol/L), and 3.9 mg/L (0.1 mmol/L) for potassium.

The mole ratios of the principal components and counterions were diclofenac : sodium = 1:1.1, and benzylpenicillin : potassium = 1:1.

In addition, the area repeatability obtained in repeat analysis (n=6) of each of the standard solutions was 0.02 % for sodium in diclofenac, and 0.09 % for potassium in benzylpenicillin, indicating excellent repeatability in both analyses.

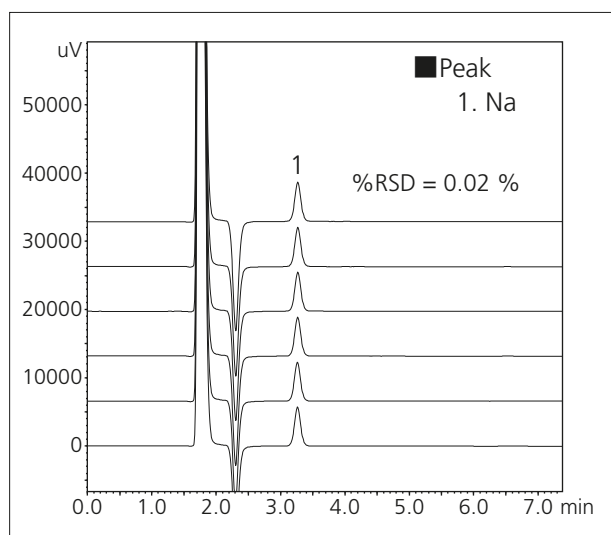

Fig. 3 Chromatogram of Diclofenac Sodium

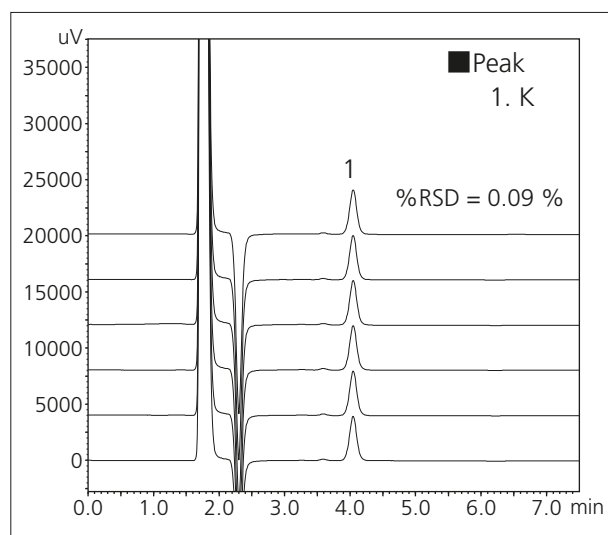

Fig. 4 Chromatogram of Benzylpenicillin Potassium



# Application News

## No.L457

### High Performance Liquid Chromatography

## Ion Analysis in Drugs (Part 4) Determination of Counterions (Anions) by Ion Chromatography

In Application News No.L387, we introduced examples of impurity ion analysis and counterion analysis in pharmaceuticals using ion chromatography. Typically, a variety of counterions are used to selecting the optimum salts in the development stage of a pharmaceutical product because the physicochemical and pharmacokinetic properties associated with the active pharmaceutical ingredients (API) will vary depending on differences in counterions. Furthermore, as inorganic substances such as catalysts and ions used during synthetic process may affect such properties as solubility and stability, it is very important to conduct analysis of ionic contaminants. In order to eliminate the impurities from the synthesized API, HPLC is commonly used for fractionation and preparative purification. For the preparation of mobile phase, acetic acid, formic acid, trifluoroacetic acid, and their salts are used as additives for easier post-processing. Additionally, in the solid phase synthesis of peptides, trifluoroacetic acid or its salt is used for the isolation of the synthesized peptide from the solid phase, so trifluoroacetate becomes the counterion for the peptide that is the principle component. In many cases, after that, salt replacement by means of acetate or chloride ions takes place before use. Consequently, such ions can become counterions or impurity ions in the API. Here, we introduce some examples of the analysis of acetate, formate, chloride, and trifluoroacetate ions in a pharmaceutical product.

### ■ Analysis of Trace Amounts of Anions

A low-concentration analysis of acetate, formate, chloride, and trifluoroacetate (TFA) ions was carried out. Fig. 1 shows the chromatogram that was obtained from the standard solution. The retention time and the area repeatability (n = 6) are shown in Table 1, and the analytical conditions used are shown in Table 2.

**Table 2 Analytical Conditions**

Column	: Shim-pack IC-A3 (150 mm L.×4.6 mm I.D.)
Mobile Phase	: A : 8.0 mmol/L <i>p</i> -Hydroxybenzoic acid 3.2 mmol/L Bis-Tris 50 mmol/L Boric acid B : Acetonitrile A : B = 95:5 (v/v)
Flowrate	: 1.2 mL/min
Column Temp.	: 40 °C
Injection Volume	: 50 µL
Detection	: Conductivity (Non-suppressor mode)

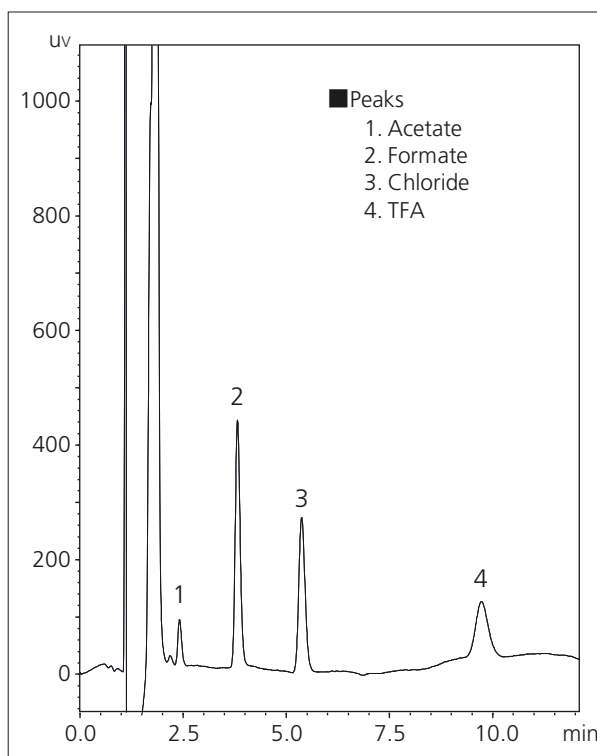

**Fig. 1 Chromatogram of a Four-Anion Standard Mixture**

**Table 1 Repeatability**

	Conc (mg/L)	R.T. %RSD	Area %RSD
Acetate	2.5	0.05	0.54
Formate	2.5	0.04	0.68
Chloride	0.5	0.03	0.78
TFA	10	0.02	0.85

### Linearity of Calibration Curves

Four standard mixtures in the following concentration ranges were prepared: acetate and formate ions 2.5 to 20 mg/L, chloride ion 0.5 to 4 mg/L, and TFA ion 5 to 40 mg/L. Then measurements were done using an electroconductivity detector to create calibration curves, which are shown in Fig. 2.

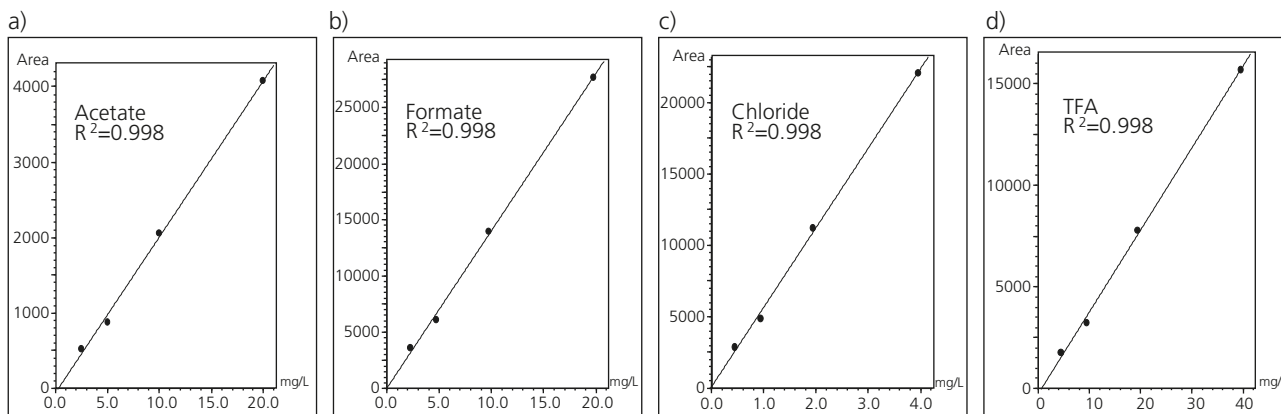

Fig. 2 Linearity of Calibration Curves  
a) Acetate, b) Formate, c) Chloride, d) TFA

### Analysis of Counterions

In the example shown in Fig. 3, a standard solution of hydroxocobalamin containing acetate (70 mg/L : 0.05 mmol/L) is analyzed. The quantitative value obtained for the counterions (acetate ions) was 3.5 mg/L (0.06 mmol/L). The mole ratio between the principal component and counterions was hydroxocobalamin : acetate ion = 1:1.2.

In the example shown in Fig. 4, a standard solution of angiotensin I containing TFA (65 mg/L) is analyzed. The quantitative value obtained for (TFA ions) was 23 mg/L (0.2 mmol/L).

The mole ratio between the principal component and counterions was angiotensin I : TFA ion = 1:6.2. Furthermore, repeated analysis of each of the standard solutions resulted in an area repeatability (n = 6) that was favorable, with acetate at 0.52 % in hydroxocobalamin and TFA at 1.15 % in angiotensin I. The conditions of the analysis are shown in Table 2.

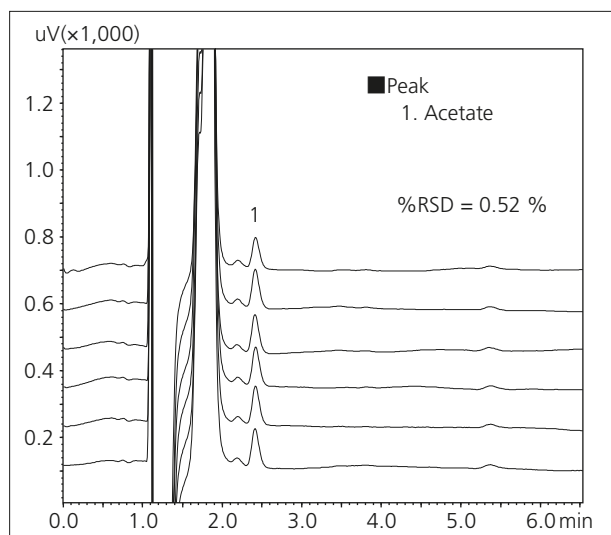

Fig. 3 Chromatogram of Hydroxocobalamin Acetate

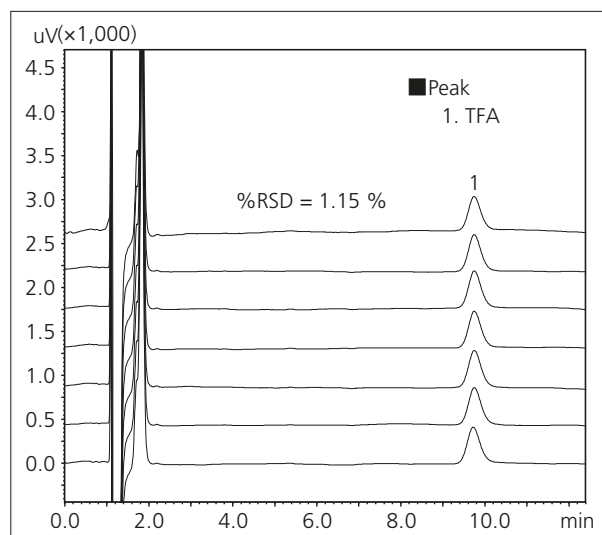

Fig. 4 Chromatogram of Angiotensin I TFA Salt

## Application News

# No. L504

### High Performance Liquid Chromatography

## Analysis of Ions in Drugs (Part 5) Analysis of Organic Acid Counterions by Ion Exclusion Chromatography

The physicochemical and pharmacokinetic properties of active pharmaceutical ingredients change depending on the counterion used, and during drug development various counterions are tested to select the optimum salt.

Residual inorganic impurities from catalysts or ions used during synthesis can also affect product solubility and stability, so it is extremely important that ion impurities are identified.

Application News No. L457 described an example analysis of chloride, formic acid, acetic acid, and trifluoroacetic acid ions present in drugs using ion chromatography. As mentioned above, drugs can contain multiple different counterions and it is sometimes difficult to separate completely the peaks of these ions using ion chromatography.

We describe an example analysis that uses ion exclusion chromatography to increase separation selectivity for formic acid, acetic acid, fumaric acid, and maleic acid, which are organic acids frequently used for drug counterions.

### ■ Standard Solution Analysis

In ion exclusion chromatography, retention strength is mainly determined by the degree of disassociation of the solute ion, and separation is performed based on the quick elution of strong acids that are unable to enter packing material pores due to a strong electrical repulsive force, and the delayed elution of weak acids that are able to enter packing material pores due to a weak electrical repulsive force.

We analyzed a 4-component standard solution containing acetic acid, formic acid, fumaric acid, and maleic acid using two ion exclusion columns.

The analytical conditions are shown in Table 1. A UV-VIS detector was used, and an aqueous solution of perchloric acid was used as the mobile phase because it is a poor absorber of UV. The results obtained after injecting 10  $\mu$ L of standard solution are shown in Fig. 1.

The number of columns (i.e., the size of the separating space) and column temperature are important factors in the separation of multi-component mixtures of organic acids using ion exclusion chromatography.

Consequently, two columns and a column temperature of 50  $^{\circ}$ C were used for the analysis of formic acid, acetic acid, fumaric acid, and maleic acid.

Table 1 Analytical Conditions

Column	: Shim-pack SCR-102H 2 columns (300 mm L. $\times$ 8.0 mm I.D.)
Mobile Phase	: 5.0 mmol/L Perchloric Acid aq. solution
Flowrate	: 0.8 mL/min
Column Temp.	: 50 $^{\circ}$ C
Injection Volume	: 10 $\mu$ L
Detection	: UV-VIS detector (SPD-20A) at 210 nm

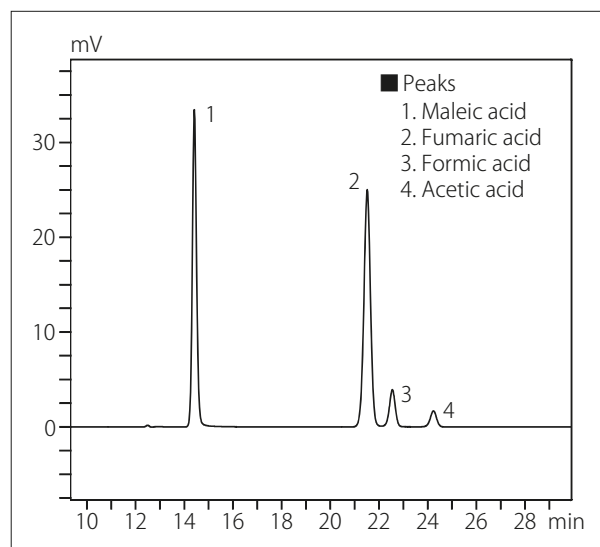

Fig. 1 Chromatogram of Standard Solution

### ■ Calibration Curve Linearity

A standard sample of fumaric acid ions was used to prepare four standard concentrations in the range of 6.25 to 50 mg/L. The calibration curve created using these standard concentrations and a UV-VIS detector is shown in Fig. 2. As shown in Fig. 2, good linearity was obtained.

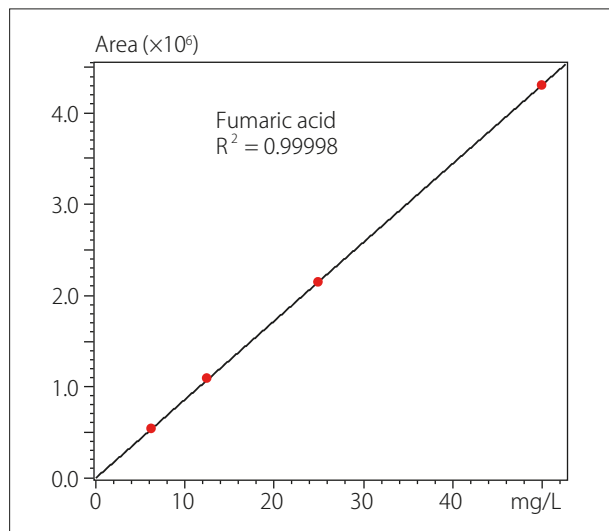

Fig. 2 Calibration Curve Linearity

### ■ Analysis of Counterions

The structural formula of the antihistamine drug clemastine fumarate is shown in Fig. 3, and an example analysis of a standard solution of clemastine fumarate (50 mg/L: 0.11 mmol/L) is shown in Fig. 4. The analytical conditions used are identical to those shown in Table 1.

The results of quantitative analysis of the fumaric acid ions present in the clemastine fumarate standard solution are shown in Table 2. Quantitative analysis showed the presence of 13.20 mg/L (0.029 mmol/L) of fumaric acid ions, which is a good recovery rate of 104.6 % when compared to the theoretical value of 12.62 mg/L.

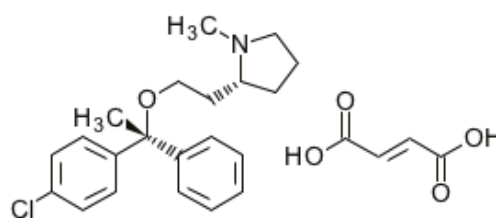

Fig. 3 Structural Formula of Clemastine Fumarate

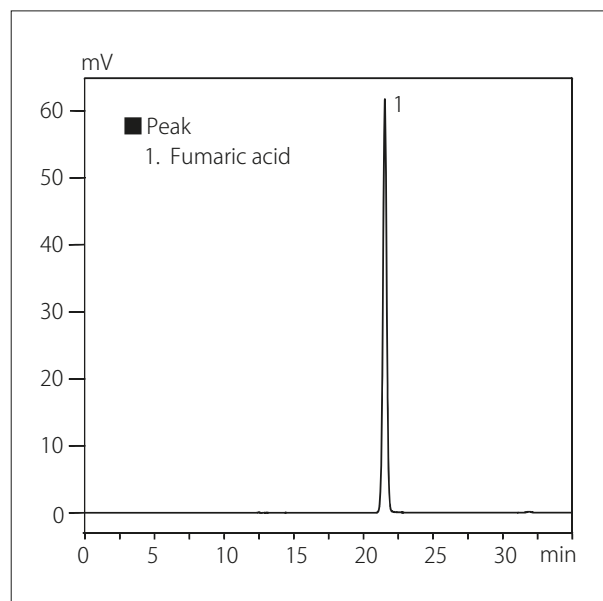

Fig. 4 Chromatogram of Clemastine Fumarate

Table 2 Results of Quantitative Analysis of Fumaric Acid Ions

Quantitative Value [mg/L]	13.20
Theoretical Value [mg/L]	12.62
Recovery Rate %	104.6

Founded in 1875, Shimadzu Corporation, a leader in the development of advanced technologies, has a distinguished history of innovation built on the foundation of contributing to society through science and technology. We maintain a global network of sales, service, technical support and application centers on six continents, and have established long-term relationships with a host of highly trained distributors located in over 100 countries.

For information about Shimadzu, and to contact your local office, please visit our website at [www.shimadzu.eu](http://www.shimadzu.eu)



**Shimadzu Europa GmbH**  
Albert-Hahn-Str. 6-10 · D-47269 Duisburg  
Tel.: +49 - (0)203 - 76 87-0  
Fax: +49 - (0)203 - 76 66 25  
[shimadzu@shimadzu.eu](mailto:shimadzu@shimadzu.eu)  
[www.shimadzu.eu](http://www.shimadzu.eu)