

# PEGASUS<sup>®</sup> BT

## GC-TOFMS



**LECO**  
EMPOWERING RESULTS

## Smart on Data. Smart on Size.

Today's laboratories are being asked to do more everyday—more samples run, more data acquired, more chemical information processed, and more results achieved—all in less time, and for less money.

A smart investment for any laboratory looking to perform qualitative or quantitative analysis of knowns and unknowns, the *Pegasus BT* GC-TOFMS is the first benchtop GC time-of-flight mass spectrometer to deliver higher sample throughput, better chemical information, and very low maintenance costs resulting in improved overall productivity in your laboratory and results that are of the highest quality.



# Features of the Pegasus BT GC-TOFMS

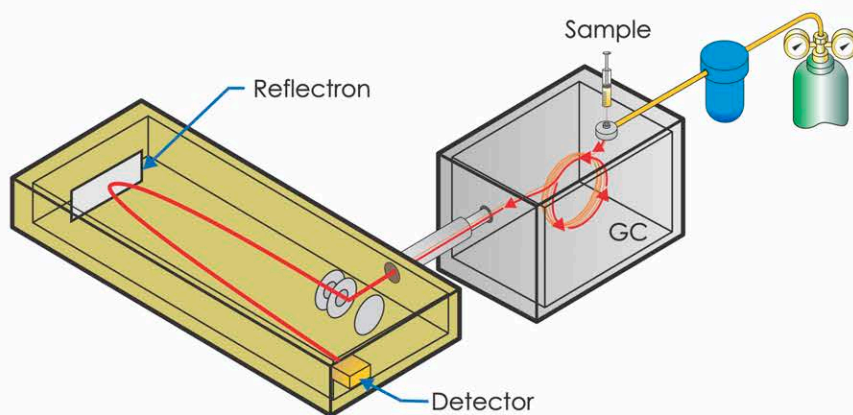

- Industry-leading sensitivity helps you find and quantify an unlimited number of analytes, while working with proprietary deconvolution algorithms to yield clean, high-quality spectra.
- Complete historical record of mass spectral components for each sample is retained for future data mining.
- The tried-and-tested reliability and durability of our StayClean® ion source on a convenient benchtop unit.



Obtaining better chemical information is really only part of the solution. What to do with all that data? We have a solution for that—our exclusive ChromaTOF® brand software package works seamlessly with your Pegasus BT to efficiently process your data and remove the guesswork involved with analyte identification, quantitation, and reporting.

- Peak Tables link library search results with deconvolution for easy review and comparison
- Apply filters to any parameter and easily see what you are interested in, then save and re-use on any data file
- Easy-to-configure interface to review data the way YOU want; easily save and re-use for other analyses
- Databases feature contains all information regarding your project—including sample information, metadata, data, methodology, and reports
- Acquisition control for automated batch and sample handling; including automated data processing
- Quantitation section allows easy review of chromatograms and their integration, calibration curves, and results
- Management of libraries such as NIST or Wiley, with the ability to create your own spectral databases
- Compare data side-by-side using the Reference feature
- Diagnostics provide a detailed look at the system; pressure of the vacuum, ion source parameters, and a quick run feature





# Application Analysis Using the Pegasus BT

Fast, efficient, and sensitive analysis of pesticides.

## Calibration Curve in Strawberry Matrix: Cyprodinil

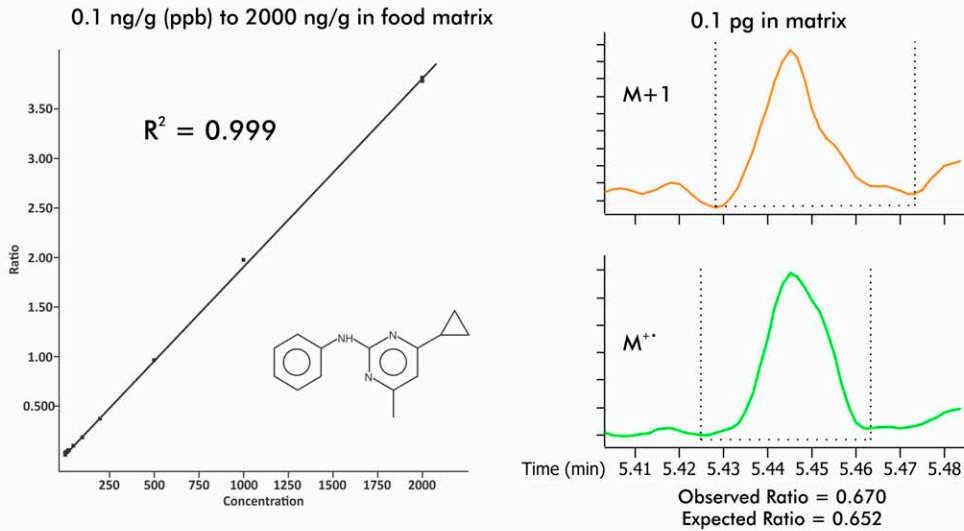

The calibration curve at left shows excellent linearity, and sensitivity easily meets all standard requirements.

## Characterization of fuel markers at trace levels is easy and routine.

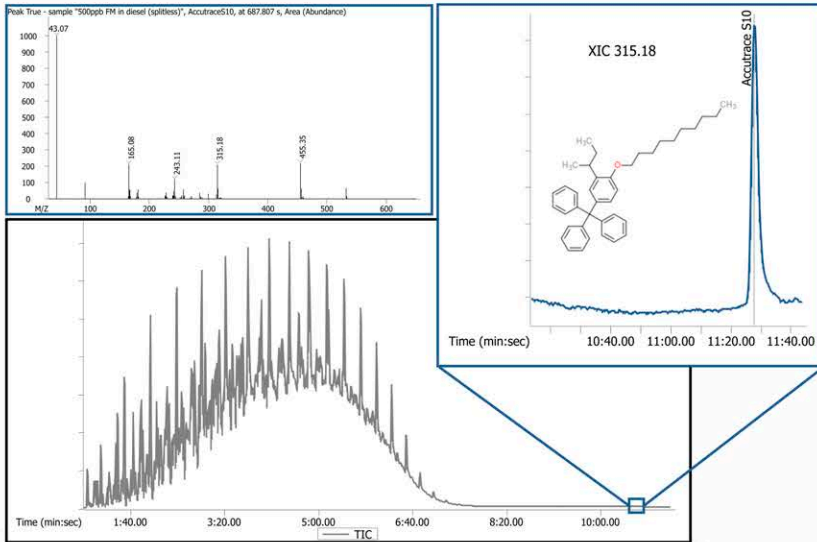

Full TIC chromatogram of a spiked commercial diesel sample.

## ASTM 5769 method requirements are exceeded and total aromatics in finished gasoline can be investigated.

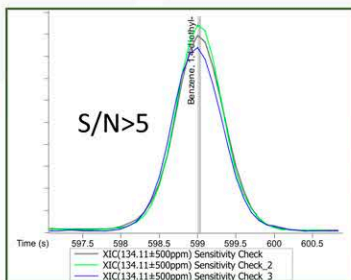

Sensitivity = Valid

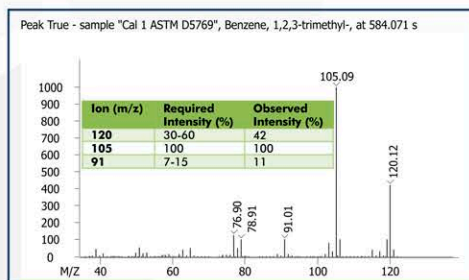

Ion Abundance = Valid

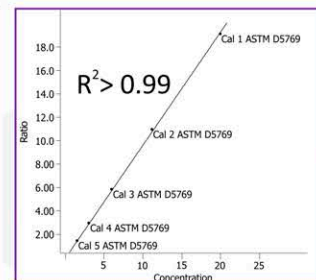

Calibration = Valid

# Benefits of the Pegasus BT GC-TOFMS

The Pegasus BT combines new, compact GC mass spec hardware with our powerful ChromaTOF brand software, giving you high instrument performance, complete and comprehensive data for simplified routine analysis. Ideal for pesticides, metabolomics, petroleum, and food/flavor/fragrance quality analysis applications.

## StayClean Ion Source

Open-style EI source virtually eliminates downtime associated with source cleaning\*, which means you can spend your time running more samples.

\*Even after 3,000 sludge injections, source has not needed cleaning.

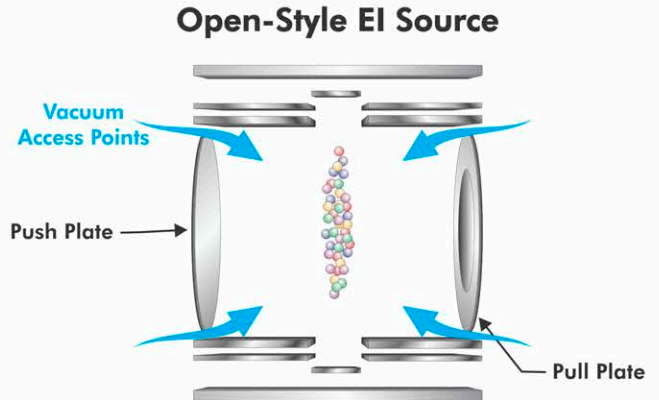

Eight pesticides identified within 5 sec R.T.

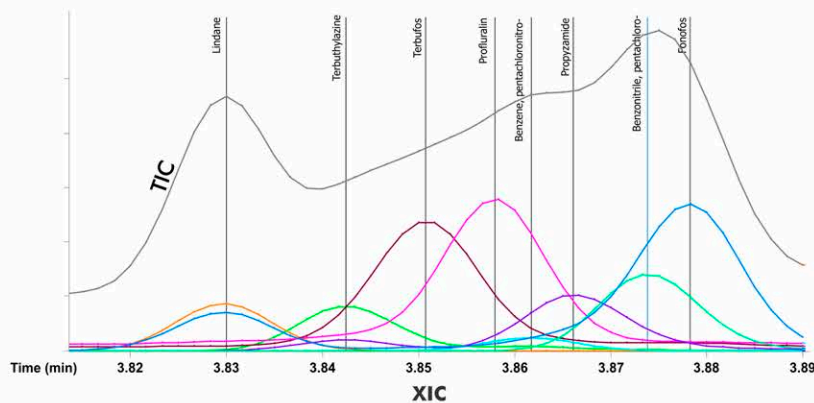

## NonTarget Deconvolution® (NTD®)

Automated deconvolution ensures that coeluting peaks and matrix interferences don't hinder your analyses.

## Detection Limit

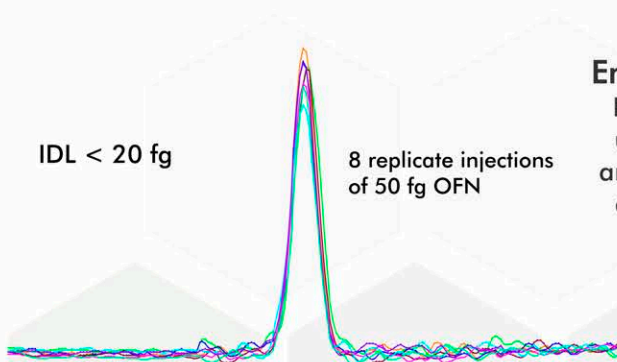

## Enhanced Sensitivity

Find and quantify an unlimited number of analytes—in every run, every time. No need for additional targeted analyses.

## Quantitative Dynamic Range

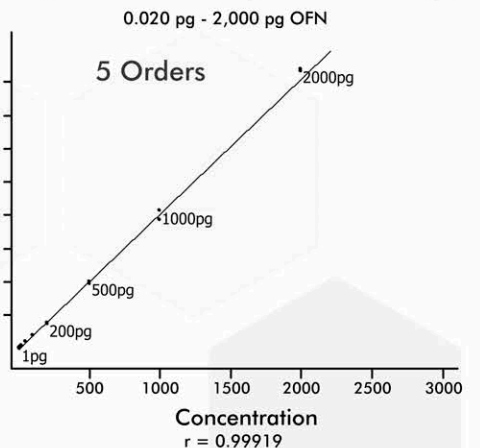

# A Commitment to Quality and Service



Technical Research Center



Customer Demonstration and Application Center

Our global network of sales/support includes over 25 subsidiaries worldwide, and is dedicated to customer service and satisfaction. Our commitment to quality is further underscored with ISO-9001:2015 certification. We conform to CE quality and safety specifications, fully testing instruments at our on-site Compliance Testing Center.

## Training Classes

Get the most out of your LECO instrument with instrument-specific training classes offered from LECO. Typical classes feature a comprehensive overview of the theory of operation, method development, method optimization, and proper maintenance for each instrument class. A variety of advanced features are also presented, including quantitation, user library creation, reporting, user fields, and optimization of both 1D and 2D chromatography. Classes also allow for networking opportunities and the ability to learn from other users of our GC-TOFMS, GCxGC, and GCxGC-TOFMS products. Attend classes at our facilities in St. Joseph, Michigan, or virtually anywhere with our online series of classes.



*"Everyone is very knowledgeable (brilliant, if I may say!) and willing to help with any questions/problems. I am amazed at and extremely happy with the high level of service LECO provides."*

*~LECO Customer and Class Participant*

LECO, Pegasus, ChromaTOF, StayClean, NonTarget Deconvolution, and NTD are trademarks of LECO Corporation.

3000 Lakeview Avenue | St. Joseph, MI 49085 | 800-292-6141 | Phone: 269-985-5496  
info@leco.com | www.leco.com | ISO-9001:2015 Q-994 | LECO is a registered trademark of LECO Corporation.

**LECO Corporation**

**LECO**

EMPOWERING RESULTS

© 2019 LECO Corporation