

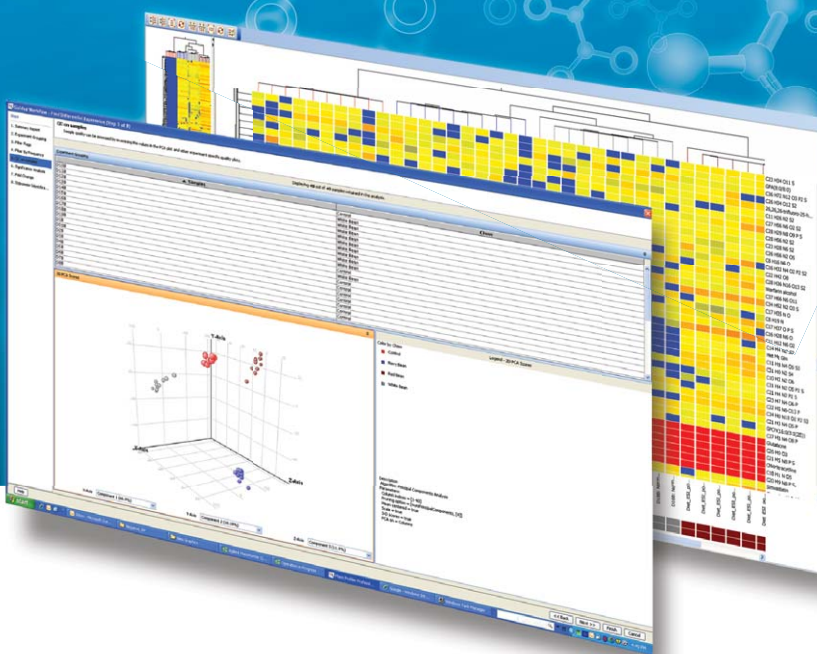

Agilent Mass Profiler Professional Software

DISCOVER THE DIFFERENCE IN YOUR DATA

The Measure of Confidence



Agilent Technologies

THE FASTEST, EASIEST WAY TO EXPLORE RELATIONSHIPS IN COMPLEX MASS SPECTRAL DATA

Welcome to Agilent Mass Profiler Professional — a Chemometrics Software Package Designed Specifically for Mass Spectrometry Data.

When just a single MS experiment can generate megabytes of data, sorting out what's meaningful is like finding a needle in a field of haystacks. Using a combination of advanced processing capabilities and powerful statistical and mathematical models to analyze complex MS data sets, Mass Profiler Professional lets you easily classify, compare, and analyze sample groups. So you can not only find the needle, you can also characterize the haystacks.

GC/MS, LC/MS, CE/MS and ICP-MS — All Together

A robust, stand-alone software solution, Mass Profiler Professional handles many types of processed Agilent mass spectral data, including GC/MS, LC/MS, CE/MS, and ICP-MS. You can even analyze different experiment types in a single project—GC/MS and LC/MS, for example.

A single, consistent user interface supports all data types to reduce training time, minimize operator errors—and significantly increase your laboratory's productivity.

Find the Relationship You're Looking For

Mass Profiler Professional integrates smoothly with Agilent MassHunter Workstation, as well as Agilent OpenLAB ChemStation, and is ideal for any MS-based application where you need to determine relationships among sample groups and variables, including:

- Metabolomics
- Food safety
- Forensics
- Petrochemical
- Proteomics
- Environmental
- Toxicology
- Biofuels



You Don't Have to be a Statistician to Get Excellent Results

Mass Profiler Professional was designed for mass spectrometry data. So even though you're using a very powerful statistical package, you'll find navigation easy and intuitive. Using a guided workflow with predefined steps based on the data type and your knowledge of the experimental conditions, a first-time user can quickly perform a basic analysis.

And for the expert user, there is an advanced workflow that guides you through the data import and then gives you all the functionality you could ask for — including comprehensive analysis and visualization features based on the different filtering, normalization, and standard statistical methods. All of the analysis tools are wizard-based, with well-chosen default parameters that also offer easily customized settings to give you maximum flexibility in your analysis.

Recursive analysis — a unique feature of Mass Profiler Professional — lets you easily remine data sets, based on preliminary data, to improve the quality of statistical analysis results. It's also easy to export an inclusion list for Q-TOF MS/MS analysis and re-import the results into Mass Profiler Professional.

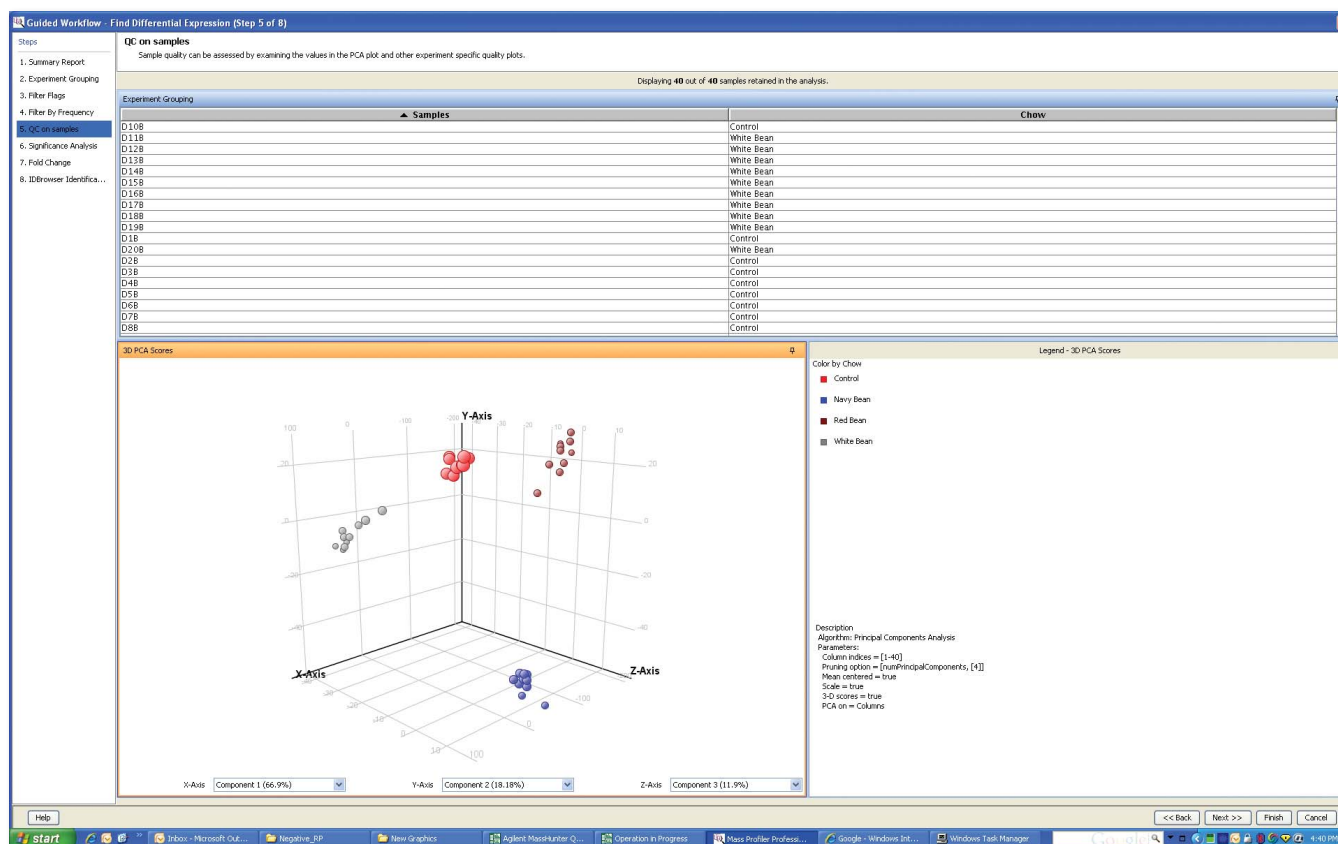

Guided workflows simplify your data analysis tasks. All of the analysis tools are wizard-based, with well-chosen default parameters that also offer easily customized settings to give you maximum flexibility in your analysis.

THE WAY TO A DEEPER UNDERSTANDING OF YOUR DATA

Mass Profiler Professional's powerful analytical capabilities fully exploit the high information content of mass spectrometry data. With functionality for unsupervised (classification without prior group assignments) or supervised (using preclassified groups) analysis, the software lets you:

- Quickly and easily discover differences between sample groups
- Plot changing patterns of compound abundances over time
- Develop useful multivariate models for class prediction

Advanced visualization tools let you inspect and annotate your results in new ways — giving you the ability to interact more productively with your data and turn it into understanding.

Finding the Important Chemical Differences in Your Data

Complex chemical samples and their observable physical manifestations are the result of abundance relationships between the different chemical components. This phenomenon can be explored by comparing sample abundance profiles, typically using Principal Component Analysis (PCA), a mathematical method of compressing complex data into a few variables.

PCA is used in an unsupervised fashion to find differences between sample groups, to determine group associations, and to weigh relative contributions of compounds to the separation of the groups. Mass Profiler Professional also contains a Find Minimal Masses algorithm designed to find the most important compounds that explain the differences between sample groups.

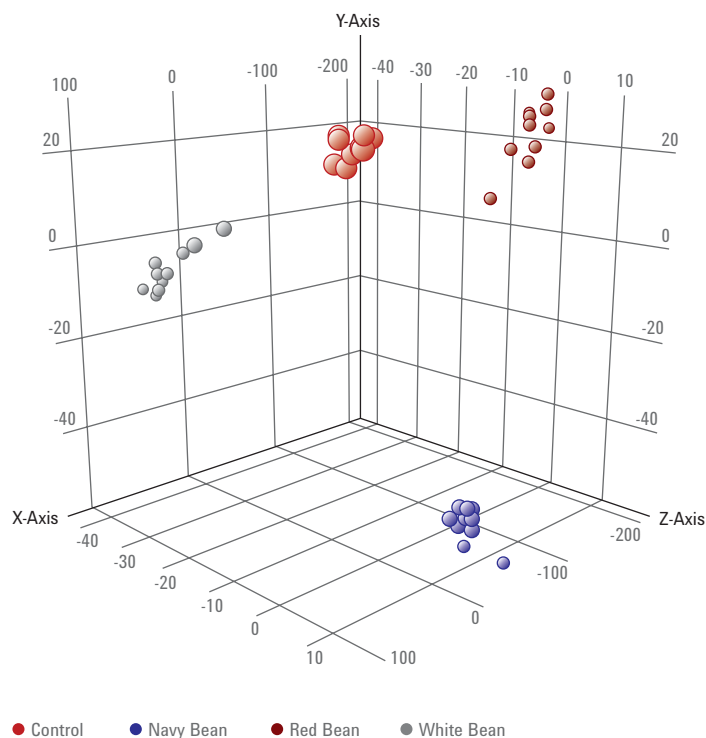

Principal Component Analysis (PCA) of metabolite data from biological replicate samples shows differences between a rat chow diet supplemented with red, white, or navy beans.

Determining Significant Abundance Differences of Compounds Across Groups

Is the data you're observing statistically valid, or are you looking at the result of normal variation among samples? Student t-tests and Analysis of Variance (ANOVA) tests can help you answer that question by finding entities with differential abundance between two or more sets of experimental conditions.

To find these entities of interest in a statistically rigorous fashion, Mass Profiler Professional provides a broad set of tests that include:

Student t-tests and Analysis of Variance (ANOVA) tests

- Paired and unpaired t-test
- Paired and unpaired Mann-Whitney

- ANOVA: equal and unequal variance
- Kruskal Wallis non-parametric one-way ANOVA
- Friedman non-parametric two-way ANOVA
- Repeated Measures ANOVA

N-way ANOVA

- Family-wise error rate and false discovery rate
- Multiple testing corrections
- Post-hoc tests
 - Tukey
 - Student-Newman-Keuls

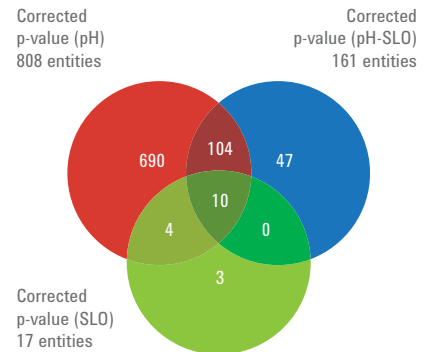

Venn diagram showing the union of two-way ANOVA. In this experiment, the contribution of two variables, pH and Streptolysin O (SLO), is shown for metabolites extracted from malaria infected red blood cells. Projecting the results of two-way ANOVA onto a Venn diagram clearly shows the statistically meaningful contributions of each variable.

Visualizing Differences By Fold-change Analysis

Small sample groups and undersampled data sets can result in p-values of questionable statistical validity. In such cases, you can use the fold-change setting as a filter to look for differences between two groups and to assess the significance of those differences based on your knowledge of the data set.

Compound	p-value	Corrected	FCAbsolute	regulation
1-hexadecanyl-2-(8-{3}-laddera...	3.667E-8	1.333E-6		16.0 down
SM(d18:1/22:0)	1.708E-8	7.982E-7		16.0 down
1-(10-methylhexadecanyl)-2-(8-...	9.659E-9	5.532E-7		16.0 down
SM(d18:0/22:0)	1.808E-4	3.225E-3		16.0 down
1,2-di-(9Z-hexadecenoyl)-3-(9Z...	1.398E-8	6.976E-7		16.0 down
1-(9Z-hexadecenoyl)-2-(9Z,12Z-...	1.143E-9	1.681E-7		16.0 down
Ceramide_C16:0	3.417E-4	6.051E-3		11.72 down
PC_C32:0	3.165E-6	6.058E-5		16.0 down
PE_C36:2	2.939E-5	5.415E-4		16.0 down
TAG_C48:0	1.128E-4	2.027E-3		4.82 down
3-keto palmitic acid	1.140E-8	6.063E-7		16.0 up
Galabiosylceramide (d18:1/16:0)	4.851E-7	1.063E-5		16.0 up
CPEn(19:0/24:0)U	2.954E-7	6.798E-6		16.0 up
CPEn(22:0/20:1(11Z)) + 62.8049...	2.747E-8	1.100E-6		16.0 up
Ubiquinone 9	5.297E-8	1.682E-6		16.0 up
SM(d18:1/26:0)	2.226E-6	4.342E-5		16.0 up
CPGro(17:0/20:4(5Z,8Z,11Z,14Z))...	2.467E-7	5.775E-6		16.0 up
267.159487.607479	5.223E-6	9.860E-5		16.0 down
671.8996@15.183417	8.084E-5	1.465E-3		16.0 down
671.3969@15.253203	1.265E-4	2.266E-3		16.0 down
278.2843@34.171165	5.300E-11	1.282E-8		16.0 down

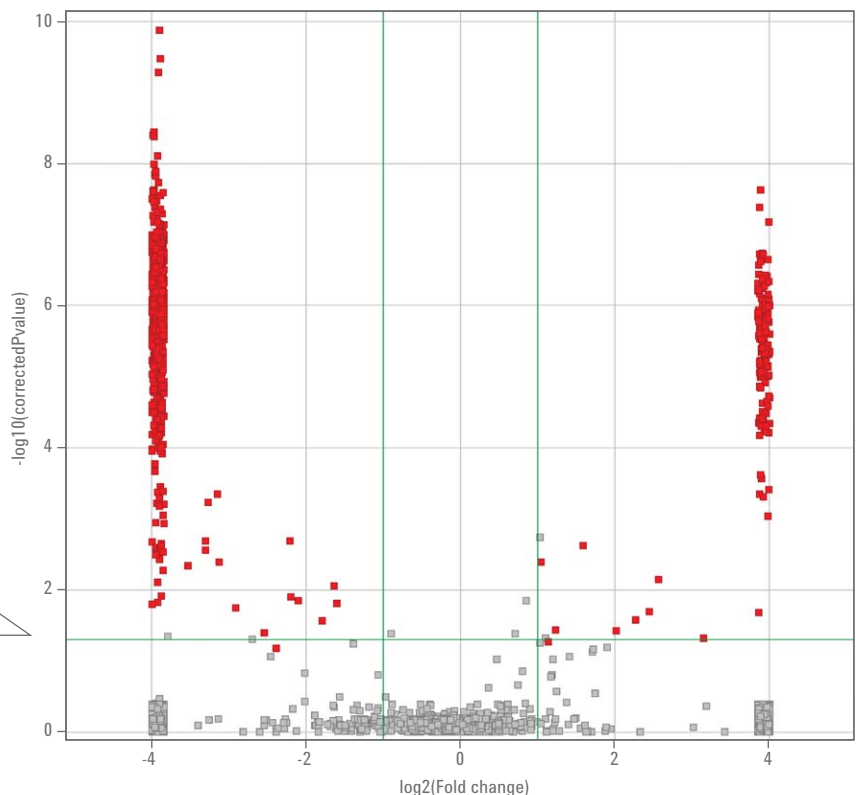

Volcano Plot functionality lets you simultaneously calculate the fold-change in abundance for each mass entity as well as p-value significance. You can interactively change both p-value and fold-change settings and view the results in graphical as well as table format.

Clustering Data to Find Hidden Relationships

Clustering groups mass entities based on the similarity of their abundance profiles, allowing you to uncover the most prominent patterns in the data.

Clustering analysis by entity profiles across samples classifies compounds that have

similar abundance profiles, letting you test for entities displaying either similar or mirror-image abundance profiles. This type of analysis is typically used to visualize substrate-product relationships in chemical or enzymatic reaction monitoring across time. Interesting relationships may be

revealed, as entities that exhibit similar behavior across a set of experimental conditions may share similar reaction pathways.

Mass Profiler Professional provides a broad choice of clustering methods, including:

- K-means clustering
- Hierarchical clustering
- Self-organizing maps (SOM)

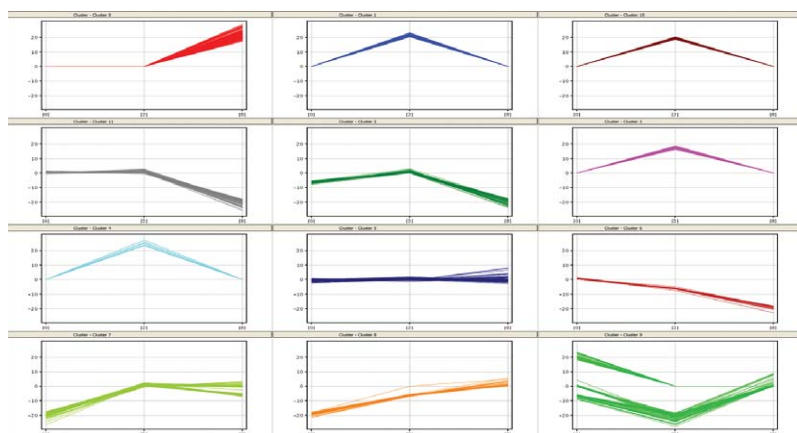

K-means cluster analysis partitions entities into a fixed number (k) of randomly assigned clusters such that entities/conditions within a cluster are similar, while those across clusters are dissimilar.

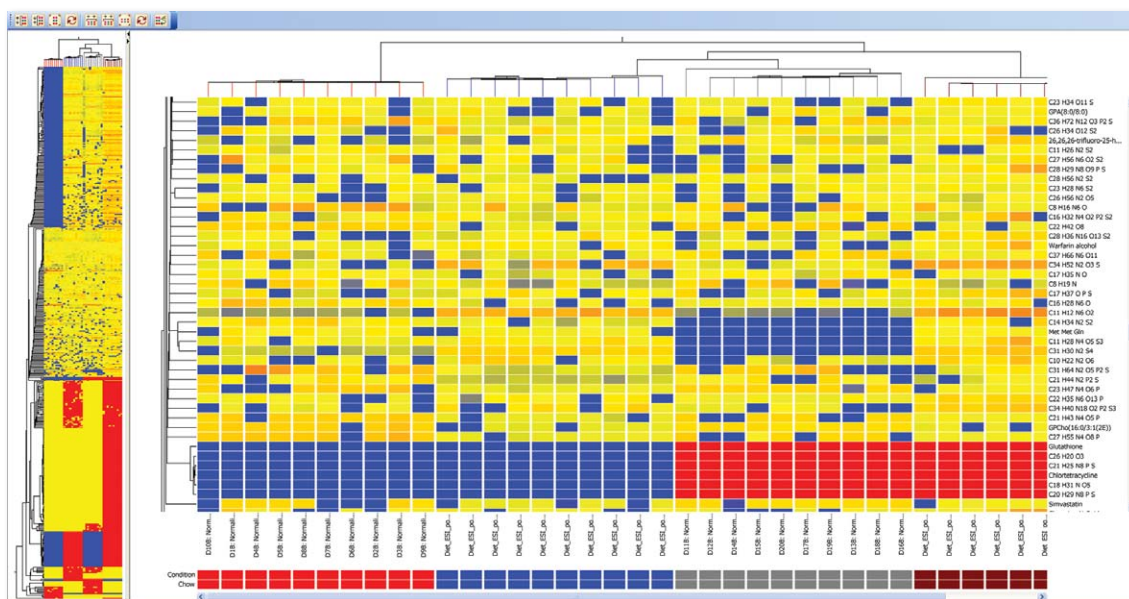

Hierarchical clustering connects similar abundance profiles together in a group within a tree structure. The dendrogram view reveals the relationships between mass entities in one dimension and between samples in the other dimension. In this example, rat chow diets with differing bean supplements show similarities in abundance profiles for the replicate samples.

Using a Prediction Model to Assign a Sample to a Group

Class prediction analysis is a valuable technique when your long-term purpose is to predict new samples into previously determined groups in an unbiased fashion. It is becoming an increasingly valuable tool in prioritizing compound pipelines and eliminating costly failures in drug development. This technique is also used in quality control of complex samples, such as beer and wine.

Samples are assigned to groups based on a prediction model; instead of trying to determine which entities within a group define that group in class prediction

analysis, you are allowing the prediction model to determine the classification based on certain entities that have already been identified.

Mass Profiler Professional offers several class prediction algorithms:

- Partial Least Squares Discriminant Analysis (PLSDA)
- Decision Tree
- Support Vector Machine
- Naïve Bayes
- Neural Network

A menu-driven wizard guides you through the process of building and running a prediction, collecting input about the entity list to use, selecting the interpretation type, and choosing which algorithm to apply.

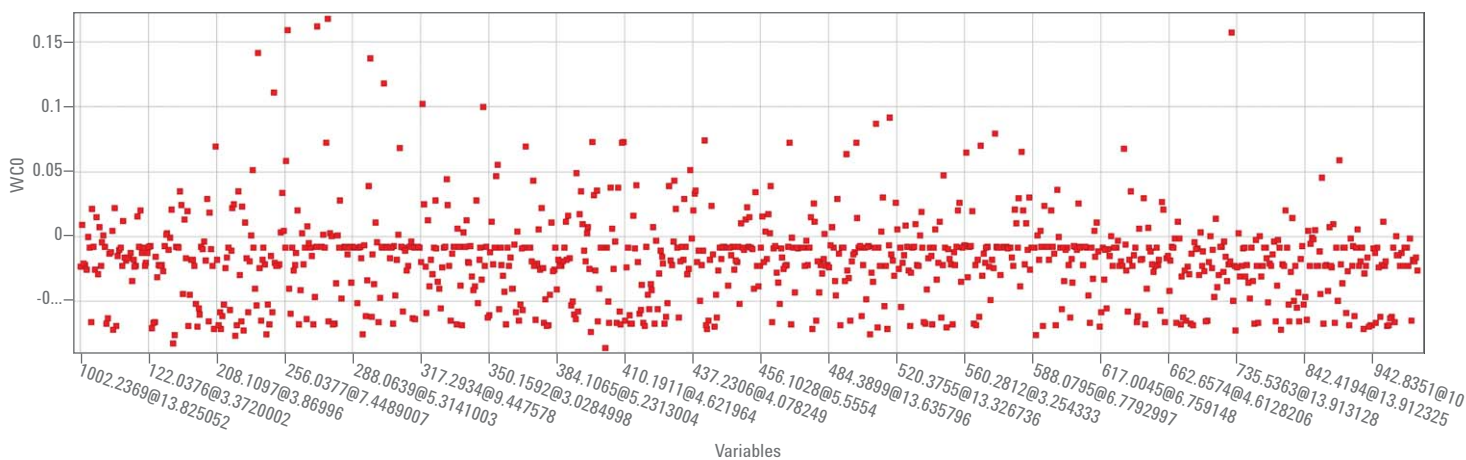
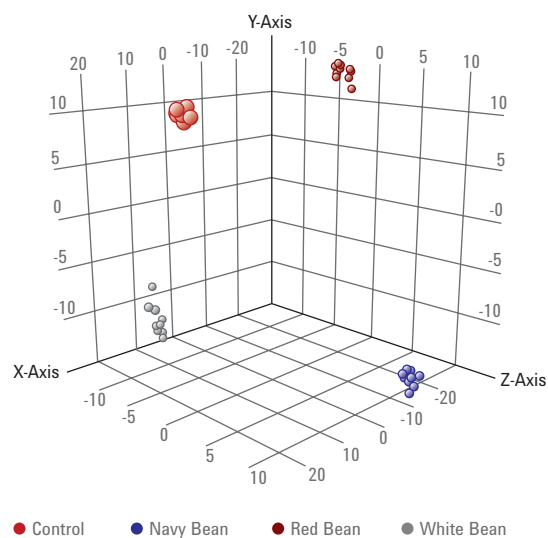

Class prediction analysis. Class prediction algorithms (in this case, PLSDA) are used to generate classification results summarized as visual outputs, including a t-scores plot of the samples (top) and a loading plot for each mass in the entity list (bottom).

BUILT-IN ID BROWSER AUTOMATES DATABASE AND SPECTRAL LIBRARY SEARCHES

At some point in your investigation, you will want to convert entities into compounds in order to understand the results of your analysis and identify the chemicals that are responsible for the observed differences. Depending on your analytical technique — LC/MS or GC/MS, identification is done by matching spectral patterns or accurate-mass molecular ions with optional retention time data against public and private spectral libraries or databases.

Mass Profiler Professional includes an integrated ID Browser that mirrors MassHunter's qualitative analysis functionality to facilitate identification using:

- LC/MS Personal Compound Databases and Libraries (METLIN, pesticides, forensics)
- GC/MS libraries (NIST and Fiehn library)
- Empirical Formula Calculation using Agilent's Molecular Formula Generator (MFG) algorithm

That means you can identify compounds quickly and easily — right within the Mass Profiler Professional environment. The software automatically annotates the entity list and projects the compound names onto any of the various visualization and pathway analysis tools.

m/z	Abund	Charge	Sat
175.119	88894	1	
176.1253	17990	1	
177.1277	2687	1	
197.101	19806	1	
387.1842	901	1	

Label	CAS	Name	Cpd	HMP	KEGG	LMP	Notes	Hits (DB)
Cpd 67: 1-Oleoyl-Lysophosphatidic acid		1-Oleoyl-Lysoph...	67	HMDB00443				
Cpd 49: 2,3-Diphospho-D-Glyceric Acid	138-81-8	2,3-Diphospho...	49				Geigy vol.3 p.112	
Cpd 1: Arginine	74-79-3	Arginine	1				Positive MS/MS	
Abund Match	CAS	Cpd ID	Name	Mass (DB)	Database Search Match Score	Formula	HMP	Identification Techni...
23.14	74-79-3	11	Arginine	174.1117	65.49	C6 H14 N4 O2		D&S
23.14		5784	D-Arginine	174.1117	65.49	C6 H14 N4 O2	HMDB03416	D&S
Label	CAS	Name	Cpd	HMP	KEGG	LMP	Notes	Hits (DB)
Cpd 59: Asp Met Asp		Asp Met Asp	59					
Cpd 41: cyclic adenosine diphosphate ribose	119340-53-2	cyclic adenosine...	41					
Cpd 2: Gly Phe Phe		Gly Phe Phe	2					
Cpd 8: Granisetron metabolite 1		Granisetron met...	8				antibiotic activit...	
Cpd 7: Hemigossypol		Hemigossypol	7	C09680		LMPR01030033		
Cpd 29: His Pro Asn		His Pro Asn	29					
Cpd 37: Hydroquinone disulfate	2458-55-1	Hydroquinone di...	37				Poison, Disinfect...	

MassHunter ID Browser identifies compounds from an entity list generated in Mass Profiler Professional. In this example, results for mass 174.1117 matched against the METLIN database reveals it to be arginine; molecular formula, database match score, name, KEGG, and CAS ID are also shown.

Pathway Architect

The Pathway Architect module of Mass Profiler Professional provides for either single omic analysis or joint analysis of multiple omics, allowing you to discover affected pathways by searching a compound list against a pathway database. The experimental data is projected onto these pathways providing you with the ability to view, zoom, filter and highlight the results. This also allows you to export a list of metabolites, proteins, transcripts and genes for pathway directed analysis.

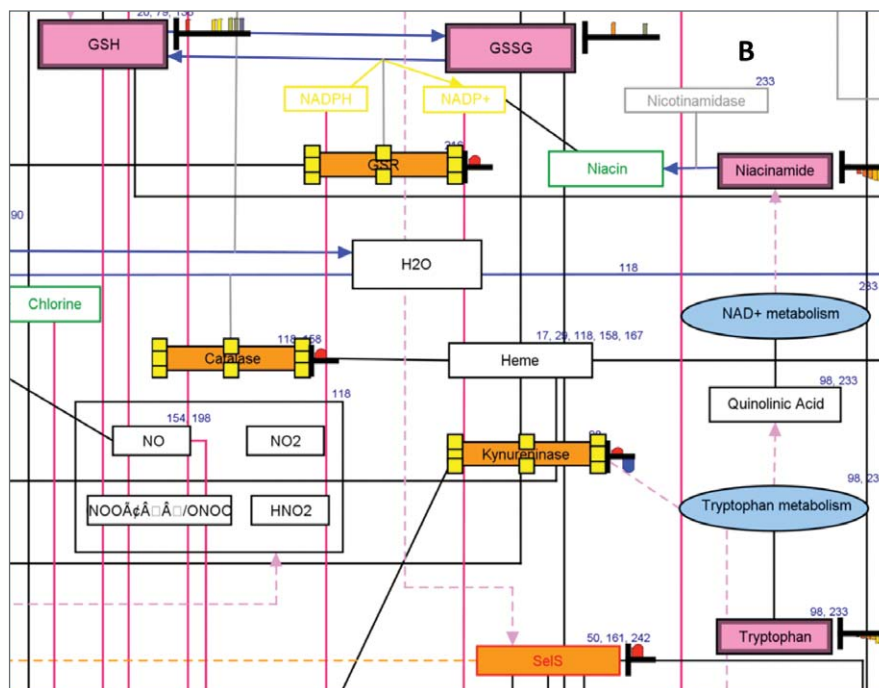

Expanded detail highlighting some of the differentially expressed metabolites and genes (yellow squares) in a pathway.

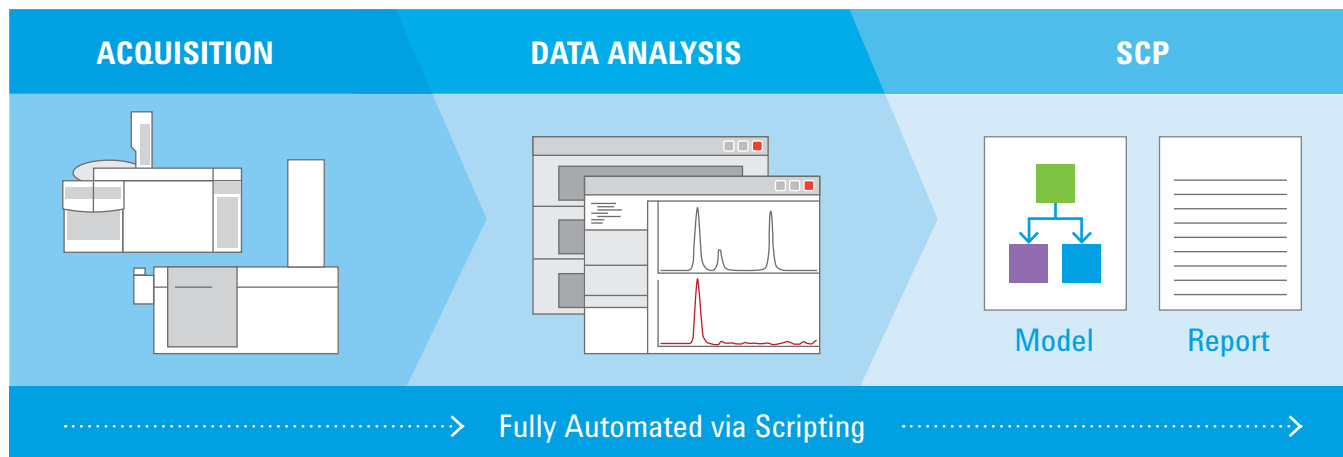

Sample Class Prediction

Mass Profiler Professional is able to create class prediction models. These models can be run using Sample Class Predictor (SCP), a stand-alone utility, with data acquired and processed in Agilent MassHunter or Agilent OpenLAB ChemStation Edition. The SCP then generates a report predicting the sample class, for example, French wine or Italian wine.

R Scripting Compatibility

You can execute R scripts within Mass Profiler Professional to further extend and customize statistical analysis and visualization capabilities.



ADD THE POWER OF CHEMOMETRIC ANALYSIS TO ANY AGILENT PLATFORM

Mass spectrometry solutions for every application

No matter which Agilent mass spectrometer you work with, Mass Profiler Professional is designed to let you take full advantage of your instrument's unique analytical capabilities. Whether your lab is analyzing biomarkers or biofuels, pesticides or petrochemicals, this software can give you the power to fully explore the relationships within your mass spectral data.

Agilent TOF and Q-TOF LC/MS

Fast acquisition speed, superior mass accuracy, and robust performance

Agilent's TOF and Q-TOF systems deliver the data quality and advanced analytical capabilities demanded of the most critical science. Using innovative Ultra High Definition Q-TOF technology, they achieve industry-leading mass accuracy, dynamic range, and sensitivity without sacrificing data acquisition speed, mass range, or mass resolution.



Agilent Triple Quadrupole LC/MS

Exceptional sensitivity and quantitative results — every day

Agilent's Triple Quadrupole LC/MS family combines exceptional analytical capabilities — including routine sub-femtogram sensitivity — with unmatched robustness and ease of operation. The ability to switch from positive ion mode to negative ion mode in 30 ms ensures full compatibility with the one second peak widths produced by UHPLC and gives greater flexibility when analyzing complex mixtures. Dynamic MRM enables the quantification of up to 4,000 compounds without time segments.





Agilent GC/MS

Industry-leading performance and productivity with maximum confidence

Based on the most popular GC/MS of all time, Agilent's latest generation GC/MSD takes detection limits lower than ever. Powerful analytical capabilities boost your lab's productivity and add confidence to your results.



Agilent Triple Quadrupole GC/MS

The world's first MS/MS specifically designed for GC

Agilent's Triple Quadrupole GC/MS delivers advanced high-speed GC/MS/MS quantitation for ultra-trace analysis of the most complex samples. Engineered for ease of use and routine high-performance operation, the triple quad analyzer perfectly complements the front-end separation capabilities of the industry-leading Agilent GC.



Agilent GC/MS Q-TOF

The first commercially available accurate mass Q-TOF

Agilent's 7200 GC/MS Q-TOF is designed specifically for classical electron impact (EI) and chemical ionization (CI) mass spectrometry. The instrument delivers high sensitivity and selectivity in full spectral mode with fast data rates and accurate mass MS/MS data to facilitate molecular characterization and structural identification.



Agilent ICP-MS

Redefines performance, reliability, and ease of use

Agilent's family of ICP-MS solutions are especially well-suited for complex sample types such as food, wastewater, and soil digests. A new collision/reaction cell and Agilent's unique High Matrix Introduction (HMI) technology combine with Agilent's proprietary Octopole Reaction System (ORS) to provide today's most reliable and effective interference removal, especially for complex and unknown sample types.

Learn more

www.agilent.com/chem/mpp

Find an Agilent customer center in your country

www.agilent.com/chem/contactus

U.S. and Canada

1-800-227-9770

agilent_inquiries@agilent.com

Europe

info_agilent@agilent.com

Asia Pacific

inquiry_lsca@agilent.com

Research use only. Information, descriptions and specifications in this publication are subject to change without notice. Agilent Technologies shall not be liable for errors contained herein or for incidental or consequential damages in connection with the furnishing, performance, or use of this material.

© Agilent Technologies, Inc. 2012
Published in the USA, April 27, 2012
5990-4164EN



Agilent Technologies