

Simultaneous high-performance and ultra-high-performance liquid chromatographic analysis of acetaminophen impurities using a single instrument

Authors

Maria Grübner, Carsten Paul,
Frank Steiner
Thermo Fisher Scientific,
Germering, Germany

Keywords

Vanquish Flex Duo UHPLC system for Dual LC, Vanquish Flex Dual Pump UHPLC, Vanquish Flex Dual Split Sampler, acetaminophen

Goal

To demonstrate the capabilities of the Thermo Scientific™ Vanquish™ Flex Duo UHPLC system for Dual LC to run independent HPLC and UHPLC methods simultaneously using one instrument.

Application benefits

- Dual LC technology provides two independent LC channels with the footprint of only one instrument.
- Established HPLC methods and their UHPLC counterparts can be implemented in parallel on the same instrument.

Introduction

In current analytical laboratories, vast numbers of analytical methods are typically established and used for the analysis of hundreds of samples. To increase throughput and generate more results, there is a growing need for faster methods as well as for additional analytical instrumentation. Thus, UHPLC-compatible instruments and spatial constraints play an increasing role in equipping these labs. In this respect, LC systems that house two independent LC channels with two separate, individually configurable, flow paths in the footprint of a single instrument are beneficial in multiple ways. For example, the newly developed Vanquish Flex Duo system for Dual LC, allows for optimization of each flow path to specific requirements, e.g. regarding extra column or gradient delay volumes, giving the opportunity to have one HPLC and one UHPLC instrument in the same stack.

Such a setup can be utilized for parallel implementation of completely independent HPLC and UHPLC methods but also for speed-up of legacy HPLC methods at the same workstation. This application demonstrates the latter case.

Here, the left chromatographic channel of the novel Vanquish Flex Duo system for Dual LC was configured with HPLC common system volumes (see instrumentation section) and was run with a 4.6 mm i.d. column with 3 μm particles for the analysis of acetaminophen as an active pharmaceutical ingredient (API) and its impurities derived from an USP assay.¹ System volumes were reduced at the right channel and the respective UHPLC counterpart method, which was created by the Thermo Scientific™ Chromeleon™ Chromatography Data System (CDS) UHPLC speed-up tool², was run in parallel with a 2.1 mm i.d. column with 1.9 μm particles.

Both analyses were performed with Thermo Scientific™ Hypersil GOLD™ C8 stationary phase of different column dimensions. Hypersil GOLD C8 matches the required USP level L7 and is well suited for analytes of medium hydrophobicity.

Experimental

Reagents and materials

- Deionized water, 18.2 M Ω ·cm resistivity or higher
- Fisher Scientific™ Optima™ Methanol, LC/MS grade (P/N 10767665)
- Fisher Scientific Sodium phosphate dibasic anhydrous (P/N 10182863)
- Fisher Scientific Potassium dihydrogen orthophosphate (P/N 10429570)
- Acetaminophen, 4-aminophenol, N-(4-hydroxyphenyl) propanamide (Impurity B), 2-acetamidophenol (Impurity C), acetanilide (Impurity D), and 4'-chloracetanilide (Impurity J) were purchased from reputable vendors.

Table 1. LC conditions.

| | Left Flow Path: HPLC | Right Flow Path: UHPLC |
|---|--|---|
| Column | Hypersil GOLD C8, 4.6 x 100 mm, 3 μm , 175 Å (P/N 25203-104630) | Hypersil GOLD C8, 2.1 x 100 mm, 1.9 μm , 175 Å (P/N 25202-102130) |
| Mobile phase | A: 1.7 g/L KH_2PO_4 and 1.8 g/L of Na_2HPO_4 in water B: Methanol | |
| Flow rate | 1 mL/min | 0.5 mL/min |
| Gradient | 0-3 min 1% B, 3-7.2 min from 1 to 85% B, 7.2-7.3 min from 85 to 1% B, 7.3-12.2 min 1% B | 0-1.25 min 1% B, 1.25-3.001 min from 1 to 85% B, 3.001-3.043 min from 85 to 1% B, 3.043-6 min 1% B or alternative 0-1.751 min from 1 to 85% B, 1.751-1.792 min from 85 to 1% B, 1.792-4.8 min 1% B |
| Mixer volume (static + capillary mixer) | (350+50) μL | (150+50) μL |
| Column temperature | 35 °C (Still air mode) with active pre-heater | |
| Autosampler temperature | 8 °C | |
| UV wavelength | 230 nm | |
| UV data collection rate | 10 Hz | 20 Hz |
| UV response time | 0.5 s | 0.2 s |
| Injection volume | 1 μL | 0.17 μL or alternative 0.5 μL |
| Needle wash | Off | |

Sample preparation

Stock solutions of acetaminophen (20 mg/mL), 4-aminophenol and the impurities B, C, D, and J (1 mg/mL each) were prepared in methanol. By dilution with methanol and mixing of stock solutions, a sample was prepared that contained 10 mg/mL acetaminophen and 10 µg/mL of each of the other compounds (corresponding to 0.1% of the API).

Instrumentation

Vanquish Flex Duo system for Dual LC consisting of:

- System Base Vanquish Dual (P/N VF-S02-A-02)
- Dual Pump F (P/N VF-P32-A-010)
- Left pump with Static mixer, volume 350 µL (P/N 6044.5310)
- Right pump with Static mixer, volume 150 µL (P/N 6044.5110)
- Dual Split Sampler FT (P/N VF-A40-A-020)
- Column Compartment H (P/N VH-C10-A-020)
- Variable Wavelength Detector at left flow path (P/N VH-D40-A0)
 - With Standard flow cell, 10 mm, 11 µL (P/N 6077.0250)
- Variable Wavelength Detector at right flow path (P/N VH-D40-A0)
 - With Semi-micro flow cell, 7 mm, 2.5 µL (P/N 6077.0360)

Data processing and software

Chromeleon CDS software version 7.2.8 was used for data acquisition and analysis.

Results and discussion

Figure 1 illustrates the schematic fluidic setup of the Dual LC system used in this study.

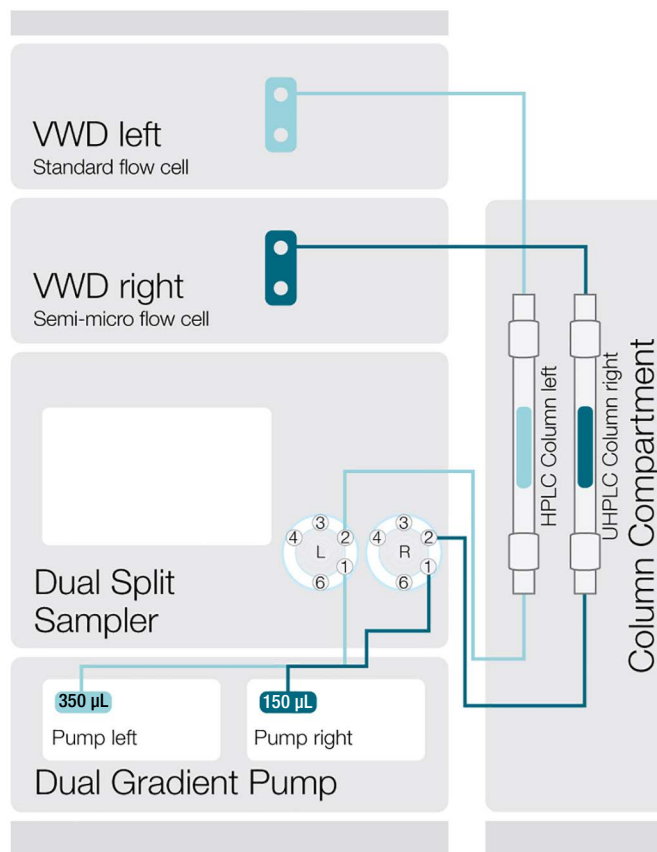

Figure 1. Fluidic setup of Vanquish Flex Duo system for Dual LC with one HPLC (light blue) and one UHPLC (dark blue) flow path.

The method parameters of the UHPLC channel of this experiment were derived from the original HPLC method by the Chromeleon CDS UHPLC speed-up tool with a boost factor of 1.52 for a flow rate of 0.5 mL/min and additional flush time to ensure sufficient equilibration. Both chromatographic channels were run with 10 repeated injections of the prepared sample. Figure 2 shows two example chromatograms with average resolutions (R_s) that easily meet the USP requirements.¹ Table 2 summarizes the retention times (t_R) and their precision. The absolute and relative standard deviations (SD and %RSD) of retention times are comparable for both methods.

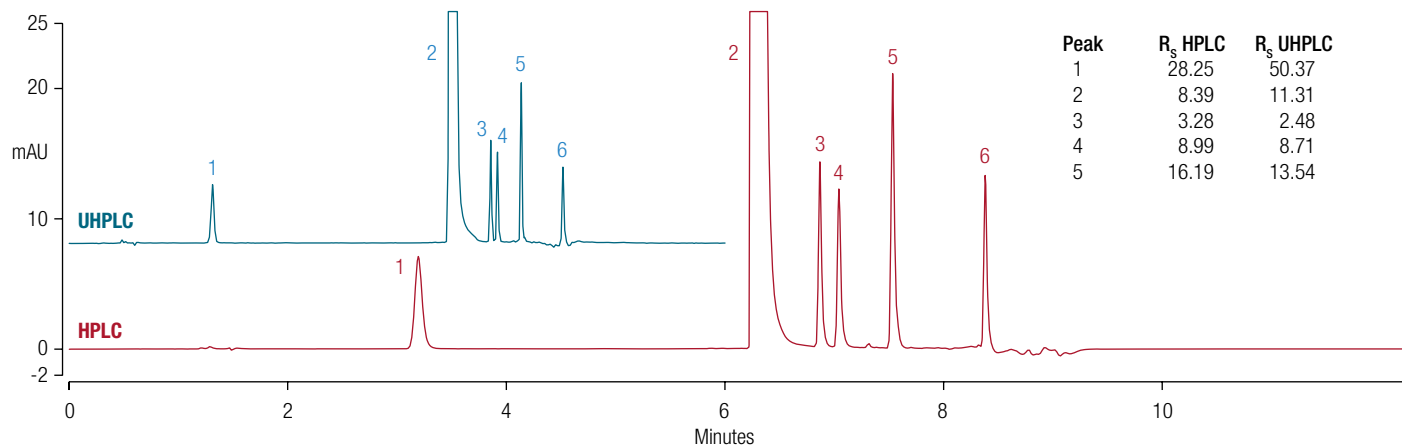

Figure 2. Chromatograms of HPLC (bottom, red) and UHPLC (top, blue) run at same time and signal scale and peak resolutions. For peak assignment see Table 2.

Table 2. Retention times (t_R) and standard deviation (SD) and relative standard deviations (%RSD) for HPLC and UHPLC analysis.

| Peak # | Compound | HPLC Method | | | UHPLC Method | | |
|--------|---------------|-------------|----------------|------------|--------------|----------------|------------|
| | | t_R [min] | t_R SD [min] | t_R %RSD | t_R [min] | t_R SD [min] | t_R %RSD |
| 1 | 4-Aminophenol | 3.195 | 0.002 | 0.058 | 1.313 | 0.001 | 0.034 |
| 2 | Acetaminophen | 6.261 | 0.001 | 0.018 | 3.498 | 0.001 | 0.046 |
| 3 | Impurity B | 6.868 | 0.001 | 0.017 | 3.858 | 0.001 | 0.015 |
| 4 | Impurity C | 7.042 | 0.001 | 0.018 | 3.919 | 0.001 | 0.014 |
| 5 | Impurity D | 7.534 | 0.001 | 0.020 | 4.136 | 0.001 | 0.015 |
| 6 | Impurity J | 8.382 | 0.002 | 0.019 | 4.519 | 0.001 | 0.017 |

Regarding peak area precision and signal-to-noise values (S/N), the UHPLC method was inferior to the HPLC method due to two impacts (see Figure 3, blue and red bars). For one, UV sensitivity is affected by the length of the light path provided by the flow cell, which is 30% shorter for the UHPLC setup. Furthermore, injection precision (and thus area %RSD) is negatively affected by the very low injection volume of 0.17 μL in the UHPLC method as it comes closer to the autosampler's specification limit. Due to downscaling to the smaller UHPLC column volume, this small injection volume results from automatic parameter calculation by the Chromeleon CDS speed-up calculator originating from an already small injection volume of just 1 μL that had to be applied in the original HPLC method. In HPLC mode, analysis volumes greater than 1 μL caused distorted peak shapes for the early eluting 4-aminophenol because

of the high elution strength of the sample solvent methanol and insufficient pre-column mixing in the low system volumes. In contrast to a fronting peak shape in HPLC for injection of 3 μL , an equivalent triplication of the downscaled injection volume did not cause any peak disturbance for the UHPLC method as the sample volume of 0.5 μL is small enough to be adequately mixed with the surrounding mobile phase before entering the column. Both cases are illustrated in Figure 4 and clearly demonstrate the advantage of the UHPLC method for sample volume loading capacity. Thus, a simple improvement of the UHPLC method by increasing the injection volume from 0.17 μL to 0.5 μL is recommended to improve S/N and yield area %RSDs in a similar range as the HPLC method, which is also depicted in Figure 3, yellow bars. However, all three methods resulted in well integrable peaks with S/N values all greater than 50.

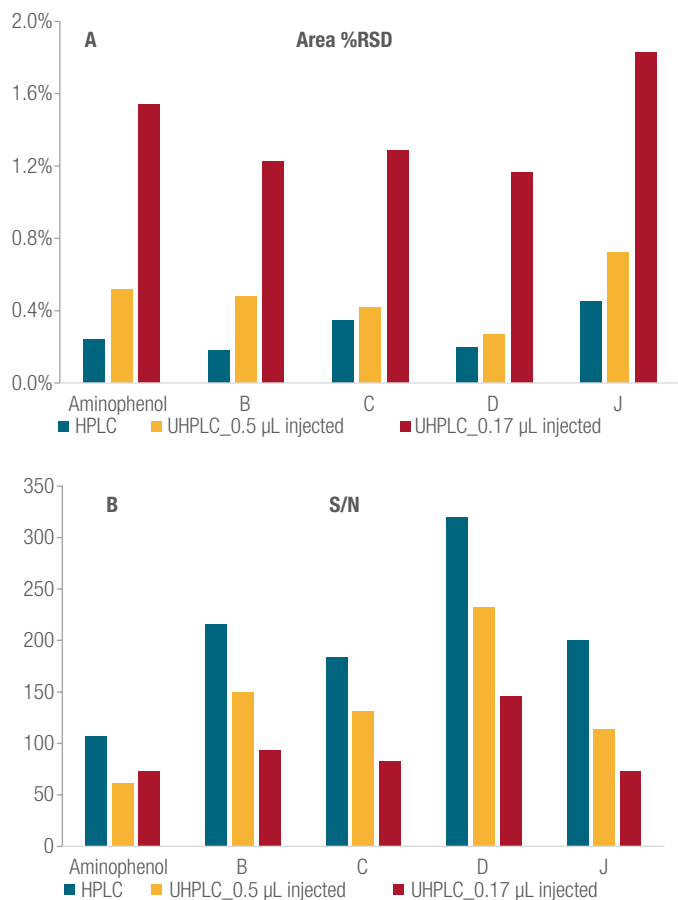

Figure 3. Area precision (A) and signal-to-noise values (B) for HPLC with 1 μ L and UHPLC with 0.17 μ L and 0.5 μ L injection volume for acetaminophen impurities.

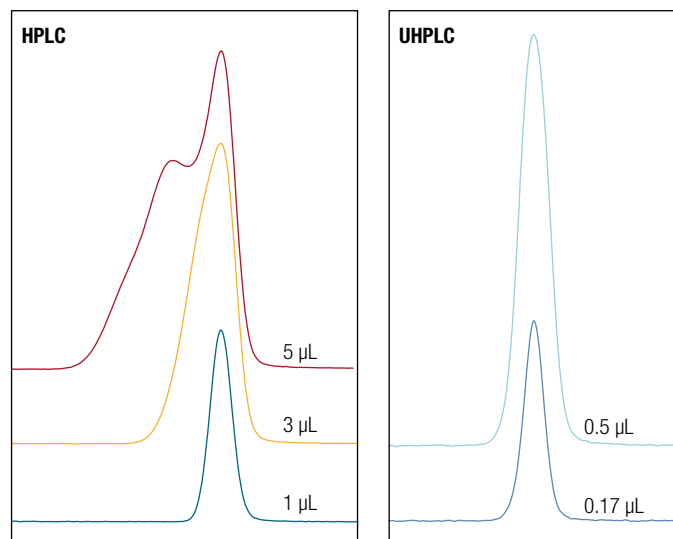

Figure 4. 4-Aminophenol peak depending on injection volume in both assays. Injecting the threefold volume in HPLC already causes peak fronting. In UHPLC, the peak shape is not affected.

Considerable benefits of the UHPLC method are substantial savings in sample volume, solvent consumption, and cycle time (t_c), with additional optimization capabilities if the gradient delay volume and thus equilibration time were further reduced, for example by configuring the Dual LC system with a high-pressure mixing pump (HPG) for the UHPLC path. Another option to increase throughput and save costs and time is the elimination of the first isocratic step from the gradient table, as the column experiences a sufficiently long isocratic step due to gradient delay. The respective UHPLC chromatograms are depicted in Figure 5, and it can be deduced that the resolution of the critical pair (peak 3 and 4) is improved ($R_s=3$). With this method the run time could be shortened by another 1.2 min without compromising area %RSDs or S/N (see Figure 6).

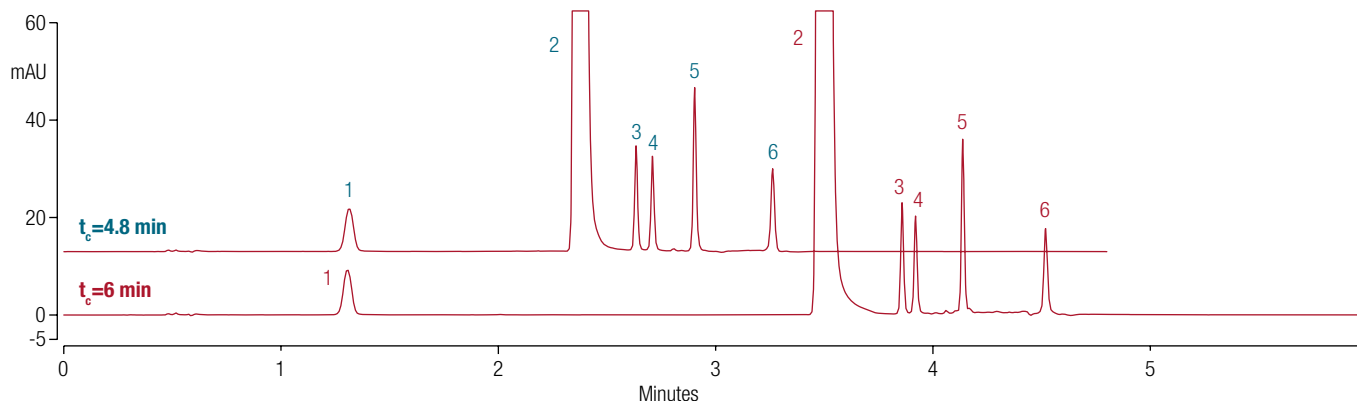

Figure 5. Chromatograms of UHPLC runs with (bottom) and without (top) programmed isocratic start at same time and signal scale. Injection volume was 0.5 μ L. For peak assignment see Table 2.

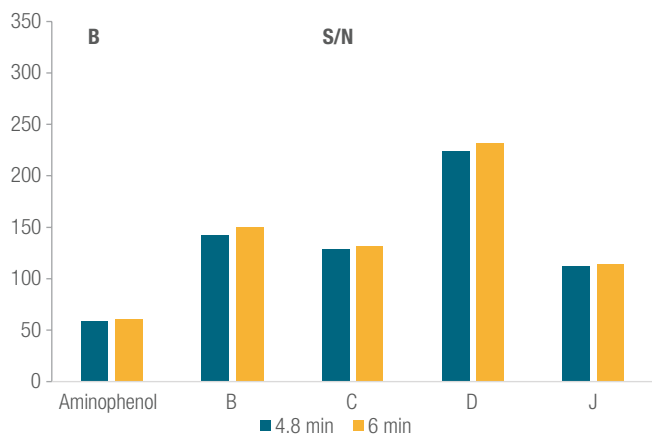
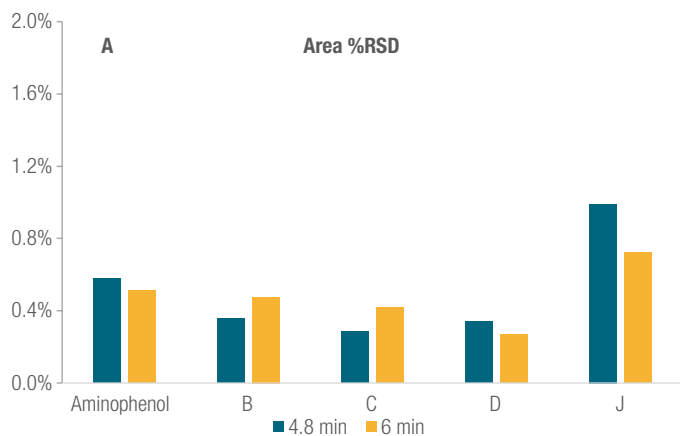

Figure 6. Area precision (A) and signal-to-noise values (B) for UHPLC analysis with 0.5 μ L injection volume and 4.8 min cycle time without isocratic step or 6 min cycle time with isocratic step.

Compared to the HPLC analysis, the optimized UHPLC method (without isocratic step, injection volume 0.5 μ L) resulted in 50% sample, 80% solvent, and 60% time savings and a 2.5-fold throughput improvement (Figure 7). One hundred samples could be analyzed during an 8 h working day by UHPLC instead of more than 20 h. Assuming costs of \$25 per liter of solvent plus 10% for disposal, switching to UHPLC implies cost savings of around \$27 per 100 samples or \$5400 per year (with an estimation of 20,000 samples per year).

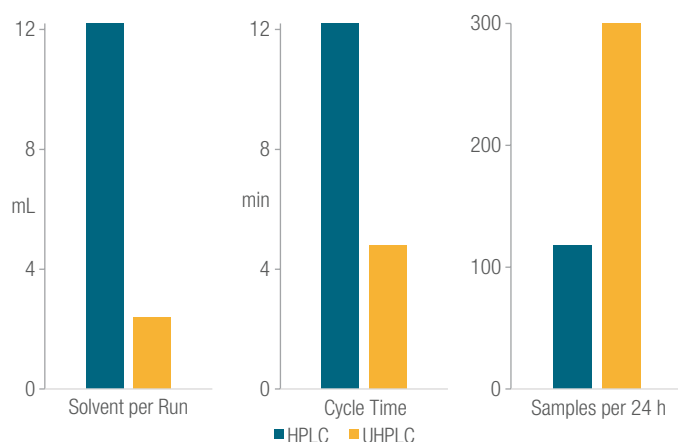

Figure 7. Comparison of the HPLC method and the most-optimized UHPLC method (without an isocratic step and injection volume of 0.5 μ L) regarding throughput, solvent, and time expenses.

Conclusion

- The Vanquish Flex Duo system for Dual LC provides the opportunity to have one HPLC and one UHPLC channel in a single system stack, both working independently from each other.
- Speed-up of legacy HPLC methods to fast UHPLC methods can be easily conducted at the same workstation. Both channels can also be used independently for separate analyses.
- In the current study, a 2.5-fold throughput increase and savings of up to 80% mobile phase and 60% cycle time were achieved by speeding up a HPLC method to UHPLC conditions.

References

1. United States Pharmacopeia USP40-NF35 S1, Acetaminophen method, The United States Pharmacopeial Convention, 2017.
2. Franz, H.; Fabel, S.: Thermo Fisher Scientific Technical Note 75: A Universal Tool for Method Transfer From HPLC to UHPLC, 2016, <https://assets.thermofisher.com/TFS-Assets/CMD/Application-Notes/TN-75-HPLC-UHPLC-Universal-Tool-Method-Transfer-TN70828-EN.pdf> (accessed December 5, 2017).

For Research Use Only. Not for use in diagnostic procedures.

Find out more at [thermofisher.com/VanquishDuo](https://www.thermofisher.com/VanquishDuo)

ThermoFisher
SCIENTIFIC