

Thermo Scientific™ Orbitrap™ Tribrid™ MS Series: Instrument Control Software v.3.5 and v3.5 SP1 Overview

January-2022

 The world leader in serving science

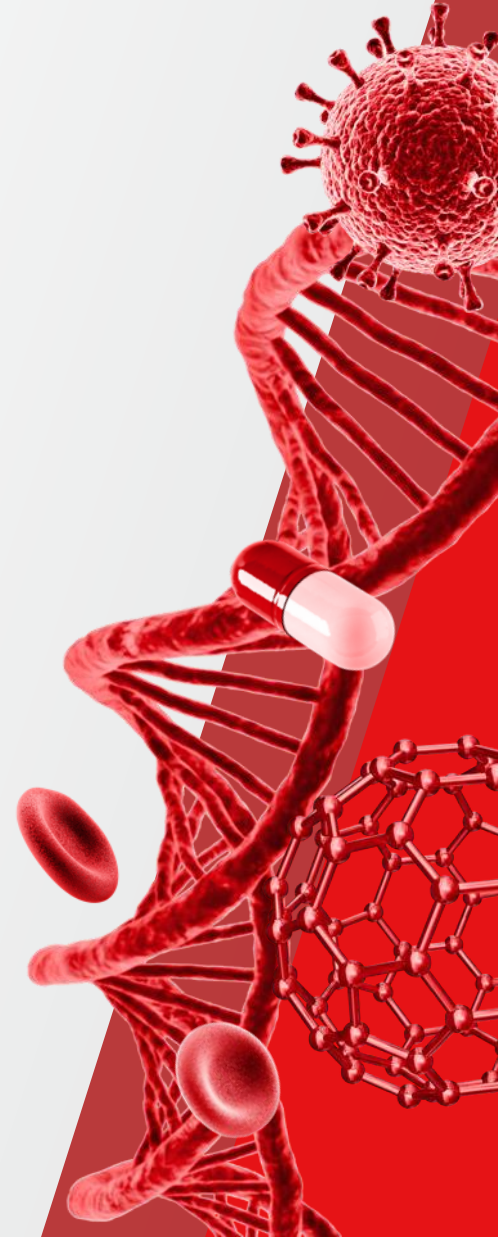

Flexera

Download: [Orbitrap Tribrid MS Series ICSW v. 3.5 SP1 and Xcalibur 4.5 Software](#)

thermo scientific

Life Sciences Mass Spectrometry
Software Download and Licensing Portal

Home

Software & Services

- Product List
- Product Search
- Order History
- Search Line Items
- Files Not Downloaded
- Recent Product Releases
- Recent Files
- Recent Emails

Licensing

- Search Licenses
- Offline Activation
- Download Activation Codes

Administration

- Account Members
- Join Account
- Change Password
- Email Preferences
- Product Preferences
- Download Preferences
- Your Profile

Information

- FAQs
- ESDM User Manual
- Support

Sessions

- Switch Account
- Logout

Product Download

Orbitrap Tribrid Series 3.5 SP1

[Download Help](#)

The software you are about to download is subject to export control laws and regulations. By downloading this software, you agree that you will not knowingly, without prior written authorization from the competent government authorities, export or reexport - directly or indirectly - any software downloaded from this website to any prohibited destination, end-user, or end-use.

5 Files

File Description	File Size	File Name
+ LC Devices 3.2 SP2	2.1 GB	LC Devices 3.2 SP2.zip
+ LC Devices 3.2 SP3	1.9 GB	LC Devices 3.2 SP3.zip
+ Orbitrap Tribrid Series 3.5 SP1	1.6 GB	Orbitrap Tribrid Series v3.5.3886.0.SP1.zip
+ SII for Xcalibur 1.6	4.7 GB	SII\Xcalibur-Full-1.6.0.60983-381aca7bd37ac8ace7a71d644ab687251de41d60.en-US.Release.SII.Xcalibur.Setup.iso
+ Xcalibur 4.5	1.1 GB	Xcalibur 4.5.zip

© Copyright 2022 Thermo Fisher Scientific Inc. All rights reserved. [Privacy Statement](#) | [Terms and Conditions](#) | [Site Map](#) |

Thermofisher.com & AnalyteGuru

Learn more about LC-MS Data Acquisition software

You can use the instrument control software to collect high-quality mass spectrometry data on the Thermo Scientific mass spectrometers. Control of the instruments is through two application packages: Tune and Method Editor.

For questions about the software, to request features, or to report defects, send an email by clicking [here](#).

Orbitrap Tribrid MS series | **Orbitrap Exploris MS series** | Exactive MS Series

Orbitrap Tribrid MS series instrument control software version 3.5

Release date	Build number	Instruments	Software requirements
July 20, 2020	3.5.3881.18	Orbitrap Eclipse Tribrid MS, Orbitrap Fusion Lumos Tribrid MS, Orbitrap IQ-X Tribrid MS, Orbitrap ID-X Tribrid MS	Xcalibur 4.3 or later (use 4.5 for the latest AcquireX features). Note, use of Orbitrap Tribrid MS series 3.5 requires Windows 10.

Follow the upgrade instructions provided: Orbitrap Tribrid MS series ICSW v. 3.5 [Release notes](#) >
 Orbitrap Tribrid MS series ICSW v. 3.5 and Xcalibur 4.5 software: [Download the software](#) >
 Orbitrap Tribrid MS series ICSW v.3.5 Overview: [Download the update overview](#) >

New features

The Orbitrap Tribrid MS series instrument control software version 3.5 incorporates the following new and improved features

- Support for the Orbitrap IQ-X Tribrid MS mass spectrometer
- (Orbitrap IQ-X Tribrid MS and Orbitrap Eclipse Tribrid MS small molecule application mode only) Support for Real-Time Library Search, facilitating decision-based triggering of MSn scan events in small molecule applications
- (Orbitrap IQ-X Tribrid MS only) Support for Auto-Ready ion source, enabling automated and remote calibration

- Updates: [AnalyteGuru.com](https://www.analyteguru.com)
 To receive focused updates, subscribe to the pertinent labels (e.g., *Orbitrap Tribrid MS Instrument Control Software*)

AnalyteGuru > Knowledgebase > Scientific Library > Orbitrap Tribrid MS Series Instrument Control Soft... Options

Orbitrap Tribrid MS Series Instrument Control Software Version 3.5

Sebastien
Team TFS

Tuesday - edited Thursday by **Molly_I2**
Community Manager

Version history

Last update: Thursday

Updated by: **Molly_I2**
Community Manager

On July 21, 2021, version 3.5 of the Orbitrap Tribrid MS Series Instrument Control Software was released. It supports Orbitrap Eclipse, Orbitrap Fusion, Orbitrap Fusion Lumos, Orbitrap ID-X, and Orbitrap IQ-X MS systems.

Visit our [LC-MS Data Acquisition Software page](#) to download the software and learn more.

Orbitrap Tribrid | **Orbitrap Tribrid MS Instrument Control Software** | Software

- Information: [Thermofisher.com](https://www.thermofisher.com)
 - Software information
 - Links for download
 - New Features
 - Known Issues
 - Discovered issues
 - Fixed Defects

Orbitrap Tribrid Series Instrument Control Software v 3.5

Orbitrap ID-X, Orbitrap Fusion, Orbitrap Fusion Lumos, and Orbitrap Eclipse MS Systems



Thermo Scientific™
Orbitrap ID-X™ MS



Thermo Scientific™
Orbitrap Fusion™ MS



Thermo Scientific™
Orbitrap Fusion™ Lumos™ MS



Thermo Scientific™
Orbitrap Eclipse™ MS

Orbitrap Tribrid Series Instrument Control Software v 3.5

Orbitrap IQ-X Equipped with Auto-Ready Ion Source, FAIMS Pro Duo Interface



FAIMS Pro Duo Interface



Auto-Ready Ion Source

Thermo Scientific™ Orbitrap IQ-X™ Tribrid™ Mass Spectrometer

New Features And Usability Enhancements Summary

Orbitrap Tribrid Series Instrument Control 3.5 and 3.5 SP1

- Support for the Orbitrap IQ-X mass spectrometer
- Orbitrap IQ-X and Eclipse (small molecule mode) - Support for Real-Time Library Search
- Xcalibur 4.5 - Support for new AcquireX workflow and more flexible parameter settings
- Orbitrap IQ-X - Support for Auto-Ready ion source
- Support for FAIMS Pro Duo Interface
- Optimized FAIMS CV post-switching delay time
- Total Carrier Gas Flow succeeds FAIMS User Gas to enable lower flow rates for improved nanospray stability
- Advanced Peak Determination (APD) is now standard for all Orbitrap Tribrid products and benefits from application mode specific optimization
- Support for Extended low mass range m/z 40 in MS_n scans
- Mild Trapping option available to reduce MS_1 fragmentation of labile compounds
- Usability enhancements
 - Support for absolute and normalized HCD collision energies
 - Support for target specific HCD collision energy in Targeted Mass Filter Table
- Support for Chromeleon



Orbitrap Tribrid™ Series 3.5

Instrument Control Software

thermo
scientific

Support for Real-Time Library Search

Real-time Acquisition Decisions for Improved Structure Elucidation of Small Molecules

- Challenge
 - Elucidation of chemical structures is one of the most difficult challenges in analytical chemistry
 - MS2 is often insufficient for structure assignment
 - MSn can help, but requires experience to set up
- Solution
 - On-the-fly MS2 spectral matching against custom mzVault libraries or local copies of mzCloud libraries for decision-based triggering of MSn scan events
- Availability
 - Orbitrap IQ-X
 - Orbitrap Eclipse (small molecule application mode)

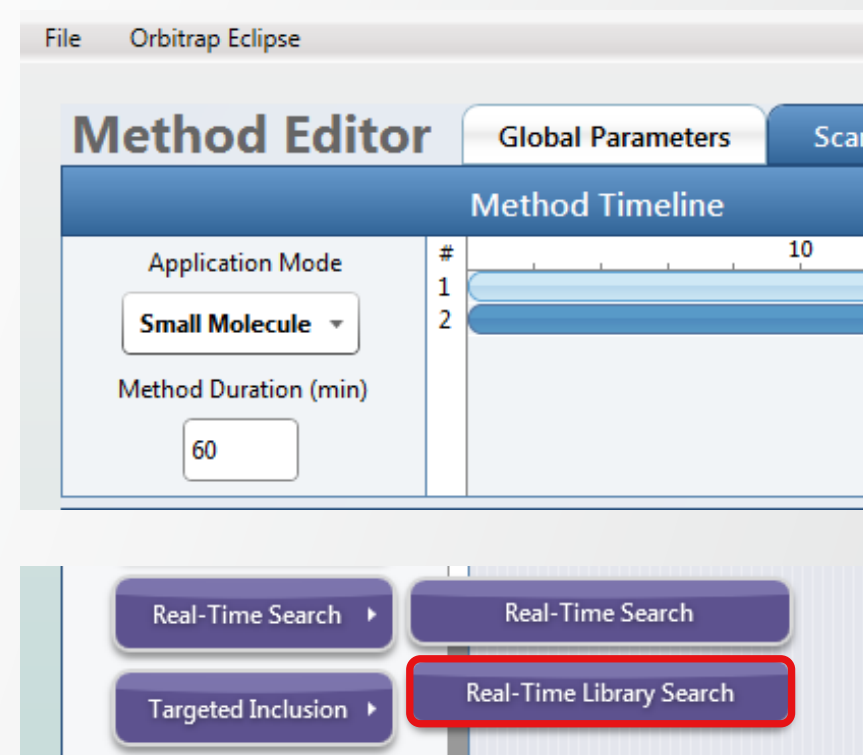

Support for Real-Time Library Search

Background Services & Communication

- Glutamate backend service used to process each generated MS2 scan
- Search results returned based on RTLS filter parameters
- Triggering of MS_n scan events according to search results, method scheme, and filter thresholds

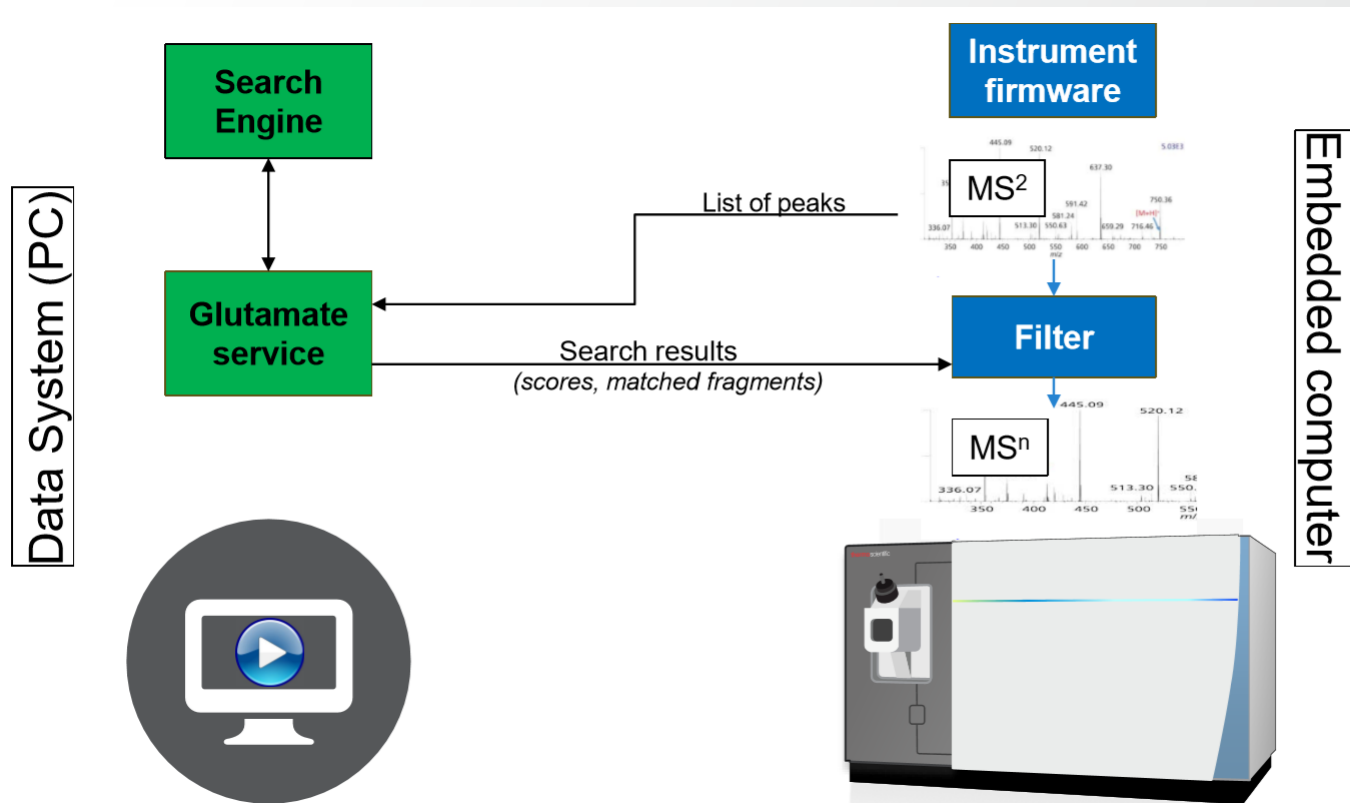

Embedded computer

Data System (PC)

Support for Real-Time Library Search

Filter Overview

- Two sections of RTLS filter properties
 - Global parameters (A)
 - Filter instance specific “Extended Properties” (B)
- Global parameters (A)
 - Synchronized across all instances of the filter
 - Impact general search behaviors
- Extended properties (B)
 - Filter instance specific within the method decision tree
 - Controlled independently for each filter and can lead to specific outcomes and complex decisions

Real-Time Library Search Properties

(A) Spectral Library: mzVault_Library.db
 Browse Clear
 Collision Energy Tolerance: 15
 Precursor Search Tolerance (ppm): 10

Adduct Masses ADD DELETE IMPORT EXPORT

	Adduct Molecular Species	Charge	
1	M	0	

Maximum Search Time (ms): 150

(B) EXTENDED PROPERTIES...

Use as a Trigger Only
 Add Adducts to Dynamic Exclusion

Scoring Thresholds ADD DELETE IMPORT EXPORT

	Score Type	Filter By	Score	
1	Confidence Score	At least	0	

Compound Class Filter ADD DELETE IMPORT EXPORT

	Keyword	Promote/Reject

Support for Real-Time Library Search

Configurable (Global) Parameters within RTLS Filter

- Spectral Library **1**
 - Reference to a path on disk – library not embedded in .meth file
 - Custom mzVault spectral libraries or local copies of mzCloud MS2 libraries (in .db format)
- Collision Energy Tolerance **2**
 - +/- value for filtering the spectral library candidates during search
 - Applies to the MS2 event preceding RTLS placement
- Precursor Search Tolerance (ppm) **3**
 - In ppm, +/- value for filtering the spectral library candidates during search
 - Applies to the MS2 event preceding RTLS placement

Real-Time Library Search Properties

1 Spectral Library

2 Collision Energy Tolerance

3 Precursor Search Tolerance (ppm)

Adduct Masses

	Adduct Molecular Species	Charge	
1	M	0	

Maximum Search Time (ms)

EXTENDED PROPERTIES...

Use as a Trigger Only

Add Adducts to Dynamic Exclusion

Scoring Thresholds

	Score Type	Filter By	Score	
1	Confidence Score	At least	0	

Compound Class Filter

	Keyword	Promote/Reject	
--	---------	----------------	--

Support for Real-Time Library Search

Configurable (Global) Parameters within RTLS Filter

- Adduct Masses (settings) 4
 - Adduct Offset Query functionality may help to identify adducted compounds if an entry does not exist for that molecular species in the database.
 - Prepopulated list of adduct ions from Compound Discoverer
 - When selected, auto-populates with default charge state for consideration (but is user editable)
 - Adducts can be limited to a single charge state or applied to all charges (give 0 as charge state)

Real-Time Library Search Properties

Spectral Library: mzVault_Library.db
Browse Clear

Collision Energy Tolerance: 15
Precursor Search Tolerance (ppm): 10

4 Adduct Masses ADD DELETE IMPORT EXPORT

	Adduct Molecular Species	Charge
1	M	0

150

PROPERTIES...

DELETED IMPORT EXPORT

Score: 0

Compound Class Filter ADD DELETE IMPORT EXPORT

Keyword	Promote/Reject
---------	----------------

Support for Real-Time Library Search

Configurable (Global) Parameters within RTLS Filter

- Special Adduct Masses (definition) 4
 - “M” – this is equivalent to $[M+zH]^{z+}$ or $[M-zH]^{z-}$
 - “M” at Charge “0” would apply to protonated and deprotonated forms across all charge states
- Adduct Masses Validation
 - Duplicate adducts are allowed at different charge states (warning displayed if full duplication)
 - Adduct at all charges (Charge “0”) will give warning if same adduct is added at a specific charge
 - Warning displayed if a charge is entered not matching the settings of “Charge State” filter (possibly included upstream in the method branch)

Real-Time Library Search Properties

Spectral Library:

Collision Energy Tolerance:

Precursor Search Tolerance (ppm):

4 Adduct Masses

	Adduct Molecular Species	Charge	
1	M	0	

Maximum Search Time (ms):

EXTENDED PROPERTIES...

Use as a Trigger Only:

Add Adducts to Dynamic Exclusion:

Scoring Thresholds

	Score Type	Filter By	Score	
1	Confidence Score	At least	0	

Compound Class Filter

	Keyword	Promote/Reject	
--	---------	----------------	--

Support for Real-Time Library Search

Configurable (Global) Parameters within RTLS Filter

- Maximum Search Time (ms) **5**
 - Searches are executed serially and can abort after user defined duration is expired (returning empty results)
 - Normal instrument acquisition continues even while searches are executing

Real-Time Library Search Properties

Spectral Library:

Collision Energy Tolerance:

Precursor Search Tolerance (ppm):

Adduct Masses

	Adduct Molecular Species	Charge	
1	M	0	

5 Maximum Search Time (ms):

EXTENDED PROPERTIES...

Use as a Trigger Only:

Add Adducts to Dynamic Exclusion:

Scoring Thresholds

	Score Type	Filter By	Score	
1	Confidence Score	At least	0	

Compound Class Filter

	Keyword	Promote/Reject
--	---------	----------------

Support for Real-Time Library Search

Configurable Parameters within Extended Properties Section

- Use as a Trigger Only 1
 - When enabled, pass **all peaks** (whole spectrum) for next scan
 - When disabled, pass only **matched peaks** for next scan
- Add Adducts to Dynamic Exclusion 2
 - When the scoring thresholds (below) are satisfied, if this option is enabled, the calculated hypothetical adducted m/z values are added to dynamic exclusion

(Note: Monoisotopic peak and 3x C13 isotopic peaks are considered, regardless of the elemental composition of the analyte identified)

 - The duration and m/z tolerance of the dynamic exclusion is taken from the dynamic exclusion filter of the method as defined by the user

Real-Time Library Search Properties

Spectral Library:

Collision Energy Tolerance:

Precursor Search Tolerance (ppm):

Adduct Masses

	Adduct Molecular Species	Charge
1	M	0

Maximum Search Time (ms):

EXTENDED PROPERTIES...

- 1 Use as a Trigger Only
- 2 Add Adducts to Dynamic Exclusion

Scoring Thresholds

	Score Type	Filter By	Score
1	Confidence Score	At least	0

Compound Class Filter

	Keyword	Promote/Reject
--	---------	----------------

Support for Real-Time Library Search

Configurable Parameters within Extended Properties Section

- Scoring Thresholds 3
 - Two HighChem scores exposed: Cosine Score & Confidence Score
 - Delta scores between the 1st and 2nd best hit
 - Score thresholds can be set to require a minimum (“At least”, \geq) or a maximum value (“Less than”, $<$)
 - Thresholds are separately configured for each instance of RTLS filter and can lead to different scan outcomes
 - Duplicated score thresholds trigger a validation error

Real-Time Library Search Properties

Spectral Library: mzVault_Library.db
Browse Clear

Collision Energy Tolerance: 15
Precursor Search Tolerance (ppm): 10

Adduct Masses: ADD DELETE IMPORT EXPORT

	Adduct Molecular Species	Charge
1	M	0

Maximum Search Time (ms): 150

EXTENDED PROPERTIES...

Use as a Trigger Only

Add Adducts to Dynamic Exclusion

3 Scoring Thresholds: ADD DELETE IMPORT EXPORT

	Score Type	Filter By	Score
1	Cosine Score	At least	10

Compound Class Filter: ADD DELETE IMPORT EXPORT

	Keyword	Promote/Reject
--	---------	----------------

Support for Real-Time Library Search

Configurable Parameters within Extended Properties Section

- Compound Class Filter 4
 - Promote/Reject specific compound classes based on keyword
 - Compound class annotation can be defined within mzVault library management application
 - Like for the standard peptide RTS filter, the Compound Class Filter items which are “promoted” or “rejected” will override the user defined thresholds
 - If a scan top hit does not meet thresholds, but is promoted by the compound class filter, it will continue
 - If a scan’s top hit does meet thresholds, but is rejected by the compound class filter, it will not continue

Formula	CAS ID	InChi Key	Compound Class
C8H9NO4	82826		Endogenous Metabolites
C7H8N4O2	58559		Endogenous Metabolites Therapeutics/Prescription Drugs
C73H108O12	6683198		Industrial Chemicals



Spectral Library: mzVault_Library.db

Collision Energy Tolerance: 15

Precursor Search Tolerance (ppm): 10

ADDUCT MASSES

Adduct Molecular Species	Charge
1 M	0

Maximum Search Time (ms): 150

EXTENDED PROPERTIES...

Use as a Trigger Only

Add Adducts to Dynamic Exclusion

SCORING THRESHOLDS

Score Type	Filter By	Score
1 Cosine Score	At least	10
Confidence Score	At least	
Confidence Delta Score	Less than	
Cosine Score		
Cosine Delta Score		

4 Compound Class Filter

Keyword	Promote/Reject
	Promote
	Promote
	Reject

Support for Real-Time Library Search

RTLS Filter Placement Constraints

- RTLS filters can only be placed under a single MS2 node, but can be present in multiple copies.
- RTLS currently supports a single polarity per method
- RTLS currently cannot be placed after a tMSn node

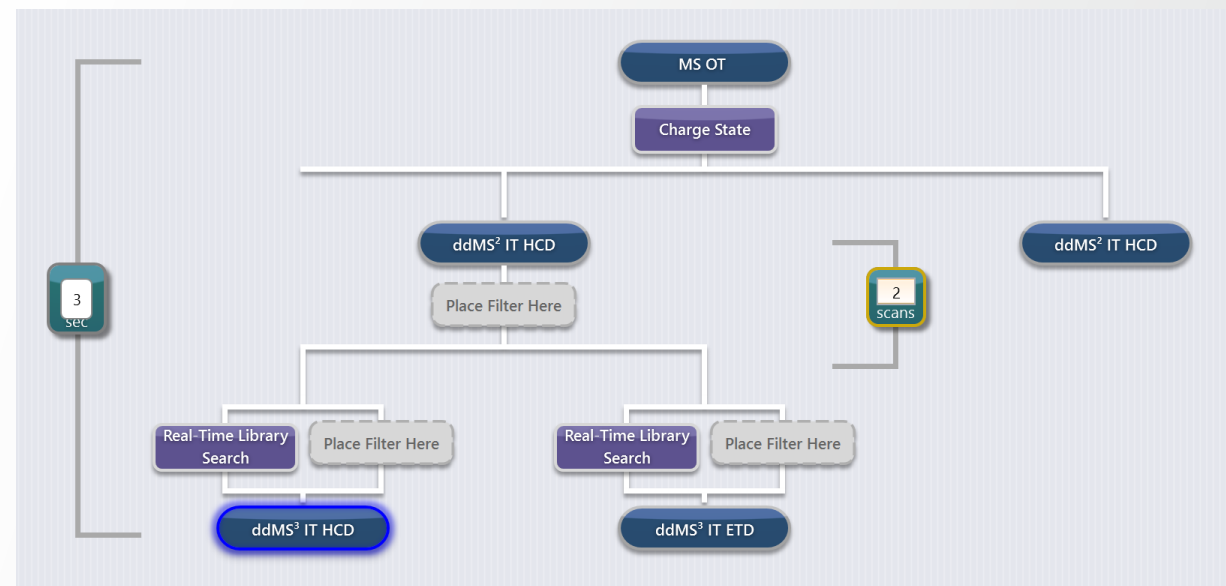

Real-Time Library Search – Based Acquisition Method

Application: MET-IQ - Intelligent mass spectrometry for small molecules

- Identification and characterization of unknown compounds, chemically similar to known compounds of interest
- Metabolomics applications, identification of various environmental contaminants, unknown extractables and leachables as well as emerging clinical toxins

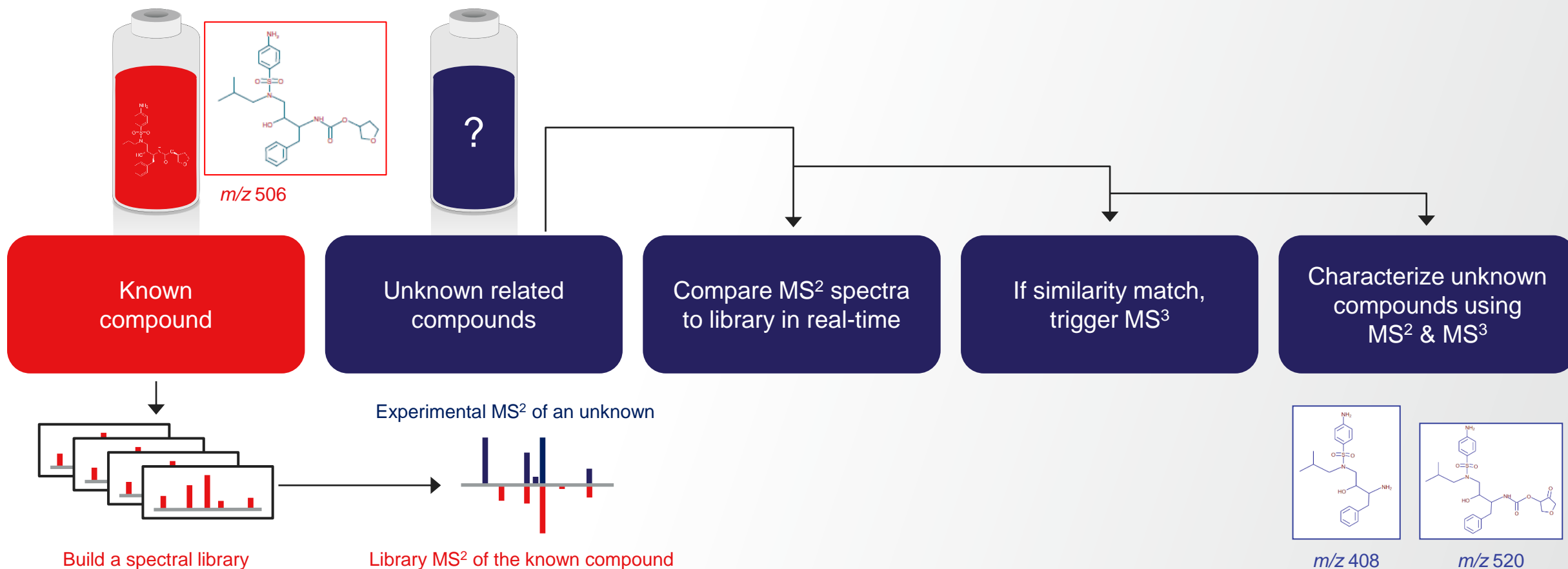

Real-Time Library Search – Based Acquisition Method

Application: MET-IQ - Intelligent mass spectrometry for small molecules

- Identification and characterization of unknown compounds, chemically similar to known compounds of interest
- Metabolomics applications, identification of various environmental contaminants, unknown extractables and leachables as well as emerging clinical toxins

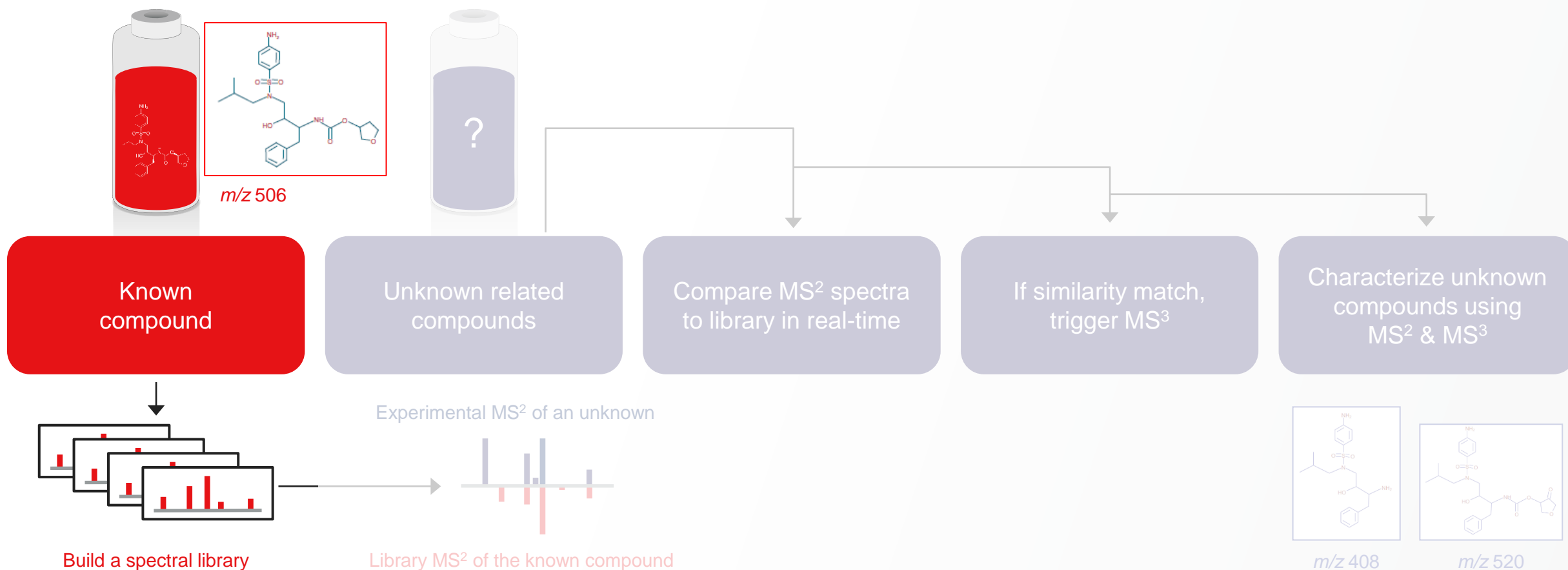

Real-Time Library Search – Based Acquisition Method

Generation of Spectral Libraries for known compounds

- Build a new method from the new preset MS/MS Library Builder template to create the spectral library for the compound of interest
 - Analyses are performed as direct infusion or with an LC method (with the need for chrom. peak $\geq 6s$)
 - M/z value (or m/z & z) of the compound of interest are included in Targeted Mass filter
 - MS/MS acquisition is performed with HCD at nCE 10,20, 30,..., 80 and with CID at nCE 15, 30, and 45 (11 total MS2 scan events)
- Data are processed with mzVault (can be downloaded from <https://thermo.fexnetoperations.com/>)

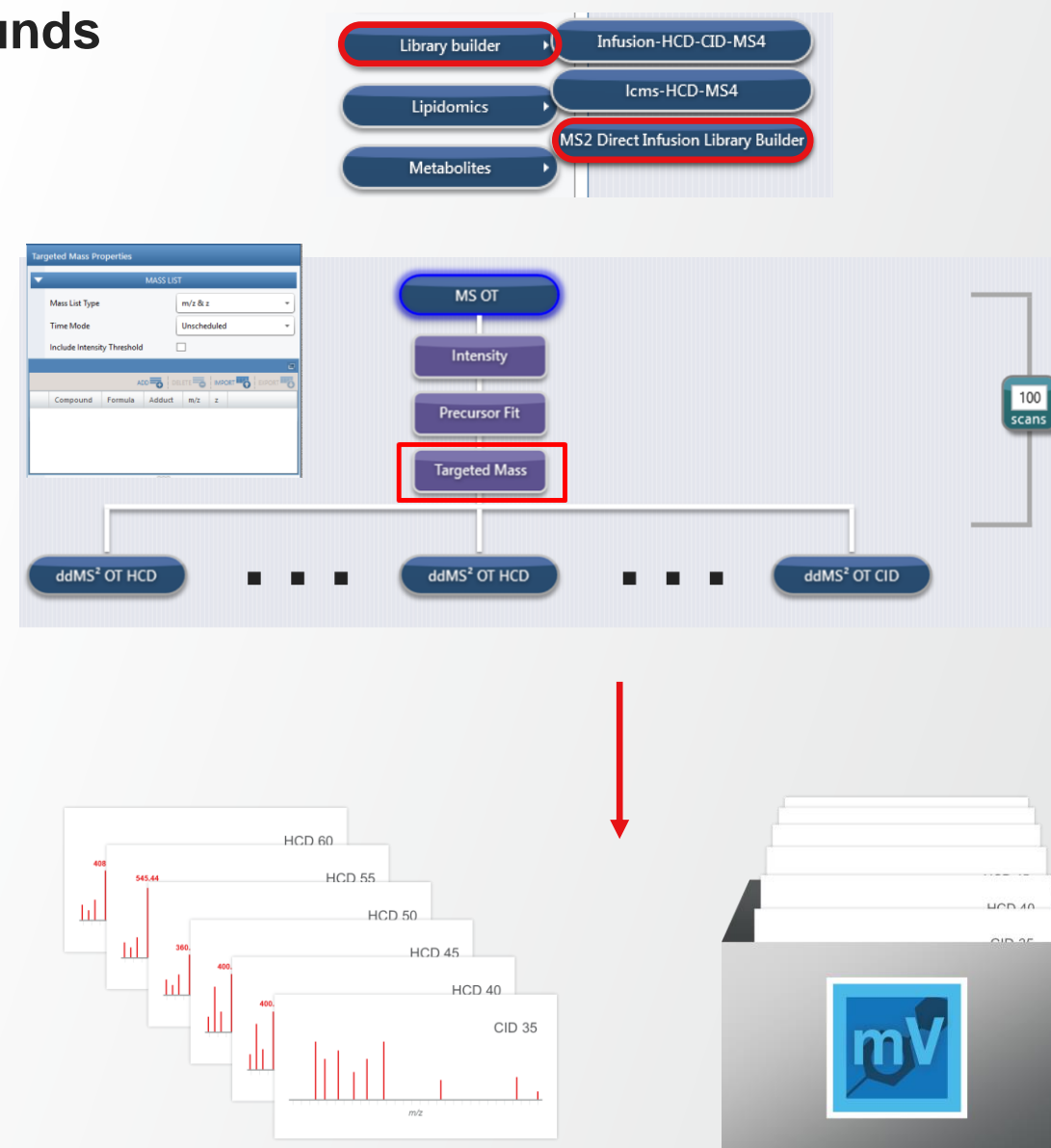

Real-Time Library Search – Based Acquisition Method

Application: MET-IQ - Intelligent mass spectrometry for small molecules

- Identification and characterization of unknown compounds, chemically similar to known compounds of interest
- Metabolomics applications, identification of various environmental contaminants, unknown extractables and leachables as well as emerging clinical toxins

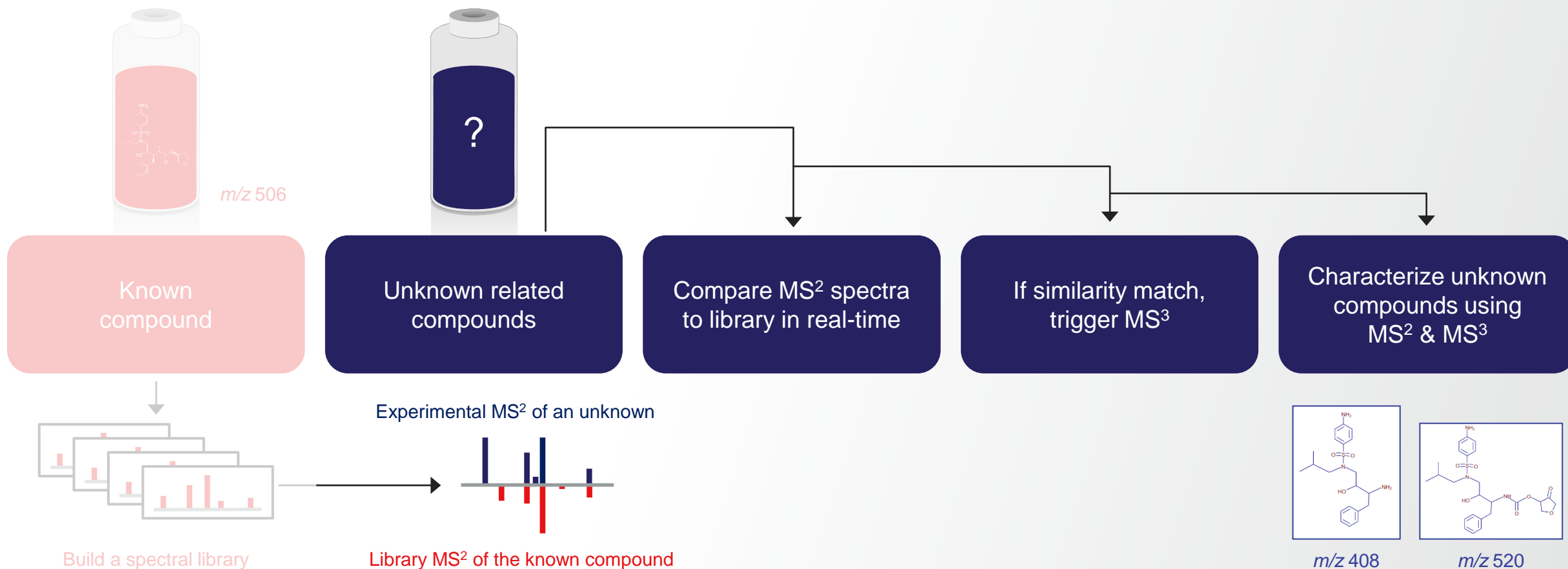

Real-Time Library Search – Based Acquisition Method

Application: MET-IQ - Intelligent mass spectrometry for small molecules

- Build a new method from the preset Met-IQ method template to interrogate the samples of unknown related compounds (transformational/metabolized products)
- During LC-MS/MS analyses of the samples
 - 1 MS2 profiling of the samples containing unknown related compounds is performed
 - 2 MS2 spectra are compared to spectral library in real-time (using broad precursor ion m/z search tolerance)
 - 3 MS3 are triggered only on compounds for which spectra are similar to the spectra of the compound of interest, prioritizing the selection of ions with high m/z (more informative)

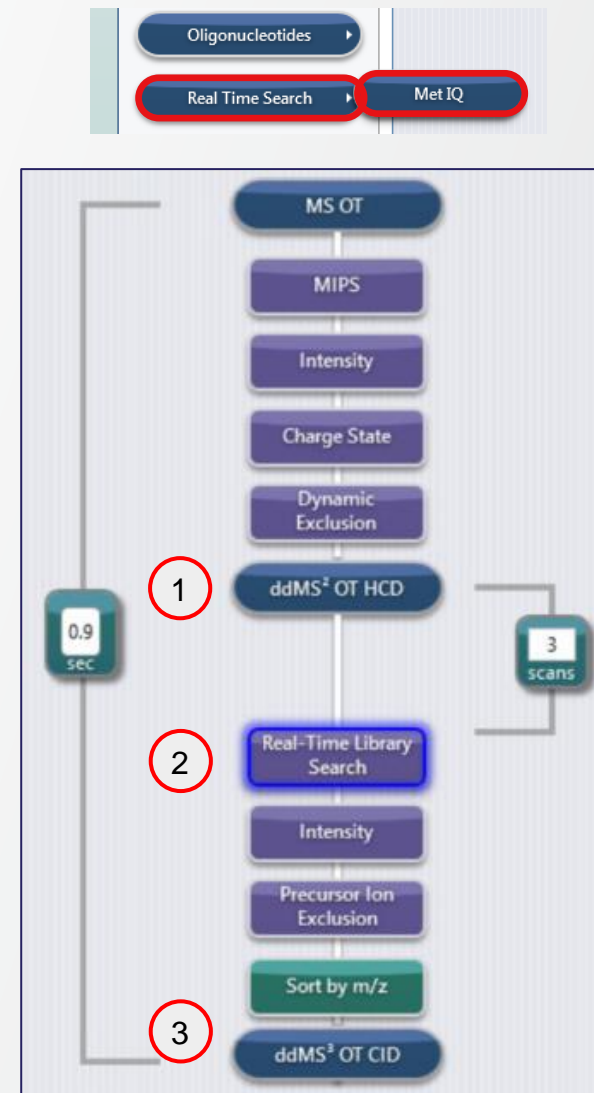

Real-Time Library Search – Based Acquisition Method

Application: MET-IQ - Intelligent mass spectrometry for small molecules

- During LC-MS/MS analyses of the samples
 - 1 MS2 profiling of the samples containing unknown related compounds is performed
 - 2 MS2 spectra are compared to spectral library in real-time (using broad precursor ion m/z search tolerance)
 - 3 MS3 are triggered only on compounds for which spectra are similar to the spectra of the compound of interest, prioritizing the selection of ions with high m/z (more informative)
- Post-acquisition data processing
 - 4
- Using Mass Frontier and Compound Discoverer
- Enabling further annotation of MS2 and MS3 spectra generated by MET-IQ
- Allowing the identification of unknown related compounds (transformational/metabolized products)

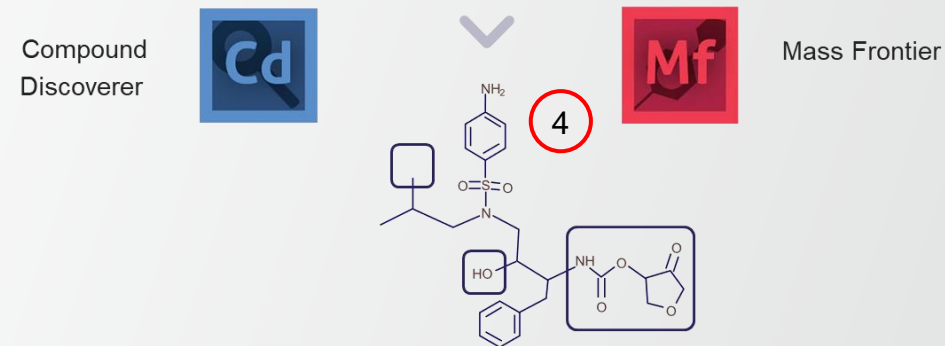
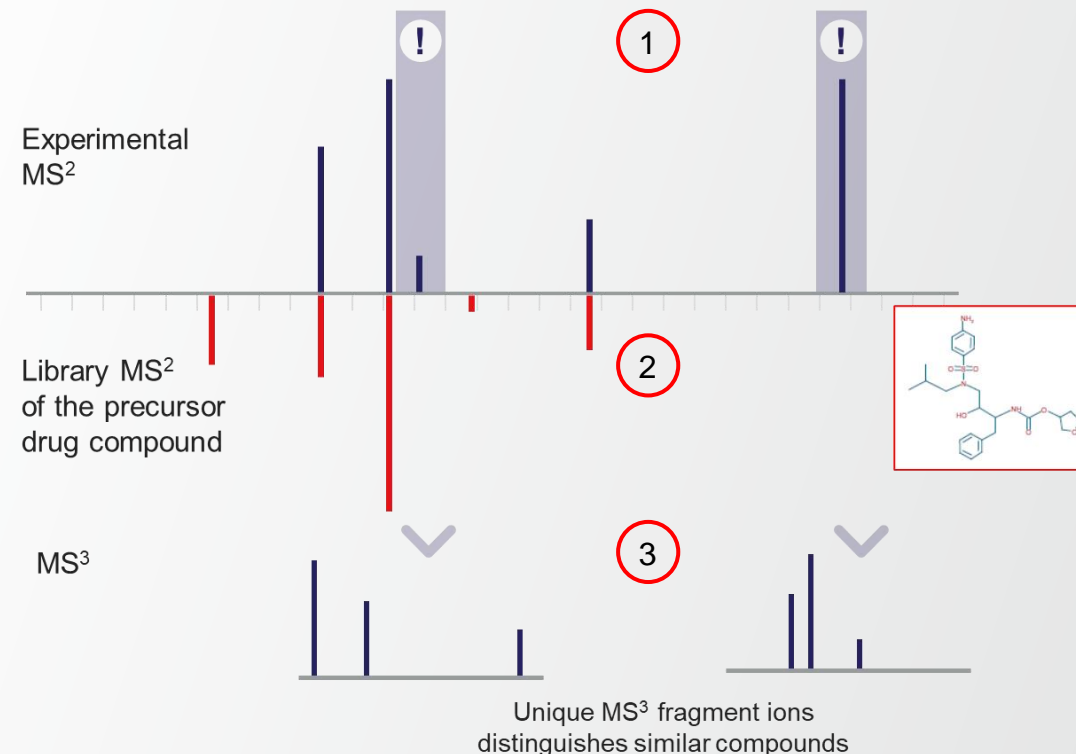

Real-Time Library Search – Based Acquisition Method

Application: Advanced elucidation of chemical structures

- No further acquisition for unambiguous & confident id. of the cmpds (high cosine / confidence / confidence delta)
- Optimization of CE if match appears under-fragmented (high cosine / low confidence)
- MS3 acquisition on high m/z fragments for compounds with ambiguous scores

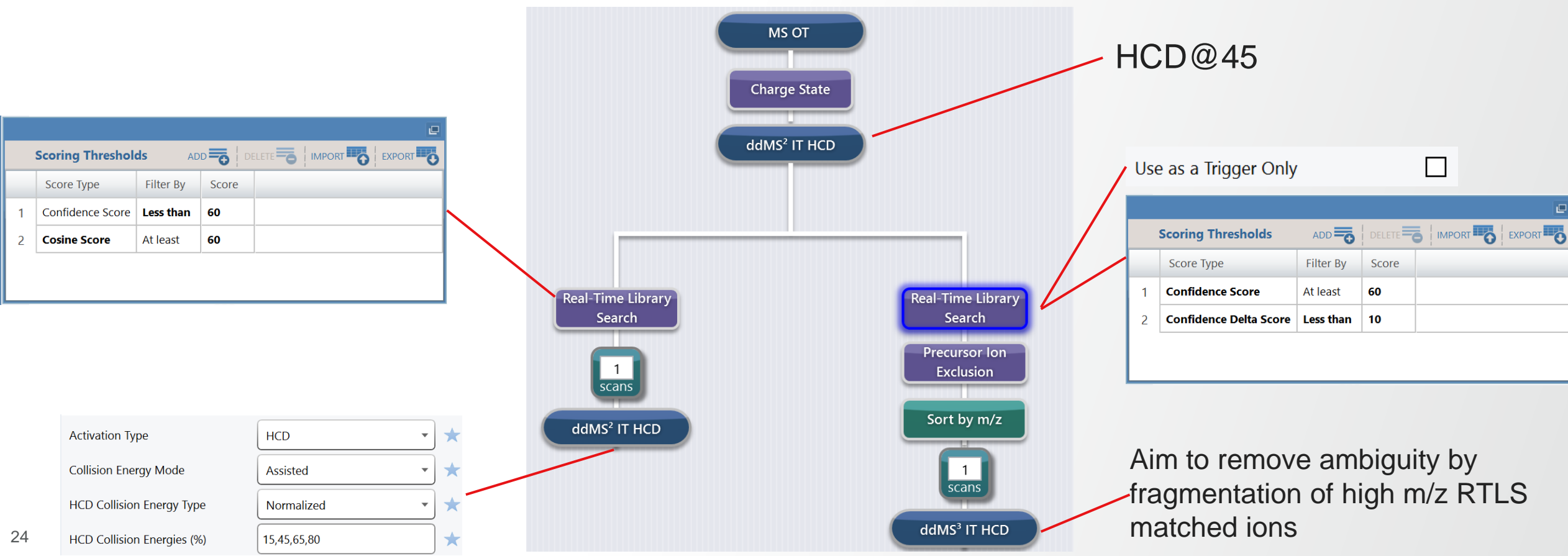

AcquireX Data Acquisition Workflow Enhancements



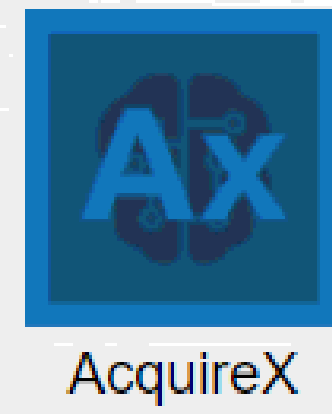

New Features

- Challenge
 - Higher coverage and throughput is required to expedite studies including 100s of samples
 - The ability to control multiple different matrix backgrounds is necessary in large scale studies
- Solution
 - New « Advanced Deep Scan » workflow to provide more flexibility in studies execution
 - New functionalities to improve user experience
- Availability
 - Xcalibur 4.5
 - All Tribrid models (small molecule application)



AcquireX Data Acquisition Workflow Enhancements

New « Advanced Deep Scan » Workflow to Provide More Flexibility in Studies Execution

 <p>BACKGROUND EXCLUSION</p> <p>Create and use an exclusion list of constant background ions and peaks to reduce background fragmentation in your ID runs</p> <p>What Xcalibur Does:</p> <ul style="list-style-type: none"> Generates up to 1 exclusion list per sequence Updates the ddMSn method with the exclusion list Automatically inject ID samples with updated ddMSn method <p>SELECT</p>	 <p>BACKGROUND EXCLUSION & COMPONENT INCLUSION</p> <p>Combines exclusion and inclusion lists to automatically and reliably acquire more relevant MSn data in a single injection</p> <p>What Xcalibur Does:</p> <ul style="list-style-type: none"> Generates up to 1 exclusion list per sequence Generates 1 inclusion list per ID injection block Injects user-defined number of ID injection blocks <p>SELECT</p>	 <p>ITERATIVE PRECURSOR EXCLUSION</p> <p>Creates and updates an exclusion list of the fragmented precursor ions over multiple ID injections to comprehensively enhance the fragmentation of non-redundant precursor ions</p> <p>What Xcalibur Does:</p> <ul style="list-style-type: none"> Generates one exclusion list per sequence Updates the exclusion list after every injection Injects ID samples until all the ions in the sample are fragmented or user-defined number of ID samples are reached <p>SELECT</p>	 <p>DEEP SCAN</p> <p>Combines a single exclusion and inclusion list with multiple ID injections to comprehensively fragment relevant precursor ions</p> <p>What Xcalibur Does:</p> <ul style="list-style-type: none"> Generates up to 1 exclusion list per sequence Generates up to 1 inclusion list per sequence Injects ID samples until all inclusion list ions are fragmented or user-defined number of ID samples are reached <p>SELECT</p>
 <p>ADVANCED DEEP SCAN</p> <p>Combines up to 5 exclusion and inclusion lists with multiple ID injections to comprehensively fragment relevant precursor ions and submits multiple samples.</p> <p>What Xcalibur Does:</p> <ul style="list-style-type: none"> Combines up to 5 exclusion references into 1 exclusion list per group. Combines up to 5 inclusion references into 1 inclusion list per group. Injects ID samples until all inclusion list ions are fragmented or user-defined number of ID samples are reached 	<p>RECENT EXPERIMENTS</p> <p>There are no recent experiments. Browse to open an existing experiment.</p>		

AcquireX Data Acquisition Workflow Enhancements

New « Advanced Deep Scan » Workflow to Provide More Flexibility in Studies Execution

- Submit several samples defined by groups with different instrument methods in the same experiment
- Combine up to 5 inclusion or exclusion lists that are applied to the subsequent id injections
- Add wash/blank samples anywhere in the sequence
- Group overview facilitated in Read-only table

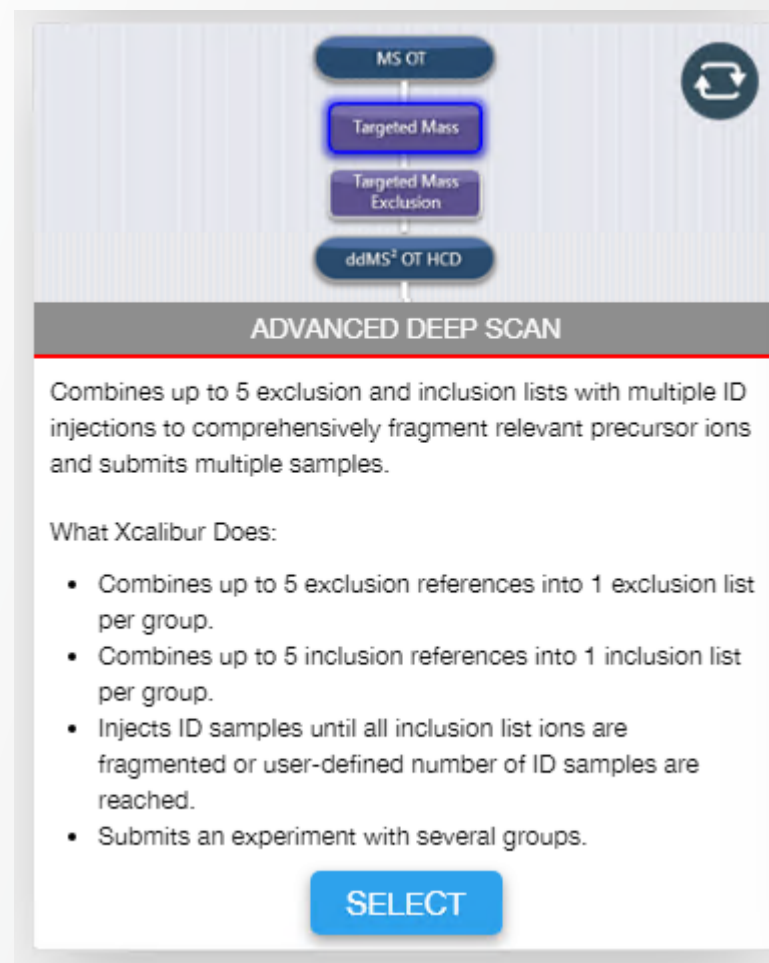

AcquireX Data Acquisition Workflow Enhancements

Advanced Deep Scan – Sequence Design



ADVANCED DEEP SCAN

Combines up to 5 exclusion and inclusion lists with multiple ID injections to comprehensively fragment relevant precursor ions and submits multiple samples.

What Xcalibur Does:

- Combines up to 5 exclusion references into 1 exclusion list per group.
- Combines up to 5 inclusion references into 1 inclusion list per group.
- Injects ID samples until all inclusion list ions are fragmented or user-defined number of ID samples are reached.
- Submits an experiment with several groups.

SELECT

Sequence Design Max value: 10 5 5 30 25

AcquireX Template Injections [dropdown] [edit] [trash] Blanks 1 Excl. Ref 1 Incl. Ref 2 Deep Scan Inj. 4 # Groups to Add 1 **Add**

#	Name	Type	Group	Instrument Method	Vial	Inj Vol (µl)	
---	------	------	-------	-------------------	------	--------------	--

Edit a specific group

Delete a specific group

Sequence Design

AcquireX Template Injections [dropdown] [edit] [trash] Blanks 1 Excl. Ref 1 Incl. Ref 2 Deep Scan Inj. 4 # Groups to Add 1 **Add**

#	Name	Type	Group	Instrument Method	Vial	Inj Vol (µl)	
---	------	------	-------	-------------------	------	--------------	--

AcquireX Data Acquisition Workflow Enhancements

Advanced Deep Scan – Adding a Group in the Sequence

Sequence Design

AcquireX Template Injections | ▼ | | Blanks 1 Excl. Ref 1 Incl. Ref 2 Deep Scan Inj. 4 # Groups to Add 1 Add

#	Name	Type	Group	Instrument Method	Vial	Inj Vol (μl)	

To add one or several groups

Sequence Design

AcquireX Template Injections | **Group 1** | | Blanks 1 Excl. Ref 1 Incl. Ref 2 Deep Scan Inj. 4 # Groups to Add 1 Add

#	Name	Type	Group	Instrument Method	Vial	Inj Vol (μl)	
1	Blank_01	Blank	1	Instrument Method	1	10.00 μl	
2	ExclusionRef_01	Exclusion	1	Instrument Method	1	10.00 μl	...
3	Sample_01	Inclusion	1	Instrument Method	1	10.00 μl	...
4	Sample_02	Inclusion	1	Instrument Method	1	10.00 μl	...
5	ID_01	Id	1	Instrument Method	1	10.00 μl	...
6	ID_02	Id	1	Instrument Method	1	10.00 μl	...
7	ID_03	Id	1	Instrument Method	1	10.00 μl	...
8	ID_04	Id	1	Instrument Method	1	10.00 μl	...

AcquireX Data Acquisition Workflow Enhancements

Advanced Deep Scan – Inserting a wash/blank sample in the Sequence

The screenshot displays the 'Sequence Design' window in AcquireX. The top toolbar includes fields for 'Blanks' (1), 'Excl. Ref' (1), 'Incl. Ref' (2), 'Deep Scan Inj.' (4), and '# Groups to Add' (1), along with an 'Add' button. The main table lists the sequence steps:

#	Name	Type	Group	Instrument Method	Vial	Inj Vol (µl)
1	Blank_01	Blank				
2	ExclusionRef_01	Exclusion				
3	Sample_01	Inclusion				
4	Sample_02	Inclusion				
5	ID_01	Id				
6	Unknown_01	Unknown	1	Instrument Method	1	10.00 µl
7	ID_02	Id	1	Instrument Method	1	10.00 µl
8	ID_03	Id	1	Instrument Method	1	10.00 µl
9	ID_04	Id	1	Instrument Method	1	10.00 µl

A context menu is open over the 'ID_01' row, with the 'Insert Inj Above' option selected. A tooltip 'Insertion above ID 01' is visible over the 'Unknown_01' row in the main table.

Right click on a row to add wash/blank samples

AcquireX Data Acquisition Workflow Enhancements

Advanced Deep Scan – Group Overview

Editable table

Sequence Design

AcquireX Template Injections | Group 4 | Blanks 1 | Excl. Ref 1 | Incl. Ref 2 | Deep Scan Inj. 3 | # Groups to Add 1 | Add

#	Name	Type	Group	Instrument Method	Vial	Inj Vol (µl)	Comment
1	Blank_01	Blank	1	MS1	1	10.00 µl	group 1
2	ExclusionRef_01	Exclusion	1	MS1	2	10.00 µl	
3	Sample_01	Inclusion	1	MS1	3	10.00 µl	
4	Sample_02	Inclusion	1	MS1	4	10.00 µl	
5	ID_01	Id	1	MSn incl_excl	5	10.00 µl	
6	ID_02	Id	1	MSn incl_excl	5	10.00 µl	
7	ID_03	Id	1	MSn incl_excl	5	10.00 µl	
8	Wash	Unknown	1	MS1	20	10.00 µl	
9	ExclusionRef_01	Exclusion	2	MS1	5	10.00 µl	group 2
10	ExclusionRef_02	Exclusion	2	MS1	6	10.00 µl	
11	Sample_01	Inclusion	2	MS1	7	10.00 µl	
12	Sample_02	Inclusion	2	MS1	8	10.00 µl	
13	Sample_03	Inclusion	2	MS1	9	10.00 µl	
14	ID_01	Id	2	MSn incl_excl	10	10.00 µl	
15	ID_02	Id	2	MSn incl_excl	10	10.00 µl	
16	ID_03	Id	2	MSn incl_excl	10	10.00 µl	
17	Unknown_01	Unknown	3	Wash	20	10.00 µl	group 3
18	Unknown_02	Unknown	3	Wash	20	10.00 µl	
19	Blank_01	Blank	4	MS1	11	10.00 µl	group 4
20	ExclusionRef_01	Exclusion	4	MS1	12	10.00 µl	
21	Sample_01	Inclusion	4	MS1	13	10.00 µl	
22	Sample_02	Inclusion	4	MS1	14	10.00 µl	
23	ID_01	Id	4	MSn incl_excl	15	10.00 µl	
24	ID_02	Id	4	MSn incl_excl	15	10.00 µl	
25	ID_03	Id	4	MSn incl_excl	15	10.00 µl	
26	Unknown_01	Unknown	4	MS1	20	10.00 µl	

Back Cancel Export Import Save Save As Submit

Icons to toggle between the view

Read-only table

Sequence Design

AcquireX Template Injections | Total Injection: 26

#	Group	Type	Injection	Instrument Method	Vial
1	1	Blank	1	MS1	1
2	1	Exclusion	1	MS1	2
3	1	Inclusion	2	MS1	3,4
4	1	Id	3	MSn incl_excl	5
5	1	Unknown	1	MS1	20
6	2	Exclusion	2	MS1	5,6
7	2	Inclusion	3	MS1	7,8,9
8	2	Id	3	MSn incl_excl	10
9	3	Unknown	2	MS1	20
10	4	Blank	1	MS1	11
11	4	Exclusion	1	MS1	12
12	4	Inclusion	2	MS1	13,14
13	4	Id	3	MSn incl_excl	15
14	4	Unknown	1	MS1	20



AcquireX Data Acquisition Workflow Enhancements

Advanced Deep Scan – User-Defined Parameters

ADVANCED DEEP SCAN

Combines up to 5 exclusion and inclusion lists with multiple ID injections to comprehensively fragment relevant precursor ions and submits multiple samples.

What Xcalibur Does:

- Combines up to 5 exclusion references into 1 exclusion list per group.
- Combines up to 5 inclusion references into 1 inclusion list per group.
- Injects ID samples until all inclusion list ions are fragmented or user-defined number of ID samples are reached.
- Submits an experiment with several groups.

SELECT

Experiment Details

Experiment Folder **Browse**

Experiment Name

Apply Name Extension

Display Comment Column

Apply To All Groups ⓘ Group # **1** ▼

Group Parameters

Instrument Methods

Full Scan Method ⓘ **Browse** **New**

MSn Template Method ⓘ **Browse** **New**

Experiment Parameters

Exclusion Override Factor (default = 3)
3 ⓘ

Exclusion List Peak Window Extension (s) (default = 0 s)
0 ⓘ

Inclusion List Peak Window Extension (s) (default = 0 s)
0 ⓘ

Inclusion List Peak Fragmentation Threshold (%) (default = 50%)
50 ⓘ

Preferred Ions
[M+H]⁺+1; [M-H]⁻-1 ▼

Exclusion Duration (seconds)
10 ⓘ

Enable automatic adding of Isotopes ⓘ

Each group can have different experiment parameters

Same as Xcalibur 4.4

AcquireX Data Acquisition Workflow Enhancements

Advanced Deep Scan to Submit several “Iterative Precursor Exclusion” samples

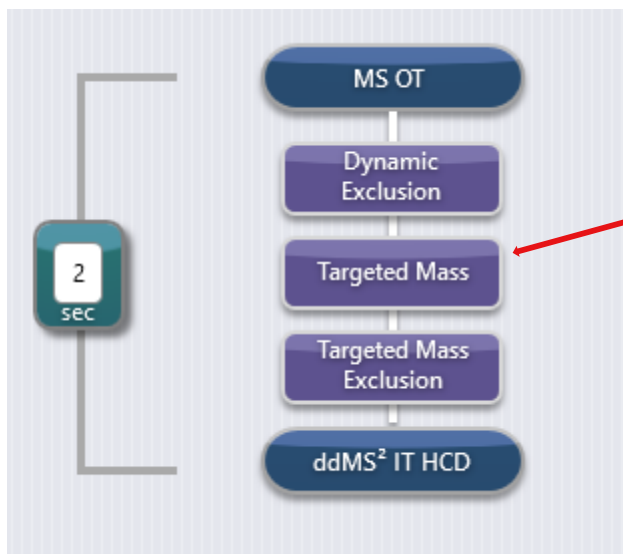

For a deep scan experiment an inclusion list is required in the method.

Targeted Mass Properties

MASS LIST

Mass List Type: m/z

Time Mode: Start/End Time

Include Intensity Threshold:

Compound	m/z	t start (m)	t stop (min)	Intensity Threshold
1 Cannot be deleted	100	0	17	1.0e20

The intensity that this target m/z must meet or exceed to be included
Range: 0-1E+20

Mass Tolerance: ppm

Low: 10

High: 10

Perform dependent scan on most intense ion if no targets are found:

Sequence Design

AcquireX Template Injections | Group 2 | Blanks 0 | Excl. Ref 1 | Incl. Ref 0 | Deep Scan Inj. 4 | # Groups to Add 1 | Add

#	Name	Type	Group	Instrument Method	Vial	Inj Vol (µl)	Comment
1	ID_01	Id	1	MSn inclexcl	1	10.00 µl	group 1
2	ID_02	Id	1	MSn inclexcl	1	10.00 µl	
3	ID_03	Id	1	MSn inclexcl	1	10.00 µl	
4	ExclusionRef_01	Exclusion	2	MS1	1	10.00 µl	group 2
5	ID_01	Id	2	MSn inclexcl	1	10.00 µl	
6	ID_02	Id	2	MSn inclexcl	1	10.00 µl	
7	ID_03	Id	2	MSn inclexcl	1	10.00 µl	
8	ID_04	Id	2	MSn inclexcl	1	10.00 µl	

- After ID1, all of the targeted ions will be added to the exclusion list.
- If the inclusion list is not empty, the next ID run will start
- After the number of ID runs are acquired, the next group will be submitted.

AcquireX Data Acquisition Workflow Enhancements

New Functionalities to Improve User Experience

- User-defined minimum intensity for inclusion and exclusion lists for all existing and new AcquireX experiments
- Import/Export Acquirex Experiment from the Advanced Deep Scan, Deep Scan, and Iterative Precursors Exclusion workflows as a .csv file
- New column available to add comments
- Copy/fill down for sample name, vial position and injection volume
- Option to skip to the next queued sequence automatically if a processing error occurs
- Parallel acquisition and processing to save time and reduce solvent consumption

New parameters in Xcalibur 4.5

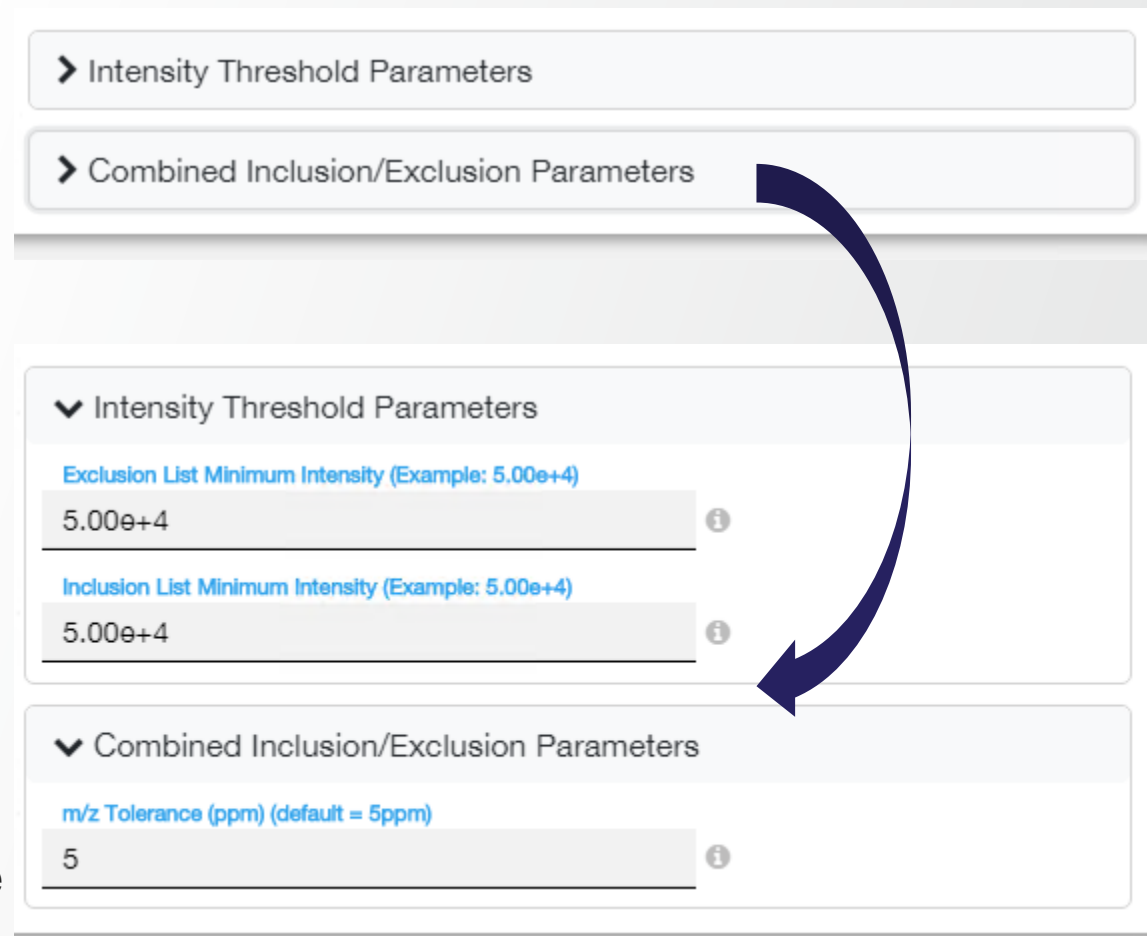

The screenshot displays the Xcalibur 4.5 software interface. At the top, there are two menu items: 'Intensity Threshold Parameters' and 'Combined Inclusion/Exclusion Parameters'. Below these, the 'Intensity Threshold Parameters' section is expanded, showing two input fields: 'Exclusion List Minimum Intensity (Example: 5.00e+4)' and 'Inclusion List Minimum Intensity (Example: 5.00e+4)', both with a value of 5.00e+4. The 'Combined Inclusion/Exclusion Parameters' section is also expanded, showing an input field for 'm/z Tolerance (ppm) (default = 5ppm)' with a value of 5. A large blue curved arrow points from the 'Combined Inclusion/Exclusion Parameters' menu item to the expanded settings panel.

Auto-Ready Ion Source

New Features

- Challenge
 - Time dedicated to instrument setup must be minimized
 - Instrument must remain well calibrated over time
- Solution
 - Built-in Auto-Ready Ion Source simplifies maintenance with weekly pre-scheduled, remote, and one-click calibration
- Availability
 - Orbitrap IQ-X

New Auto-Ready Calibration Source

Its own ion transfer tube

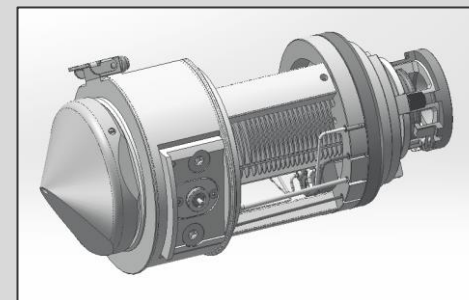

Robust delivery system



Dedicated emitter

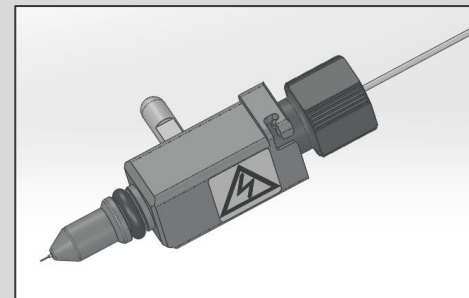

Auto-Ready Ion Source

Setting up Auto-Calibration

Under Tune Preferences



Tune Preferences

Report Options

Calibration Reports

Automatically generate reports
Path: C:\Thermo\Instruments\Reports\

Show Report Generation Options dialog box
 Do not generate reports

Other Reports

Automatically generate reports
Path: C:\Thermo\Instruments\Reports\

Show Report Generation Options dialog box
 Do not generate reports

Report Content Options

Show Console
 Show graph
 Show spectrum
 Show system configuration
 Show embedded system configuration

Current Calibration Options

Set System to Standby on Completion

Calibration Source

Auto-Ready
 Other

Calibration Mix

Traditional
 FlexMix

System Self-Check Options

Run system self-check in 'Check' mode
 Run system self-check in 'Check, Calibrate if required' mode
(please press F1 to view the help on what will be run for self-check)

Schedule Self-Check

Day: Wednesdays Time: 12 AM

Settings

Polarity: Positive

UVPD
 Easy-IC

Current Calibration Options

Set System to Standby on Completion

Calibration Source

Auto-Ready
 Other

System Self-Check Options

Run system self-check in 'Check' mode
 Run system self-check in 'Check, Calibrate if required' mode
(please press F1 to view the help on what will be run for self-check)

Schedule Self-Check

Day: Wednesdays Time: 12 AM

Settings

Polarity: Positive

UVPD
 Easy-IC

- Current Calibration Options
 - “Auto-Ready” is set as Calibration Source by default (auto and manual modes)
 - Select “Other” to calibrate with syringe pump (manual mode only)
 - Auto-Ready Ion Source only uses pre-filled FlexMix vials
- System Self –Check Options
 - Self-Check can be set to « Check » or « Check, Calibrate if required » (and systematically set to « Orbitrap Mass & System » calibration type)
 - Day and time for Self-Check is defined
 - The polarity (« Positive » or « Positive & Negative ») and optional calibrations used for Self-Check are defined in Settings section

Auto-Ready Ion Source

Self-Check Pre-Conditions

- Self-Check settings
 - They are indicated in status pane of calibration tab
- Self-Check (Auto-Calibration) procedure is pursued only if
 - The instrument is in standby or scanning (“On”)
 - Auto-Ready is current Calibration Source in Tune Preferences
 - Self-Check is enabled in diagnostics (notification in Tune Preferences Self-Check is disabled)
- Self-Check procedure is deferred and subsequently run if
 - There is an acquisition in progress (acquisition sequence or tune recording) at the time of scheduled Self-Check
 - Acquisition queue gets empty within the 24 hours of scheduled Self-Check (check every 5 min)

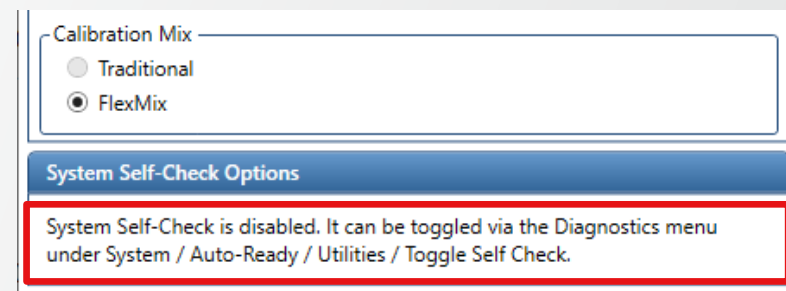
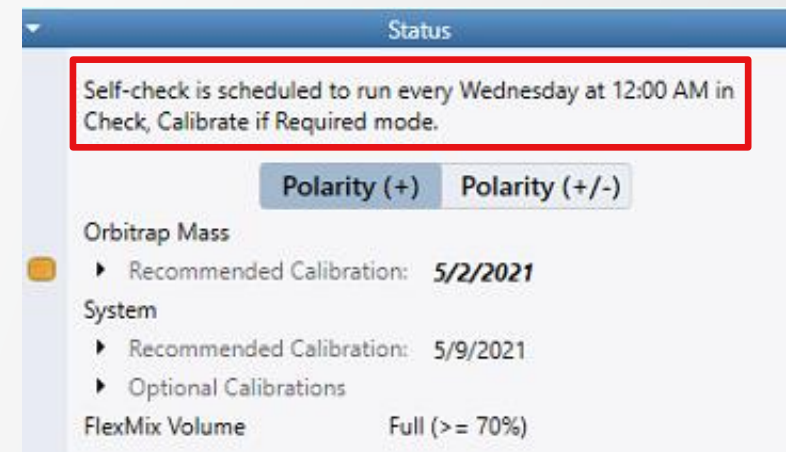

Auto-Ready Ion Source

Self-Check Procedure

- 5-min delay Self-Check preparation
 - Notification displayed in Tune bottom panel that Self-Check is about to start; text updated every minute



- Same information displayed in notification area of calibration panel
- Show « Initiate Self-Check » / « Abort Self-Check » buttons and disable « Start » button in calibration panel



- Self-Check execution
 - Start after 5-min preparation has elapsed
 - Instrument is switched to « On » if currently in standby
 - Calibration UI selection updated to match Self-Check settings (mode, polarity, and optional calibrations)
 - During Self-Check execution
 - Tune operations are disabled, procedure can be aborted by pressing relevant button (aborted Self-Check not run until next scheduled check)
 - Self-Check running status is displayed (progress bar, notification panel)

Auto-Ready Ion Source

Calibration Tab

- « Manual » conventional one-click calibration
 - Can be performed at any time by pressing « Start » in Calibration tab
 - All conventional calibration modes and types are available
- Auto-Ready Ion Source is used for « Manual » one-click calibration as long as it is defined as the Calibration Source in Tune Preferences
- Status pane displays calibration sets with recommended re-calibration dates
 - Dates become bolded/italicised when due date = today or day in past
- Caret opens to display last calibration dates
- Under System, last calibration dates can be displayed for optional calibrations

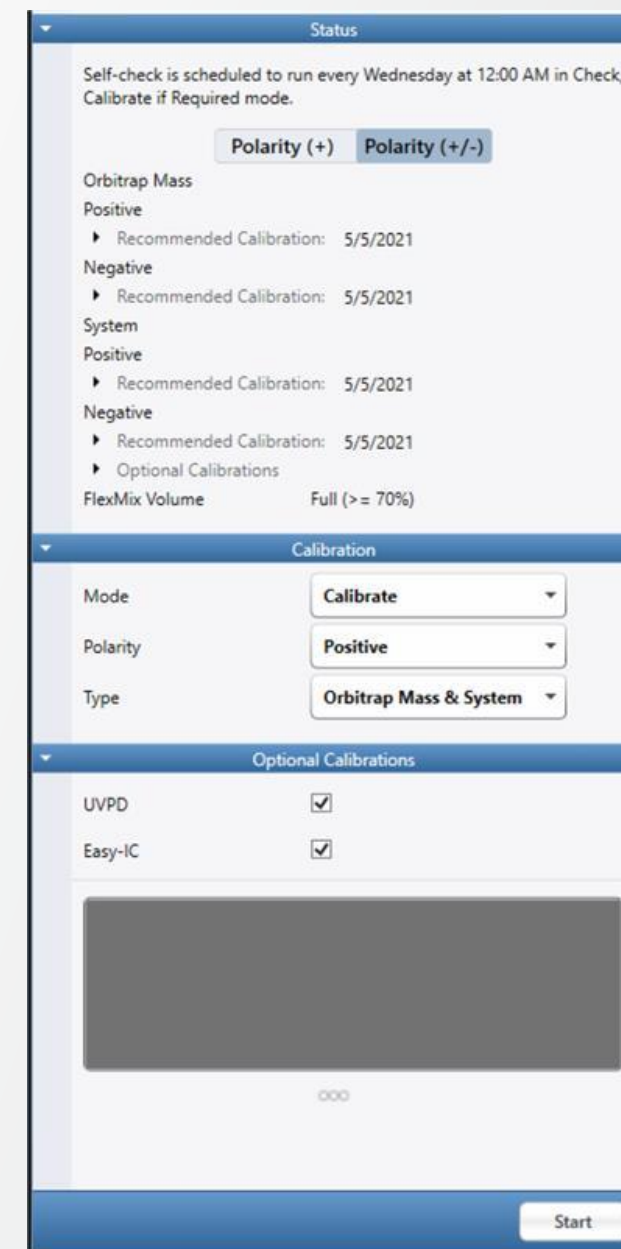

Same as with Conventional source

Auto-Ready Ion Source

Calibration Tab - Calibration Types

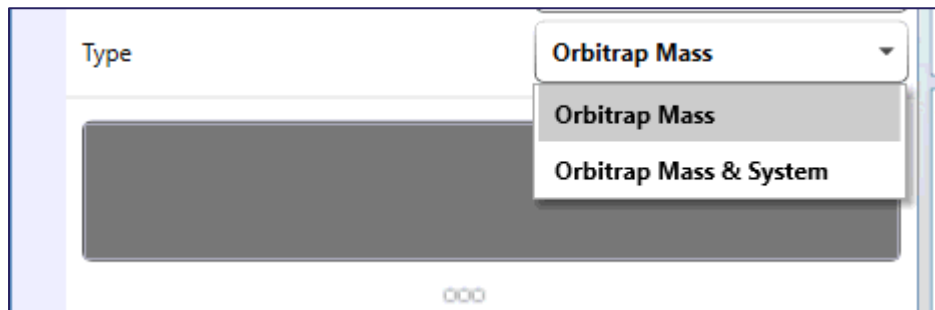

- Types: **Orbitrap Mass** or **Orbitrap Mass & System**
- Selecting Orbitrap Mass triggers the following calibrations:
 - multiplier
 - Orbitrap mass
- Selecting Orbitrap Mass & System triggers the following calibration set, in order:
 - Ion Optics
 - Ion Trap
 - Quadrupole
 - pAGC
 - Orbitrap mass
- If Orbitrap Mass & System selected, “Optional Calibrations” are exposed (based on configuration & polarity* selected)

Same as with Conventional source

Auto-Ready Ion Source

Calibration Tab - Calibration Modes

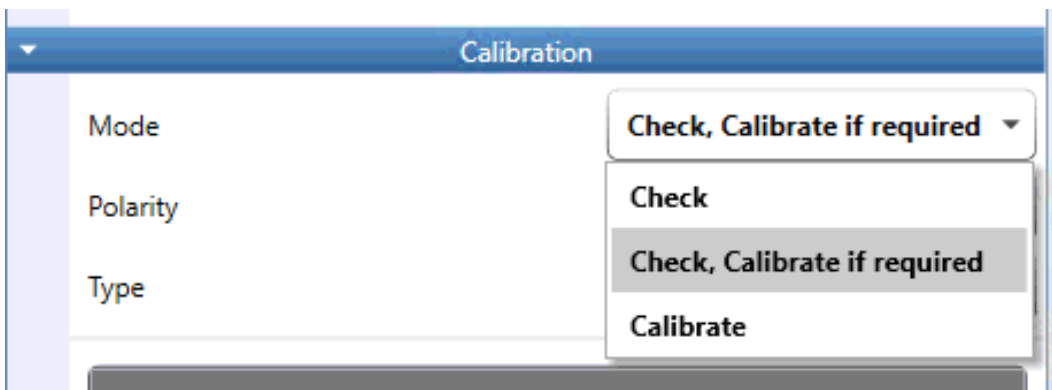

- Modes: “Check”, “Check, calibrate if required”, or “Calibrate”
 - A spray check and calibrant purity evaluation are automatically run prior to any calibration set
- “Check, calibrate if required” operates as follows:
 - Any failed checks are automatically calibrated (as well as dependent calibrations)
 - The system automatically runs calibrations that have expired (bypass check), i.e., *Multiplier gain* after 7 days and all remaining calibrations after 28 days
 - The system automatically runs Orbitrap mass calibration

Same as with Conventional source

Auto-Ready Ion Source

Calibration Tab

- Calibration status are displayed for polarity (+) or (+/-)
- FlexMix level is indicated in status panel
 - “Full” when $\geq 3.75\text{ml}$ ($\geq 75\%$)
 - 0% when $\leq 125\mu\text{l}$
 - 70% when $\geq 3.50\text{ml}$
 - 5% decrement starting at 70%
 - “Replace Vial” when 0%
- Red indicator is displayed when 0% - start button is disabled, hover text indicates ‘Replace Vial’
- Orange indicator is displayed when 10% - 1%
- No color indicator when above 10%

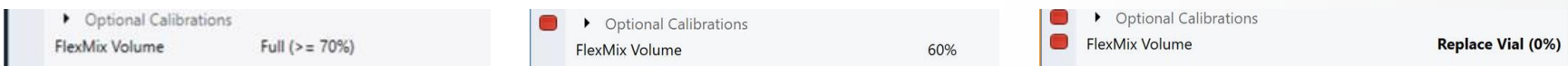
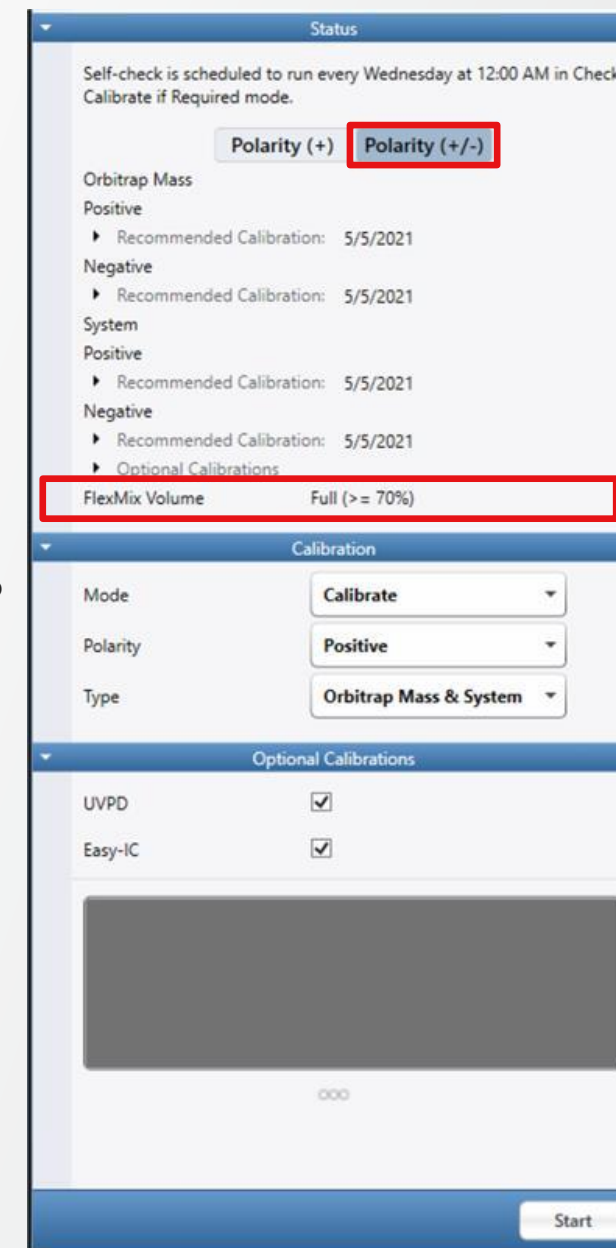

- Calibration Polarity:
 - Positive
 - Positive and Negative

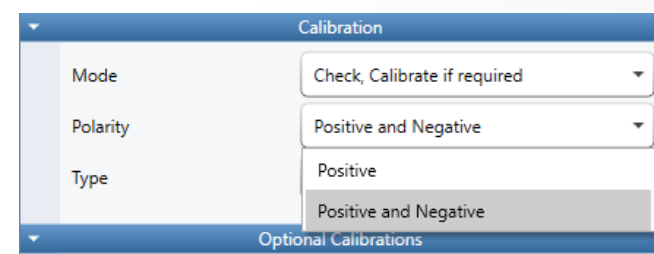

Auto-Ready Ion Source

Calibration Results – Self-Correction And Recommendations

- Upon any calibration failure, two procedure checks are run before the result is reported:
 1. Spray stability check
 - If spray check fails, system will attempt to self-correct spray issue for 5 min. Once stable spray is re-established, the sequence will resume starting from the procedure that originally failed
 - If spray cannot be recovered, the check is aborted and the following notifications appears: “A <procedure> failed due to spray instability. Please see below for recovery recommendations.”
 - “A <procedure> failed due to spray instability. Please perform following tasks and retry:
 - -- Run the 'Flush Calibration Source Lines' diagnostic in attempt to clear any residual air bubbles from the lines
 - -- Re-seat the fittings between the calibrant pump and the sprayer
 - -- Run the 'Calibration Source HV Calibration' diagnostic to ensure the spray voltage is set properly
 - If spray check passes, the second procedure check is run.
 2. Calibrant purity evaluation
 - If cal mix evaluation fails, system will attempt to recover acceptable calibrant purity by running one flush cycle of calibration source lines
 - If acceptable cal mix purity cannot be recovered, the procedure is aborted and the following notifications appears: “A <procedure> failed due to calibrant contamination or degradation. Please see below for recovery recommendations.”
 - “A <procedure> failed due to calibrant contamination or degradation. Please perform following tasks and retry:
 - -- Run the 'Flush Calibration Source Lines' diagnostic in attempt to clear any contamination buildup from the lines
 - -- Change the calibrant bottle to a fresh one

Auto-Ready Ion Source

Calibration Results – Procedure vs Calibration Failure

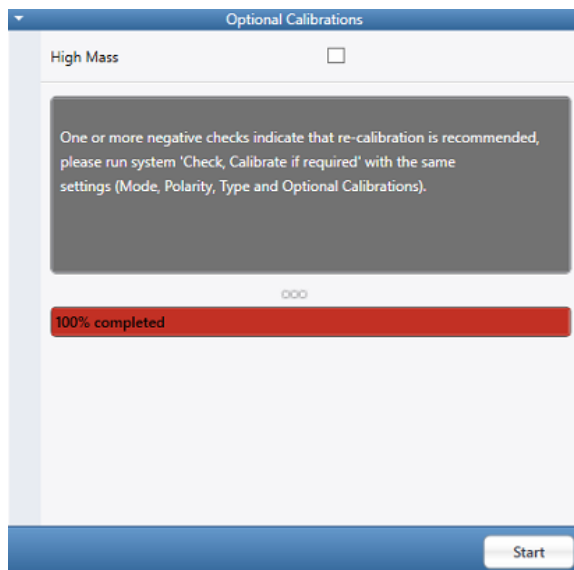

- If the 'Check-only' routine is failed, but procedure checks pass, the system will recommend the user run in "Check, Calibrate if required" mode.

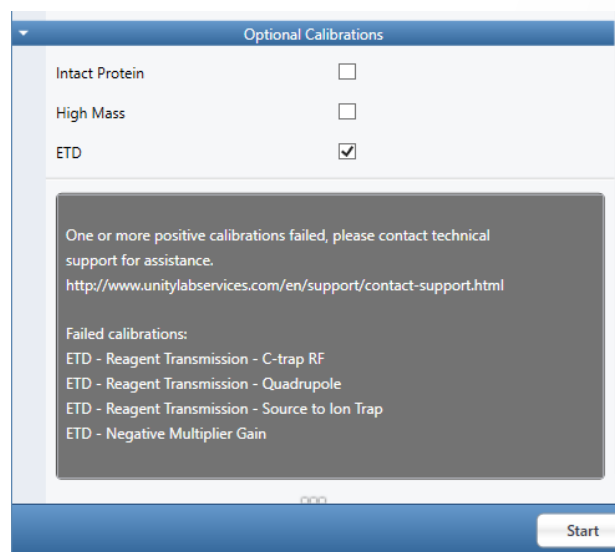

- If the calibration is run in 'Check, Calibrate if required" or "Calibrate" mode and fails, but both procedure checks pass, a true calibration failure is recorded.

Same as with Conventional source

Auto-Ready Ion Source

Calibration Results – ‘Orange’ vs ‘Red’ Status

The screenshot shows the 'Status' page of the instrument. At the top, it says 'Self-check is scheduled to run every Wednesday at 12:00 AM in Check, Calibrate if Required mode.' Below this, there are two buttons: 'Polarity (+)' and 'Polarity (+/-)'. Underneath, there are three sections: 'Orbitrap Mass' with a yellow indicator light and 'Recommended Calibration: 5/2/2021', 'System' with 'Recommended Calibration: 5/9/2021' and 'Optional Calibrations', and 'FlexMix Volume' with 'Full (>= 70%)'.

The screenshot shows the 'Status' page of the instrument. At the top, it says 'Self-check is scheduled to run every Wednesday at 12:00 AM in Check, Calibrate if Required mode.' Below this, there are two buttons: 'Polarity (+)' and 'Polarity (+/-)'. Underneath, there are three sections: 'Orbitrap Mass' with a red indicator light and 'Recommended Calibration: 5/2/2021', 'System' with 'Recommended Calibration: 5/9/2021' and 'Optional Calibrations', and 'FlexMix Volume' with 'Full (>= 70%)'.

- Status will show an orange indicator light when:
 - A procedure failure (spray stability or calibrant purity evaluation) is recorded during a calibration procedure
 - A single calibration is run from diagnostics
 - A single check is run from diagnostics and fails
 - A procedure is aborted
- Status will show a red indicator light when:
 - A true calibration failure is recorded (calibration fails and both procedure checks pass)
- Hovering over indicator light will provide explanation of state

A calibration or check procedure run from diagnostic has completed. Please run a System calibration from the Calibration Tab in "Check, calibrate if required" mode to recover and /or receive detailed recovery instructions.

Same as with Conventional source

Auto-Ready Ion Source

Calibration Procedures in Diagnostics

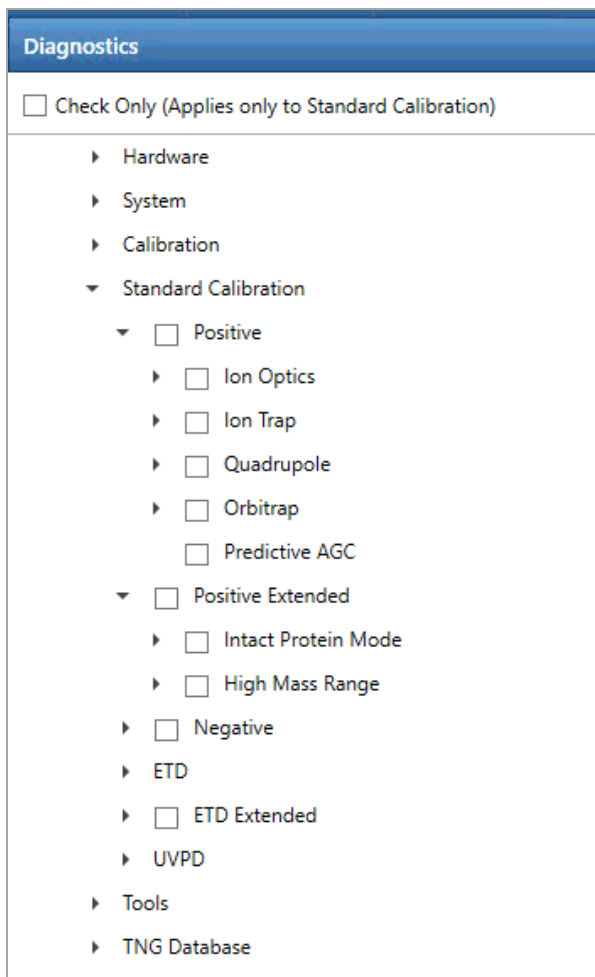

- Calibration tree can be found in the customer diagnostics pane under “Standard Calibration”
 - Individual calibrations may be checked or run
 - As the system requires calibrations to be run in the proper order as a set and some calibrations affect dependent calibrations, calibrating from the diagnostics pane will have the following affect on the status panel in the calibration pane:

Result in Diagnostics	Impact on Status Panel
Check passes	No impact
Check fails	Associated set ORANGE
Calibration passes	Associated set ORANGE
Calibration fails	Associated set ORANGE

Same as with Conventional source

Auto-Ready Ion Source

Diagnostics & Readbacks

- Auto Ready Ion Source Diagnostics
 - FlexMix infusion using Auto Ready Ion Source must be manually started to run a diagnostic that requires it **(A)**
 - Toggle available to enable / disable Self-Check **(B)**
- Auto Ready Ion Source Readbacks

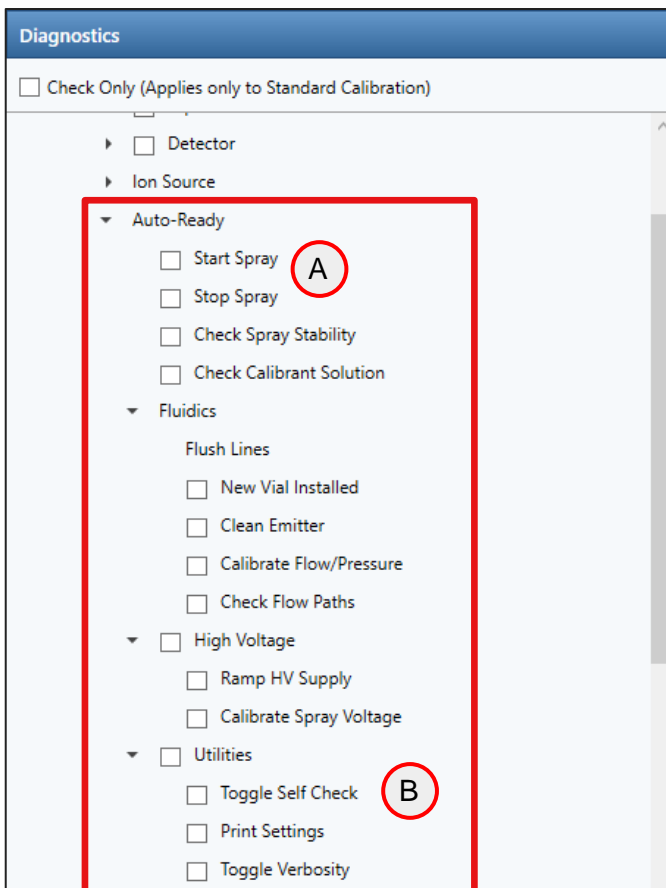

System Self-Check Options

System Self-Check is disabled. It can be toggled via the Diagnostics menu under System / Auto-Ready / Utilities / Toggle Self Check.

STATUS		By Function
▲	Ion Source	
	Spray Voltage	-8.2 V
	Spray Current	0.0 μA
	Vaporizer Temp	30.5 °C
	Sheath Gas	2.1 Arb (~0.44 L/Min)
	Aux Gas	2.1 Arb (~2.52 L/Min)
	Sweep Gas	2.0 Arb (~2.72 L/Min)
	Ion Transfer Tube Temp	275.0 °C
	S-lens DC	18.3 V
	Source Pressure	1.392 Torr
▲	Auto-Ready	
	Spray Voltage	0.2 V
	Spray Current	0.0 μA
	FlexMix Volume	50%
▶	Ion Guide 1	
▶	Quadrupole	

Improvements in FAIMS Support

New Features and Integration with Orbitrap Tribrid Series ICSW 3.5

- The new FAIMS Pro Duo Interface extends FAIMS application to a wide range of chromatographic flow rates
- Compensation Voltage (CV) switching time has been further optimized for targeted applications
- Management of Carrier Gas flow has been modified to facilitate the optimization of spray stability in nanoflow LC applications
- Availability
 - All Tribrid models
- New features aligned with Orbitrap Exploris Series (OES) ICSW 3.1



Improvements in FAIMS Support

FAIMS Pro Duo Interface

- FAIMS Application Over a Wide Range of Chromatographic Flow Rates
 - Analyses with FAIMS Pro Duo Interface possible with the OptaMax NG ion source at flow rates up to 1 mL/min
 - FAIMS with HESI / APCI ion source type supported by Instrument Control Software

Orbitrap Tribrid Series ICSW 3.4

Ion Source Properties	
Ion Source Type	NSI
Spray Voltage	Static
Positive Ion (V)	1500
Negative Ion (V)	600
Gas Mode	Static
Ion Transfer Tube Temp (°C)	275
Use Ion Source Settings from Tune	<input type="checkbox"/>
FAIMS Mode	Standard Resolution
FAIMS Gas	Static
FAIMS Gas (L/min)	0

Ion Source Properties	
Ion Source Type	H-ESI
Spray Voltage	Static
Positive Ion (V)	3500
Negative Ion (V)	2500
Gas Mode	Static
Sheath Gas (Arb)	2
Aux Gas (Arb)	4.3
Ion Transfer Tube Temp (°C)	275
Vaporizer Temp (°C)	0
APPI Lamp	Not in Use
Use Ion Source Settings from Tune	<input type="checkbox"/>
FAIMS Mode	Standard Resolution
FAIMS Gas	Static
FAIMS Gas (L/min)	0

H-ESI
 APCI
 ESI

FAIMS is not supported for H-ESI source type.
 FAIMS is not supported for APCI source type.
 FAIMS is not supported for ESI source type.

Orbitrap Tribrid Series ICSW 3.5

Ion Source Properties	
Ion Source Type	NSI
Spray Voltage	Static
Positive Ion (V)	3500
Negative Ion (V)	2500
Gas Mode	Static
Ion Transfer Tube Temp (°C)	275
Use Ion Source Settings from Tune	<input type="checkbox"/>
FAIMS Mode	Standard Resolution
Total Carrier Gas Flow	Static
Total Carrier Gas Flow (L/min)	4.6

Ion Source Properties	
Ion Source Type	H-ESI
Spray Voltage	Static
Positive Ion (V)	3500
Negative Ion (V)	2500
Gas Mode	Static
Sheath Gas (Arb)	2
Aux Gas (Arb)	4.3
Ion Transfer Tube Temp (°C)	275
Vaporizer Temp (°C)	0
APPI Lamp	Not in Use
Use Ion Source Settings from Tune	<input type="checkbox"/>
FAIMS Mode	Standard Resolution
Total Carrier Gas Flow	Static
Total Carrier Gas Flow (L/min)	4.6

H-ESI
 APCI
 ESI

FAIMS only supported for NSI source type

FAIMS supported for ALL source types

Improvements in FAIMS Support

Optimized FAIMS CV Post-switching Delay Time for more Productive Targeted Acquisition

- Time necessary between the application of two consecutive CV settings to wait for the completion of the ion transfer through the FAIMS interface
- Previous implementation (ICSW 3.4 and earlier)
 - CV switching time dependent on ion transfer tube (ITT) geometry
MS with round bore ITT: 40 ms (e.g., Orbitrap Fusion)
MS with high capacity ITT: 25 ms (e.g., Orbitrap Eclipse)
- New implementation (ICSW 3.5)
 - CV switching time dependent on ion transfer tube geometry and magnitude of CV change
 - Fixed switching for CV steps above 2V and shorter time for smaller CV steps (following linear interpolant)

ITT Geometry	CV switching time		Instruments
	CV step \geq 2V	CV step \leq 1V	
Round bore ITT	40 ms	< 25 ms	Orbitrap Fusion, Orbitrap ID-X, Orbitrap IQ-X
High capacity ITT	25 ms	< 15 ms	Orbitrap Fusion Lumos, Orbitrap Eclipse

Improvements in FAIMS Support

Modified Management of Carrier Gas Flow To Address Spray Stability Issues at Nanoflow LC Rates

- FAIMS carrier gas flow needs to be user settable within a defined range to address spray stability issue
- Implementation in ICSW 3.4 and earlier based on two parameters controlling a single gas flow / line
 - Carrier Gas Flow - hidden parameter taking a fixed value depending on ion transfer tube (ITT) geometry
 - FAIMS Gas (or FAIMS User Set Gas) – User defined parameter accessible in Method Editor and Tune Page
- New implementation in ICSW 3.5
 - Carrier Gas Flow and FAIMS Gas are merged into a single parameter « Total Carrier Gas Flow » accessible in Method Editor and Tune
 - User settable ranges for Total Carrier Gas Flow
 - Round bore ITT: 3.5-7.7 L/min (default value: 4.6 L/min)
 - High capacity ITT: 0.7-4.3 L/min (default value: 1.2 L/min)
 - Total Carrier Gas Flow value for methods converted from ICSW 3.4 (or earlier)
 - Same ITT geometry: Default Total Carrier Gas Flow value + Previous User Set Gas value
 - Different ITT geometry: Default Total Carrier Gas Flow value

ICSW 3.4

FAIMS Mode	Standard Resolution
FAIMS Gas	Static
FAIMS Gas (L/min)	0

↓

ICSW 3.5

FAIMS Mode	Standard Resolution
Total Carrier Gas Flow	Static
Total Carrier Gas Flow (L/min)	4.6

Advanced Peak Determination (APD)

Broaden and Improved Implementation across Orbitrap Tribrid Family

- Aligned with Orbitrap Exploris Series ICSW 3.1
- Now Standard for all Orbitrap Tribrid products
- Application mode specific versions of peak annotation algorithm

Improved peak annotation of small molecules, e.g., halogenated compounds, reducing MS2 triggering on isotopes

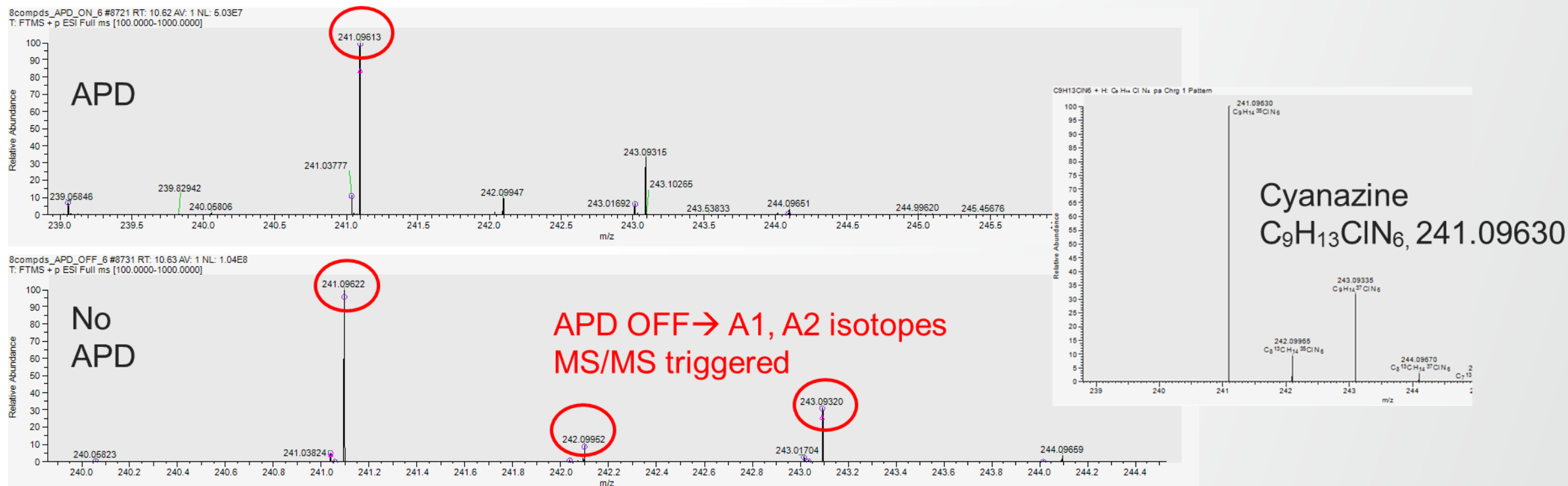

Support for Extended Low Mass Range m/z 40 in MSⁿ Scans

Enabling Identification of Additional Fragment Ions for Chemical Structure Elucidation

- Available for all Tribrid models
- Applied only to MSⁿ scans (no MS1)
- Applied to Orbitrap and Ion Trap scans

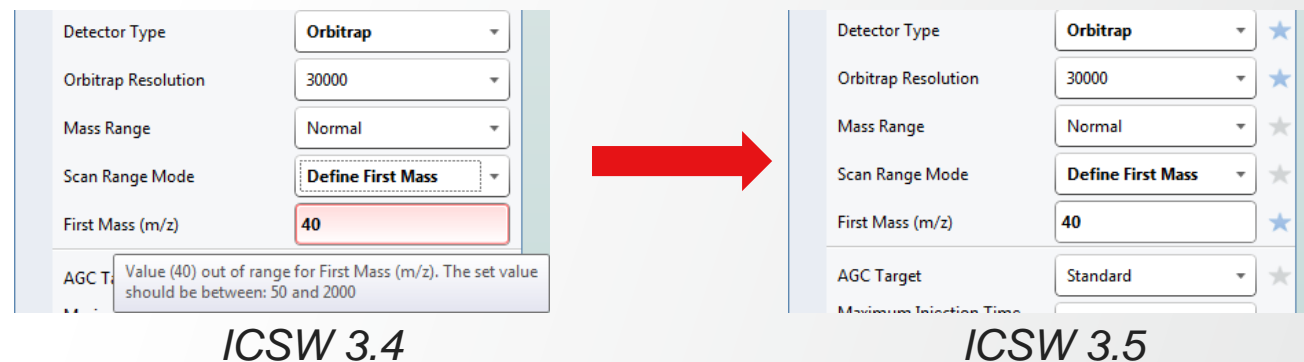

- Modified calibrations including ions below m/z 50. Application controlled by toggle in Diagnostics
 - Accessible under System>Low Mass Option>Turn On/Off Calibration Include Low Mass Ions
 - « On » by default for Orbitrap IQ-X. « Off » for all other Tribrid
 - List of required calibrations after turning on the option displayed in Diagnostics report

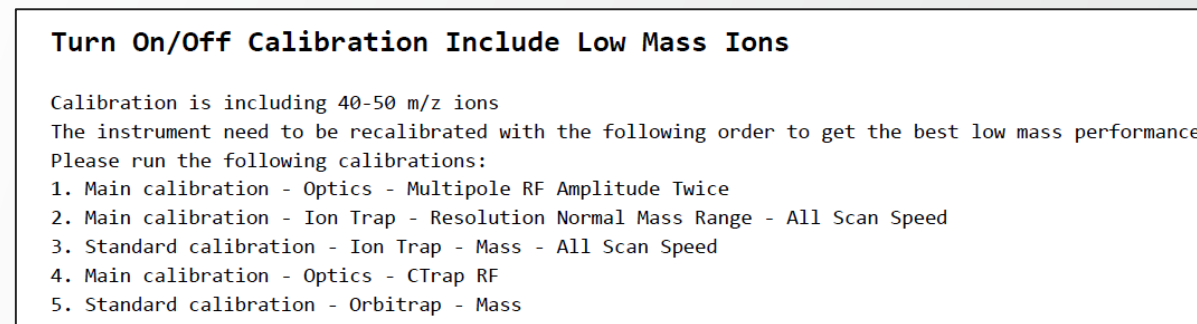
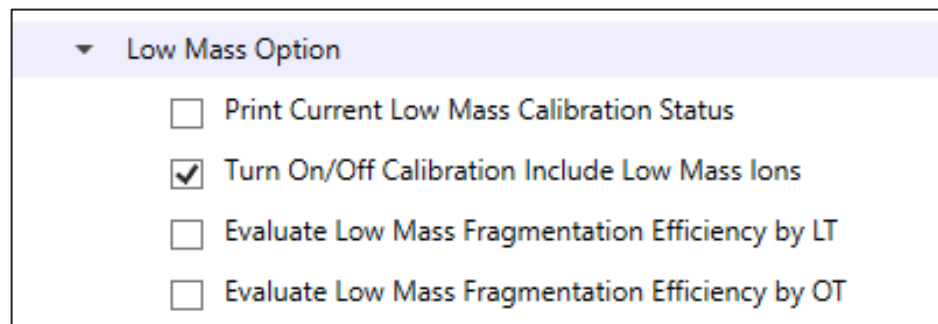

Support for Extended Low Mass Range m/z 40 in MS^n Scans

Enabling Identification of Additional Fragment Ions for Chemical Structure Elucidation

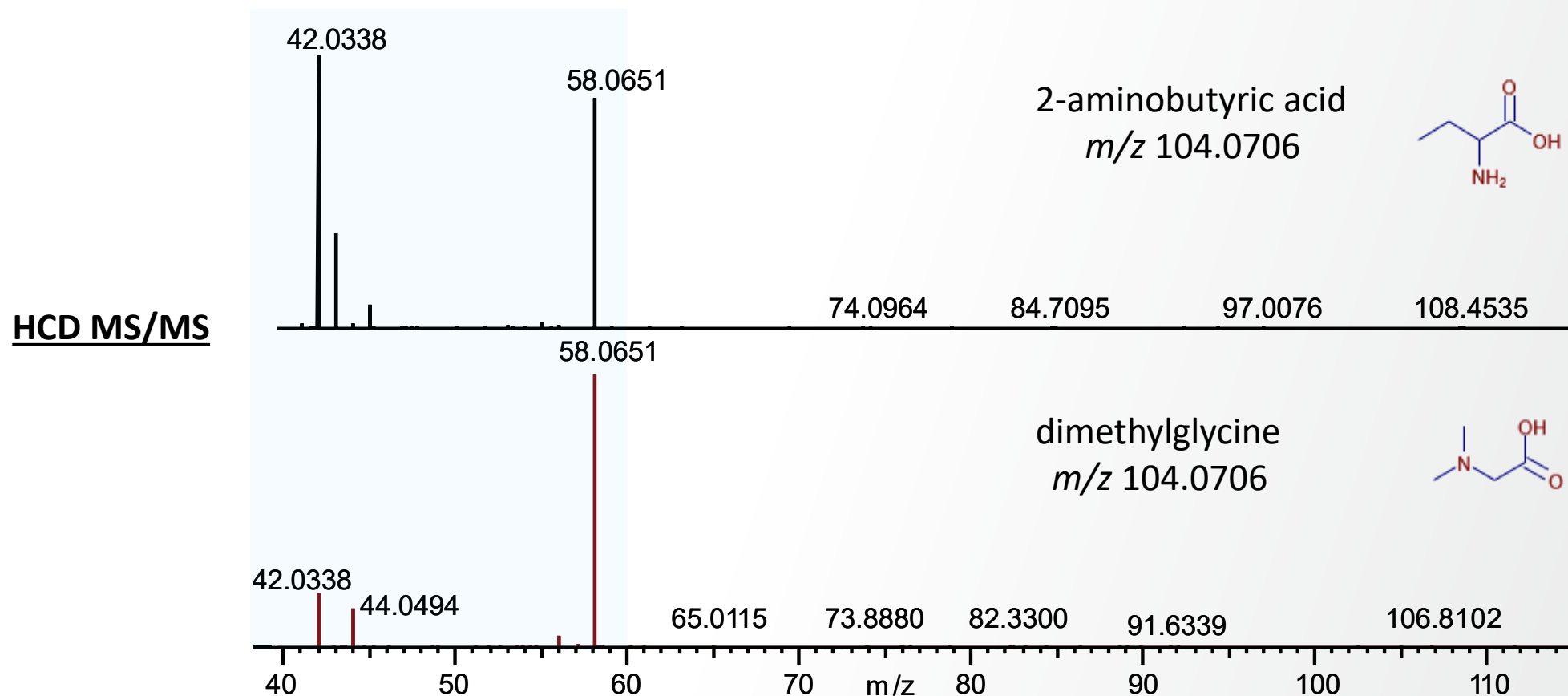

Fragments in mass range m/z 40-60 provide fragmentation ions distinguishing the two isomers

Support for Mild Trapping

Enabling Reduced Fragmentation of Fragile and Labile Compounds

- Aligned with OES ICSW 3.1; Available for all Tribrid models (small molecule application mode)
- New checkbox in Method Editor / toggle in Tune Diagnostics

ICSW 3.4

Method Editor

Settings

Application Mode: Peptide

Method Duration (min): 65

Infusion Mode: Liquid Chromatograph

Expected LC Peak Width (s): 30

Advanced Peak Determination:

Default Charge State: 3

Internal Mass Calibration: Off

ICSW 3.5

Method Editor

Settings

Application Mode: Peptide

Method Duration (min): 2

Infusion Mode: Liquid Chromatography

Expected LC Peak Width (s): 30

Advanced Peak Determination:

Default Charge State: 3

Internal Mass Calibration: Off

Orbitrap Fusion, Fusion Lumos, Eclipse

Diagnostics Toggle in Tune

▼ Mild Trapping

Toggle Mild Trapping During Tune Acquisitions (Small Molecule Mode)

Characterize Mild Trapping FlexMix

Orbitrap ID-X, IQ-X

Method Editor

Settings

Application Mode: Small Molecule

Method Duration (min): 65

Infusion Mode: Liquid Chromatograph

Expected LC Peak Width (s): 30

Advanced Peak Determination:

Default Charge State: 1

Enable Xcalibur AcquireX method modifications:

Method Editor

Settings

Application Mode: Small Molecule

Method Duration (min): 2

Infusion Mode: Liquid Chromatograph

Expected LC Peak Width (s): 6

Advanced Peak Determination:

Mild Trapping:

Default Charge State: 1

Enable Xcalibur AcquireX:

Method Editor

Settings

Method Duration (min): 2

Infusion Mode: Liquid Chromatograph

Expected LC Peak Width (s): 6

Advanced Peak Determination:

Mild Trapping:

Default Charge State: 1

Enable Xcalibur AcquireX:

Support for Mild Trapping

Enabling Reduced Fragmentation of Fragile and Labile Compounds

- Injection energy reduced upon injection into the IRM
- Significant decrease in fragmentation of most fragile compounds (up to 50%)
- Moderate decrease in overall signal ($\approx 20\%$)

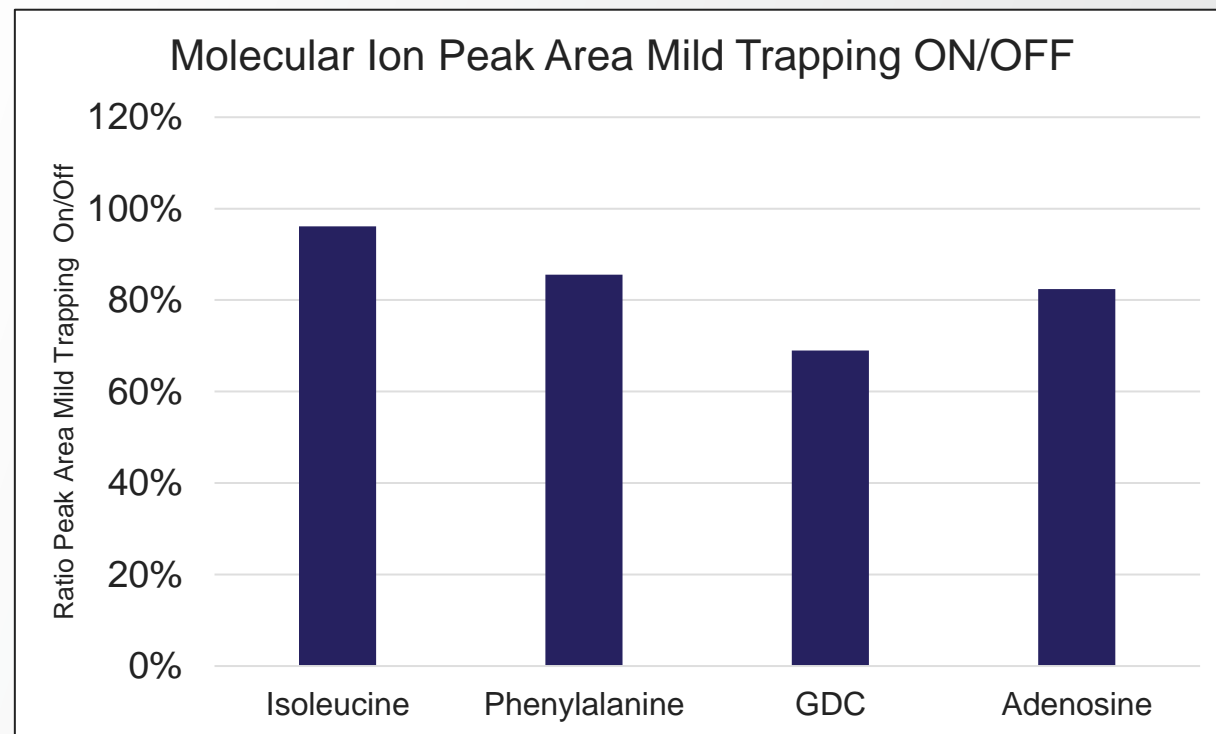
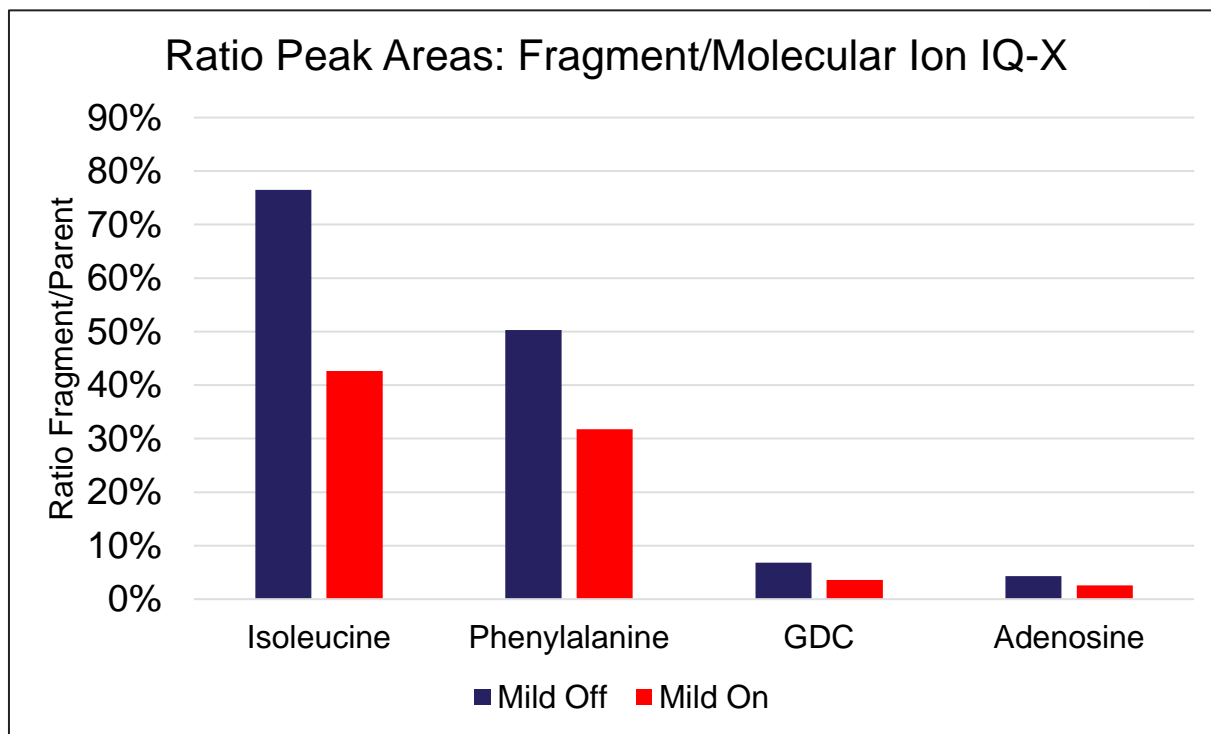

Support for Absolute and Normalized HCD Collision Energy

Enabling Expanded Control on Compound Fragmentation

- Aligned with Orbitrap Exploris Series ICSW 3.1
- New parameter in Method editor (and Tune/Define Scan) – HCD Collision Energy Type
 - Available as a property of MSn scan type (e.g., ddMS2, tMS2, or DIA)
 - Drive the definition of Absolute or Normalized value in HCD Collision Energy Field (reflected by displayed unit)
 - Control the type of HCD CE value used in Mass list table for targeted or directed acquisition but cannot be used for the definition of target specific HCD CE type

Collision Energy Mode: Fixed

HCD Collision Energy Type: Absolute

HCD Collision Energy (V): 40

Collision Energy Mode: Fixed

HCD Collision Energy Type: Normalized

HCD Collision Energy (%): 40

HCD Collision Energy Type: Normalized

HCD Collision Energy (%): Defined in Table

HCD Collision Energy Type: Absolute

HCD Collision Energy (V): Defined in Table

Mass List Table							ADD	DELETE	IMPORT	EXPORT
Compound	Formula	Adduct	m/z	z	HCD Collision Energy (%)					
1			524.265	1	30					
2			600	2	35					

Mass List Table							ADD	DELETE	IMPORT	EXPORT
Compound	Formula	Adduct	m/z	z	HCD Collision Energy (V)					
1			524.265	1	30					
2			600	2	35					

Support for Target Specific HCD CE in Targeted Mass Filter Table

Enabling More Flexibility in Directed Acquisition (DDA With Inclusion List)

- Aligned with Orbitrap Exploris Series ICSW 3.1
- New option in Method editor– Set Collision Energy per Compound
 - Available as a property of Targeted Mass Filter for HCD Activation Type
 - Further flexibility through possible combination with
 - Normalized or Absolute HCD CE
 - « Perform dependent scan on most intense ion if no targets are found »



Collision Energy Mode: Fixed

HCD Collision Energy Type: Normalized

HCD Collision Energy (%): Defined in Table

Compound	m/z	HCD Collision Energy (%)
1	524.265	30
2	600	35

Mass Tolerance: ppm

Low: 25

High: 25

Set Collision Energy per Compound

Perform dependent scan on most intense ion if no targets are found

Collision Energy Mode: Fixed

HCD Collision Energy Type: Normalized

HCD Collision Energy (%): 40

Targeted Mass Properties

MASS LIST

Mass List Type: m/z

Time Mode: Unscheduled

Include Intensity Threshold:

Compound	m/z
1	524.265
2	600

Mass Tolerance: ppm

Low: 25

High: 25

Set Collision Energy per Compound

Perform dependent scan on most intense ion if no targets are found

Support for Target Specific HCD CE in Targeted Mass Filter Table

Enabling More Flexibility in Directed Acquisition (DDA With Inclusion List)

Collision Energy Application		Case 1	Case 2	Case 3	Case 4
Set Collision Energy per Compound		FALSE <input type="checkbox"/>	FALSE <input type="checkbox"/>	TRUE <input checked="" type="checkbox"/>	TRUE <input checked="" type="checkbox"/>
Perform dependent scan on most intense ions if no targets are found		FALSE <input type="checkbox"/>	TRUE <input checked="" type="checkbox"/>	FALSE <input type="checkbox"/>	TRUE <input checked="" type="checkbox"/>
Collision Energy Mode	Targets (Table)	Fixed OR Stepped for all targets	Fixed OR Stepped for all (targets & additional ions)	Fixed for all targets (greyed out)	Fixed for all (targets & additional ions) (greyed out)
	Additional Ions	n.a.		n.a.	
HCD Collision Energy Type	Targets (Table)	Absolute OR Normalized for all targets	Absolute OR Normalized for all (targets & additional ions)	Absolute OR Normalized for all targets	Absolute OR Normalized for all (targets & additional ions)
	Additional Ions	n.a.		n.a.	
HCD Collision Energy Value	Targets (Table)	In Scan Property: 1 (frozen) value applied to all targets OR 2-5 (frozen) values applied to all targets	In Scan Property: 1 (frozen) value OR 2-5 (frozen) values applied to all (targets & additional ions)	In Scan Property: "Defined in Table" -> In Table: 1 individual value per target	In Table: 1 individual value per target
	Additional Ions	n.a.		n.a.	In Scan Property: 1 (frozen) value applied to all additional ions

Support for Target Specific HCD CE in Targeted Mass Filter Table

Enabling More Flexibility in Directed Acquisition (DDA With Inclusion List)

Collision Energy Application		Case 1	Case 2	Case 3	Case 4
Set Collision Energy per Compound		FALSE <input type="checkbox"/>	FALSE <input type="checkbox"/>	TRUE <input checked="" type="checkbox"/>	TRUE <input checked="" type="checkbox"/>
Perform dependent scan on most intense ions if no targets are found		FALSE <input type="checkbox"/>	TRUE <input checked="" type="checkbox"/>	FALSE <input type="checkbox"/>	TRUE <input checked="" type="checkbox"/>
Collision Energy Mode	Targets (Table)	Fixed OR Stepped for all targets	Fixed OR Stepped for all (targets & additional ions)	Fixed for all targets (greyed out)	Fixed for all (targets & additional ions) (greyed out)
	Additional Ions	n.a.		n.a.	
HCD Collision Energy Type	Targets (Table)	Absolute OR Normalized for all targets	Absolute OR Normalized for all (targets & additional ions)	Absolute OR Normalized for all targets	Absolute OR Normalized for all (targets & additional ions)
	Additional Ions	n.a.		n.a.	
HCD Collision Energy Value	Targets (Table)	In Scan Property: 1 (frozen) value applied to all targets OR 2-5 (frozen) values applied to all targets	In Scan Property: 1 (frozen) value OR 2-5 (frozen) values applied to all (targets & additional ions)	In Scan Property: "Defined in Table" -> In Table: 1 individual value per target	In Table: 1 individual value per target
	Additional Ions	n.a.		n.a.	

ADD
DELETE
IMPORT
EXPORT

#	Compound	m/z	
1		524.265	
2		600	

Mass Tolerance

Low

High

Set Collision Energy per Compound

Perform dependent scan on most intense ion if no targets are found

Collision Energy Mode

HCD Collision Energy Type

HCD Collision Energy (%)

Collision Energy Mode

HCD Collision Energy Type

HCD Collision Energies (%)

Collision Energy Mode

HCD Collision Energy Type

HCD Collision Energy (V)

Collision Energy Mode

HCD Collision Energy Type

HCD Collision Energies (V)

Support for Target Specific HCD CE in Targeted Mass Filter Table

Enabling More Flexibility in Directed Acquisition (DDA With Inclusion List)

Collision Energy Application		Case 1	Case 2	Case 3	Case 4
Set Collision Energy per Compound		FALSE <input type="checkbox"/>	FALSE <input type="checkbox"/>	TRUE <input checked="" type="checkbox"/>	TRUE <input checked="" type="checkbox"/>
Perform dependent scan on most intense ions if no targets are found		FALSE <input type="checkbox"/>	TRUE <input checked="" type="checkbox"/>	FALSE <input type="checkbox"/>	TRUE <input checked="" type="checkbox"/>
Collision Energy Mode	Targets (Table)	Fixed OR Stepped for all targets	Fixed OR Stepped for all (targets & additional ions)	Fixed for all targets (greyed out)	Fixed for all (targets & additional ions) (greyed out)
	Additional Ions	n.a.		n.a.	
HCD Collision Energy Type	Targets (Table)	Absolute OR Normalized for all targets	Absolute OR Normalized for all (targets & additional ions)	Absolute OR Normalized for all targets	Absolute OR Normalized for all (targets & additional ions)
	Additional Ions	n.a.		n.a.	
HCD Collision Energy Value	Targets (Table)	In Scan Property: 1 (frozen) value applied to all targets OR 2-5 (frozen) values applied to all targets	In Scan Property: 1 (frozen) value OR 2-5 (frozen) values applied to all (targets & additional ions)	In Scan Property: "Defined in Table" -> In Table: 1 individual value per target	In Table: 1 individual value per target
	Additional Ions	n.a.		n.a.	

Compound	m/z
1	524.265
2	600

Mass Tolerance: ppm
 Low: 25
 High: 25
 Set Collision Energy per Compound:
 Perform dependent scan on most intense ion if no targets are found:

Collision Energy Mode: Fixed
 HCD Collision Energy Type: Normalized
 HCD Collision Energy (%): 40

Collision Energy Mode: Fixed
 HCD Collision Energy Type: Absolute
 HCD Collision Energy (V): 40

Collision Energy Mode: Stepped
 HCD Collision Energy Type: Normalized
 HCD Collision Energies (%): 15,20

Collision Energy Mode: Stepped
 HCD Collision Energy Type: Absolute
 HCD Collision Energies (V): 15,20

Support for Target Specific HCD CE in Targeted Mass Filter Table

Enabling More Flexibility in Directed Acquisition (DDA With Inclusion List)

Collision Energy Application		Case 1	Case 2	Case 3	Case 4
Set Collision Energy per Compound		FALSE <input type="checkbox"/>	FALSE <input type="checkbox"/>	TRUE <input checked="" type="checkbox"/>	TRUE <input checked="" type="checkbox"/>
Perform dependent scan on most intense ions if no targets are found		FALSE <input type="checkbox"/>	TRUE <input checked="" type="checkbox"/>	FALSE <input type="checkbox"/>	TRUE <input checked="" type="checkbox"/>
Collision Energy Mode	Targets (Table)	Fixed OR Stepped for all targets	Fixed OR Stepped for all (targets & additional ions)	Fixed for all targets (greyed out)	Fixed for all (targets & additional ions) (greyed out)
	Additional Ions	n.a.		n.a.	
HCD Collision Energy Type	Targets (Table)	Absolute OR Normalized for all targets	Absolute OR Normalized for all (targets & additional ions)	Absolute OR Normalized for all targets	Absolute OR Normalized for all (targets & additional ions)
	Additional Ions	n.a.		n.a.	
HCD Collision Energy Value	Targets (Table)	In Scan Property: 1 (frozen) value applied to all targets OR 2-5 (frozen) values applied to all targets	In Scan Property: 1 (frozen) value OR 2-5 (frozen) values applied to all (targets & additional ions)	In Scan Property: "Defined in Table" -> In Table: 1 individual value per target	In Table: 1 individual value per target
	Additional Ions	n.a.		n.a.	

Compound	m/z	HCD Collision Energy (%)
1	524.265	30
2	600	35

Mass Tolerance: ppm
 Low: 25
 High: 25
 Set Collision Energy per Compound:
 Perform dependent scan on most intense ion if no targets are found:

Collision Energy Mode: Fixed
 HCD Collision Energy Type: Normalized
 HCD Collision Energy (%): Defined in Table

Compound	m/z	HCD Collision Energy (V)
1	524.265	30
2	600	35

Mass Tolerance: ppm
 Low: 25
 High: 25
 Set Collision Energy per Compound:
 Perform dependent scan on most intense ion if no targets are found:

Collision Energy Mode: Fixed
 HCD Collision Energy Type: Absolute
 HCD Collision Energy (V): Defined in Table

Support for Target Specific HCD CE in Targeted Mass Filter Table

Enabling More Flexibility in Directed Acquisition (DDA With Inclusion List)

Collision Energy Application		Case 1	Case 2	Case 3	Case 4
Set Collision Energy per Compound		FALSE <input type="checkbox"/>	FALSE <input type="checkbox"/>	TRUE <input checked="" type="checkbox"/>	TRUE <input checked="" type="checkbox"/>
Perform dependent scan on most intense ions if no targets are found		FALSE <input type="checkbox"/>	TRUE <input checked="" type="checkbox"/>	FALSE <input type="checkbox"/>	TRUE <input checked="" type="checkbox"/>
Collision Energy Mode	Targets (Table)	Fixed OR Stepped for all targets	Fixed OR Stepped for all (targets & additional ions)	Fixed for all targets (greyed out)	Fixed for all (targets & additional ions) (greyed out)
	Additional Ions	n.a.		n.a.	
HCD Collision Energy Type	Targets (Table)	Absolute OR Normalized for all targets	Absolute OR Normalized for all (targets & additional ions)	Absolute OR Normalized for all targets	Absolute OR Normalized for all (targets & additional ions)
	Additional Ions	n.a.		n.a.	
HCD Collision Energy Value	Targets (Table)	In Scan Property: 1 (frozen) value applied to all targets OR 2-5 (frozen) values applied to all targets	In Scan Property: 1 (frozen) value OR 2-5 (frozen) values applied to all (targets & additional ions)	In Scan Property: "Defined in Table" -> In Table: 1 individual value per target	In Table: 1 individual value per target In Scan Property: 1 (frozen) value applied to all additional ions
	Additional Ions	n.a.		n.a.	

Compound	m/z	HCD Collision Energy (%)
1	524.265	30
2	600	35

Mass Tolerance: ppm
 Low: 25
 High: 25
 Set Collision Energy per Compound
 Perform dependent scan on most intense ion if no targets are found

Collision Energy Mode: Fixed
 HCD Collision Energy Type: Normalized
 HCD Collision Energy (%): 40

Compound	m/z	HCD Collision Energy (V)
1	524.265	30
2	600	35

Mass Tolerance: ppm
 Low: 25
 High: 25
 Set Collision Energy per Compound
 Perform dependent scan on most intense ion if no targets are found

Collision Energy Mode: Fixed
 HCD Collision Energy Type: Absolute
 HCD Collision Energy (V): 40

Support for Chromeleon

Enabling Orbitrap Tribrid Series ICSW 3.5 to run Under Chromeleon 7.2.10 MUd

- Aligned with Orbitrap Exploris Series ICSW 3.1
 - Chromeleon CDS software can substitute Xcalibur to control Orbitrap Tribrid MS with GMP compliance with audit trail compatibility, allowing:
 - Mass spectrometer to be Tuned
 - Acquisition methods to be prepared
 - Acquisition to be performed from Tune page
 - Series of analyses to be run (Sequences)
 - Compatibility fully tested with Orbitrap IQ-X and using Foundation 3.1 SP8
- The Chromeleon Driver Compatibility matrix is updated when other Tribrid Series models and configurations are fully tested. For more information and to view the compatibility matrix, sign on to <https://support.thermoinformatics.com/downloads/default.aspx>, and then select **Chromeleon > Chromeleon > Related Drivers > Driver Compatibility Matrix**.*
- Limitations
 - AcquireX functionalities are not supported by Chromeleon
 - Tune page needs to be opened from Chromeleon when Chromeleon is installed

Thank you

<https://www.thermofisher.com/fr/fr/home/industrial/mass-spectrometry/liquid-chromatography-mass-spectrometry-lc-ms/lc-ms-software/lc-ms-data-acquisition-software.html>

planet.orbitrap@thermofisher.com

