

NOTICE: This document contains references to Varian. Please note that Varian, Inc. is now part of Agilent Technologies. For more information, go to www.agilent.com/chem.



Varian, Inc.
2700 Mitchell Drive
Walnut Creek, CA 94598-1675/USA

240-MS GC/MS Ion Trap Mass Spectrometer

Hardware Operation Manual



All rights reserved including the right of reproduction in whole or in part in any form. This document may be electronically reproduced, distributed, or printed in its entirety provided this copyright and statement are attached. Any modification or any other reproduction, distribution, or use of this document or portions hereof is strictly prohibited without the express written permission of Varian, Inc.

COPYRIGHT 2008. All rights reserved.



Declaration of Conformity

We hereby Declare that the equipment listed below complies with the requirements of:

The Low Voltage Directive 73/23/EEC (93/68/EEC)

The EMC Directive 89/336/EEC (92/31/EEC and 93/68/EEC)

Applicable Standards

LVD EN 61010-1

EMC EN 61326

Type of Equipment:

Model: 240-MS

Authorized Representative in the EU

Print Name: G. A. Wassink

Company Name: Varian B.V.

Signed: 

Address: Herculesweg 8

Position: Quality Manager

P.O. Box 8033

Date: June 24, 2008

4330 EA Middelburg

The Netherlands

Telephone: +31(0) 118 671 000

Fax: +31(0) 118 633 118

Manufacturer

Print Name: Mike Enock

Company Name: Varian, Inc.

Signed: 

Address: 2700 Mitchell Drive

Position: General Manager

Walnut Creek, California 94598

USA

Date: June 24, 2008

Telephone: 925-939-2400

Fax: 925-945-2168



VARIAN

Quality Systems At Varian, Inc.

The ISO 9000 series standards were created in Geneva in 1987 to cut through a morass of conflicting quality definitions. These standards define a model for quality assurance systems in product design, development, manufacturing, installation, service, and customer support. They are now the worldwide quality assurance benchmark used to gauge the strength of a company's commitment to quality, and the value of its quality systems.

Various organizations around the world, such as the British Standards Institution (BSI), provide certified, objective auditors to scrutinize quality procedures, product development, manufacturing processes, and customer satisfaction programs. No company can claim ISO 9000 series registration unless it receives a stamp of approval from the demanding quality assessors of BSI or similar accredited examining body. ISO 9000 series registration constitutes an objective third-party report to determine the level of a supplier's commitment to quality.

In 1992, Varian, Inc., Analytical Instruments became registered to the most comprehensive of the ISO 9000 series standards — ISO 9001. ISO 9001 registration means that every stage of our quality system, including product development, manufacturing, final test, shipping, and parts and supplies has been rigorously examined against the most exacting set of internationally recognized standards. It means we live up to a standard of quality that you can count on today, and into the future. Our Quality System has received ISO 9001 certification number FM21797.

The quality systems that earned us ISO 9001 registration have direct benefits for our customers:

- ◆ We can speed instruments to you faster than ever before. Emergency orders can be processed even faster.
- ◆ We fill your orders promptly and completely.
- ◆ We have implemented a system of continuous feedback from our customers — we are aware of your needs today and tomorrow.
- ◆ We have improved your productivity by cutting systems failure rates in half and speeding service response time.
- ◆ We have embedded continuous improvement into the fabric of our organization so that we can achieve even higher levels of quality in the future.
- ◆ We are embedding GLP requirements into our products and services to help you meet your regulatory compliance requirements.

ISO 9001 registration is not enough. For us, quality is defined by our customers. We are not satisfied unless you are satisfied. We are striving to understand customer needs, using independent surveys, user groups, customer advisory boards, and our “Hallmark of Quality” response program, in addition to individual face-to-face customer contact. Our products and our processes are configured to meet those needs.

We know that you are seeking more than the most advanced processes and top-notch applications expertise. You want to join forces with a partner committed to delivering world-class quality, reliability, and value — on time, every time.

Our overriding aim is to be that partner.



Varian, Inc. Analytical Instrument Warranty

Hardware Products

All analytical instruments sold by Varian, Inc. are warranted to be free from defects in material and workmanship for the periods specified and in accordance with the terms on the face of Varian's quotation or as otherwise agreed upon in writing between Varian and the Customer. The warranty period begins on the date of **shipment** from Varian to the original Customer. However, where installation is paid for by the Customer or included in the purchase price, the warranty period begins upon completion of installation. If the Customer schedules **installation** to start later than 30 days after delivery or if such delay is caused through the Customer's inability to provide adequate facilities or utilities or through failure to comply with Varian's reasonable pre-installation instructions or through other omissions by Customer, then the warranty period starts on the 31st day from date of shipment. Moreover Varian will charge the Customer for labor and other expenses involved in making multiple or follow-up installation service calls.

Software Products

Where software is provided within the frame of a license agreement concluded between the Customer and Varian, any warranty shall be strictly in accordance with the terms of such agreement.

In the absence of a license agreement and unless an alternate warranty period is agreed upon in writing between Varian and the Customer, the warranty period is as specified on the face of Varian's quotation. Varian warrants such software products, if used with and properly installed on Varian hardware or other hardware as specified by Varian to perform as described in the accompanying Operator's Manual and to be substantially free of those defects which cause failure to execute respective programming instructions; however, Varian does not warrant uninterrupted or error-free operation.

Remedies

The sole and exclusive remedy under hardware warranty shall be **repair** of instrument malfunctions which in Varian's opinion are due or traceable to defects in original materials or workmanship or, at Varian's option, **replacement** of the respective defective parts, provided that Varian may as an alternative elect to **refund** an equitable portion of the purchase price of the instrument or accessory.

Repair or replacement under warranty does not extend the original warranty period.

Repair or replacement under warranty claims shall be made in Varian's sole discretion either by sending a Customer Support Representative to the site or by authorizing the Customer to return the defective accessory or instrument to Varian or to send it to a designated service facility. The Customer shall be responsible for loss or damage in transit and shall prepay shipping cost. Varian will return the accessory or instrument to the Customer prepaid and insured. Claims for loss or damage in transit shall be filed by the Customer. To correct software operation anomalies, Varian will issue software revisions where such revisions exist and where, in Varian's opinion, this is the most efficient remedy.

Limitation of Warranty

This **warranty does not cover** software supplied by the Customer, equipment and software warranted by another manufacturer or replacement of expendable items and those of limited life, such as but not limited to: Filters, glassware, instrument status lamps, source lamps, septa, columns, fuses, chart paper and ink, nebulizers, flow cells, pistons, seals, fittings, valves, burners, sample tubes, probe inserts, print heads, glass lined tubing, pipe and tube fittings, variable temperature dewars, transfer lines, flexible discs, magnetic tape cassettes, electron multipliers, filaments, vacuum gaskets, seats and all parts exposed to samples and mobile phases.

This **warranty shall be void** in the event of accident, abuse, alteration, misuse, neglect, breakage, improper operation or maintenance, unauthorized or improper modifications or tampering, use in an unsuitable physical environment, use with a marginal power supply or use with other inadequate facilities or utilities. Reasonable care must be used to avoid hazards.

This warranty is expressly in lieu of and excludes all other express or implied warranties, including but not limited to warranties of merchantability and of fitness for particular purpose, use or application, and all other obligations or liabilities on the part of Varian, unless such other warranties, obligations or liabilities are expressly agreed to in writing by Varian.

Limitation of Remedies and Liability

The remedies provided herein are the sole and exclusive remedies of the Customer. In no case will Varian be liable for incidental or consequential damages, loss of use, loss of production or any other loss incurred.



VARIAN

Qualitätssysteme bei Varian, Inc.

Die Standards der ISO 9000 Serien wurden 1987 in Genf mit dem Ziel geschaffen, das Durcheinander gegensätzlicher Qualitätsbestimmungen zu entwirren. Diese Standards legen ein Modell für Qualitätssicherungssysteme hinsichtlich Produktdesign, Entwicklung, Herstellung, Installation, Service und Kundenbetreuung fest. Sie sind nun die weltweiten Maßstäbe der Qualitätssicherung, die die Anstrengungen eines Unternehmens bezüglich der Qualität und der Bedeutung seiner Qualitätssysteme messen.

Verschiedene Organisationen in der ganzen Welt, wie die British Standards Institution (BSI), stellen ausgebildete, objektive Prüfer zur Begutachtung von Qualitätsmaßnahmen, Produktentwicklung, Herstellungsprozessen und von Programmen zur Erforschung der Kundenzufriedenheit zur Verfügung. Kein Unternehmen kann die ISO 9000 Registrierung beantragen, ohne die Genehmigung von den beauftragten Qualitätsgutachtern der BSI oder einer ähnlichen akkreditierten Stelle erhalten zu haben. Die ISO 9000 Registrierung bildet einen objektiven Bericht von dritter Seite, um den Grad der Qualitätsanstrengung eines Lieferanten zu bestimmen.

1992 wurden die Varian, Inc., Analytical Instruments nach den umfassendsten Standards der ISO 9000 Serie registriert — ISO 9001. Die ISO 9001 Registrierung bedeutet, daß jedes Stadium unseres Qualitätssystems, einschließlich Produktentwicklung, Herstellung, Endkontrolle, Versand, sowie Teile und Zubehör rigoros gegen die anspruchsvollste Serie international anerkannter Standards geprüft worden ist. Das bedeutet, daß wir einen Qualitätsstandard bieten, auf den Sie heute und in Zukunft rechnen können. Unser Qualitätssystem hat die ISO 9001 Zertifikatnummer FM21797 erhalten.

Die Qualitätssysteme der ISO 9001 Registrierung haben für unsere Kunden direkte Vorteile:

- ◆ Wir können Instrumente schneller denn je zu Ihnen schicken. Eilbestellungen werden noch schneller durchgeführt.
- ◆ Wir erfüllen Ihre Bestellungen pünktlich und vollständig.
- ◆ Wir haben ein System kontinuierlichen Informationsrückflusses von unseren Kunden aufgebaut—wir kennen Ihre Anforderungen von heute und von morgen.
- ◆ Wir haben Ihre Produktivität durch Halbierung der Systemfehlerraten und durch Verkürzung unserer Reaktionszeit im Service verbessert.
- ◆ Wir haben kontinuierliche Verbesserungen in unserer Organisationsstruktur verankert, so daß wir künftig eine noch höhere Qualität erreichen können.
- ◆ Wir haben die GLP Anforderungen in unsere Produkte und Dienstleistungen eingeführt, um Ihnen bei der Erfüllung Ihres behördlichen Abnahmeprotokolls zu helfen.

Die ISO 9001 Registrierung ist nicht genug. Für uns wird Qualität durch unsere Kunden definiert. Wir sind nicht zufrieden, wenn Sie es nicht auch sind. Wir bemühen uns, die Anforderungen unserer Kunden durch unabhängige Untersuchungen, Anwendergruppen, Kundenberatungsgremien und unser Antwortprogramm "Gütesiegel der Qualität" zu verstehen, zusätzlich zu persönlichen Kundenkontakten. Unsere Produkte und unsere Prozesse sind so gestaltet, daß sie diese Anforderungen erfüllen.

Wir wissen, daß Sie mehr als fortschrittliche Prozesse und ausgezeichnetes Anwendungswissen suchen. Sie suchen einen Partner, der Qualität von Weltklasse, Verlässlichkeit und Nutzen für Sie liefert—pünktlich und jederzeit.

Unser oberstes Ziel ist, für Sie dieser Partner zu sein.



Varian, Inc. Analytical Instrument Garantie

Hardwareprodukte

Es wird garantiert, daß alle von Varian, Inc. verkauften analytischen Instrumente für die angegebene Zeitdauer und in Übereinstimmung mit den „Allgemeinen Lieferbedingungen“ oder anderen schriftlichen Zusagen zwischen Varian und dem Kunden frei von Material- und Herstellungsfehlern sind. Die Garantiezeit beginnt mit dem **Versanddatum** von Varian zum Originalkunden. Wenn die Installation vom Kunden bezahlt oder im Verkaufspreis eingeschlossen ist, beginnt die Garantiezeit nach der abgeschlossenen Installation. Wenn der Kunde den **Installationsbeginn** später als 30 Tage nach erfolgter Lieferung ansetzt, oder wenn die Verzögerung dadurch verursacht wird, daß der Kunde nicht den ausreichenden Platz oder die Versorgungseinrichtungen beschafft oder Varian's berechnete Anweisungen zur Installationsvorbereitung nicht einhält oder andere Versäumnisse des Kunden vorliegen, dann beginnt die Garantiezeit am 31. Tag nach dem Versanddatum. Darüber hinaus wird Varian dem Kunden den Arbeitsaufwand und andere Unkosten durch mehrfache oder fortgesetzte Installationsanforderungen berechnen.

Softwareprodukte

Wo Software innerhalb des Rahmens eines Lizenzabkommens zwischen dem Kunden und Varian geliefert wird, wird die Garantie genau entsprechend der zeitlichen Abmachung eingehalten.

Besteht kein Lizenzabkommen und ist keine alternative Garantiezeit schriftlich zwischen Varian und dem Kunden festgelegt, gilt die Garantiezeit der „Allgemeinen Lieferbedingungen“. Varian garantiert für solche Softwareprodukte, die mit Varian's Hardware benutzt und richtig installiert sind oder zur Ausführung mit anderer von Varian angegebener Hardware, wie sie in der beigelegten Bedienungsanleitung beschrieben ist, daß sie im wesentlichen frei von solchen Defekten sind, die Fehler bei der Ausführung der jeweiligen Programmieranweisungen verursachen; Varian garantiert jedoch keine ununterbrochene oder fehlerfreie Arbeitsweise.

Abhilfen

Die einzige und ausschließliche Abhilfe in der Hardwaregarantie wird die **Reparatur** der Instrumentstörungen sein, die sich nach Varian's Ansicht auf Defekte in den Originalteilen oder bei der Herstellung zurückführen läßt oder, nach Varian's Wahl, der **Austausch** der entsprechenden defekten Teile oder die **Erstattung** eines fairen Teils des Kaufpreises des Instruments oder Zubehörs, vorausgesetzt, daß sich Varian alternativ dafür entscheidet.

Reparatur oder Austausch unter Garantie verlängert nicht die ursprüngliche Garantiezeit.

Reparatur oder Austausch unter Garantieansprüchen soll in Varian's ausschließlichem Ermessen entweder durch einen Serviceingenieur beim Kunden oder durch Ermächtigung des Kunden zum Einschicken des defekten Zubehörs oder Instruments an Varian oder einen Servicestützpunkt erfolgen. Der Kunde übernimmt die Verantwortung für Verlust oder Beschädigung im Transit und hat die Versandkosten im voraus zu bezahlen. Varian wird das Zubehör oder Instrument vorausbezahlt und versichert zum Kunden zurückschicken. Ansprüche für Verlust oder Beschädigung im Transit hat der Kunde zu erheben. Zur Korrektur von Anomalien des Softwarebetriebs wird Varian Software-Neuausgaben ausgeben, sofern Revisionen existieren und dies die beste Abhilfe ist.

Garantieeinschränkungen

Diese **Garantie erfaßt nicht** vom Kunden bereitgestellte Software, Ausrüstungen und Software, die von anderen Herstellern garantiert werden oder den Austausch entbehrlicher Teile und solcher von begrenzter Lebensdauer wie diese, aber nicht darauf beschränkt: Filter, Glaswaren, Instrument Statuslampen, Lampenquellen, Septen, Säulen, Sicherungen, Schreiberpapier und Tinte, Zerstäuber, Flußzellen, Kolben, Dichtungen, Fittings, Ventile, Brenner, Probenröhrchen, Sondeneinsätze, Druckköpfe, glausgekleidetes Rohr, Leitungs- und Rohrfittings, Dewars für variable Temperaturen, Transferleitungen, flexible Disketten, Magnetbandkassetten, elektronische Vervielfacher, Heizdrähte, Vakuum Gaskets, Sitzflächen und alle Teile, die den Proben und mobilen Phasen ausgesetzt sind.

Diese **Garantie erlischt** bei eingetretenem Unfall, falscher Benutzung, Umbau, Mißbrauch, Vernachlässigung, Bruch, falscher Benutzung oder falscher Wartung, unbefugten oder falschen Modifikationen oder Basteleien, Benutzung in ungeeigneter physikalischer Umgebung, Benutzung mit marginaler Stromversorgung oder Benutzung mit anderen ungenügenden Einrichtungen oder Versorgungsungen. Mit vernünftiger Sorgfalt müssen Gefahren vermieden werden.

Diese **Garantie steht ausdrücklich anstelle von allen anderen angedeuteten Garantien und schließt sie aus, einschließlich, aber nicht beschränkt auf Garantien der Verkäuflichkeit und Eignung für einen besonderen Zweck, Gebrauch oder Anwendung und allen anderen Verpflichtungen oder Haftungen von Varian's Seite, wenn nicht solche Garantien, Verpflichtungen oder Haftungen ausdrücklich schriftlich mit Varian vereinbart wurden.**

Beschränkung der Hilfen und Haftung

Die hier gegebenen Hilfen sind einzig und allein Sache des Kunden. In keinem Fall wird Varian für versehentliche oder sich ergebende Schäden wie **Nutzungsverlust, Produktionsverlust oder jeden anderen Verlust haften.**



VARIAN

Systemes de qualité chez Varian, Inc.

Les normes ISO série 9000 ont été créées à Genève, en 1987, pour remédier à la confusion dans la définition des normes de qualité. Ces normes définissent un modèle de contrôle de qualité dans le domaine de la conception produit, du développement, de la production, des installations, des services et du support client. Elles constituent à présent la référence mondiale en matière de contrôle de qualité utilisée aux fins d'évaluation du niveau d'engagement d'une entreprise dans ce domaine et la valeur de ses systèmes de qualité.

Plusieurs organisations de par le monde, telle la British Standards Institution (BSI) offrent les services d'auditeurs qualifiés et objectifs, chargés d'examiner les procédures de qualité, le développement de produit, les procédés de fabrication et les programmes de satisfaction du client.

Aucune société ne peut se prévaloir de l'homologation ISO 9000, sans avoir reçu l'approbation des évaluateurs rigoureux de la BSI ou d'un organisme accréditif similaire. L'homologation ISO 9000 constitue une évaluation objective d'un tiers afin de déterminer le niveau d'engagement d'un fournisseur dans le domaine de la qualité.

En 1992, Varian, Analytical Instruments a reçu l'homologation ISO 9001, normes des plus complètes de la série ISO 9000. En d'autres termes, chaque étape du processus de qualité, notamment le développement produit, la fabrication, le test final, l'expédition et les fournitures de pièces a été soumis à un contrôle rigoureux par rapport à des normes extrêmement strictes, reconnues au niveau international. Nous sommes donc à même de vous garantir et de maintenir un niveau de qualité. Lesdites procédures ont reçu l'homologation ISO 9001 numéro FM21797.

Les systèmes de qualité qui ont reçu l'homologation ISO 9001 présentent des avantages directs pour nos clients :

- ◆ Nous sommes en mesure de vous livrer les instruments et de traiter les commandes en urgence dans des délais record.
- ◆ Nous répondons pleinement et de manière rapide à vos commandes.
- ◆ Nous avons mis en place un système de feedback continu de la part de nos clients et sommes conscients de vos attentes présentes et futures.
- ◆ Nous avons amélioré votre productivité en réduisant de moitié les Temps de panne et en accélérant les temps de réponse.
- ◆ Nous avons apporté des améliorations constantes au sein de notre structure, afin d'atteindre des niveaux de qualité optima, à l'avenir.
- ◆ Nos produits et services reflètent les exigences BPL pour vous permettre de répondre aux impératifs de respect de la réglementation.

Toutefois, nous ne nous contentons pas de l'homologation ISO 9001. Pour nous, la qualité est définie par nos clients. Nous ne sommes satisfaits que lorsque nos clients le sont. Nous nous efforçons de comprendre vos besoins, à l'aide d'évaluations externes, de groupes d'utilisateurs, de comités de conseil clients, et de notre programme "Hallmark of Quality", outre les contacts directs que nous établissons avec chacun de nos clients. Nos produits et nos procédés sont conçus pour répondre à vos attentes.

Nous n'ignorons pas que vous recherchez plus que des processus évolués et un savoir-faire d'exception dans le domaine des applications. Vous souhaitez conjuguer vos forces avec un partenaire s'étant engagé à offrir une qualité, une fiabilité et une valeur optimales, au moment où il faut et quand il faut.

Notre principal objectif : devenir votre partenaire !



Garantie des instruments d'analyse Varian, Inc.

Matériel

Les instruments d'analyse vendus par Varian, Inc. sont garantis exempts de défauts de matière et de fabrication, pour les périodes spécifiées et conformément aux conditions mentionnées sur le recto du devis ou aux termes de tout autre accord écrit intervenu entre Varian et le client. La période de garantie commence à compter de la date de **livraison** de Varian au client d'origine. Cependant, lorsque le client a acquitté les frais d'installation ou que celle-ci est incluse dans le prix d'achat, la période de garantie commence à compter de l'achèvement de l'installation. Si le client prévoit le début de **l'installation** au-delà de 30 jours après la livraison ou si ledit retard est dû à l'inaptitude du client à mettre à disposition les installations ou services ou au non respect des instructions de pré-installation de Varian ou à la suite desdites négligences du client, la période de garantie commence le 31^{ème} jour à compter de la date de livraison. De plus, Varian fera supporter au client tout frais de main d'oeuvre et autres coûts résultant de multiples appels téléphoniques aux fins de suivi de l'installation.

Logiciel

Pour tout logiciel faisant l'objet d'un accord de licence conclu entre le client et Varian, la garantie sera strictement limitée aux termes dudit accord.

En l'absence d'accord de licence et sauf accord écrit sur tout autre période de garantie entre Varian et le client, la période de garantie est telle que spécifiée sur le recto du devis de Varian. Sous réserve de leur installation et de leur utilisation correcte sur le matériel Varian ou tout autre matériel, tel que spécifié, Varian garantit le fonctionnement tel que décrit dans le manuel d'utilisation fourni avec le matériel et l'absence de défauts entraînant l'impossibilité d'exécuter des instructions de programmation respectives. Toutefois, Varian ne garantit pas un fonctionnement sans interruption et sans erreurs.

Recours

Le seul et unique recours relatif à la garantie du matériel se limite à la **réparation** suite à un mauvais fonctionnement de l'instrument, qui, de l'avis de Varian, est dû à des défauts des pièces d'origine ou de la fabrication, ou, à la discrétion de Varian, au **remplacement** des pièces défectueuses en question, sous réserve du choix de Varian de **rembourser** une part raisonnable du prix d'achat de l'instrument ou de l'accessoire.

La réparation ou le remplacement sous garantie n'étend pas la période de garantie originale.

La réparation ou le remplacement, aux termes d'un recours, est laissé à l'entière discrétion de Varian, soit par l'envoi d'un technicien de maintenance sur le site du client, soit en autorisant le client à retourner l'accessoire ou l'instrument défectueux à Varian, voire à l'envoyer à un service de maintenance désigné.

Le client assumera la responsabilité de toute perte ou sinistre lors du transport et règlera à l'avance les frais de transport. Varian renverra l'accessoire ou l'instrument au client en port payé et assuré. Toute réclamation résultant d'une perte ou d'un sinistre intervenu lors du transport devra être faite par le client. Aux fins de correction des anomalies de fonctionnement du logiciel, Varian diffusera des mises à jour des logiciels, le cas échéant, et si de l'avis de Varian, elles constituent la mesure corrective la plus appropriée en la matière.

Limitation de garantie

Cette **garantie ne couvre pas** le logiciel fourni par le Client, les équipements ou logiciels garantis par un autre fabricant ni le remplacement des pièces consommables ou présentant une durée de vie limitée, notamment : filtres, verres, indicateurs d'état de l'instrument, lampes source, septa, colonnes, fusibles, papier graphique et encre, nébuliseurs cellules, pistons, joints, raccords, vannes, brûleurs, tubes d'échantillonnage, inserts de sonde, têtes d'impression, tubes à garniture de verre, dewars, lignes de transfert, disquettes, cassettes magnétiques, multiplicateurs d'électron, filaments, joints hermétiques, isolant et toutes les pièces en contact avec des échantillons et des phases mobiles.

Ladite garantie est nulle en cas d'accident, de mauvaise utilisation, d'altération, de négligence, de bris, d'utilisation, maintenance voire de modifications inappropriées, d'utilisation dans un environnement inadapté, d'utilisation avec une alimentation marginale ou d'autres installations ou services inappropriés. Un certain nombre de précautions doivent être prises pour éviter tout accident.

Ladite garantie se substitue et exclut expressément toute garantie expresse ou tacite, y compris mais ne se limitant pas aux garanties relatives à la qualité marchande du programme et la garantie de son aptitude à une utilisation ou une application particulière, ainsi que toutes les autres obligations ou engagements de la part de Varian, à moins que lesdites garanties, obligations ou engagements aient fait expressément l'objet d'un accord écrit de Varian.

Limitations de garantie et de la responsabilité :

Les recours exclusifs du client sont expressément énoncés aux présentes. En aucun cas, Varian ne sera tenu pour responsable de tout dommage provenant de l'utilisation ou en découlant, de toute impossibilité d'utilisation ou de déficit de production ou de tout autre perte y afférent.



VARIAN

I sistemi di qualità della Varian, Inc.

La serie degli standard ISO 9000 è stata presentata nel 1987 a Ginevra con lo scopo di mettere ordine in un groviglio di definizioni contrastanti sulla qualità. Tali standard definiscono un modello che assicura la qualità nella progettazione, nello sviluppo, nella fabbricazione, nell'installazione e nella manutenzione dei prodotti nonché nel servizio assistenza clienti. Oggi come oggi essi costituiscono il punto di riferimento, a livello mondiale, ai fini della valutazione dell'impegno delle diverse aziende sul fronte della qualità e della validità dei sistemi di qualità da esse adottati.

Diverse organizzazioni internazionali, come la British Standard Institution (BSI), dispongono d'ispettori certificati e imparziali per la valutazione delle procedure di qualità, dello sviluppo dei prodotti, dei processi di fabbricazione e dei programmi di soddisfazione del cliente. Nessuna azienda può asserire d'essere in possesso della certificazione ISO 9000 finché non dispone del marchio d'approvazione concesso dai rigorosi ispettori di qualità della BSI o di altri enti di controllo riconosciuti. La certificazione di conformità agli standard ISO 9000 costituisce un'attestazione imparziale di terzi del grado d'impegno di una determinata azienda nei confronti della qualità.

Nel 1992 la Varian, Inc., Analytical Instruments ha ottenuto l'omologazione allo standard più completo della serie ISO 9000, l'ISO 9001. L'omologazione ISO 9001 significa che ogni singola fase del nostro sistema di qualità - compresi lo sviluppo del prodotto, la fabbricazione, le prove finali, la spedizione, i componenti e le forniture - è stata rigorosamente esaminata a fronte della serie più esigente di standard riconosciuti a livello mondiale, il che significa che rispondiamo pienamente ad uno standard qualitativo sul quale il cliente può contare oggi come nel futuro. Il nostro Sistema di Qualità ha ottenuto la certificazione ISO 9001 col numero FM21797.

I sistemi di qualità per i quali abbiamo ottenuto l'omologazione ISO 9001 comportano dei vantaggi diretti per i nostri clienti, ovvero:

- ◆ Siamo in grado di consegnare gli strumenti più rapidamente rispetto al passato, con la possibilità di evadere le richieste d'emergenza con una rapidità ancora maggiore.
- ◆ Gli ordini vengono evasi tempestivamente ed in modo completo.
- ◆ Abbiamo messo a punto un sistema di riscontro costante con la clientela, in modo da poter essere sempre perfettamente informati sulle esigenze attuali e future del cliente.
- ◆ Abbiamo migliorato la produttività del cliente riducendo della metà il tasso di guasti dei sistemi e velocizzando i tempi d'intervento della manutenzione.
- ◆ Abbiamo introdotto un costante miglioramento nella nostra struttura organizzativa in modo da poter conseguire in futuro livelli qualitativi ancor più elevati.
- ◆ Stiamo adeguando i nostri prodotti e servizi agli standard GLP per poter aiutare i clienti a soddisfare i requisiti di conformità posti loro dagli enti normativi.

Ma l'omologazione ISO 9001 non è tutto. Per quanto ci riguarda, la qualità viene definita dai nostri clienti: noi siamo soddisfatti solo se lo è il cliente. Ci adoperiamo al massimo per comprendere le esigenze del cliente, ricorrendo ad indagini di società private, gruppi di utenti, associazioni di consumatori e con il nostro programma di risposta Hallmark of Quality - il marchio di garanzia di qualità - oltre che col contatto diretto coi singoli clienti. I nostri prodotti ed i nostri processi sono configurati per rispondere a tali esigenze.

Sappiamo che a Voi i processi più avanzati e l'esperienza delle applicazioni di prim'ordine non bastano. Sappiamo che intendete unire le vostre forze con quelle d'un partner impegnato a fornire livelli qualitativi internazionali, affidabilità e valore, in modo tempestivo e costante.

Quel partner vogliamo essere noi.



Garanzia sugli strumenti analitici Varian, Inc.

Prodotti hardware

Tutti gli strumenti analitici commercializzati dalla Varian, Inc. sono garantiti da eventuali difetti di materiali e di costruzione per i periodi ed alle condizioni indicati sull'offerta Varian o comunque concordati per iscritto tra la Varian ed il Cliente. Il periodo di garanzia decorre dalla data di spedizione dalla Varian al Cliente. Se l'installazione è a carico del Cliente o compresa nel prezzo d'acquisto, il periodo di garanzia decorre dalla fine dell'installazione. Se il Cliente prevede di procedere all'installazione oltre i 30 giorni dalla consegna o se tale ritardo è imputabile alla mancata messa a disposizione, da parte del Cliente, di locali o strumenti idonei o al mancato rispetto delle ragionevoli istruzioni di preinstallazione della Varian o comunque a fatti imputabili al Cliente, il periodo di garanzia decorre dal 31° giorno dalla data di spedizione. Inoltre, la Varian addebiterà al Cliente le spese di manodopera e d'altro tipo sostenute per interventi d'installazione multipli o di verifica.

Prodotti software

Se il software viene fornito nell'ambito d'un contratto di licenza stipulato tra la Varian e il Cliente, trovano applicazione in via esclusiva le garanzie previste dal contratto.

In assenza d'un contratto di licenza e salvo diverso accordo scritto tra la Varian e il Cliente, vale il periodo di garanzia indicato nell'offerta della Varian. La Varian garantisce che i prodotti software, purché regolarmente utilizzati ed installati su hardware Varian o d'altre marche da essa indicate, hanno le prestazioni descritte nel Manuale d'uso fornito a corredo del software e che sono sostanzialmente esenti da difetti che impediscano l'esecuzione delle rispettive istruzioni di programma. La Varian non garantisce alcun funzionamento ininterrotto o senza errori.

Interventi Tecnici

Gli unici interventi previsti dalla garanzia sull'hardware sono o la riparazione dei malfunzionamenti dello strumento che, a giudizio della Varian, siano dovuti o riconducibili a difetti di costruzione dei materiali originali o, a discrezione della Varian, la sostituzione dei componenti difettosi, fermo restando che la Varian potrà, in alternativa, optare per il rimborso di una congrua parte del prezzo d'acquisto dello strumento o dell'accessorio difettosi.

La riparazione o la sostituzione in garanzia non valgono a prorogare in alcun modo il periodo di garanzia originariamente previsto.

Le riparazioni o le sostituzioni in garanzia verranno effettuate, ad esclusiva discrezione della Varian, inviando sul posto un tecnico o autorizzando la resa dello strumento o dell'accessorio difettoso alla Varian o al centro d'assistenza indicato dalla Varian. Il Cliente sarà responsabile di eventuali danni o perdite subiti durante il trasporto dallo strumento o dall'accessorio reso e dovrà pagare le spese di spedizione in via anticipata. La Varian restituirà al Cliente lo strumento o l'accessorio in porto franco con assicurazione a proprio carico. Sono a cura del Cliente gli eventuali reclami per perdite o danni di trasporto. Per eliminare eventuali anomalie di funzionamento del software, la Varian fornirà le eventuali revisioni del software disponibili qualora a suo giudizio siano il rimedio migliore.

Limitazioni della garanzia

La presente garanzia non copre il software fornito dal Cliente, le attrezzature e il software garantiti da altre case né la sostituzione del materiale di consumo o di durata limitata, quali, senza intento limitativo, filtri, provette, spie di stato dello strumento, voltmetri, setti, colonne, fusibili, carta ed inchiostro, nebulizzatori, celle a flusso, pistoni, guarnizioni, pezzi speciali, valvole, bruciatori, tubi di campionamento, inserti per sonde, testine di stampa, tubazioni rivestite in vetro, raccordi per tubi, dewars a temperatura variabile, linee di trasferimento, dischi flessibili, cassette a nastro magnetico, fotomoltiplicatori, filamenti, guarnizioni per vuoto, e tutte le parti esposte all'azione dei campioni o delle fasi mobili.

La presente garanzia decade in caso d'incidente, abuso, modifica, uso improprio, incuria, rottura, funzionamento o manutenzione impropri, modifiche non autorizzate od improprie o manomissioni, impiego in ambiente fisico non idoneo, impiego con alimentazione ai limiti o con altri mezzi o dispositivi inadeguati. Devono inoltre essere adottate tutte le misure ragionevoli atte ad evitare ogni e qualsiasi rischio.

La presente garanzia sostituisce ed esclude espressamente ogni altra garanzia espressa o implicita, comprese - senz'intento limitativo - le garanzie di commerciabilità ed idoneità a scopi, impieghi od applicazioni specifici nonché tutti gli altri obblighi o responsabilità della Varian, a meno che le altre garanzie, obblighi o responsabilità in parola non siano stati accettati per iscritto dalla Varian.

Limitazione degli interventi e delle responsabilità

Quelli qui contemplati sono gli unici ed esclusivi interventi cui ha diritto il Cliente. In nessun caso la Varian sarà responsabile per danni indiretti o consequenziali, mancata disponibilità, perdita di produzione o altre perdite subite.



VARIAN

Sistemas de calidad en Varian, Inc.

Las normas ISO 9000 fueron creadas en Ginebra en 1987 para acabar con una multitud de definiciones de calidad contradictorias. Estas normas constituyen un modelo de sistemas de garantía de calidad en el diseño, desarrollo, fabricación, instalación, mantenimiento y asistencia técnica de productos. Se han convertido en el banco de pruebas de garantía de calidad a nivel mundial y miden el grado de compromiso de una empresa con la calidad, así como el alcance de sus sistemas de calidad.

Diversas organizaciones mundiales, como la British Standards Institution (BSI), proporcionan expertos titulados de probada objetividad para investigar procedimientos de calidad, desarrollo de productos, procesos de fabricación y programas de servicio al cliente.

Varian, Inc., Analytical Instruments fue registrada en 1992 con la norma más exhaustiva de la serie ISO 9000: la ISO 9001. La certificación por la norma ISO 9001 significa que todas las etapas de nuestro sistema de calidad, como el desarrollo del producto, la fabricación, las pruebas finales, la expedición, así como los suministros y recambios, han sido examinados rigurosamente respecto a las normas más exigentes reconocidas internacionalmente. Significa que nos comprometemos a mantener un nivel de calidad con el que podrá siempre contar, hoy y en el futuro. Il nostro Sistema di Qualità ha ottenuto la certificazione ISO 9001 col numero FM21797.

Los sistemas de calidad que nos valieron la certificación ISO 9001 representan beneficios directos para nuestros clientes:

- ◆ haremos llegar nuestros aparatos más rápidamente que nunca. Podemos cumplir con pedidos urgentes aún más deprisa.
- ◆ Atenderemos sus pedidos de forma rápida y completa.
- ◆ Aplicamos un sistema de retorno de información permanente con nuestros clientes: siempre somos conscientes de sus necesidades, actuales o futuras.
- ◆ Hemos mejorado la productividad de nuestros clientes, disminuyendo el índice de defectos a la mitad y acortando el tiempo de respuesta del servicio de mantenimiento.
- ◆ Hemos integrado sistemas de mejora continuada en nuestra organización, de forma que podremos obtener niveles de calidad aún superiores en un futuro.
- ◆ Estamos integrando los requerimientos GLP en nuestros productos y servicios para ayudarle a cumplir con requerimientos de conformidad obligatorios.

La conformidad con ISO 9001 no nos basta. Para nosotros, los criterios de calidad los definen nuestros clientes. No estaremos satisfechos hasta que usted lo esté. Intentamos comprender las necesidades de nuestros clientes, a través de entidades independientes, grupos de usuarios, oficinas de asesoramiento a usuarios y nuestro programa de respuesta "Hallmark of Quality", además de los contactos directos con nuestros clientes. Nuestros productos y procedimientos están diseñados para poder corresponder a sus necesidades.

Sabemos que nuestros clientes buscan más que experiencia en procesos avanzados y aplicaciones punteras. Se trata de unir fuerzas con un socio que se compromete a entregar calidad reconocida a nivel mundial, fiabilidad y valor, a tiempo, siempre.

Nuestra meta principal es ser ese socio.



Instrumentos analíticos Varian, Inc. Garantía

Productos hardware

Todos los instrumentos analíticos vendidos por Varian, Inc. están garantizados contra defectos de materiales y de fabricación por la duración especificada y de acuerdo con los términos establecidos en las ofertas de Varian, o según lo especificado en el acuerdo escrito entre Varian y el cliente. El plazo de garantía comienza a partir de la fecha de **envío** del material de Varian al cliente original. Sin embargo, si la instalación ha sido pagada por el cliente o incluida en el precio de compra, el plazo de garantía comenzará a partir de la fecha de conclusión de la instalación. Si el cliente especifica que la **instalación** comenzará 30 días después de la entrega, o si este plazo se genera por la imposibilidad por parte del cliente de proveer los medios necesarios o la falta de cumplimiento de las directrices de preinstalación de Varian, o cualquier otra omisión por parte del cliente, el plazo de garantía comenzará el trigésimoprimer día a partir del envío. Además, Varian cobrará al cliente por trabajos y otros gastos relacionados con intervenciones de servicio de instalación múltiples o tardías.

Productos de software

Cuando el software se suministra dentro del marco de una licencia de utilización acordada entre Varian y el cliente, cualquier garantía estará estrictamente limitada a los términos del citado acuerdo. En ausencia de una licencia de utilización y a no ser que exista un acuerdo de período de garantía por escrito entre Varian y el cliente, el período de garantía será el fijado de acuerdo con los términos de Varian que se citan. Varian garantiza estos productos de software si se instalan y usan con hardware Varian, u otro tipo de hardware en el que Varian certifique que funcionan según lo descrito en Manual de instrucciones, y que esté libre de defectos que impidan la ejecución de instrucciones de programación. Sin embargo, Varian no garantiza la utilización ininterrumpida o libre de errores.

Recursos

El único y exclusivo recurso en cuanto a hardware bajo garantía será **reparar** los defectos del aparato, que, en opinión de Varian, sean claramente imputables a defectos de los materiales originales o de fabricación, o **sustituir** los componentes defectuosos, pudiendo Varian optar por **reembolsar** una parte equitativa del precio de compra del aparato o componente.

Las reparaciones o sustituciones en período de garantía no prolongan el período de garantía original.

Las reparaciones o sustituciones en período de garantía se efectuarán, a criterio exclusivo de Varian, enviando un representante de servicio posventa a la instalación, o autorizando al cliente a reexpedir el componente o aparato defectuoso a Varian o a un servicio de reparación designado. El cliente será responsable sobre pérdidas o daños de transporte, y pagará los costes de dicho transporte. Varian reexpedirá el componente o aparato a portes pagados y con seguro de transporte. Las demandas por daños o pérdidas deberán ser gestionadas por el cliente. Para corregir anomalías de funcionamiento de software, Varian editará revisiones de software, siempre y cuando éstas estén disponibles, y cuando, en opinión de Varian, este sea el remedio más eficaz.

Limitación de garantía

Esta garantía no cubre software provisto por el cliente, equipos y software garantizados por otros fabricantes, consumibles o artículos de duración de vida limitada, como son, entre otros: filtros, elementos de vidrio, pilotos, lámparas, diafragmas, columnas, fusibles, papel y tinta de gráficos, nebulizadores, células de flujo, pistones, cierres, juntas, válvulas, quemadores, tubos de muestras, inserciones de sondas, cabezales de impresión, tubos de vidrio, juntas de tubo, dispositivos de temperatura variable, líneas de transferencia, disquetes, cintas magnéticas, multiplicadores de electrones, filamentos, juntas de vacío, soportes y todos los componentes en contacto con muestras y partes móviles.

Esta garantía no tendrá efecto en los casos de accidente, abuso, alteración, utilización incorrecta, negligencia, rotura, mantenimiento o uso inadecuados, modificaciones inadecuadas o no autorizadas, uso de la fuerza, uso en un entorno inadecuado, funcionamiento con una alimentación defectuosa o el uso con medios inadecuados. Es necesario tomar las precauciones adecuadas para evitar riesgos.

Las garantías de los productos de software de Varian sustituyen y excluyen cualquier otra garantía, implícita o explícita, incluidas pero sin limitación, las garantías de comerciabilidad, adecuación a un fin, uso o aplicación en particular, y todas las demás obligaciones y responsabilidades por parte de Varian, a no ser que estas garantías, obligaciones y responsabilidades sean otorgadas expresamente y por escrito por Varian.

Limitaciones de recursos y responsabilidades

Los recursos provistos en lo citado son única y exclusivamente los del cliente. Varian no podrá ser responsable en ningún caso por daños imprevistos o consecuencias, pérdida de uso, pérdida de producción o cualquier otra pérdida incurrida.

Safety Information

Operating Instructions

This instruction manual is provided to help you establish operating conditions which will permit safe and efficient use of your equipment. Special considerations and precautions are also described in the manual, which appear in the form of **NOTES**, **CAUTIONS**, and **WARNINGS** as described below. It is important that you operate your equipment in accordance with this instruction manual and any additional information which may be provided by Varian. Address any questions regarding the safe and proper use of your equipment to your local Varian office.

NOTE

Information to aid you in obtaining optimal performance from your instrument.



CAUTION

Alerts you to situations that may cause moderate injury and/or equipment damage, and how to avoid these situations.



WARNING

Alerts you to potentially hazardous situations that could result in serious injury, and how to avoid these situations.

Warning Symbol



**WARNING:
SHOCK HAZARD**



**WARNING:
CHEMICAL HAZARD**



**WARNING:
BURN HAZARD**



**WARNING:
EYE HAZARD**



**WARNING:
FIRE HAZARD**



**WARNING:
EXPLOSION HAZARD**



**WARNING:
RADIATION SOURCE**



**WARNING:
MOVING PARTS**

Warning Description

Hazardous voltages are present inside instrument. Disconnect from main power before removing screw-attached panels.

Hazardous chemicals may be present. Avoid contact, especially when replenishing reservoirs. Use proper eye and skin protection.

Very hot or cryogenically cold surfaces may be exposed. Use proper skin protection.

Eye damage could occur either from flying particles, chemicals, or UV radiation. Use proper eye and face protection.

The potential for fire may be present. Follow manual instructions for safe operation.

The potential for explosion may exist because of type of gas or liquid used.

Ionizing radiation source is present. Follow manual instructions for safe operation.

Keep hands and fingers away.



VARIAN

General Safety Precautions

Follow these safety practices to ensure safe equipment operation.

- Perform periodic leak checks on all supply lines and pneumatic plumbing.
- Do not allow gas lines to become kinked or punctured. Place lines away from foot traffic and extreme heat or cold.
- Store organic solvents in fireproof, vented and clearly labeled cabinets so they are easily identified as toxic and/or flammable materials.
- Do not accumulate waste solvents. Dispose of such materials through a regulated disposal program and not through municipal sewage lines.

NOTICE: This instrument has been tested per applicable requirements of EMC Directive as required to carry the European Union CE Mark. As such, this equipment may be susceptible to radiation/interference levels or frequencies which are not within the tested limits.



WARNING

This instrument is designed for chromatographic analysis of appropriately prepared samples. It must be operated using appropriate gases and/or solvents and within specified maximum ranges for pressure, flows, and temperatures as described in this manual. If the equipment is used in a manner not specified by the manufacturer, the protection provided by the equipment may be impaired.



WARNING

It is the responsibility of the Customer to inform Varian Customer Support Representatives if the instrument has been used for the analysis of hazardous biological, radioactive, or toxic samples, prior to any instrument service being performed or when an instrument is being returned to the Service Center for repair.

Electrical Hazards

- Disconnect the instrument from all power sources before removing protective panels to avoid exposure to potentially dangerous voltages.
- When it is necessary to use a non-original power cord plug, make sure the replacement cord adheres to the color coding and polarity described in the manual and all local building safety codes.
- Replace blown fuses with fuses of the size and rating stipulated on the fuse panel or in the manual.
- Replace faulty or frayed power cords immediately with the same type and rating.
- Make sure that voltage sources and line voltage match the value for which the instrument is wired.

Compressed Gas Cylinders

- Store and handle compressed gases carefully and in strict adherence to safety codes.
- Secure cylinders to an immovable structure or wall.
- Store and move cylinders in an upright, vertical position. Before transport, remove regulators and install cylinder cap.
- Store cylinders in a well-ventilated area away from heat, direct sunshine, freezing temperatures, and ignition sources.
- Mark cylinders clearly so there is no doubt as to their contents.
- Use only approved regulators and connections.
- Use only connector tubing that is chromatographically clean (Varian Part Number 03-918326-00) and has a pressure rating significantly greater than the highest outlet pressure from the regulator.

GC Safety Practices

Exhaust System

No special exhaust ducting is necessary for GC detectors installed in a well-ventilated room except when the detectors are used to test hazardous chemicals. If you do install ducting:

- Use only fireproof ducting.
- Install a blower at the duct outlet.
- Locate duct intakes such that their vibration or air movement does not effect detector operation.
- Check periodically for proper operation of the duct.
- Ensure proper ventilation in lab area.

Radioactive Source Detectors

- Read carefully and comply with all NOTES, CAUTIONS, and WARNINGS in the Ni⁶³ ECD manual.
- Perform the tests for removable radioactive contamination described in the Ni⁶³ ECD manual.
- Comply with leak test schedules and procedures.

Burn Hazard

Heated or cryogenically cooled zones of gas chromatographs can remain hot or cold for a considerable time after instrument power is turned off. To prevent painful burns, ensure that all heated or cooled areas have returned to room temperature or wear adequate hand protection before you touch potentially hot or cold surfaces.

LC Safety Practices

High Pressure Hazard

- If a line ruptures, a relief device opens, or a valve opens accidentally under pressure, potentially hazardous high liquid pressures can be generated by the pump causing a high velocity stream of volatile and/or toxic liquids.
- Wear face protection when you inject samples or perform routine maintenance.
- Never open a solvent line or valve under pressure. Stop the pump first and let the pressure drop to zero.
- Use shatter-proof reservoirs capable of operating at 50-60 psi.
- Keep the reservoir enclosure closed when the reservoir is under pressure.
- Read and adhere to all NOTES, CAUTIONS, and WARNINGS in the manual.

Flash Chromatography

The operator should be familiar with the physico-chemical properties of the components of the mobile phase.

Keep solvents from direct contact with the polyurethane supply tubing as certain solvents will cause weakening and leaks with possible bursting.

All components of the system should be connected to a common power supply and common ground. This ground must be a true ground rather than a floating ground.

Non-polar solvents can develop a static charge when pumped through the system. All vessels that contain mobile phase (including tubing and collection vessels) must be grounded to dissipate static electricity.

Employ static measuring and static discharge devices (e.g., air ionizers) to safeguard against the buildup of static electricity.

Ultraviolet Radiation

Liquid chromatograph detectors that use an ultraviolet light source have shielding to prevent radiation exposure to personnel.

For continued protection:

- Ensure that protective lamp covers of variable and fixed wavelength detectors are in place during operation.
- Do not look directly into detector fluid cells or at the UV light source. When inspecting the light source or fluid cell, always use protective eye covering such as borosilicate glass or polystyrene.

The following is a Federal Communications Commission advisory: This equipment has been tested and found to comply with the limits of a Class A computing device, pursuant to part 15 of the FCC Rules. These limits are designed to provide reasonable protection against harmful interference when the equipment is operated in a commercial environment. This equipment generates, uses, and can radiate radio frequency energy and, if not installed and used in accordance with the instruction manual, may cause harmful interference to radio communications. Operation of this equipment in a residential area is likely to cause harmful interference in which case the user will be required to correct the interference at his own expense.

Spare Parts Availability

It is the policy of Varian to provide operational spare parts for any instrument and major accessory for a period of five (5) years after shipment of the final production run of that instrument. Spare parts will be available after this five (5) year period but on an *as available* basis. Operational spare parts are defined as those individual electrical or mechanical parts that are susceptible to failure during their normal operation. Examples include relays, lamps, temperature probes, detector elements, motors, etc. Sheet metal parts, structural members or assemblies and castings, printed circuit boards, and functional modules are normally capable of being rebuilt to like-new condition throughout their useful life and therefore will be supplied only on an *as available* basis after the final production run of the instrument.

Service Availability

Varian provides a variety of services to support its customers after warranty expiration. Repair service can be provided by attractively priced service contracts or on a time and material basis. Technical support and training can be provided by qualified personnel on both a contractual or as-needed basis.

Varian, Inc. Analytical Instruments Sales Offices

For Sales or Service assistance and to order Parts and Supplies, contact your local Varian office.

Argentina

Buenos Aires
Tel. +54.11.4.783.5306

Australia

Mulgrave, Victoria
Tel. +61.3.9566.1134

Austria

Vösendorf bei Wien
Tel. +43.1.699.9669

Benelux

Bergen Op Zoom
Tel. +31.164.282.800

Brazil and Latin America (S)

São Paulo
Tel. +55.11.820.0444

Canada

Mississauga, Ontario
Tel. 800.387.2216

China

Beijing
Tel. +86.106209.1727

Europe

Middelburg, The Netherlands
Tel. +31.118.671.000

France

Les Ulis Cédex
Tel. +33.1.6986.3838

Germany

Darmstadt
Tel. +49.6151.7030

India

Mumbai
Tel. +91.22.857.0787/88/89

Italy

Torino
Tel. +39.011.997.9111

Japan

Tokyo
Tel. +81.3.5232.1211

Korea

Seoul
Tel. +82.2.345.22452

Mexico and Latin America (N)

Mexico City
Tel. +52.5.523.9465

Russian Federation

Moscow
Tel. +7.095.937.4280

Spain

Madrid
Tel. +34.91.472.7612

Sweden

Solna
Tel. +46.8.445.1620

Switzerland

Varian AG
Tel. +41.848.803.800

Taiwan

Taipei Hsien
Tel. +886.2.698.9555

United Kingdom and Ireland

Walton-on-Thames
Tel. +44.1932.898000

Venezuela

Valencia
Tel. +58.41.257.608

United States

Walnut Creek, California, USA
Tel. +1.800.926.3000
(GC and GC/MS)
Tel. +1.800.367.4752
(LC)



VARIAN

www.varianinc.com

Sicherheitsinformationen

Arbeitsanleitungen

Diese Arbeitsanleitung will Ihnen bei der Aufstellung solcher Arbeitsbedingungen helfen, die einen sicheren und wirkungsvollen Gebrauch Ihrer Geräte ermöglichen. Besondere Überlegungen und Vorsichtsmaßnahmen erscheinen in diesem Handbuch in Form von **HINWEIS**, **ACHTUNG** und **WARNUNG**, wie unten beschrieben. Es ist wichtig, daß Sie Ihr Gerät in Übereinstimmung mit dieser Arbeitsanleitung und allen möglichen zusätzlichen Informationen von Varian betreiben. Alle Fragen bezüglich Sicherheit und Handhabung Ihres Gerätes richten Sie an Ihr Varian Büro.

HINWEIS

Eine Information, um einen optimalen Wirkungsgrad Ihres Instruments zu erzielen.



Weist auf Situationen, die zu mäßiger Beeinträchtigung und/oder zu Geräteschäden führen und auf die Vermeidung dieser Situationen hin.



Weist auf mögliche Gefahrensituationen, die zu ernsthaften Verletzungen führen können und auf die Vermeidung dieser Situationen hin.

Warnungssymbol



**WARNUNG
ELEKTRISCHER
SCHLAG**

Warnungsbeschreibung

Gefährliche Spannungen bestehen innerhalb des Instruments. Trennen Sie das Gerät vom Netz, bevor Sie abschraubbare Paneele entfernen.



**WARNUNG
CHEMISCHE GEFAHR**

Gefährliche Chemikalien können vorhanden sein. Vermeiden Sie jeden Kontakt, besonders beim Auffüllen der Reservoirs. Benutzen Sie wirksamen Augen und Hautschutz.



**WARNUNG
VERBRENNUNGSGEFAHR**

Sehr heiße oder tiefstgeköhlte Oberflächen können freigelegt sein. Benutzen Sie einen wirksamen Hautschutz.



**WARNUNG
AUGENVERLETZUNG**

Herumfliegende Partikel, Chemikalien oder UV-Strahlung können Augenschäden verursachen. Tragen Sie deshalb einen geeigneten Schutz für Augen und Gesicht.



**WARNUNG
FEUERGEFAHR**

Es besteht eine mögliche Feuergefahr. Beachten Sie die Vorschriften im Handbuch für eine gefahrlose Benutzung.



**WARNUNG
EXPLOSIONSGEFAHR**

Eine mögliche Explosionsgefahr besteht infolge der benutzten Gas- oder Flüssigkeitsart.



**WARNUNG
STRAHLUNGSQUELLE**

Es besteht eine ionisierende Strahlungsquelle. Beachten Sie die Vorschriften im Handbuch für eine gefahrlose Benutzung.



**WARNUNG
BEWEGTE TEILE**

Bleiben Sie mit Ihren Händen und Fingern weg.



VARIAN

Allgemeine Sicherheitsmaßnahmen

Befolgen Sie diese Sicherheitspraktiken für eine gefahrlose Gerätebenutzung.

- Prüfen Sie regelmäßig alle Versorgungs und Pneumatikleitungen auf Lecks.
- Gasleitungen dürfen nicht geknickt oder angestochen werden. Verlegen Sie die Leitungen außerhalb von Laufwegen und abseits von extremer Hitze oder Kälte.
- Lagern Sie organische Lösungsmittel in feuerfesten, belüfteten und eindeutig bezeichneten Schränken, damit sie leicht als toxische und/oder brennbare Materialien erkannt werden.
- Sammeln Sie keine Lösungsmittelabfälle. Entsorgen Sie solche Materialien über ein geregeltes Entsorgungsprogramm und nicht über die öffentlichen Abwasserleitungen.

HINWEIS: Dies Instrument wurde nach den zutreffenden Vorschriften der EMC Direktive getestet, die zum Führen des CE Zeichens der Europäischen Union berechtigen. Dieses Gerät kann an sich auf Strahlungs-/Störpegel oder Frequenzen außerhalb der getesteten Grenzen reagieren.



WARNUNG

Dies Instrument ist für chromatographische Analysen entsprechend präparierter Proben gedacht. Es muß mit geeigneten Gasen und/oder Lösungsmitteln und innerhalb der im Handbuch spezifizierten maximalen Werte für Druck, Flüsse und Temperaturen betrieben werden.



WARNUNG

Der Kunde ist vor der Durchführung irgendeines Geräteservices verpflichtet den Varian Kundendienstvertreter zu informieren, wenn das Instrument für Analysen gefährlicher biologischer, radioaktiver oder toxischer Proben benutzt worden ist.

Elektrische Gefahren

- Lösen Sie das Instrument von allen Stromquellen, bevor Sie Schutzpaneele entfernen, damit Sie nicht mit potentiell gefährlichen Spannungen in Berührung kommen.
- Wenn ein Nicht-Original Netzkabelstecker benutzt werden muß, muß das Austausch kabel die im Handbuch beschriebene Farbcodierung und Polarität beibehalten und alle örtlichen Sicherheitsvorschriften erfüllen.
- Ersetzen Sie durchgebrannte Sicherungen nur mit Sicherungen der Werte, die am Sicherungspaneel oder im Handbuch angegeben sind.
- Ersetzen Sie fehlerhafte oder durchgescheuerte Netzkabel sofort durch Kabel gleicher Art.
- Sorgen Sie dafür, daß Spannungsquellen und die Netzspannung den gleichen Wert haben, für den das Instrument verdrahtet ist.

Gasdruckflaschen

- Lagern und handhaben Sie komprimierte Gase vorsichtig und in strikter Einhaltung der Sicherheitsvorschriften.
- Befestigen Sie die Gasflaschen an feststehenden Aufbauten oder an Wänden.
- Lagern und transportieren Sie Gasflaschen in aufrechter Stellung. Druckregler zuvor abnehmen.
- Lagern Sie Gasflaschen in gut durchlüfteten Räumen, weit genug weg von Heizungen, direktem Sonnenschein, Frosttemperaturen und Entzündungszonen.
- Kennzeichnen Sie die Flaschen so eindeutig, daß kein Zweifel über deren Inhalt bestehen kann.
- Benutzen Sie nur geprüfte Druckminderer und Verbindungsstücke.
- Benutzen Sie nur chromatographisch reines Verbindungsrohr (Varian Part Number 03-918326-00), das wesentlich höheren Druck als den höchsten Ausgangsdruck des Druckminderers aushält.

GC Sicherheitspraktiken

Abgassystem

Für GC Detektoren, die in einem gut durchlüfteten Raum installiert sind, ist keine spezielle Abgasführung erforderlich, außer wenn die Detektoren zum Testen gefährlicher Chemikalien benutzt werden. Wenn Sie eine Abgasführung installieren:

- Benutzen Sie nur feuerfeste Führungen.
- Installieren Sie ein Gebläse am Ausgang.
- Ordnen Sie die Ansaugöffnung so an, daß ihre Erschütterungen oder Luftströmungen nicht die Detektorfunktion beeinträchtigen.
- Prüfen Sie regelmäßig die einwandfreie Arbeitsweise der Abgasführung.
- Sorgen Sie für gute Entlüftung im Laborbereich.

Radioaktive Detektoren

- Lesen Sie sorgfältig und befolgen Sie alle **HINWEISE, ACHTUNGEN** und **WARNUNGEN** im Ni⁶³ ECD Handbuch.
- Führen Sie die Tests für zu beseitigende radioaktive Kontamination durch, die im Ni⁶³ ECD Handbuch beschrieben sind.
- Erfüllen Sie die Zeitpläne und Verfahren zur Dichtigkeitsprüfung.

Verbrennungsgefahr

Beheizte oder tieftemperaturgekühlte Zonen des Gaschromatographen können beträchtlich lange heiß oder kalt bleiben, nachdem das Instrument bereits abgeschaltet ist. Zur Vermeidung schmerzhafter Verbrennungen müssen Sie darauf achten, daß alle beheizten oder gekühlten Zonen auf Raumtemperatur zurückgegangen sind oder Sie müssen ausreichenden Handschutz benutzen, bevor Sie möglicherweise heiße oder kalte Oberflächen berühren.

LC Sicherheitspraktiken

Gefahr durch hohen Druck

Wenn eine Leitung bricht, eine Entlüftungseinheit sich öffnet oder ein Ventil sich unbeabsichtigt unter Druck öffnet, kann durch die Pumpe möglicherweise ein gefährlich hoher Flüssigkeitsdruck entstehen, der einen Strahl flüchtiger und/oder toxischer Flüssigkeiten von hoher Stömungsgeschwindigkeit verursacht.

- Tragen Sie einen Gesichtsschutz, wenn Sie Proben injizieren oder Routinewartungen durchführen.

- Öffnen Sie niemals eine unter Druck stehende Lösungsmittelleitung oder ein Ventil. Halten Sie zuerst die Pumpe an und lassen Sie den Druck auf Null abfallen.
- Benutzen Sie splittersichere Reservoirs, die für einen Druck von 3,4 bis 4,1 bar ausgelegt sind.
- Halten Sie die Reservoirverkleidung geschlossen, wenn die Reservoirs unter Druck stehen.
- Lesen Sie und befolgen Sie alle **HINWEISE, ACHTUNGEN** und **WARNUNGEN** im Handbuch.

Blitzlicht-Chromatographie

Der Bediener sollte mit den physikalisch-chemischen Eigenschaften der Komponenten vertraut sein, aus denen sich die mobile Phase zusammensetzt.

Vermeiden Sie direkten Kontakt der Lösungsmittel mit den Zuführungsleitungen aus Polyurethan, da einige Lösungsmittel das Material der Leitungen schwächen und damit Undichtigkeiten oder Brüche hervorrufen können.

Alle Systemkomponenten sollten an der gleichen Netzstromquelle und einer gemeinsamen Erdung angeschlossen sein. Dabei muss es sich um eine echte, nicht um eine schwebende Erdung handeln.

Nicht-polare Lösungsmittel können sich beim Pumpen durch das System statisch aufladen. Alle Gefäße, die mobile Phase enthalten (einschließlich Leitungen und Sammelgefäße), müssen zur Ableitung elektrostatischer Aufladungen geerdet sein.

Setzen Sie Geräte zur Messung und Ableitung elektrostatischer Aufladungen (z.B. Geräte zur Luftionisierung) als Maßnahmen gegen den Aufbau statischer Elektrizität ein.

Ultraviolette Strahlung

Detektoren in Liquidchromatographen, die eine ultraviolette Lichtquelle benutzen, besitzen eine Abschirmung, die das Bedienungspersonal gegen Abstrahlungen schützt. Zum ständigen Schutz:

- Achten Sie darauf, daß die schützende Lampenabdeckung der Detektoren mit variablen und festen Wellenlängen während des Betriebs an ihrem Platz ist.
- Schauen Sie nicht direkt in die Flüssigkeitszellen im Detektor oder in die UV Lampe. Zum Inspizieren der Lichtquelle oder der Flüssigkeitszelle benutzen Sie immer einen wirksamen Augenschutz, wie er durch Borsilikatglas oder Polystyrol gewährleistet wird.

Verfügbarkeit von Ersatzteilen

Es ist Varian's Grundsatz, Ersatzteile für alle Instrumente und die wichtigsten Zubehöre für einen Zeitraum von fünf (5) Jahren nach dem Fertigungsauslauf dieser Geräteserie verfügbar zu haben. Nach diesem Zeitraum von fünf (5) Jahren können Ersatzteile auf der Basis *solange vorhanden* bezogen werden. Als Ersatzteil werden hier solche elektrischen und mechanischen Einzelteile verstanden, die unter normalen Bedingungen ausfallen können. Beispiele sind Relais, Lampen, Temperaturfühler, Detektorelemente, Motore usw. Metallbleche, Formteile oder Baugruppen und Gußteile, PC Boards und Funktionsmodule können normalerweise neuwertähnlich für eine brauchbare Lebensdauer instandgesetzt werden und werden deshalb nur auf der Basis *solange vorhanden* nach dem Produktionsauslauf des Instruments geliefert werden.

Serviceverfügbarkeit

Varian bietet seinen Kunden auch nach dem Auslaufen der Garantie eine Vielfalt von Serviceleistungen an. Reparaturservice kann zu attraktiven Preisen über eine Wartungsvereinbarung oder nach Zeit- und Materialaufwand zur Verfügung gestellt werden. Technische Unterstützung und Training bieten wir Ihnen durch qualifizierte Chemiker sowohl auf einer Kontraktbasis als auch nach Ihren Erfordernissen an.

Varian Analytical Instruments Verkaufsbüros

Für Verkaufs oder Servicehilfe und zum Bestellen von Teilen und Zubehören setzen Sie sich bitte mit Ihrem Varian Büro in Verbindung.

Argentina

Buenos Aires
Tel. +54.11.4.783.5306

Australia

Mulgrave, Victoria
Tel. +61.3.9566.1134

Austria

Vösendorf bei Wien
Tel. +43.1.699.9669

Benelux

Bergen Op Zoom
Tel. +31.164.282.800

Brazil and Latin America (S)

São Paulo
Tel. +55.11.820.0444

Canada

Mississauga, Ontario
Tel. 800.387.2216

China

Beijing
Tel. +86.106209.1727

Europe

Middelburg, The Netherlands
Tel. +31.118.671.000

France

Les Ulis Cédex
Tel. +33.1.6986.3838

Germany

Darmstadt
Tel. +49.6151.7030

India

Mumbai
Tel. +91.22.857.0787/88/89

Italy

Torino
Tel. +39.011.997.9111

Japan

Tokyo
Tel. +81.3.5232.1211

Korea

Seoul
Tel. +82.2.345.22452

Mexico and Latin America (N)

Mexico City
Tel. +52.5.523.9465

Russian Federation

Moscow
Tel. +7.095.937.4280

Spain

Madrid
Tel. +34.91.472.7612

Sweden

Solna
Tel. +46.8.445.1620

Switzerland

Varian AG
Tel. +41.848.803.800

Taiwan

Taipei Hsien
Tel. +886.2.698.9555

United Kingdom and Ireland

Walton-on-Thames
Tel. +44.1932.898000

Venezuela

Valencia
Tel. +58.41.257.608

United States

Walnut Creek, California, USA
Tel. +1.800.926.3000
(GC and GC/MS)
Tel. +1.800.367.4752
(LC)



VARIAN

www.varianinc.com

Informations et mesures de sécurité

Instructions de fonctionnement

Ce manuel d'instruction est conçu pour aider l'utilisateur à créer des conditions opératoires lui permettant de faire fonctionner le matériel efficacement et en toute sécurité. Il contient entre autres certaines observations spéciales présentées sous forme de **NOTES**, **MISES EN GARDE** et **AVERTISSEMENTS**. Il est important de faire fonctionner ce matériel conformément aux instructions du présent manuel et à toute autre information émanant de Varian. S'adresser au bureau régional Varian pour toute question relative à la sécurité ou à l'utilisation correcte du matériel.

NOTE

Information destinée à tirer le meilleur parti du matériel sur le plan des performances











MISE EN GARDE

Attire l'attention sur une situation pouvant occasionner des dommages corporels légers et/ou des dégâts mineurs à l'appareil et indique comment remédier à cette situation



AVERTISSEMENT

Attire l'attention sur une situation potentiellement dangereuse pouvant occasionner des dommages corporels importants et indique comment remédier à cette situation

Symboles d'avertissement	Description
 ATTENTION RISQUE D'ELECTROCUTION	Exposition à des tensions dangereuses. Débrancher le matériel du secteur avant de dévisser les panneaux protecteurs.
 ATTENTION SUBSTANCES CHIMIQUES DANGER	Présence éventuelle de substances chimiques dangereuses. Eviter tout contact, en particulier lors du remplissage des réservoirs. Prendre les mesures de protection adéquates pour les yeux et la peau.
 ATTENTION RISQUE DE BRÛLURES	Exposition à des surfaces chaudes ou traitées cryogéniquement. Prendre les mesures de protection adéquates pour la peau.
 ATTENTION DANGER POUR LES YEUX	Les dommages causées aux yeux sont de deux natures différentes : jet de particules et de produits chimiques ou radiations UV. Utiliser des protections du visage et des yeux appropriées.
 ATTENTION RISQUE D'INCENDIE	Risque potentiel d'incendie. Se conformer aux instructions du manuel pour faire fonctionner le matériel en toute sécurité.
 ATTENTION RISQUE D'EXPLOSION	Risque potentiel d'explosion en raison du type de gaz ou de liquide utilisé.
 ATTENTION SOURCE DE RADIATION	Présence d'une source de radiation ionisante. Se conformer aux instructions du manuel pour faire fonctionner le matériel en toute sécurité.
 ATTENTION PIECES EN MOUVEMENT	Garder les mains et les doigts hors de portée.



Précautions générales en matière de sécurité

Les pratiques suivantes garantissent une utilisation sans risques du matériel:

- Effectuer régulièrement des essais d'étanchéité de tous les conduits d'alimentation et de tous les tuyaux du système pneumatique.
- Ne pas travailler avec des conduits de gaz déformés ou percés. Installer les conduits de gaz à l'écart des allées et venues et à l'abri du chaud ou du froid.
- Conserver les solvants organiques dans des récipients à l'épreuve du feu, bien ventilés et portant mention de la nature de leur contenu, en particulier lorsque lesdits solvants sont toxiques et/ou inflammables.
- Ne pas accumuler les solvants de rebut. Les éliminer conformément à un programme agréé d'élimination des déchets et non via les égouts municipaux.

NOTE: Ce matériel a été testé conformément aux dispositions de la directive CME afin de pouvoir porter le sigle CE de l'Union européenne. Il en résulte qu'il peut être sensible à des niveaux de radiation/d'interférence ou à des fréquences se situant hors des limites testées.



ATTENTION

Ce matériel est conçu pour effectuer des analyses chromatographiques d'échantillons préparés selon des méthodes appropriées. Il convient de le faire fonctionner avec les gaz et/ou les solvants adéquats et dans les limites des pressions, des débits et des températures maximales spécifiées dans le présent manuel.



ATTENTION

Le client est tenu d'informer le service Varian d'assistance à la clientèle que son matériel a été utilisé pour l'analyse d'échantillons biologiques dangereux, radioactifs ou toxiques avant que n'en soit effectué la maintenance.

Risques de chocs électriques

- Déconnecter le matériel de toute source d'alimentation avant d'en démonter les panneaux de protection, sous peine de s'exposer à des tensions dangereuses.
- En cas d'utilisation d'un cordon d'alimentation n'étant pas d'origine, s'assurer que celui-ci soit conforme à la polarité et au codage des couleurs décrits dans le manuel d'utilisation ainsi qu'à toutes les normes régionales de sécurité régissant le secteur de la construction.
- Remplacer les fusibles sautés par des fusibles de même type que ceux stipulés sur le panneau des fusibles ou dans le manuel d'utilisation.
- Remplacer les cordons d'alimentation défectueux ou dénudés par des cordons d'alimentation de même type.
- S'assurer que les sources de tension et la tension de secteur correspondent à la tension de fonctionnement du matériel.

Bouteilles à gaz comprimé

- Ranger et manipuler les bouteilles à gaz comprimé avec précaution et conformément aux normes de sécurité.
- Fixer les bouteilles à gaz comprimé à un mur ou à une structure inamovible.
- Ranger et déplacer les bouteilles à gaz comprimé en position verticale. Avant de transporter les bouteilles à gaz comprimé, retirer leur régulateur.
- Ranger les bouteilles dans un endroit bien ventilé et à l'abri de la chaleur, des rayons directs du soleil, du gel ou des sources d'allumage.
- Marquer les bouteilles de manière à n'avoir aucun doute quant à leur contenu.
- N'utiliser que des connexions et régulateurs agréés.
- N'utiliser que des tuyaux de raccordement propres sur le plan chromatographique (Varian P/N 03-918326-00) et pouvant supporter des pressions sensiblement plus élevées que la plus haute pression de sortie du régulateur.

Mesures de sécurité en CPG

Systeme d'échappement

Les détecteurs CPG installés dans une pièce bien ventilée ne nécessitent pas de conduits spéciaux d'échappement excepté lorsqu'ils sont destinés à analyser des substances chimiques dangereuses. Lors de l'installation de tels conduits:

- N'utiliser que des conduits à l'épreuve du feu
- Installer un ventilateur à la sortie du conduit.
- Placer les orifices d'aspiration de manière à ce que les vibrations ou les mouvements d'air n'affectent pas le fonctionnement du détecteur.
- Vérifier périodiquement l'état du conduit.
- S'assurer que le laboratoire est correctement ventilé.

Détecteurs à source radioactive

- Se conformer au manuel d'utilisation de l'ECD Ni⁶³, en particulier à ses **NOTES, MISES EN GARDE ET AVERTISSEMENTS**.
- Effectuer les tests de décontamination radioactive décrits dans le manuel d'utilisation de l'ECD Ni⁶³.
- Se conformer aux procédures et au calendrier des essais d'étanchéité.

Risque de brûlures

Les zones des chromatographes à gaz chauffées ou traitées cryogéniquement peuvent rester très chaudes ou très froides durant une période plus ou moins longue après la mise hors tension du matériel. Pour éviter les brûlures, s'assurer que ces zones sont revenues à température ambiante ou utiliser un dispositif adéquat de protection des mains avant de les toucher.

Mesures de sécurité en CPL

Risques liés aux hautes pressions

En cas de rupture d'un tuyau ou en cas d'ouverture accidentelle d'une vanne alors que le système est sous pression, la pompe peut occasionner des dommages en expulsant à grande vitesse des jets de liquides volatiles et/ou toxiques.

- Mettre un masque de protection lors de l'injection des échantillons ou en effectuant les opérations de maintenance de routine.

- Ne jamais déconnecter un conduit de solvant ou une vanne sous pression. Arrêter préalablement la pompe et laisser la pression descendre à zéro.
- Utiliser des réservoirs incassables à 50-60 psi.
- Laisser l'enceinte du réservoir fermée lorsque le réservoir est sous pression.
- Se conformer aux **NOTES, MISES EN GARDE ET AVERTISSEMENTS** du manuel d'utilisation.

Chromatographie Flash

L'utilisateur aura la connaissance des propriétés physico-chimiques des constituants de la phase mobile.

Eviter le contact direct des solvants avec les tuyaux en polyuréthane : certains solvants sont susceptibles de provoquer des faiblesses et des fuites avec risques d'explosion.

Tous les constituants du système devront être connectés à une source de courant commune et à une prise de terre commune. Cette prise de terre devra être fixe et non mobile.

Les solvants non-polaires peuvent produire de l'électricité statique lorsqu'ils passent au travers du système. Les bouteilles qui contiennent la phase mobile (incluant les tuyaux et les flacons de collecte de fractions) doivent être mises à la terre pour éliminer l'électricité statique.

Utiliser des appareils de mesure et de décharge d'électricité statique (par exemple des ionisateurs d'air) pour combattre la formation d'électricité statique.

Radiations ultraviolettes

Les détecteurs CPL utilisant une source lumineuse ultraviolette comportent un écran destiné à se prémunir contre les expositions aux rayonnements.

Pour s'assurer une protection permanente:

- Vérifier que le couvercle de protection de la lampe des détecteurs opérant à des longueurs d'onde variables et fixes soit bien en place durant le fonctionnement du matériel.
- Ne pas regarder directement les cellules du détecteur ou la source d'UV. Se protéger systématiquement les yeux lors du contrôle de la source lumineuse ou des cellules, par exemple au moyen de verres borosilicatés ou en polystyrène.

Disponibilité des pièces de rechange

La politique de Varian consiste à fournir des pièces de rechange pour tous les appareils et accessoires majeurs durant une période de cinq (5) ans après livraison de leur production finale. Les pièces de rechange ne sont fournies au terme de cette période de cinq (5) ans que suivant les disponibilités. Il faut entendre par pièces de rechange les pièces individuelles électriques ou mécaniques susceptibles de défaillance au cours de leur utilisation normale. Par exemple, les relais, les lampes, les sondes thermiques, les éléments de détecteur, les moteurs, etc. Les parties en tôles, les éléments ou assemblages structurels et les pièces de fonderie, les cartes à circuits imprimés et les modules fonctionnels sont normalement susceptibles d'être remis à l'état neuf pendant toute la durée de leur vie utile et ne sont dès lors fournies, au terme de la production finale des appareils, que suivant les disponibilités.

Service d'assistance à la clientèle

Varian fournit divers services destinés à aider sa clientèle après expiration de la garantie: service de réparation sur base de contrats de maintenance à prix attractifs ou sur base d'accords à durée limitée portant sur du matériel spécifique; support technique et service de formation assurés par des chimistes qualifiés sur base contractuelle ou en fonction des besoins spécifiques.

Points de vente des instruments analytiques Varian

Contactez votre point de vente régional Varian pour toute question commerciale ou de service d'assistance à la clientèle ou pour passer commande de pièces et de fournitures.

Argentina

Buenos Aires
Tel. +54.11.4.783.5306

Australia

Mulgrave, Victoria
Tel. +61.3.9566.1134

Austria

Vösendorf bei Wien
Tel. +43.1.699.9669

Benelux

Bergen Op Zoom
Tel. +31.164.282.800

Brazil and Latin America (S)

São Paulo
Tel. +55.11.820.0444

Canada

Mississauga, Ontario
Tel. 800.387.2216

China

Beijing
Tel. +86.106209.1727

Europe

Middelburg, The Netherlands
Tel. +31.118.671.000

France

Les Ulis Cédex
Tel. +33.1.6986.3838

Germany

Darmstadt
Tel. +49.6151.7030

India

Mumbai
Tel. +91.22.857.0787/88/89

Italy

Torino
Tel. +39.011.997.9111

Japan

Tokyo
Tel. +81.3.5232.1211

Korea

Seoul
Tel. +82.2.345.22452

Mexico and Latin America (N)

Mexico City
Tel. +52.5.523.9465

Russian Federation

Moscow
Tel. +7.095.937.4280

Spain

Madrid
Tel. +34.91.472.7612

Sweden

Solna
Tel. +46.8.445.1620

Switzerland

Varian AG
Tel. +41.848.803.800

Taiwan

Taipei Hsien
Tel. +886.2.698.9555

United Kingdom and Ireland

Walton-on-Thames
Tel. +44.1932.898000

Venezuela

Valencia
Tel. +58.41.257.608

United States

Walnut Creek, California, USA
Tel. +1.800.926.3000
(GC and GC/MS)
Tel. +1.800.367.4752
(LC)



VARIAN

www.varianinc.com

Informazioni sulla Sicurezza

Istruzioni per l'Uso

Questo manuale ha lo scopo di aiutare l'operatore ad utilizzare lo strumento in modo sicuro ed efficiente. Le considerazioni e le precauzioni speciali vengono presentate in questo manuale sotto forma di avvisi di **NOTA**, **CAUTELA** e **ATTENZIONE**. E' importante che lo strumento venga utilizzato rispettando le istruzioni fornite in questo manuale o che verranno fornite successivamente dalla Varian. Per ogni eventuale chiarimento sull'uso o sulla sicurezza, si prega di contattare la Varian di Leinì (TO).

NOTA

Sono informazioni utili ad ottenere le prestazioni migliori da parte dello strumento.



ATTENZIONE

Allerta l'operatore su situazioni che potrebbero causare ferite leggere e danni limitati allo strumento ed il modo di evitarle.



ATTENZIONE

Allerta l'operatore su situazioni potenzialmente pericolose che possono causare danni molto seri ed il modo di evitarle.

Segnali di ATTENZIONE



ATTENZIONE
Pericolo di folgorazioni



ATTENZIONE
ESPOSIZIONE A
SOSTANZA CHIMICHE



ATTENZIONE
Pericolo di scottature



ATTENZIONE
PERICOLO PER
GLI OCCHI



ATTENZIONE
Pericolo di incendio



ATTENZIONE
Pericolo di esplosioni



ATTENZIONE
Pericolo di radiazioni



ATTENZIONE
Parti in movimento

Descrizione del Pericolo

Nello strumento sono presenti tensioni pericolose. Scollegare il cavo di alimentazione prima di togliere il pannello fissato con le viti.

Possono essere presenti composti chimici pericolosi. Evitare il contatto, specialmente quando si riempiono i contenitori. Usare protezioni opportune per la pelle e per gli occhi.

Pericolo di esposizione a superfici molto calde o raffreddate criogenicamente. Usare protezioni opportune per la pelle.

Particelle volanti, agenti chimici o radiazioni UV possono danneggiare gli occhi. Vanno quindi utilizzate le opportune protezioni per gli occhi e per il volto.

Pericolo potenziale di incendio. Seguire le istruzioni del manuale per lavorare con una maggiore sicurezza.

C'è pericolo di esplosioni a causa del tipo di gas o liquido utilizzato.

E' presente una radiazione ionizzante. Seguire le istruzioni del manuale per lavorare con una maggiore sicurezza.

Non tenere le mani o le dita vicino.



Norme di Sicurezza

Per lavorare in modo sicuro sullo strumento, Vi consigliamo di adottare le seguenti procedure.

- Verificare periodicamente che non ci siano perdite sulle linee e sui raccordi pneumatici.
- Evitare che le linee dei gas vengano piegate o forate. Le linee vanno posizionate in modo tale da non essere calpestate e lontane da sorgenti o troppo calde o troppo fredde.
- I solventi organici vanno conservati in armadi speciali antiincendio, ventilati e con indicazioni chiare sul contenuto di materiali tossici e/o infiammabili.
- Non accumulare i solventi utilizzati. Adottare un programma regolare di smaltimento, ma mai nelle acque di scarico.

AVVERTENZA: Questo strumento è stato testato secondo le Direttive EMC allo scopo di poter utilizzare il Marchio CE della Comunità Europea. Questo strumento può essere suscettibile a radiazioni/interferenze o frequenze che non sono entro i limiti collaudati.



ATTENZIONE

Questo strumento è progettato per l'analisi cromatografica di campioni opportunamente preparati. Deve essere utilizzato usando gas e solventi adatti a questo scopo ed entro i limiti massimi di pressione, flusso e temperatura riportati in questo manuale. Se lo strumento non viene utilizzato secondo le modalità specificate dal costruttore, le condizioni di sicurezza previste potranno non essere sufficienti.



ATTENZIONE

E' responsabilità del Cliente informare il Servizio Tecnico Varian, prima di qualsiasi intervento di riparazione, se lo strumento è stato utilizzato per l'analisi di campioni biologicamente pericolosi, radioattivi o tossici.

Pericoli Elettrici

- Prima di togliere i pannelli di protezione, scollegare lo strumento da tutte le alimentazioni elettriche in modo da evitare l'esposizione a voltaggi potenzialmente pericolosi.
- Quando si rende necessario sostituire il cavo di alimentazione, assicurarsi che il nuovo cavo rispetti sia le codifiche di colore e di polarità riportate nel manuale di istruzioni che quelle stabilite dalle norme di sicurezza del laboratorio.
- Sostituire i fusibili bruciati solo con fusibili che abbiano le stesse caratteristiche; queste ultime sono riportate sul pannello dei fusibili e/o nel manuale di istruzioni.
- Sostituire immediatamente i cavi di alimentazione difettosi o consumati con cavi dello stesso tipo e con le stesse caratteristiche.
- Assicurarsi che il voltaggio del pannello di alimentazione corrisponda a quello dello strumento da collegare.

Bombole dei Gas

- Occorre prestare molta attenzione quando si spostano bombole di gas compressi. Rispettare tutte le norme di sicurezza.
- Assicurare le bombole ad una parete o ad una struttura fissa.
- Spostare e conservare le bombole sempre in posizione verticale. Togliere i manometri prima di spostare le bombole.
- Conservare le bombole in un'area ben ventilata, non infiammabile, lontana da sorgenti di calore, non esposta a temperature troppo fredde o alla luce diretta del sole.
- Evidenziare in modo chiaro e che non lasci dubbi il contenuto di ogni bombola.
- Usare solo manometri e raccordi di qualità.
- Usare solo tubazioni cromatograficamente pulite (Numero di Parte Varian 03-918326-00) e calibrate per pressioni superiori a quella massima di uscita dal manometro.

Procedure di Sicurezza in GC

Scarico dei Gas

Per i rivelatori GC non è richiesto alcun sistema particolare di scarico dei gas, se lo strumento è installato in una stanza ben ventilata e se non viene utilizzato per l'analisi di sostanze chimiche pericolose. Se si deve installare un sistema di scarico dei gas:

- Usare condutture non infiammabili
- Installare un aspiratore in uscita
- Posizionare la presa d'aria in modo che le vibrazioni e il movimento dell'aria non disturbino il rivelatore.
- Eseguire verifiche periodiche per garantire un funzionamento corretto.
- Garantire una buona ventilazione nel laboratorio.

Rivelatori a Sorgente Radioattiva

- Leggere e rispettare tutte gli avvisi di **NOTA**, **CAUTELA** e **ATTENZIONE** riportati nel manuale del rivelatore ECD al Ni⁶³.
- Eseguire tutti i test di contaminazione radioattiva rimovibile descritti nel manuale dell'ECD al Ni⁶³.
- Rispettare tutte le procedure e le scadenze di verifica per eventuali perdite.

Pericolo di Scottature

Le zone calde o raffreddate criogenicamente del gascromatografo possono mantenere la loro temperatura per parecchio tempo, dopo aver spento lo strumento. Per evitare scottature, assicurarsi che le zone riscaldate o raffreddate siano a temperatura ambiente oppure indossare delle protezioni adeguate prima di toccare tali superfici.

Procedure di Sicurezza in LC

Pericolo di Alte Pressioni

In caso di rottura di una linea o di apertura accidentale di una valvola, quando il sistema è sotto pressione, la pompa può liberare liquidi tossici e/o volatili molto pericolosi.

- E' opportuno adottare un sistema di protezione del viso quando si inietta il campione o si esegue una manutenzione routinaria del sistema.

- Non smontare mai una linea del solvente od una valvola quando il sistema è sotto pressione. Fermare prima la pompa ed aspettare che la pressione scenda a zero.
- Usare dei contenitori per solventi infrangibili ed in grado di lavorare a 50-60 psi.
- Quando i contenitori sono sotto pressione, usare una protezione esterna.
- Leggere e rispettare tutti gli avvisi di **NOTA**, **CAUTELA** e **ATTENZIONE**.

Cromatografia Flash

L'operatore deve conoscere le proprietà fisico-chimiche delle componenti della fase mobile.

I solventi non vanno messi in contatto diretto con il tubo di erogazione in poliuretano, dal momento che alcuni solventi possono causare indebolimento e perdite con possibili scoppi.

Tutte le componenti del sistema vanno collegate ad una fonte di alimentazione e ad una messa a terra comuni. E' meglio che per quest'ultima venga utilizzata una spina con polo di terra.

I solventi non-polari possono sviluppare una carica statica quando vengono pompate attraverso il sistema. Tutti i recipienti che contengono la fase mobile (inclusi i tubi e i recipienti di raccolta) devono avere una messa a terra per disperdere l'elettricità statica.

Vanno utilizzati dispositivi di misurazione e scarico (ad esempio ionizzatori d'aria) per evitare l'aumento di elettricità statica.

Radiazioni Ultraviolette

I rivelatori di cromatografia liquida che usano sorgenti a luce ultravioletta montano degli schermi di protezione per evitare che gli operatori siano esposti a radiazioni pericolose.

Per una protezione sicura:

- Assicurarsi che i coperchi delle lampade dei rivelatori a lunghezza fissa e variabile siano sempre al loro posto, quando si lavora.
- Non guardare mai direttamente dentro le celle o alla sorgente di luce UV. Quando si vuole ispezionare la lampada o le celle, usare sempre delle protezioni adatte per gli occhi, quali vetro in borosilicato e polistirolo.

Disponibilità delle Parti di Ricambio

E' politica della Varian il fornire le parti di ricambio per lo strumento ed i suoi accessori per un periodo di cinque (5) anni a partire dalla data di produzione dell'ultima unità della serie. Le parti di ricambio saranno disponibili anche dopo questo periodo di cinque (5) anni ma solo in base alla disponibilità delle stesse. Per parti di ricambio si intendono i componenti elettrici e meccanici soggetti ad usura durante l'uso, in condizioni normali, dello strumento. Come esempio, citiamo i relay, le lampade, i probe di temperatura, i componenti del rivelatore, i motorini, ecc. Le parti strutturali o da fusione, le schede elettroniche ed i moduli funzionali possono essere ricostruiti e rimessi a nuovo durante tutto il loro periodo di vita e perciò sarà possibile acquistarli, dopo la produzione dell'ultima unità delle serie, solo in base alla loro disponibilità.

Servizi Tecnico

La Varian, alla scadenza del periodo di garanzia, è in grado di fornire ai suoi clienti un'ampia scelta di opzioni. Le riparazioni possono essere effettuate sulla base di contratti di manutenzione particolarmente vantaggiosi od in base ad una tariffa oraria piu' il costo delle parti. A richiesta, si possono avere corsi per operatori sia sotto forma di contratto che a tariffe da concordare.

Uffici Vendite della Divisione Strumenti Analitici della Varian

Per informazioni relative alla Vendita, al Servizio Tecnico o all'acquisto di Parti di ricambio, si prega di contattare l'ufficio Varian piu' vicino.

Argentina

Buenos Aires
Tel. +54.11.4.783.5306

Australia

Mulgrave, Victoria
Tel. +61.3.9566.1134

Austria

Vösendorf bei Wien
Tel. +43.1.699.9669

Benelux

Bergen Op Zoom
Tel. +31.164.282.800

Brazil and Latin America (S)

São Paulo
Tel. +55.11.820.0444

Canada

Mississauga, Ontario
Tel. 800.387.2216

China

Beijing
Tel. +86.106209.1727

Europe

Middelburg, The Netherlands
Tel. +31.118.671.000

France

Les Ulis Cédex
Tel. +33.1.6986.3838

Germany

Darmstadt
Tel. +49.6151.7030

India

Mumbai
Tel. +91.22.857.0787/88/89

Italy

Torino
Tel. +39.011.997.9111

Japan

Tokyo
Tel. +81.3.5232.1211

Korea

Seoul
Tel. +82.2.345.22452

Mexico and Latin America (N)

Mexico City
Tel. +52.5.523.9465

Russian Federation

Moscow
Tel. +7.095.937.4280

Spain

Madrid
Tel. +34.91.472.7612

Sweden

Solna
Tel. +46.8.445.1620

Switzerland

Varian AG
Tel. +41.848.803.800

Taiwan

Taipei Hsien
Tel. +886.2.698.9555

United Kingdom and Ireland

Walton-on-Thames
Tel. +44.1932.898000

Venezuela

Valencia
Tel. +58.41.257.608

United States

Walnut Creek, California, USA
Tel. +1.800.926.3000
(GC and GC/MS)
Tel. +1.800.367.4752
(LC)



VARIAN

www.varianinc.com

Instrucciones de Seguridad

Instrucciones de Operación

Este Manual de Instrucciones está diseñado para ayudarle a establecer las condiciones de operación que le permitan operar su instrumento de forma segura y eficaz. Así mismo, se describen consideraciones especiales ó precauciones, que aparecen en forma de **NOTA**, **PRECAUCION**, y **ATENCIÓN** como se indica más abajo. Es importante que utilice el instrumento de acuerdo con este Manual de Operación y cualquier otra información que le proporcione Varian. Remita a la Oficina Local de Varian cualquier cuestión que tenga respecto al correcto uso de su equipo.

NOTA

Información para ayudarle a obtener unas prestaciones óptimas de su instrumento.



¡PRECAUCION!

Le alerta de situaciones que pueden causar daños moderados a la salud ó al equipo, y cómo evitar esas situaciones.



ATENCIÓN

Le alerta de potenciales situaciones peligrosas que pueden causar serios daños, y cómo evitar esas situaciones.

Símbolo



ATENCIÓN
PELIGRO DE
DESCARGA ELÉCTRICA

Descripción

El instrumento utiliza voltajes peligrosos. Desconecte el interruptor general antes de retirar los paneles atornillados.



ATENCIÓN
PELIGRO QUÍMICO

Peligro de productos químicos. Evite el contacto, especialmente cuando rellene los depósitos. utilice protección de ojos y piel.



ATENCIÓN
PELIGRO DE
QUEMADURAS

Superficies posiblemente calientes ó frías (criogénico). Utilice protección para la piel.



ATENCIÓN
PELIGRO PARA LOS OJOS

Las partículas volátiles, productos químicos o radiación UV pueden causar daños en los ojos. Usar las debidas protecciones para la cara y los ojos.



ATENCIÓN
PELIGRO DE FUEGO

Peligro potencial de fuego. Siga las instrucciones del Manual de Operación para su seguro funcionamiento.



ATENCIÓN
PELIGRO DE EXPLOSIÓN

Peligro potencial de explosión debido al tipo de gas ó líquido empleado.



ATENCIÓN
PELIGRO DE RADIACIÓN

Peligro por Fuente de radiación. Siga las instrucciones del Manual de Operación para su seguro funcionamiento.



ATENCIÓN
PARTES EN MOVIMIENTO

Mantenga alejados los dedos y las manos.



VARIAN

Precauciones Generales de Seguridad

Siga estas indicaciones de seguridad para una correcta operación del equipo.

- Realice verificaciones periódicas de fugas en todas las líneas de suministro y tuberías.
- No permita que las líneas de gas se doblen ó pinchen. Manténgalas alejadas de zonas de paso y del calor ó frío excesivo.
- Guarde los disolventes orgánicos en cabinas ventiladas, a prueba de fuego, y etiquetadas para que puedan ser fácilmente identificadas como material tóxico y/ó inflamable.
- No acumule disolventes inservibles. Deseche todo el material inservible a través de un programa especial de desechos y no a través del sistema convencional.

NOTA: Este instrumento ha sido testado bajo las normas de la Directiva EMC según requerimientos de la Marca CE de la Unión Europea. Por lo tanto, este equipo puede ser sensible a niveles de radiaciones / interferencias ó frecuencias que no estén incluidas dentro de los límites testados.



ATENCIÓN

Este instrumento está diseñado para análisis cromatográfico de muestras preparadas apropiadamente. Debe ser operado usando gases y/ó disolventes apropiados y con unos niveles máximos de presión, flujos y temperaturas, según se describe en este manual.



ATENCIÓN

El Usuario tiene la obligación de informar al Servicio Técnico de Varian cuando el instrumento vaya a ser empleado para análisis de muestras peligrosas de origen biológico, radioactivo ó tóxico, antes de comenzar a realizar cualquier análisis.

Peligros Eléctricos

- Desconecte el instrumento de todos las conexiones eléctricas a la red antes de retirar los paneles para evitar la posible exposición a peligrosos voltages.
- Cuando sea necesario emplear una clavija eléctrica no original, asegurese de colocar los cables de acuerdo con el código de colores y polaridades descritos en el manual y los códigos de seguridad de la red eléctrica.
- Sustituya los fusibles fundidos con fusibles del tipo y tamaño estipulados en el panel de fusibles ó en el manual.
- Sustituya los cables deteriorados inmediatamente con cables del mismo tipo y graduación.
- Asegureses de que los valores de las líneas de electricidad se ajustan a los valores para los que el Instrumento ha sido preparado.

Botellas de Gas Comprimido

- Guarde y maneje las botellas de gas con cuidado y de acuerdo con las normas de seguridad.
- Asegure las botellas a una estructura inmóvil ó a la pared.
- Guarde y mueva las botellas en posición vertical. Retire los reguladores antes de transportarlas.
- Guarde las botellas en un área ventilada, lejos de fuentes de calor, de luz solar directa y de temperaturas extremadamente bajas.
- Identifique las botellas claramente para evitar cualquier duda sobre su contenido.
- Utilice sólo reguladores y conexiones aprobadas.
- Utilice sólo tubos de conexión cromatográficamente limpios (Varian p/n 03-918326-00) y que tengan una graduación de presión significativamente mayor que la mayor presión del regulador.

GC Prácticas de Seguridad

Sistema de Extracción

No se necesita un sistema de extracción para los detectores GC instalados en un laboratorio bien ventilado, excepto cuando se analicen muestras químicas peligrosas. Si instala un sistema de extracción:

- Utilice conductos a prueba de fuego.
- Instale un ventilador al final del sistema.
- Instale entradas de aire cuya vibración no afecte al trabajo del detector.
- Compruebe periódicamente el correcto funcionamiento del sistema.
- Asegurese de una correcta ventilación del laboratorio.

Detectores con fuentes radioactivas

- Lea con cuidado y cumpla todas las **NOTAS**, **PRECAUCION**, y **ATENCION** del Manual del Detector Ni⁶³ ECD.
- Realice los test de contaminación radioactiva descritos en el Manual del Detector Ni⁶³ ECD.
- Cumpla con los plazos y procedimientos de test de fugas.

Peligro de Quemaduras

Las zonas de calor ó frío (criogénicas) del Cromatógrafo de Gases pueden permanecer calientes ó frías durante bastante tiempo después de apagar el instrumento. Para evitar quemaduras asegureses de que todas las áreas que se calienten ó enfríen han vuelto a la temperatura ambiente, ó protejase adecuadamente las manos, antes de tocar las superficies potencialmente calientes ó frías.

LC Prácticas de Seguridad

Peligro de Alta Presión

Si se rompe una línea de presión, ó se abre una válvula de seguridad accidentalmente bajo presión, la bomba puede generar líquidos a alta presión potencialmente peligrosos, produciendo un chorro a alta velocidad de líquidos volátiles y/ó tóxicos.

- Lleve protección facial cuando inyecte muestras ó realice mantenimiento de rutina.

- Nunca abra una línea ó una válvula bajo presión. Apague la bomba antes y deje que la presión baje a cero.
- Utilice depósitos irrompibles que sean capaces de operar a 50-60 psi.
- Mantenga cerrada la junta del depósito cuando se haya bajo presión.
- Lea y cumpla todas las **NOTA**, **PRECAUCION**, y **ATENCION** del manual.

Cromatografía Flash

El operador debe familiarizarse con las propiedades físico-químicas de los componentes de la fase móvil.

Alejar los disolventes del contacto directo con los tubos de poliuretano ya que ciertos disolventes pueden causar reblandecimiento de los tubos o posibles fugas con riesgo de explosión.

Todos los componentes del sistema deben estar conectados a un enchufe común con toma de tierra común. Esta toma de tierra debe ser una toma de tierra verdadera en lugar de flotante.

Los disolventes no-polares pueden originar carga estática cuando son bombeados por el sistema. Todos los recipientes que contienen fase móvil (incluyendo los tubos y los recipientes de recogida) deben estar conectados a tierra para disipar la electricidad estática.

Utilizar medidores de carga estática y los debidos dispositivos de descarga (por Ej., ionizadores de aire) para salvaguardarse contra la creación de electricidad estática.

Radiación Ultravioleta

Los detectores del Cromatógrafo de Líquidos que utilizan una fuente de luz ultravioleta disponen de protección para prevenir exposiciones radioactivas al personal.

Para una correcta protección:

- Asegurese de que las cubiertas de protección de la lámpara de los detectores está correctamente situada durante su funcionamiento.
- No mire directamente a las celdas del detector ó a la fuente de luz UV. Cuando inspeccione la fuente de luz ó la celda, utilice siempre una protección para los ojos como gafas de borosilicato ó poliestireno.

Disponibilidad de Recambios

Es Política de Varian disponer de Recambios para cualquier instrumento y la mayoría de los accesorios por un periodo de cinco (5) años después del último instrumento fabricado. Los recambios durante esos cinco años estarán disponibles, pero siempre bajo el sistema “*Según disponibilidad*”. Los Recambios están definidos como todas aquellas partes individuales mecánicas ó eléctricas que son susceptibles de fallo durante su normal proceso de operación. Por ejemplo, relés, lámparas, sondas de temperatura, elementos del detector, motores, etc. Las planchas de metal, partes de la estructura, placas de circuitos integrados, y otros módulos funcionales son normalmente susceptibles de reparación y por lo tanto sólo estarán disponibles bajos el sistema “*Según disponibilidad*” después del último instrumento fabricado.

Disponibilidad de Servicio

Varian ofrece una gran variedad de sistemas de Servicio para mantener el soporte a sus usuarios tras el periodo de garantía. El Soporte de Servicio se ofrece a través de atractivos Contratos de Servicio ó bajo un sistema de facturación de mano de obra y materiales. El mantenimiento y el entrenamiento se realiza por ingenieros cualificados bajo Contrato ó petición.

Oficinas de Instrumentación Analítica Varian

Para cualquier consulta sobre Instrumentación Analítica, Servicio Técnico ó Recambios y Accesorios, contacte con su oficina local:

Argentina

Buenos Aires
Tel. +54.11.4.783.5306

Australia

Mulgrave, Victoria
Tel. +61.3.9566.1134

Austria

Vösendorf bei Wien
Tel. +43.1.699.9669

Benelux

Bergen Op Zoom
Tel. +31.164.282.800

Brazil and Latin America (S)

São Paulo
Tel. +55.11.820.0444

Canada

Mississauga, Ontario
Tel. 800.387.2216

China

Beijing
Tel. +86.106209.1727

Europe

Middelburg, The Netherlands
Tel. +31.118.671.000

France

Les Ulis Cédex
Tel. +33.1.6986.3838

Germany

Darmstadt
Tel. +49.6151.7030

India

Mumbai
Tel. +91.22.857.0787/88/89

Italy

Torino
Tel. +39.011.997.9111

Japan

Tokyo
Tel. +81.3.5232.1211

Korea

Seoul
Tel. +82.2.345.22452

Mexico and Latin America (N)

Mexico City
Tel. +52.5.523.9465

Russian Federation

Moscow
Tel. +7.095.937.4280

Spain

Madrid
Tel. +34.91.472.7612

Sweden

Solna
Tel. +46.8.445.1620

Switzerland

Varian AG
Tel. +41.848.803.800

Taiwan

Taipei Hsien
Tel. +886.2.698.9555

United Kingdom and Ireland

Walton-on-Thames
Tel. +44.1932.898000

Venezuela

Valencia
Tel. +58.41.257.608

United States

Walnut Creek, California, USA
Tel. +1.800.926.3000
(GC and GC/MS)
Tel. +1.800.367.4752
(LC)



VARIAN

www.varianinc.com

Contents

Introduction.....	5
Principles of Operation	7
General Description	7
Transfer Line.....	9
Analyzer.....	10
Internal Ionization	10
External Ionization.....	12
Hybrid Ionization	14
Ion Trap.....	14
Detector.....	15
Vacuum System.....	17
Vacuum Manifold	17
Foreline Pump.....	17
Turbomolecular Vacuum Pump	17
Ion Gauge.....	18
Thermocouple Gauge	18
Pneumatic.....	19
Helium Damping Gas Flow	20
Calibration Gas Flow.....	20
CI Reagent Gas Flow.....	20
Electronics	21
Controller.....	22
Power Board	23
Manifold Electronics.....	23
RF Generator Assembly.....	24
Ion Detection Board	25
Ion Amplifier	25
Electronic Flow Control	25
Power Input Subsystem	25
Main Power Circuit.....	25
Rotary Vane Pump Maintenance	27
Maintenance Schedule	27
Checking Oil Level and Condition	27
Changing Foreline Pump Oil	27
Setting Up for the Oil Change	28
Changing the Oil	29
Flushing the Pump Oil.....	29
Changing the Oil Mist Cartridge	30
Checking the Cooling Fans	31
Dry Scroll Pump Routine Maintenance.....	33
Maintenance Schedule	33

Purging the Pump.....	33
Replacing the Tip Seals.....	33
Removing Worn Tip Seals	33
Installing New Seals and O-ring.....	34
Testing the Pump	34
MS Maintenance Procedures.....	37
General Recommendations.....	37
Tools and Materials	37
Common Procedures.....	38
Turning Off the MS.....	38
Using Nitrogen Purge.....	40
Moving MS Away from GC.....	41
Removing the Analyzer Assembly	41
Removing the Source and Ion Trap Assembly	43
Reinstalling the Source and Ion Trap Assembly	44
Reinstalling the Analyzer Assembly.....	47
Turning On the MS.....	49
Checking the Vacuum Status.....	50
Baking Out the MS.....	51
Checking Ion Trap Operation.....	51
Cleaning Procedures	52
Cleaning the External Source	52
Cleaning the Internal Ionization Assembly.....	61
Cleaning Ion Trap Components	65
Replacing GC Columns.....	70
Removing the Capillary Column	71
Installing New Capillary Columns	72
Replacing Components	75
Replacing External Source Filaments.....	75
Conditioning the Filaments.....	77
Replacing Internal Source Filaments.....	77
Replacing the Electron Multiplier	78
Replacing the Damping Gas Getter	81
Replacing the Turbomolecular Pump.....	81
Filling the Calibration Gas Vial.....	81
Changing Ionization Mode.....	83
Changing from Internal to External Mode	83
Changing from External to Internal Mode	83
Changing from Internal to Hybrid Mode	83
Changing from External to Hybrid Mode.....	83
Switching Between External and Internal Sources	84
Changing the Transfer Line from External to Internal.....	84
Changing the Transfer Line from Internal to External.....	86
Installing or Removing the Hybrid Plug.....	87
Chemical Ionization Options	89
Introduction.....	89
Internal CI.....	89
External CI.....	89
Hybrid CI	90
Installing CI Reagent Gas.....	90
CI Reagent Gas Requirements.....	91
Setting Up the CI Reagent Gas Supply	91

Checking the Reagent Gas Plumbing for Leaks	94
Setting CI Reagent Flow for Internal Mode	95
Parameters for CI Internal Mode.....	95
CI Reagents External Mode Default Parameters.....	95
Ion Intensities for Standard CI Reagents	96
Setting CI Reagent Flow for External Mode	96
Setting CI Reagent Flow for Hybrid Mode	96
Liquid CI Inlet Option	97
Switching from Gaseous to Liquid CI Reagent	97
Filling the Reservoir Bulb	97
Switching from Liquid to Gaseous CI Reagent Operation	98
Troubleshooting	99
Isolating a GC/MS Problem	99
Checking the Data System	99
Checking the GC	99
Checking the MS	99
Troubleshooting Spectra	100
No Spectrum Appears.....	100
Loss of High Mass Peaks.....	101
Missing a Section of the Spectrum	101
Poor Resolution with Acceptable Air and Water Levels.....	101
Troubleshooting High Baseline at High Masses	102
Checking for Leaks.....	102
Preparing for Leak Checking	102
Diagnosing the System	103
Fixing a Major Air Leak	104
Fixing a Minor Air Leak	104
Checking GC Connections.....	104
Troubleshooting Air Leaks Using Leak Detection Gas	105
Fixing High Water Levels.....	106
Using the Column Test Mixture for Troubleshooting	106
Column Test Mixture	106
Method Parameters COLTEST Mixture	107
Troubleshooting Chromatographic Problems	107
Solvent Tailing or Broadening Problems.....	108
Peak Tailing of Active Components	108
Low Response or Severe Tailing of High B P Compounds	108
Leading Sample Peaks (Reverse Tailing).....	108
Poor Resolution.....	109
Peak Size not Reproducible.....	109
Peak Splitting (Particularly for Low Boilers).....	109
Extra, Unexpected Peaks.....	109
Retention Time Differences Between Runs.....	110
Documents, Parts and Supplies.....	111
Other Documents.....	111
Parts and Supplies.....	111
Electronics.....	111
Pneumatics	112
Analyzer Attached to Top Flange.....	112
Analyzer Attached to Manifold	113
Chemical Ionization.....	113
Vacuum	113

O-Rings	114
Miscellaneous/Other	114
Standards and Test Samples.....	115
Varian Service	116
Appendix 1: Setup of Synchronization Signals for External Modules	117
Overview	117
Synchronization Signals	117
Input Schematic	118
Synchronization Signal Output Schematic.....	118
Synchronization Signal Characteristics.....	119

Introduction

This hardware manual has six sections. The first section describes the operating principles of the spectrometer and provides details of the instrument subsystems. The next two sections include details about the maintenance procedures. The fourth section describes the installation and operation of the chemical ionization source. The fifth section provides troubleshooting procedures and the final section provides information about moving the instrument and has a list of the spare parts.

Principles of Operation

General Description

The mass spectrometer, (MS), is housed in a vacuum manifold surrounded by electronics. The electronics drive the analyzer operation and acquire the data. The major functional areas are the source, ion trap, and detector.

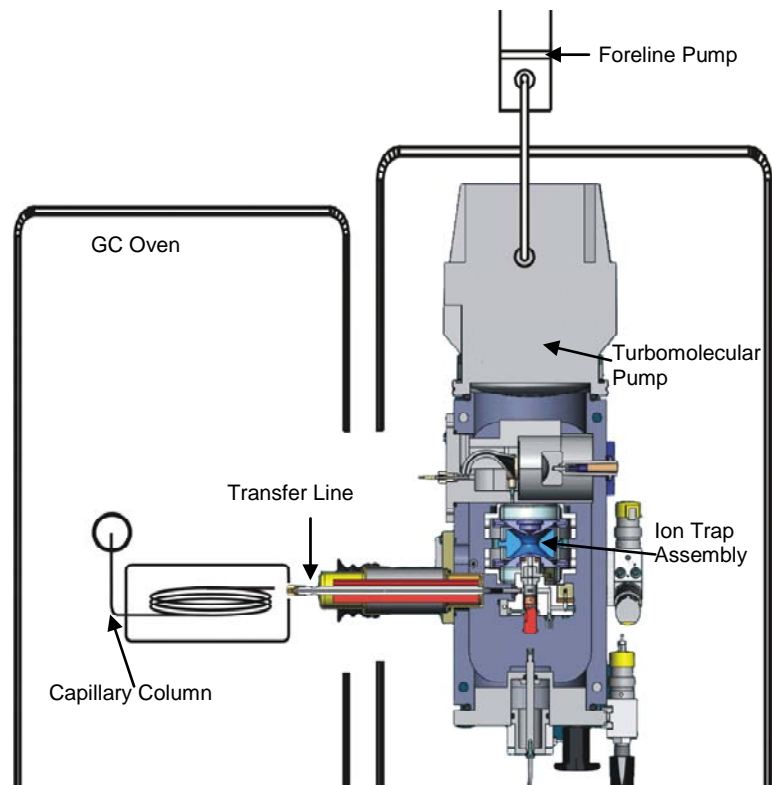

Samples injected into the GC are vaporized and the gas goes through a column in the GC oven. In the column, the sample separates into its components and the components enter the MS through a heated transfer line. The line is heated to prevent the sample from condensing.

From the transfer line, the components go either into an external source, where the sample is ionized, or directly into the ion trap for ionization. After ionization, the ions are stored in the ion trap where they are systematically ejected for analysis. After the ions are ejected, the detector (consisting of a conversion dynode and electron multiplier) registers them.

The turbomolecular and foreline pumps create the necessary vacuum and the vacuum manifold maintains it. Various pneumatics devices send the required gases into the vacuum manifold. An ion gauge and thermocouple gauge measure the vacuum levels in the manifold and foreline respectively.

The vacuum manifold is on top of an RF coil assembly. The electronic components of RF generation and ion detection are around the RF coil assembly. Some source and trap related electronics are in an enclosure positioned on the vacuum manifold top flange. A system controller and power board are in an enclosure formed by a central bulkhead and outer cover.



**WARNING:
SHOCK HAZARD**

High voltages: No user serviceable parts are under screw-attached covers. Contact your local Varian representative for instrument repair and service.

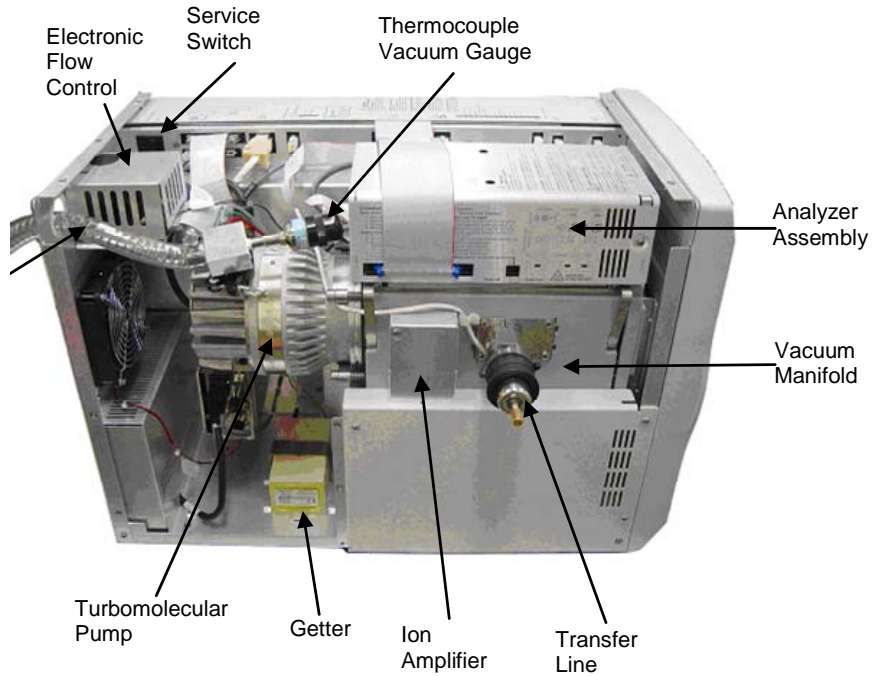

Transfer Line

A stainless steel tube transfer line couples the GC to the mass spectrometer. A heater in the line keeps the GC column warm to prevent the sample from condensing, which could result in tailing. The transfer line consists of a stainless steel body fitted with a center tube, a heat exchanger, and a boot. The heat exchanger is an aluminum cylinder that has a cartridge heater and a thermocouple as the temperature sensor. The temperature sensor measures the temperature of the tube. The cartridge heater heats the cylinder, which distributes heat evenly throughout the length of the transfer line tube. The boot of the transfer line, which mates to the GC, prevents hot air from leaking from the GC oven.

One end of the transfer line enters a hole in the right side of the GC before passing into the GC oven. The other end enters the vacuum manifold in one of two positions:

- External source ionization-- the transfer line goes into the ion volume.
- Internal ionization-- the transfer line goes into a hole in the trap close to a filament that generates electrons.

The GC column is extended with a tip.

- External ionization uses a long metal tip.
- Internal ionization uses a short polyimide tip.

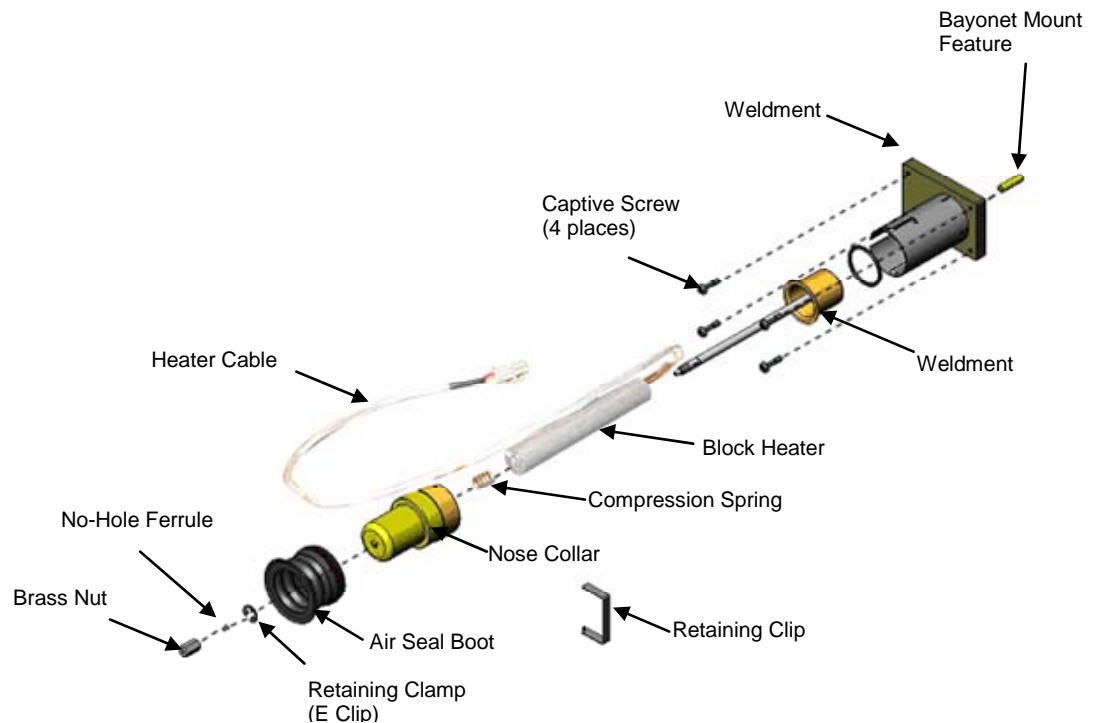

A bayonet mount secures the transfer line. Before removing the trap, push the bayonet mount gently while twisting it counterclockwise, and pull the transfer line out. Ensure that the transfer line extends out from the trap.



Failing to remove the transfer line before removing the trap may damage the transfer line tip.

A heater cable connects the power board to the cartridge heater and projects from the end of the transfer line. It plugs into a soft-shell connector on the top of the power board panel.

The transfer line temperature is set in the Temperature Dialog in System Control. The maximum temperature that the transfer line can sustain is 350 °C; the minimum temperature is 30 °C below the maximum column operating temperature without causing adverse chromatographic effects such as shifting retention times or peak broadening.

Analyzer

The Analyzer consists of the following:

- Internal Ionization Assembly or External Source Assembly.
- Ion Trap.
- Conversion Dynode/Electron Multiplier Detector.

All components of the Analyzer Assembly, except for the detector, are mounted on a flange that has an enclosure holding the analyzer electronics.

- For Internal Ionization, the Internal Ionization Assembly is attached to the Ion Trap Assembly and is called the Source or Ion Trap Assembly.
- For External Ionization, the External Source Assembly is attached to the Ion Trap Assembly and is called the Source or Ion Trap Assembly.

Internal Ionization

In the internal ionization mode, ions are generated in the ion trap. Electrons for ionization are produced and gated by an internal ionization source that resides just outside the entrance electrode of the ion trap. The source consists of a filament assembly and an electron gate electrode with associated mounting hardware. It is held on a U-shaped structure that also holds collimating magnets for external ionization.

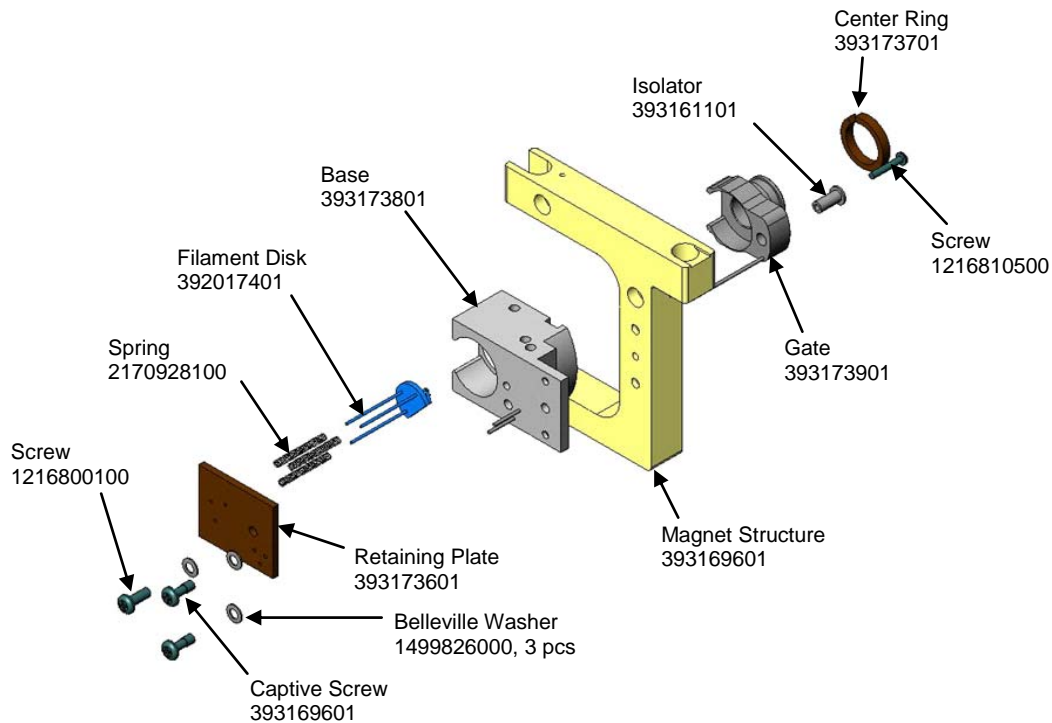

The filament assembly has two filaments and a repeller plate. The filaments are mounted side-by-side and each filament is about equidistant from the entrance hole of the electron focusing lens of the oven. The 240-MS uses one filament at a time; the extra filament is provided if the first one burns out. The repeller plate is a stainless steel plate held at a lower potential than the filament to repel the electrons into the trap.

Each filament is a rhenium ribbon. When heated sufficiently by electric current, the filament produces electrons by thermionic emission. The filament emission current is the flow of emitted electrons from the filament. The filament emission current is set in the Internal EI or CI Properties tab dialog and the settings range from 5 to 100 μA .

NOTE: The signal amplitude generated by each filament is different. A typical difference is 2:1, but it may be as high as 5:1.

The electron gate is a cylindrical electrode that controls the entry of electrons into the ion trap. When electrons, emitted from the heated filament are not needed for ionization, the electron gate is held at a potential of -150V dc. An anodized layer insulates the electron gate from the filament end cap.

When electrons are required for ionization, the electron gate potential changes from -120 to +120V dc. While the gate potential is positive (range 0 usec to 65 msec), the electrons are focused into the ion trap with enough energy to ionize the sample molecules or the reagent gas molecules.

External Ionization

In the external ionization mode, positive or negative ions are generated outside the trap in an external source and then injected into the trap. The external source also produces reagent ions for hybrid ionization, which ionize the sample inside the trap. The external source is an assembly consisting of an ion volume surrounded by two filament assemblies, a set of lenses, a collimating magnet, and a heater, all supported by a source block.

After the sample enters the source ion volume, it is ionized. The system uses both low and high-pressure ion volumes. Electron ionization (EI) uses the low-pressure ion volume. Chemical ionization (CI) uses the high-pressure ion volume. Both volumes are thin, stainless steel cylinders that are chrome plated to minimize reactions with the sample. The low-pressure volume is open at the end facing the trap. The high-pressure CI volume has a small hole to allow ions to be entrained in the gas stream that flows from the volume. Both volumes have additional holes through which the ionizing electrons and the sample molecules enter. The CI volume has an additional opening for the CI reagent. The CI volume is inserted into the EI volume using a pneumatically activated plunger controlled by the software.

One of two filament assemblies generates electrons that ionize the sample during Electron Ionization (EI) or the reagent gas during Chemical Ionization (CI). Each assembly has a rhenium filament sandwiched between a repeller plate and electron lens, supported by a ceramic base. The filament generates electrons through thermionic emission resulting from the heat generated by current flowing through the filament. During ionization, the repeller is set to a negative voltage and the electron lens to a positive voltage to gate electrons into the source. When ionization is not taking place, these voltages are reversed to prevent electrons from entering the source. This patented pulsed ionization technique reduces ion noise during mass scanning and reduces contamination of the ion volume. The repeller and electron lens voltages must be properly balanced, by an Auto Tune routine, to keep the electron current stable during switching. In addition to gating electrons into the ion volume, the electron lens focuses the electron beam. To focus the electron beam further, two magnets, adjacent to each filament assembly, collimate electrons into the source.

After the sample is ionized, three lenses direct the resulting ions towards the ion trap using electrostatic focusing. For EI, the first lens also extracts ions from the source.

The center lens (L2) also gates the ions into the trap by changing its polarity. The lenses are nickel-plated stainless steel cylinders with an anodized insulating layer to prevent the lens from shorting together. Each lens has a voltage connecting post.

A heater maintains the source at an elevated temperature. Electrical connections are made to the source through a flexible printed circuit cable that connects to the electronics through a printed circuit board mounted to the top flange. A heat shield between the source and the flexible cable protects the solder joints.

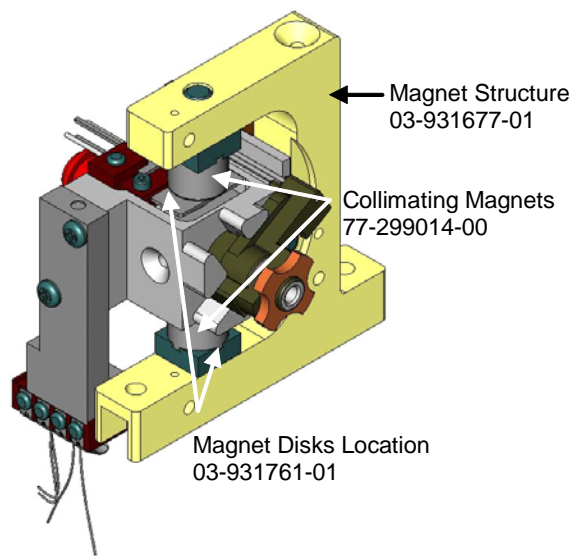
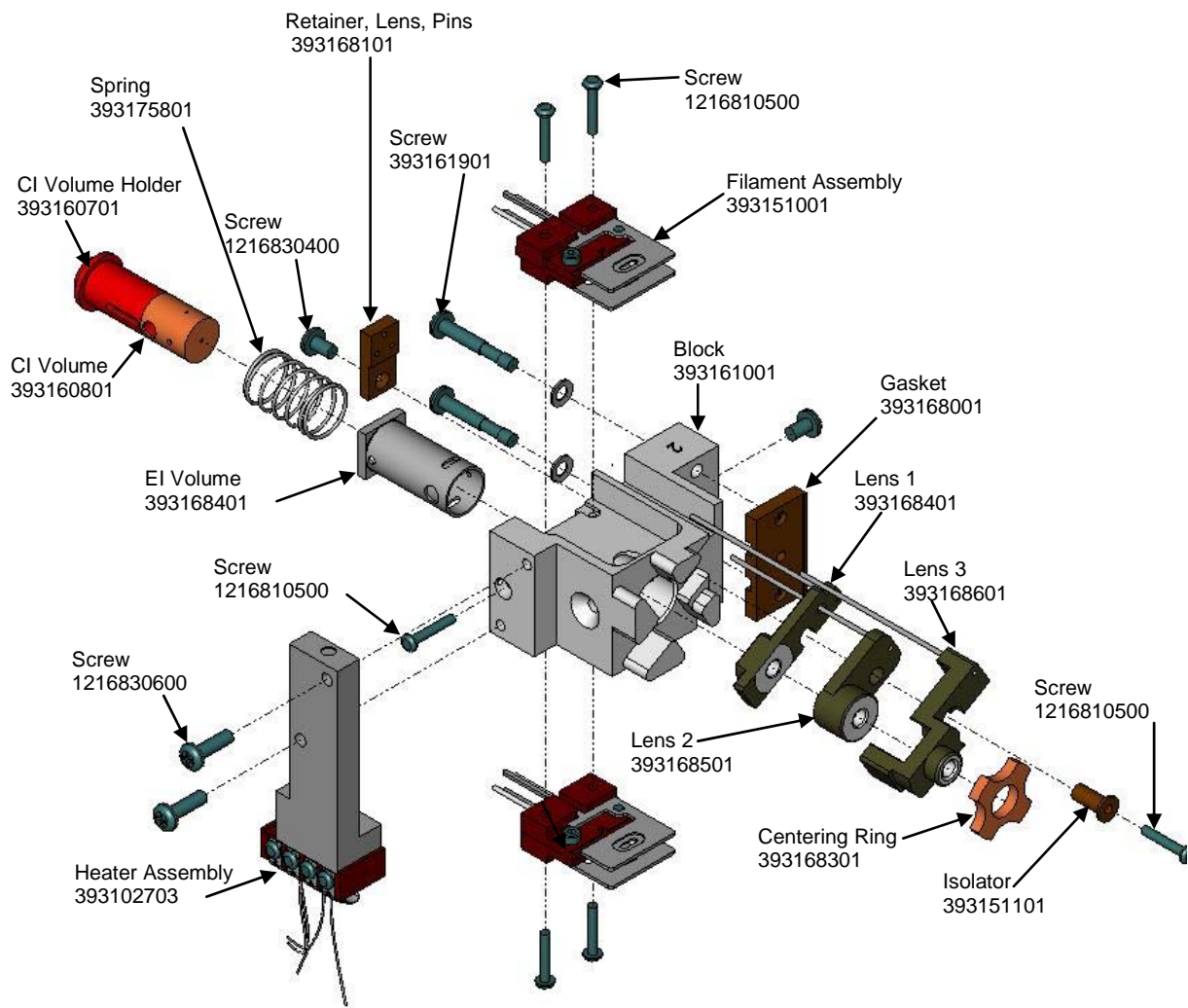

Hybrid Ionization

In hybrid chemical ionization mode, reagent ions, generated in the external source, enter the ion trap and react with analytes from the GC column. The advantages include the following:

- Avoiding ion molecule reactions with the neutral reagent.
- Avoiding the loss of negative ions while they move from the external source to the trap.

The hybrid mode uses the external ionization source and a security chip. In the hybrid mode, the external source must be in place and the transfer line must be positioned with the sample directly entering the ion trap.

Ion Trap

The ion trap assembly has three electrodes separated by quartz spacers contained in a heated oven. They are the entrance, ring, and exit electrodes and have hyperbolic inner surfaces. When assembled, they form a cavity for ionization, fragmentation, storage, and mass analysis to occur.

There is a hole in the center of the entrance and exit-end cap electrodes.

- When the system is configured for internal ionization, the ionizing electrons go in the entrance electrode hole.
- When in external and hybrid ionization modes, the hole in the entrance end cap is the sample inlet.

The ions leave through the hole in the exit-end cap and go to the detector. Holes, in the edge of the end caps, are for banana plugs, which contact with springs that carry supplemental waveform signals.

Between the entrance and exit-end cap and the trap oven plates are four identical quartz or silica-coated spacers. The trap oven and its clamping plate hold the electrodes and spacers in place.

The RF generator assembly provides high voltage 1 MHz RF voltage that is applied to the RF ring electrode through a feed-through on the underside of the vacuum manifold. With the proper RF voltage, the ion trap electrodes create a three-dimensional, hyperbolic electric field. This field traps the ions in stable orbits. In the presence of helium damping gas, the ions are cooled towards the center of the trap. As the RF voltage increases, the ion trajectories become unstable in increasing order of mass to charge ratio. The ion trap ejects the ions, sends them to the conversion dynode, and then to the electron multiplier where they are detected.

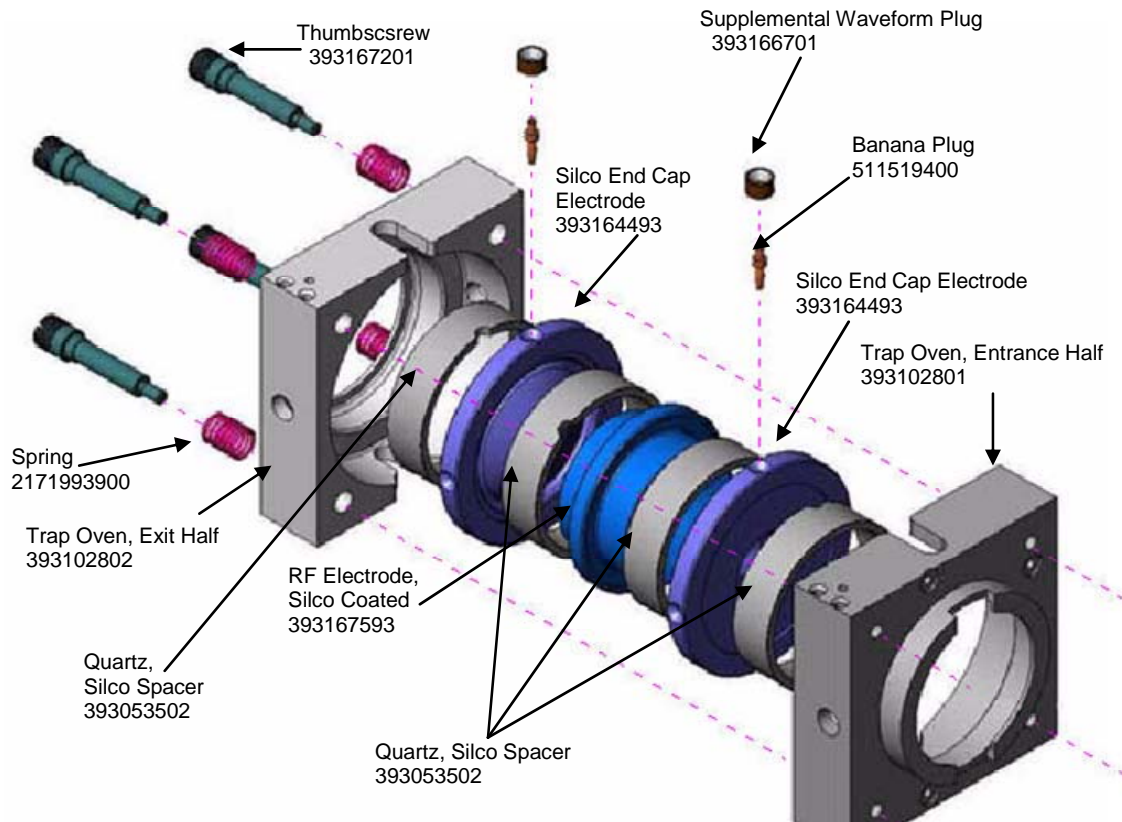

During mass analysis, a dipole voltage at the trapping RF frequency is applied across the end caps to offset the ions from the center of the trap. Two additional supplemental waveforms are applied to the end caps. The dipole signal is applied out of phase across the end caps and the quadrupole signal is applied in phase. These supplemental waveforms interact with the ions. If they correspond to one of the secondary secular frequencies of the motion of an ion, they eject the ions from the trap. The end caps receive these signals from small banana plugs inserted in the electrodes. Springs, attached to the feed-throughs in the upper flange, send the signal to the banana plugs.

A DC offset voltage can also be applied to all three electrodes in the trap. The DC offset is used in external ion mode to help introduce ions into the trap.

Detector

After ions are ejected from the trap, they are detected by the combination of a conversion dynode and an electron multiplier detector. The detector is enclosed in a cylindrical stainless steel shield that prevents metastable ions from entering the source.

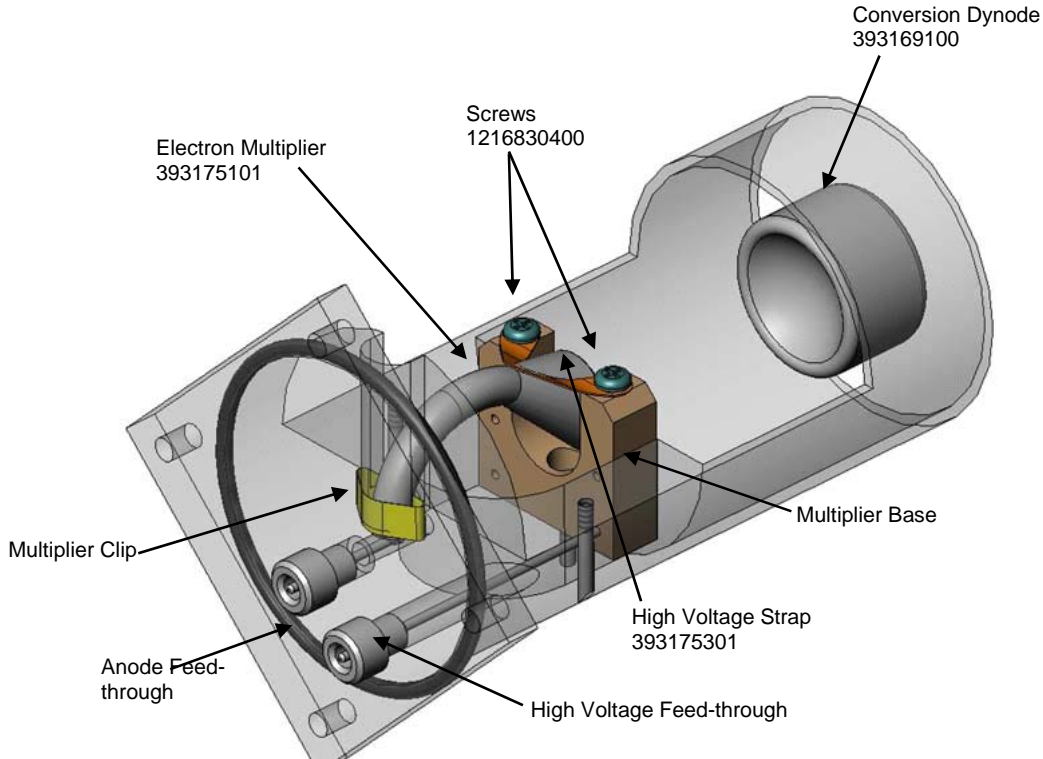

After exiting the trap, ions are accelerated onto an off-axis conversion dynode that generates a combination of positive ions and electrons through secondary electron emission. The conversion dynode is composed of a rounded stainless steel cup suspended on a post. The surface of the cup has a smooth finish that prevents spurious field emissions.

- To detect positive ions, the conversion dynode is set to a large negative voltage (typically -10 kV) and the secondary electrons are attracted to the relatively positive multiplier.
- To detect negative ions, the conversion dynode is set to a large positive voltage.

The off-axis conversion dynode eliminates detection of photons that would be detected by an on-axis detector.

The continuous-dynode electron multiplier consists of a lead-oxide/glass, funnel-like resistor. A negative voltage of between -800 and -3000V is applied to the cathode at the front of the electron multiplier. Electrons strike the cathode and cause a secondary emission of more electrons. At the end of the funnel, an anode, which held near ground potential, collects the multiplied electrons.

Electrons or ions emitted from the conversion dynode strike the cathode fast enough to dislodge additional electrons from the inner curved surface of the cathode. The increasingly positive potential gradient draws the ejected electrons into the electron multiplier and accelerates them. Because the electron multiplier is curved, the ejected electrons do not travel far before they strike the inner surface of the multiplier, and cause more electrons to be emitted. This configuration produces a cascade of electrons that is accelerated toward ground potential at the exit end of the cathode.

The anode collects the electrons and passes the ion signal to the ion amplifier mounted on the side of the vacuum manifold directly next to the multiplier. The ion current is proportional to the total number of ions that the ion trap ejects. Typically, the voltage applied to the electron multiplier is adjusted until the gain is about 10^5 , that is, until each electron or positive ion that enters the electron multiplier generates approximately 10^5 electrons.

Vacuum System

The vacuum system consists of the following: vacuum manifold, foreline pump, turbomolecular vacuum pump, ion gauge, and thermocouple gauge. A foreline pump does the initial evacuation of the vacuum manifold, in which the analyzer is located. A turbomolecular pump provides the additional vacuum to maintain the vacuum manifold at $10 \mu\text{Torr}$. A thermocouple gauge measures the foreline pressure and an ion gauge measures the vacuum manifold pressure.

Vacuum Manifold

A nickel-plated aluminum vacuum manifold contains the analyzer and has feed-throughs for electrical and pneumatic lines. A top flange provides end-cap voltages and supplies the source electrical connections from a printed circuit board feed-through. A front flange provides the chemical ionization (CI) and calibration gases and supports the CI ion source switching mechanism. A side flange provides multiplier connections. All three flanges are sealed with Viton® O-rings. Line voltage heaters in the base provide heat for bakeout. Insulating material surrounding the manifold retain the heat. The turbomolecular pump is mounted horizontally at the rear of the manifold.

Foreline Pump

The foreline pump reduces the vacuum system pressure allowing the high vacuum turbomolecular pump to operate. The foreline pump also maintains vacuum pressure by removing exhaust gas from the turbomolecular pump. The 240-MS may use the DS-102 or the IDP-3 scroll pump.

The foreline pump connects to the turbomolecular pump by a 2.1 m (84 in.) length of 1.9 cm (0.75 in.) ID vacuum tubing. The foreline pump plugs into the rear panel outlet labeled "LINE VOLTAGE - PUMP ONLY" on the rear of the MS. The outlet supplies power and the switch on the rear panel turns it on and off.

The foreline pump is a Varian DS-102 two-stage rotary vane pump, the pumping speed is 90 L/min, and the vacuum potential is 1.5×10^{-3} Torr (2×10^{-1} Pa).



**WARNING:
CHEMICAL HAZARD**

When using the 240-MS to analyze hazardous materials, direct the foreline pump exhaust to an exhaust system that complies with applicable safety regulations.

Turbomolecular Vacuum Pump

The Turbomolecular Vacuum Pump provides the high vacuum. Under normal operating conditions, this pump supplies a vacuum of approximately 10^{-5} Torr

(1.33×10^{-3} Pa) in the manifold region outside the ion trap assembly. The pump, rated at 230 liters/second, is air cooled and thermostatically protected. If the temperature of the pump housing near the bearing exceeds 60 °C, the pump automatically shuts down.

The turbomolecular pump controller regulates and supplies power to the pump. The controller sits below the pump in the analyzer compartment of the spectrometer. Turning off the main power switch on the rear panel of the mass spectrometer shuts off power to the turbomolecular pump controller and to the pump.



The electronics service switch does not turn off the vacuum pumps.

The turbomolecular pump controller monitors the rotational speed of the pump. The controller sends a signal proportional to the pump speed to the controller board through the power board. You can monitor the turbomolecular pump speed from the **Diagnostics** tab or the **Startup/Shutdown** tab in **System Control**.

If the pump speed falls below 94% of its maximum operating speed, the VACUUM OK signal turns off. The filament, electron multiplier, RF generator, CI reagent gas valve, and calibration gas valve turn off automatically. This indicates a major air leak in the system or that the pump is too warm.

Ion Gauge

The bottom of the vacuum manifold has an ion gauge, with a design based on the Bayard-Alpert gauge tube. The specifications for the gauge are similar to those of commercially available gauges. Fixed pressure readings with nominally identical gauges may exhibit variations of $\pm 15\%$. An accuracy of $\pm 25\%$ in mid-range for a gauge is typical.

While the reproducibility of the ion gauge is generally very good, the response depends on gas composition. A given pressure of air and water has a different reading than helium. The ion gauge roughly indicates vacuum conditions and is not a precise quantitative tool.

The gauge uses thoria-coated iridium (ThO-Ir) filaments. These filaments are burnout resistant, and therefore have high tolerance to air and water in the vacuum manifold. The time delay associated with heating the filament allows it to stabilize. Stable readings are obtained in 15 – 20 seconds.

The ion gauge measures pressures between 0.1 and 10,000 Torr. A logarithmic amplifier on the ion detection board amplifies the collector current, and the data system interprets this current as measured pressure.

Monitor ion gauge pressures from the **Manual Control**, **Diagnostics**, and **Startup/Shutdown** tabs in **System Control**.

Thermocouple Gauge

The thermocouple gauge measures vacuum pressure and is attached to the foreline pump hose. It is a simple, rugged, gauge that measures vacuum pressures in the range of 2 Torr (267 Pa) to 1×10^{-3} Torr (1.3×10^{-1} Pa).

Use the gauge to detect gross leaks and foreline pump failures.

Pneumatic

Pneumatic components deliver gases to the analyzer. The gases are helium damping gas, calibration gas (FC-43), and various CI reagents.

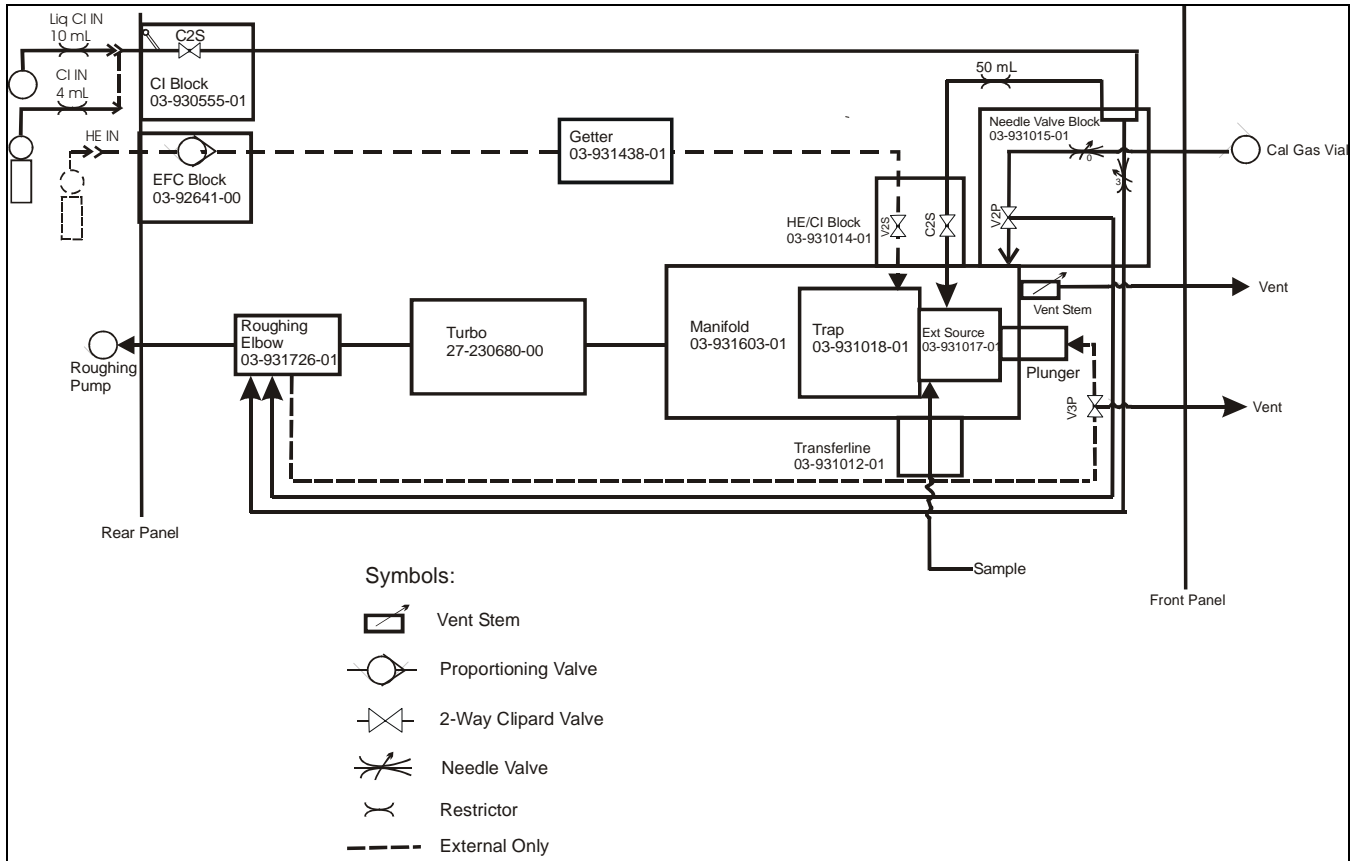

Helium Damping Gas Flow

- For internal and hybrid ionization, helium damping gas goes to the trap through the GC column flow.
- For external ionization, the helium damping gas is provided separately. Helium enters through a Swagelok® fitting in the back of the instrument. It is then immediately routed through an electronic flow controller (EFC) that maintains a constant flow.

Set the helium flow rate in **Module Attributes** in **Manual Control**. The EFC measures the pressure drop across the flow path and adjusts the position of an electronically controlled valve to keep the proper flow, see “Electronic Flow Control” on page 25. After going through the EFC, the helium flows through a heated getter to remove water and other contaminants from the system. The getter normally operates at about 400 °C.



**WARNING:
FIRE HAZARD**

Use only helium in the getter. Running air or any oxidizing gases may destroy the getter and result in hazardously high temperatures or fire.

Helium enters the vacuum manifold through a solenoid valve on the vacuum manifold side. The controller board continuously monitors the temperature of the getter. If the temperature becomes too high, due to the loss of inlet pressure or vacuum failure, the controller shuts off the helium flow on both sides of the getter.

Calibration Gas Flow

The calibration compound, perfluorotributylamine, (PFTBA), with formula $C_{12}F_{27}N$, is known as fluorocarbon-43 (FC-43). It is inside a small glass vial inside the front door of the 240-MS. A needle valve controls the flow of calibration gas and is in a block below the CI reagent needle valve inside the front door of the 240-MS. The MS Workstation controls a three-way solenoid valve downstream of the needle valve. When the Cal Gas flow is off, a vacuum is placed on the vial, through a line connected to the roughing elbow. This prevents pressure from building up and causing a pulse of calibration gas when the gas is turned on.

CI Reagent Gas Flow

The CI reagent enters the system through a solenoid valve on the instrument back. It passes through a restrictor and second solenoid valve, on the same block, on the same side of the manifold as the helium solenoid valve. A line to the roughing elbow is attached to the CI line to pump away some of the reagent. This prevents pressure pulses when the CI is turned on. The CI control needle valve controls the flow in this vacuum line that in turn controls the flow of reagent into the source by changing the split ratio. After passing through the solenoid valve, the flow passes through the magnet structure inside the vacuum manifold. For Internal Chemical Ionization, the reagent flows into the entire manifold. For External Chemical ionization, the reagent goes into the CI source volume.

Electronics



**WARNING:
SHOCK HAZARD**

HIGH VOLTAGES INSIDE. No user serviceable parts under screw-attached covers. Contact your local Varian, Inc., service representative for instrument repair and service.

The electrical functions of the 240-MS are distributed among eight boards (see block diagram). The boards are located as close as possible to the associated part of the spectrometer. The RF coil plays a part in generating the trapping field RF and is a power entry subsystem in the back of the instrument.

The functions of the boards are as follows:

- Controller Board: controls spectrometer operations and acquires data generated by the system.
- Power Board: generates all power sources for the instrument, controls the temperature of heated zones, routes signals between other boards, and drives all solenoid valves.
- Lower Manifold Board: drives various source voltages and controls filament operation.
- Upper Manifold Board: contains circuitry that handles supplemental excitation waveforms and trapping field dipole switching.
- RF Generator Assembly: generates and controls the RF trapping field.
- Ion Detector Board: detects ion through the multiplier and ion gauge both of which detect ions in the system.
- Ion Amplifier: amplifies the ion signal.
- Electronic Flow Controller: controls the flow of the helium damping gas.

A power input sub-system distributes line voltage to various components as needed.

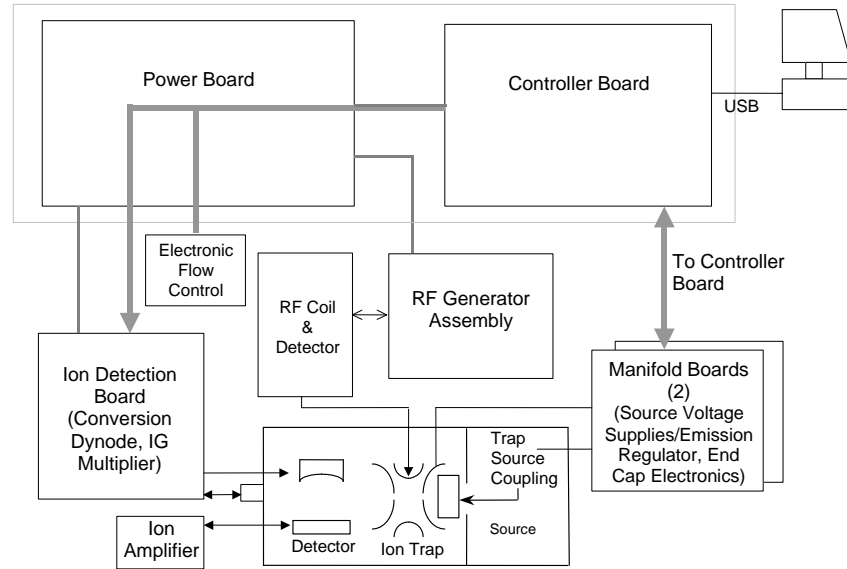

Controller

The controller does the following:

- Controls operations and acquires data.
- Executes scan functions.
- Sets various static voltages.
- Switches components such as valves.

Commands and data are communicated between the controller and the MS Workstation computer through a universal serial bus (USB) interface.

The processing subsystem uses two TI DSP (Digital Signal Processing) microchips. They allow time critical operations, handled by the scan processor, to be separated from non-time critical operations, handled by the communication processor. Each processor has a local memory containing programs, and a shared dual processor memory that holds data and exchanges command or status information. The scan processor handles instrument control, including scan function execution and data acquisition, in a synchronous manner. The communications processor receives commands from the workstation and transmits accumulated data asynchronously.

Entire acquisition method segments are downloaded to the communications processor before being executed and stored in shared memory. The segments are activated at the appropriate time by the controller. Multiple method segments can be preloaded. 32 MB of dynamic random access memory (DRAM) stores a library of waveforms for scan function supplemental waveforms. The combination of preloaded waveform libraries and preloaded segments eliminates delays between segments.

Latches control switching components, such as solenoid valves. The scan processor sets analog control voltages through a set of digital to analog converters. They range in resolution from 10 bits for lens voltages to 16 bits for the trapping field RF level.

Field programmable gate arrays, FPGAs, are used with the acquisition controller, waveform/memory controller, and RF scanner.

Power Board

The power board supplies power to all electronic components except the turbomolecular pump controller. It controls heaters and solenoid valves and provides signal routing between the controller board and system boards.

NOTE: The switching power supply is protected by a 5A, non-time delay fuse.

Switching power supplies provide all voltages. The following switching power supplies reside on the board:

- A +5V dc power supply provides voltages to all digital circuits.
- The -15V and +15V dc power supplies provide voltages to the analog circuits on the power board and the manifold electronics assembly.
- The +20V and -20V dc power supplies provide the voltages to the controller and the analog circuitry of the RF generator board.
- A +24V dc power supply provides power for the solenoid valves, heaters, the EFC, electronics compartment fan, and the electron multiplier power supply.
- A +60V dc power supply provides unregulated +55V dc voltage to the RF generator board.
- The 200 volt power supply provides voltages to various lens circuits and gate circuits as well as the ion gauge.

The following circuits are on the board:

- Four heater control circuits provide feedback control for the manifold, trap, external source, and transfer line heaters. The trap heaters use proportional integral (PI) control circuits.
- Four solenoid control circuits turn the calibration gas, CI reagent gas, CI shutoff valve, and EI/CI volume solenoids on and off.
- The diagnostic multiplexer circuit routes the voltage output of various components, and circuits on the power control board to the controller board. Access these voltage outputs through the diagnostic pages.

On the top edge of the power board are 15 monitor LEDs. When the green LEDs are on, they indicate that the voltages of the various circuits on the power board are at the proper levels, and that there are no faults.

The power board supplies most of the regulated voltages for other electronic subsystems in the spectrometer. The voltages include +5 volts for digital components, ± 15 volts for analog components (such as amplifiers), +24 volts for all heaters except the manifold, and 60 volts for the trapping field RF generator.

Manifold Electronics

The manifold electronics are two stacked boards in an enclosure on top of the vacuum manifold. They are involved in the ionization and mass scanning processes.

- External source functions include providing lens voltages and heater control.
- External and Internal ionization functions include providing filament control for both modes.

The upper manifold board conducts the signals dipole waveforms and quadrupole waveforms applied to the ion trap end cap electrodes.

- Dipole waveforms are applied to the end caps during ionization, isolation, and mass scanning. The dipole signal is applied, out of phase, to the two end caps to provide a signal across the end caps.
- Quadrupole waveforms are applied during mass scanning. The quadrupole signal is applied in phase to provide a voltage between the end caps and the ring electrode.

The controller board sends the waveform signals through the power board. High-power operational amplifiers buffer the signals applied to the end caps through transformers that step up the waveform voltage.

Dipole waveforms are applied by two transformers. One is for high frequency dipole waveforms, and the other is for low frequency square waves applied during non-resonant CID. A trapping field dipole (TFD) voltage applied during the mass scanning process offsets the trapped ions from the center of the trap. The TFD signal, derived from trapping field RF currents, flows in the end caps coupled from the 1 MHz signal applied to the ring electrode by the RF generator and coil. Changing the impedance between end caps and ground switches the TFD on and off. When the TFD is off, low impedance is applied. When the TFD is turned on, high capacitive impedance is applied to one end cap and inductance impedance is applied to the other resulting in the out of phase dipole signal.

The lower manifold board has source related electronics functions such as:

- Amplifiers that apply the appropriate lens voltages to the source, based on set points received from the controller board.
- Regulating circuit for the source filament emission.
- Conditioning electronics that produce high-level temperature measurement signals from resistive temperature devices (RTDs) provide temperature control and a diagnostic tool.

RF Generator Assembly

The RF generator assembly consists of an RF generator circuit board, an RF detector circuit board, and the RF coil. A shielded housing beneath the vacuum manifold encloses the coil and RF detector circuit board. The RF generator circuit board is attached to the back of the shielded housing.

The RF generator circuit board receives an analog signal from the controller board that is proportional to the current mass position in the scan, which is in turn proportional to the desired RF voltage applied to the ion trap. The RF detector circuit board sends a signal proportional to the actual amount of RF voltage applied to the ion trap to the RF generator board. The RF generator board compares the desired and actual amount of the RF voltage and adjusts the gain of an amplifier so the RF voltage equals the desired RF voltage. Since the ion trap requires high voltages that exceed the capabilities of conventional electronic amplifiers, a resonant LC circuit consisting of the RF coil and the ion trap capacitance generates them. At resonance, the RF voltage at the ion trap end of the coil is about 150 times greater than that at the RF generator circuit end of the coil.

Ion Detection Board

The ion detection board has the electronics the electron multiplier or the ion gauge use to detect ions. The power supply applies voltage to the cathode of the electron multiplier. A signal from the controller switches the voltage of the power supply, a chain of voltage multiplier circuits, from -800 to -3000 volts. Also on the ion detection board are the emission current regulation circuitry for the ion gauge, and the electronics that take and condition the vacuum signal for it.

Ion Amplifier

The ion amplifier converts the current received from the electron multiplier to a voltage for the controller board analog to digital converter and boosts the signal by a factor of 10^7 . To maximize the bandwidth, the amplifier is mounted on the side of the vacuum manifold close to the multiple output feed-through.

Electronic Flow Control

An electronic flow controller (EFC) controls the flow rate of helium damping gas for external ionization. A closed loop feedback control system maintains the proper flow. A digital-to-analog converter (DAC) sets the flow rate set point and the controller board sends the DAC the setting. The control electronics reads the flow by measuring the pressure across a known orifice using two pressure transducers. A proportional solenoid valve sets the flow. The factory calibrates the relationship between flow and differential pressure. The ambient temperature is measured to compensate for flow differences due to temperature. The EFC also controls the helium cutoff valve at the manifold. The valve is closed if excess getter temperature is detected or if the helium inlet pressure drops below 20 psi.

Power Input Subsystem

The power input subsystem contains the following:

- Main power switch
- Service switch
- Line voltage switches

Main Power Circuit

Line power of 90 - 130 VAC, 60 Hz \pm 3 Hz (or 180 - 230V ac, 50 Hz \pm 3 Hz) enters the rear panel of the MS through J1, and then passes through a line filter and the circuit breaker. After the circuit breaker, the power is split in two directions.

- The first path supplies the turbomolecular pump controller and foreline pump via J2. The turbomolecular pump controller provides startup power to the power board, and regulates the speed of the turbo pump.
- The second path goes to the electronics service switch, which controls power going to the power board and the rest of the electronics. The electronics service switch allows the vacuum to be maintained when the electronics are serviced.



**WARNING:
SHOCK HAZARD**

In the event of an emergency, shut off all power.



WARNING

If the equipment is used in a manner not specified in this manual, the protection provided by the equipment may be impaired.

Rotary Vane Pump Maintenance

Maintenance Schedule

Refer to the Quick Reference for a schedule of maintenance tasks.

Checking Oil Level and Condition

NOTE: Pump models are subject to change. If not using a model DS-102 pump, see the pump manual for details.

While it is best to check the level and condition of the pump oil with the pump switched off and warm, you can make good estimation with the pump running. The oil level should be between the maximum and minimum levels on the sight glass. If the oil level falls below the minimum level, use a funnel to add more oil, part number 8829951700, gradually through the filler port until the oil level is centered between the maximum and minimum levels.

Changing Foreline Pump Oil

NOTE: These instructions are for the DS-102 only. The scroll pump does not use oil.

To ensure peak performance and maximum pump lifetime, change the pump oil whenever the oil becomes thick, dark in color, and has a burnt smell, or at least once a year. Change the oil change while it is warm but not immediately after stopping the pump.

Materials Needed

- 5/16 in. Allen Wrench
- Foreline Pump Oil, part number 8829951700
- 1.0-liter (1 US qt) or larger container for used oil

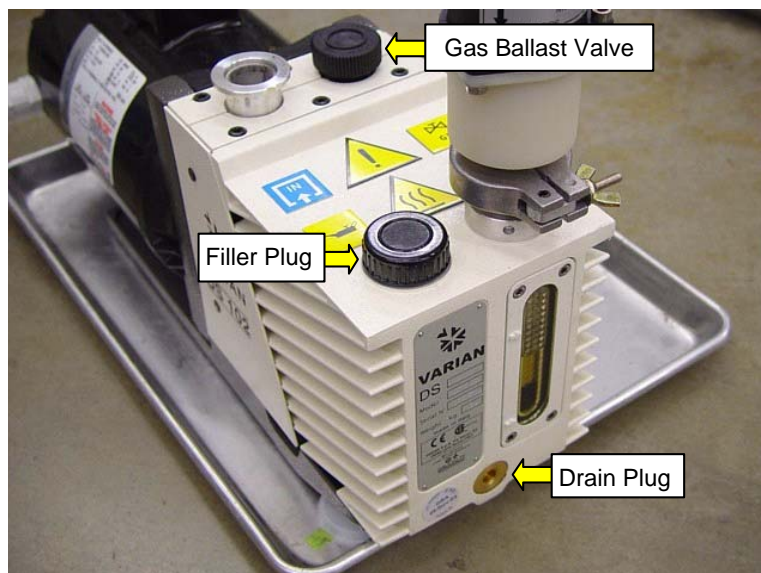

Setting Up for the Oil Change

1. Turn off and vent the MS, use the “Turning Off the MS” procedure on page 38.



**WARNING:
SHOCK HAZARD**

Dangerous high voltages are present. Unplug power cord.

2. Disconnect the power cord of the pump from the rear of the MS.



**WARNING:
BURN HAZARD**

Hot surface. Take appropriate precautions. Wait for the pump to be cool enough to touch before continuing the oil change.

3. Disconnect the vacuum hose from the foreline pump by removing the clamping ring.
4. Pull the hose free, and place the seal on a clean low-lint surface.
5. Carefully place the foreline pump on a raised surface. The surface must be high enough to allow a 1.0-liter (1 US qt) or larger container to go under the drain port to catch the old oil. Use a container with an opening diameter of at least six inches.
6. Place an oil pan beneath the drain port to catch spills.



CAUTION

The pump weighs at least 22 kg (48 lb.). Use proper lifting techniques to avoid physical injuries.



**WARNING:
CHEMICAL HAZARD**

Hazardous chemicals may be present in the used pump oil. Avoid contact with skin.



**WARNING:
EYE HAZARD**

Use proper eye and skin protection.

Changing the Oil

1. Remove the filler plug from the top of the pump.
2. With the container in place to catch the oil, slowly remove the drain plug from the pump using a 5/16 in. Allen wrench.



**WARNING:
CHEMICAL HAZARD**

Toxic residues from MS samples will build up in used pump oil. Dispose of all used pump oil in accordance with applicable regulations. Place a hazardous chemical warning label on the container.

3. Tilt the pump forward until the oil stops flowing.
4. Set the pump back down and refit the plug.
5. Run the pump for about ten seconds with the intake port open. This removes residual oil from the pumping block.



CAUTION

Avoid breathing oil mist coming from the exhaust port during this operation.

6. Remove the plug, tilt the pump, and drain remaining oil.
7. Set the pump back down.
8. Wipe the oil residue from the drainage port, and refit the drain plug.
9. If the pump oil was particularly dirty, flush the pump using the “Flushing the Pump Oil” procedure on page 29.
10. Fill the pump with new oil, part number 8829951700, through the filler port until the oil level reaches the maximum level in the sight glass.
11. Replace the filler plug.
12. Replace the oil mist cartridge.

Flushing the Pump Oil

After you drain the oil out of the pump, (as described previously in steps 1 – 14), if the oil is extremely dirty, flush the pump oil out of the pump.

To flush the pump oil:



Avoid breathing oil mist coming from the exhaust port during this operation.

1. Pour 330 mL (0.35 US qt) of fresh pump oil in through the inlet port then run the pump.
2. Stop the pump, drain the oil the pump was flushed with, and then continue filling with fresh oil.
3. Change the oil mist cartridge.

Changing the Oil Mist Cartridge

Replace the cartridge of the oil mist eliminator on the exhaust port of the pump when the oil is changed. The part number for a package two of cartridges is 2710100200.

NOTE: When the cartridge is saturated, excessive mist or oil sprays out, and the cartridge must be replaced.

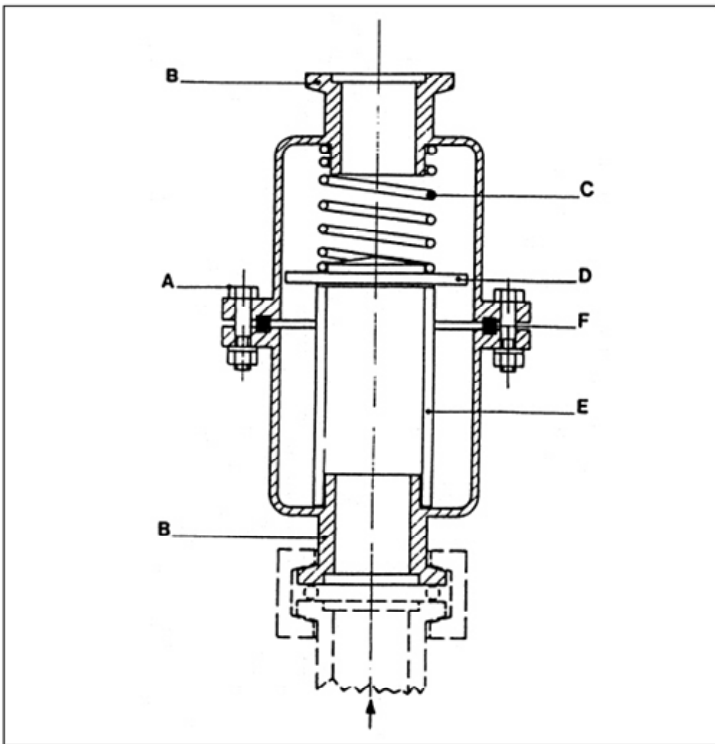

To disassemble the oil mist eliminator:

1. Remove assembly screws **A**.
2. Remove upper housing **B**.
3. Remove spring **C**.
4. Remove valve **D**.
5. Remove cartridge **E**.
6. Remove O-ring **F**.
7. Clean the parts with a dry tissue.
8. Degrease with a water soap solution.
9. Rinse with clean water and dry.

To reassemble the oil mist eliminator:

1. Install a new cartridge in lower housing **B**.
2. Press gently to ensure it is connected.
3. Install valve **D** with polished side toward cartridge.
4. Center spring **C** over the valve.
5. Fit gasket **F** in the groove.
6. Cover the entire assembly with the second casing **B**.
7. Tighten the two casings **B**, using screws **A**.

Checking the Cooling Fans



To prevent overheating, do not block air intakes.

The MS has two fans on the rear panel, which maintain an optimal temperature for the turbomolecular pump and electronics. Without them, the lifetime of the turbomolecular pump and temperature-sensitive PC-board components can decrease. To ensure proper operation of the cooling system, operate the MS with its covers in place. Check the fans at least once a week.

To check the fans:

1. Make sure that the main power switch and service switch are turned ON.
2. Place a large sheet of paper over one of the fan guards.
 - If the paper is sucked toward the fan guard, the fan is working.
 - If the paper is not sucked toward the fan guard, the fan is broken. Contact your Varian Customer Support Representative to arrange for a replacement.
3. Replace the fan if it whines or whirs because it may fail.
4. Check the second fan in the same manner.

Dry Scroll Pump Routine Maintenance

Maintenance Schedule

Refer to the Quick Reference for a schedule of maintenance tasks.

Purging the Pump

Once every three months, run the pump at atmosphere for a minute or two to flush it.

Replacing the Tip Seals

The following parts and tools are required to replace tip seals:

- Tip Seal Replacement Kit, part number, IDP3TS, containing Replacement Tip Seals and O-rings.
- 4 mm Allen wrench.
- Razor blade or small craft knife.
- Compressed air, optional.
- Torque wrench, 5.6 N*m (50 lb*in.) with a 4 mm hex driver.



CAUTION

If dangerous gases were pumped, flush the pump with air or inert gas for at least 10 minutes before disassembling it.

Removing Worn Tip Seals

1. Disconnect the pump from electrical power.
2. Remove the 4 M5 socket head bolts, (item 1).
3. Remove the front cowling (item 2), disconnect the electrical connector, and set the cowling aside.
4. Remove the 4 M5 bolts (item 4).
5. Remove the outboard housing axially off the frame (item 5).
6. Remove and discard the worn tip seals (item 6).
7. Remove and discard the main O-ring (item 7).

8. If compressed air is available, blow off any remaining seal debris. If seal debris is attached to the sides, use a razor blade or a small craft knife to scrape off the debris.

Installing New Seals and O-ring

1. Unpack the tip seals for the orbiting scroll and the outboard housing scroll.
2. Install the correct tip seal into the groove of the orbiting scroll by doing the following:
 - a. Insert the seal with the foam backing in the groove; the white plastic surface must face up.
 - b. Starting from the center, press the seal into the groove and work outward.
 - c. Cut off the excess tip seal that extends, about 3 mm (1/8 in.) from the outer edge of the groove.
3. Install the correct tip seal into the groove of the outboard housing scroll by following the instructions for the orbiting tip seals, step 2.
4. Ensure that the groove of the frame is clean and then place the new main O-ring into the groove on the frame.
5. Ensure that the sealing face of the outboard housing is clean. Carefully replace the outboard housing by lining up the locating pins. Ensure that the tip seal is in the groove.
6. Reinstall the 4 M5 bolts, item 4, and torque them to 5.6 N*m (50lb*in.).
7. Reconnect the electrical connector at the front cowling.
8. Replace the front cowling and secure it with the M5 bolts.
9. Plug in the pump.

Testing the Pump

1. Run the pump for 5 seconds. Ensure that the front fan is working. If you hear loud noises or observe labored operation, the tip seal or main O-ring may be out of place.
2. Disassemble the pump and repair as necessary.

NOTE: Newly installed tip seals may require several hours of run time to enable the pump to meet speed and base pressure specifications.

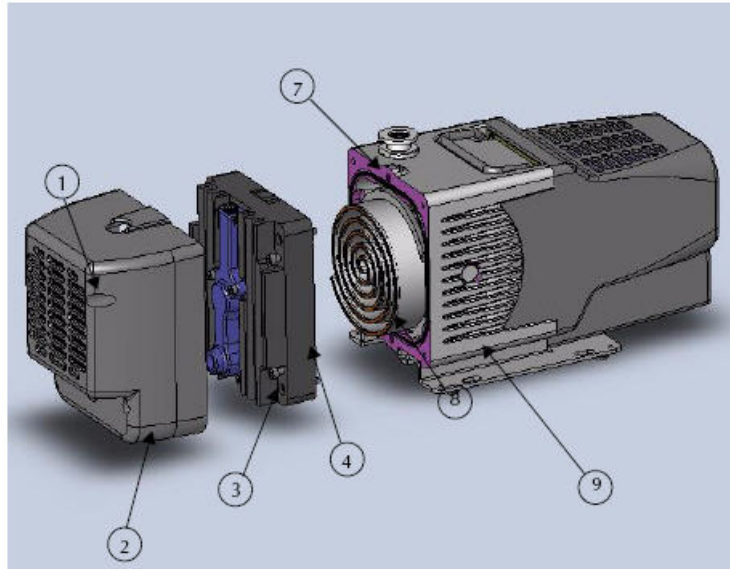

Part of the IDP-3 Dry Scroll Vacuum Pump	
1. Front Cowling Bolts, M5, 4 each	6. Main O-ring Parker Number 2-160 (not shown)
2. Front Cowling	7. Locating Pins, 2 each
3. Frame Bolts, M5, 4 each	8. Orbiting Scroll
4. Outboard Housing	9. Frame.
5. Tip Seals, not shown	

MS Maintenance Procedures

General Recommendations

- Be careful not to introduce contaminants in the system.
- Wash your hands before working on the system. Avoid hand creams and highly perfumed soaps.
- Wear powder-free nitrile gloves when handling internal parts. Other glove types can leave chemical residue. If these are not available, use lint-free cotton or lint-free nylon gloves. Do not wear nylon or nitrile gloves when handling very hot parts.
- Keep all tools clean and free of grease or other contaminants.
- Store sources and transfer line tips in the provided contaminant-free containers.
- Use clean and filtered compressed air and low-lint wipes to eliminate particles inside the vacuum manifold and on sealing surfaces.
- Cover open manifolds or exposed parts while not working on them with chemical wipes or aluminum foil.

Tools and Materials

The following tools and materials are required for MS maintenance.

- Tweezers or long nose pliers
- Longneck Phillips head screwdriver
- Longneck flat head screwdriver
- 3/16 in. wrench (or transfer line tool provided)
- 5/16 in. wrench
- 1.5 mm Allen wrench
- Toothbrush
- Beakers
- Sonicator
- Craft knife (such as an X-acto® knife)
- Pasteur pipettes
- Gloves: powder-free Nitrile, lint-free cotton, or lint-free nylon
- Chemical wipes such as Kimwipes®
- De-ionized water

- Isopropyl alcohol, methanol, or methylene chloride
- Acetone
- Mild detergent (pH 6 to 7.5)
- Aluminum oxide
- Cotton swabs
- Sandpaper

Common Procedures

These procedures are followed for most of the maintenance procedures. Other procedures in this manual reference them.

Turning Off the MS



**WARNING:
BURN HAZARD**

Let heated areas cool before disassembling.

1. Click **Shut Down** in the upper left corner of the **Startup/Shutdown** tab in **System Control**. The heaters turn off and the speed of the turbo pump gradually reduces to 35% of full speed. It may take several hours for full shutdown and cooling to take place.

Manual Control	Auto Tune	Temperatures	Diagnostics	Startup/Shutdown	Acquisition			
<table border="1"> <tr> <td> Status and Control Conditions: Analysis Shut Down State: Ready Vacuum System Status: Ready </td> <td> Current Set Points Heated Zones Trap Temperature: 220 C Manifold Temperature: 50 C Transferline Temperature: 280 C Vacuum System Pump Spin Speed: 100 % </td> <td> Operating Conditions Heated Zones Trap Temperature: 220 C Manifold Temperature: 49 C Transferline Temperature: 280 C Vacuum System Pump Spin Speed: 100 % Current: 199 mAmps </td> </tr> </table>						Status and Control Conditions: Analysis Shut Down State: Ready Vacuum System Status: Ready	Current Set Points Heated Zones Trap Temperature: 220 C Manifold Temperature: 50 C Transferline Temperature: 280 C Vacuum System Pump Spin Speed: 100 %	Operating Conditions Heated Zones Trap Temperature: 220 C Manifold Temperature: 49 C Transferline Temperature: 280 C Vacuum System Pump Spin Speed: 100 % Current: 199 mAmps
Status and Control Conditions: Analysis Shut Down State: Ready Vacuum System Status: Ready	Current Set Points Heated Zones Trap Temperature: 220 C Manifold Temperature: 50 C Transferline Temperature: 280 C Vacuum System Pump Spin Speed: 100 %	Operating Conditions Heated Zones Trap Temperature: 220 C Manifold Temperature: 49 C Transferline Temperature: 280 C Vacuum System Pump Spin Speed: 100 % Current: 199 mAmps						

2. To speed up the shutdown process, power down the system and purge with nitrogen. See “Using Nitrogen Purge” page 40.
3. After shutdown is completed, as indicated in the shutdown log window, exit **System Control**.

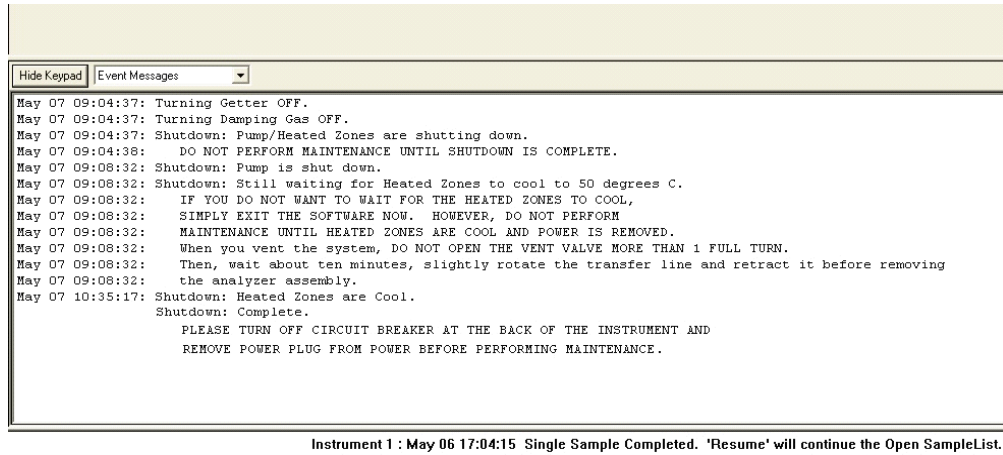

4. Turn off the main power switch on the back panel to shut off the turbomolecular pump, foreline pump, and all electronics.
5. Unplug the 240-MS power cord.
6. Open the front panel door and lift the vent lever.



**WARNING:
BURN HAZARD**

The Vent Lever, CI Plunger, and surrounding area may be extremely hot.



7. Listen to the turbomolecular pump spin down and wait until it has completely stopped. Leave the vent open for about 10 minutes to allow the pressure to equilibrate.
8. Close the vent by pressing the lever.

Using Nitrogen Purge

Purging the vacuum manifold with nitrogen after the trap has partially cooled reduces the shutdown time.

To turn off the MS using nitrogen purge:



**WARNING:
BURN HAZARD**

Allow heated zones to cool before disassembling.

1. Shut down the MS using the **Status and Control** section of the **Startup/Shutdown** tab in **System Control**.
2. Click **Shut Down** in the upper left corner of the screen. The heaters are turned off and the speed of the turbo pump gradually reduces to 35% of full speed. It may take several hours for full shutdown and cooling to take place.

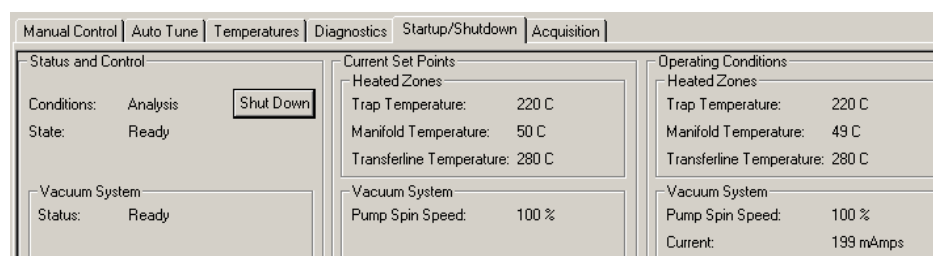

3. Open the front door and attach a source of nitrogen at 5 psi or less through a polyurethane tube to the barbed fitting on top of the vent lever.

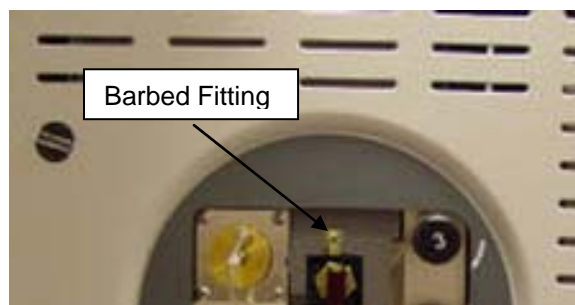

4. After the speed of the pump falls to 35% and the trap temperature reaches 150 °C, exit **System Control**.
5. Turn off the main power switch on the back panel, to shut off the turbomolecular pump, foreline pump, and all electronics.
6. Disconnect the 240-MS power cord.



**WARNING:
SHOCK HAZARD**

Dangerous high voltages are present. Unplug power cord.

7. Open the vent valve by lifting the vent lever with the Nitrogen flow on.
8. Listen for the turbomolecular pump to stop and wait one hour for the trap to cool down.

9. Close the vent by pushing the lever in.
10. Remove the nitrogen line.

Moving MS Away from GC

1. Turn off the GC column oven and heater. On the 450-GC keypad, press the **Column Oven** button and the blue soft key **Turn Oven Off**.



**WARNING:
SHOCK HAZARD**

Dangerous high voltages are present. Unplug power cord.

2. Open the GC oven door. Ensure that about 30 cm (12 in.) of the end of the capillary column in the MS is hanging freely and that the column is not caught on the column rack or cage.
3. Ensure that the pneumatics tubing at the back of the instrument is long enough to move the spectrometer.
4. While watching the capillary column in the GC oven, gently slide the MS away from the GC with the transfer line lined up with the GC hole. As you slide the MS, do not allow the column to bind or kink. Move the MS about 23 cm (9 in.) from the GC. The transfer line should be out of the GC oven.

Removing the Analyzer Assembly

To remove the Analyzer Assembly:

1. Perform the “Moving MS Away from GC” procedure on page 41.
2. Remove the top cover from the MS.



**WARNING:
SHOCK HAZARD**

Dangerous voltages exposed when cover is removed. Unplug power cord.



3. Let the transfer line cool before you retract it by turning counterclockwise while it pulling out. Use a little force, if necessary, to release the residual vacuum.

- If the transfer line does not come out, open the vent again, to ensure the analyzer is at atmospheric pressure.
- If the transfer line is still difficult to retract, use the transfer line tool or a 3/16 in. wrench to twist the end of the transfer line counterclockwise while retracting it.



4. After retracting the transfer line, lock it into position by turning it clockwise.

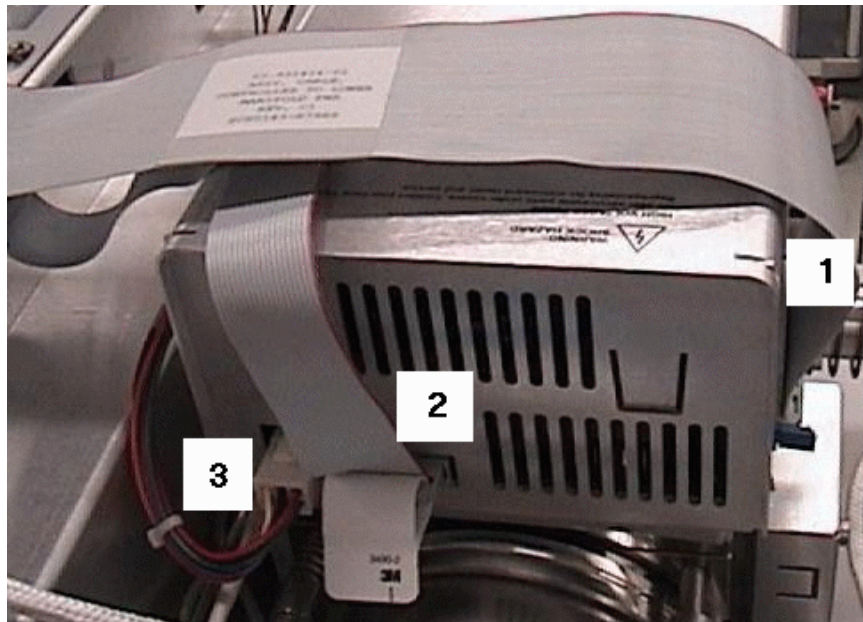

5. Press the release tabs out to remove the controller to manifold cable (1).
6. Pull the white pull tab to remove the manifold lens cable (2).
7. Press the locking connector down and pull it out to remove the manifold power cable (3).



Verify that the transfer line is fully retracted and locked into position to prevent damaging the tip.

8. Lift the analyzer assembly up and out of the manifold and place it upside down on the work area.
9. Cover the manifold opening with a Kimwipe® or other low-lint material to avoid dust or other particulates from contaminating the instrument.
10. Since the manifold cover is off, use clean tools and wear powder-free gloves for subsequent procedures.

Removing the Source and Ion Trap Assembly

1. With your thumb and forefinger, gently wiggle each connector to detach it from the external source or internal ionization assembly. At the same time, pull the connector off the pins. If in internal ionization, keep the internal source filament adaptor attached to the flex cable. If necessary, use tweezers or pliers to remove the connector.

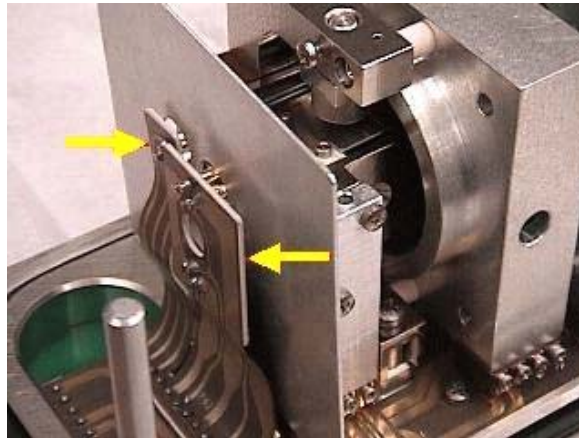

2. Loosen the two screws holding the heat shield and slide it away from the source or remove it.

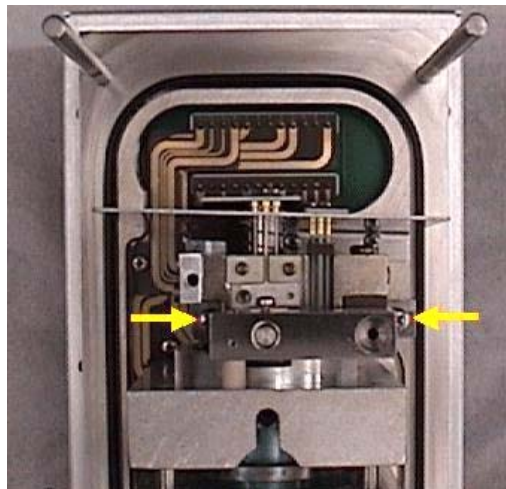

3. Loosen the two screws attaching the trap assembly to the top flange.
4. Lift the assembly out and place the assembly on the holder provided (if servicing the ion trap) or on a low-lint tissue with the source facing up.

NOTE: Do not rest the assembly on the heater connectors or source pins.

Reinstalling the Source and Ion Trap Assembly

To reinstall the Source and Ion Trap Assembly

1. Ensure all the connection fingers are even. If any fingers are bent substantially, bend them back in line with the others.

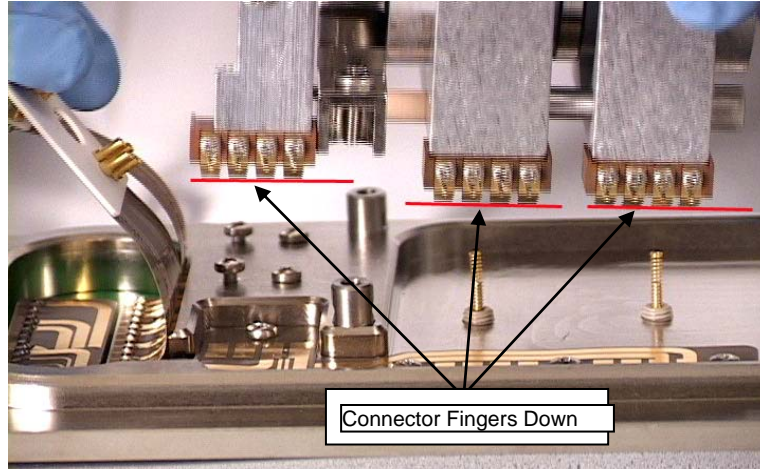

2. Put the Source/Ion Trap assembly on the analyzer flange with the connector fingers down.
3. Align the two screw holes on the flange with the screws on the Source/Ion Trap assembly and evenly tighten the two screws.

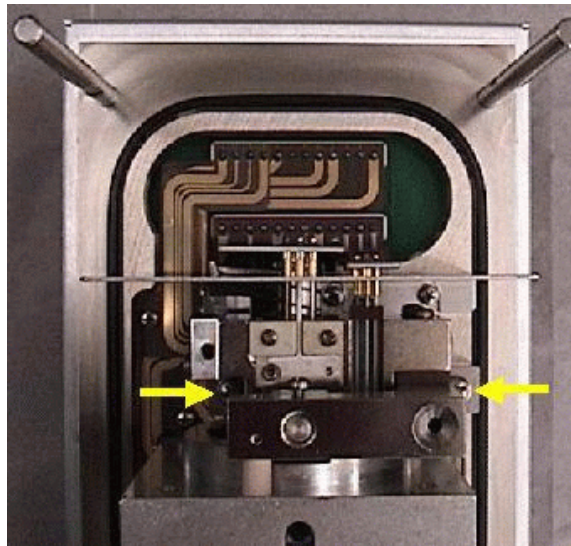

4. Replace the heat shield and tighten the two screws securing it to the flange.
- External ionization: The shield must be on the rear set of screws. The shield should be on top of the ridge on the source heater block, as shown.
 - Internal ionization: The screws are closer to the center part of the source. Ensure the two screws in the alternate shield position are also tightened down.

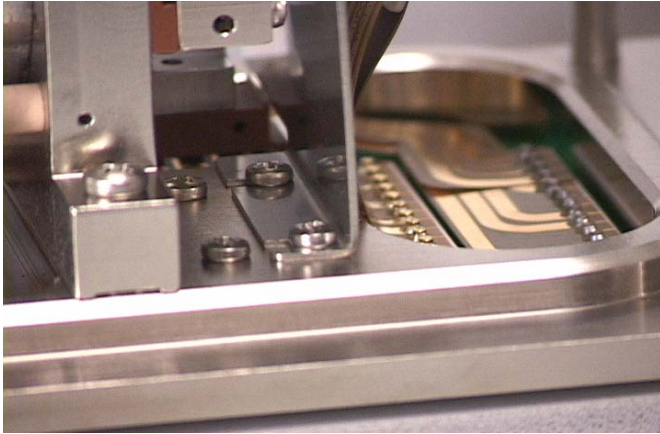

Heat Shield Position with External Ionization

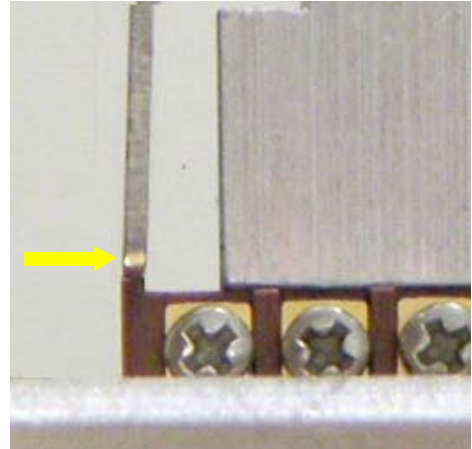

Shield - Heater Block Alignment

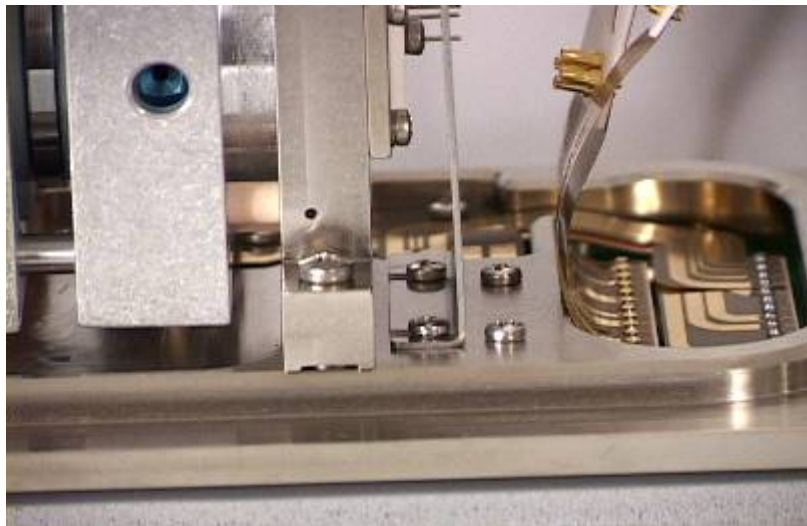

Heat Shield Position with Internal Ionization Source

5. Straighten pins that are not in alignment.

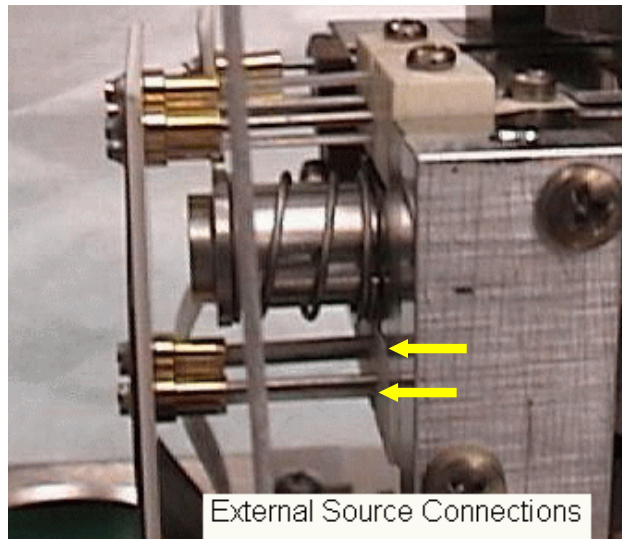

6. Push the connectors onto the source pins. Each pin must be correctly aligned. If a pin is bent, use a pair of tweezers to align it.

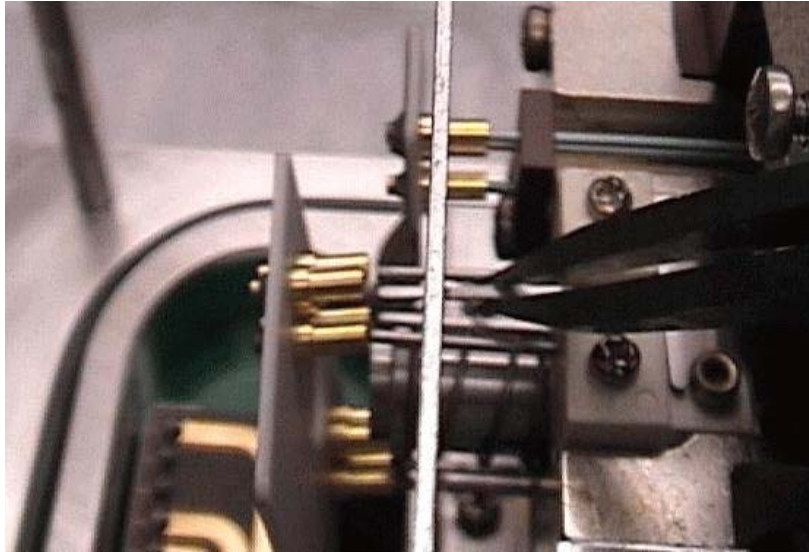

Reinstalling the Analyzer Assembly

1. Before installing the analyzer, check for particles inside the manifold or on the analyzer assembly. If necessary, blow the particles out using clean and filtered compressed inert gas.
2. Inspect the upper flange O-ring for particles and clean if needed.



3. Ensure the three tubes protruding from the bottom of the manifold are straight. Replace any tube that is bent more than 20 degrees or damaged.



4. Ensure the transfer line is away from the analyzer. The analyzer assembly has four metal pins that must align with the four holes in the manifold.
5. Align these pins and slide the analyzer into the manifold. Ensure that the wire harnesses and pneumatic lines, between the manifold and bulkhead, are not crimped as you install the analyzer.
6. Reconnect the following cables from the analyzer:
 - The controller to manifold cable (1).
 - The manifold lens cable (2).
 - The manifold power cable (3).

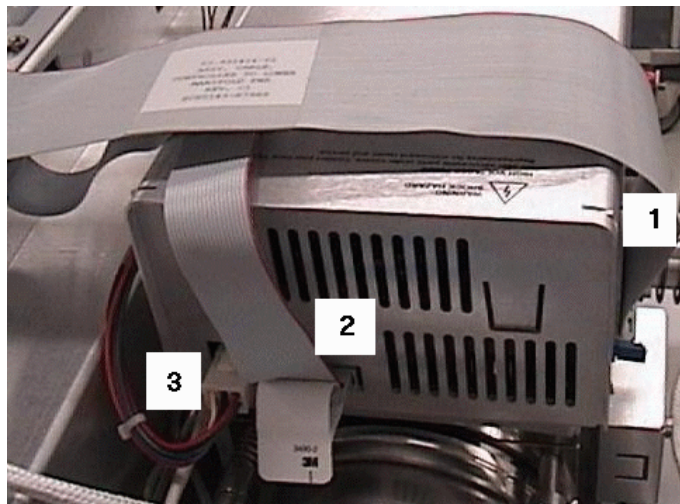

7. To avoid damaging the transfer line assembly, gently push it towards the manifold while checking that it slides all the way into the manifold. If the transfer line stops, remove the analyzer and check the tip on the transfer line. If it is bent, straighten, or replace it. For external mode, be sure the hybrid mode plug is not in place.
8. Turn it clockwise to lock it into place.



Turning On the MS

1. Ensure the vent in front of the MS is closed (turned clockwise completely).



2. Ensure that all the cables are plugged in.
3. Ensure that the column from the GC is installed properly, the transfer line is locked in its operating position, and the GC is operating.
4. Plug the MS power cable into the rear of the instrument.
5. Turn the power switch on the rear panel to the ON position. The foreline pump should turn on and then stop gurgling after about 10 to 20 seconds. If the pump continues to gurgle, ensure the analyzer assembly is seated on the manifold properly, (there should be no gaps).

6. Open **System Control**.

7. Click the **Startup/Shutdown** tab in **System Control**.

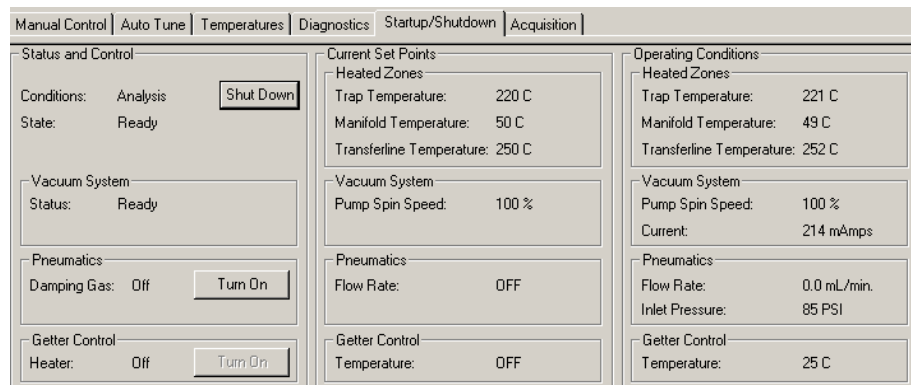

8. Perform “Checking the Vacuum Status” on page 50.

9. If you are using external or hybrid mode, turn on the damping gas and getter heater using the buttons in the lower left of the startup/shutdown tab.

10. Perform “Baking Out the MS” on page 51.

11. Perform “Checking Ion Trap Operation” on page 51.

Checking the Vacuum Status

To check the vacuum status:

1. Click the Diagnostics tab in System Control.

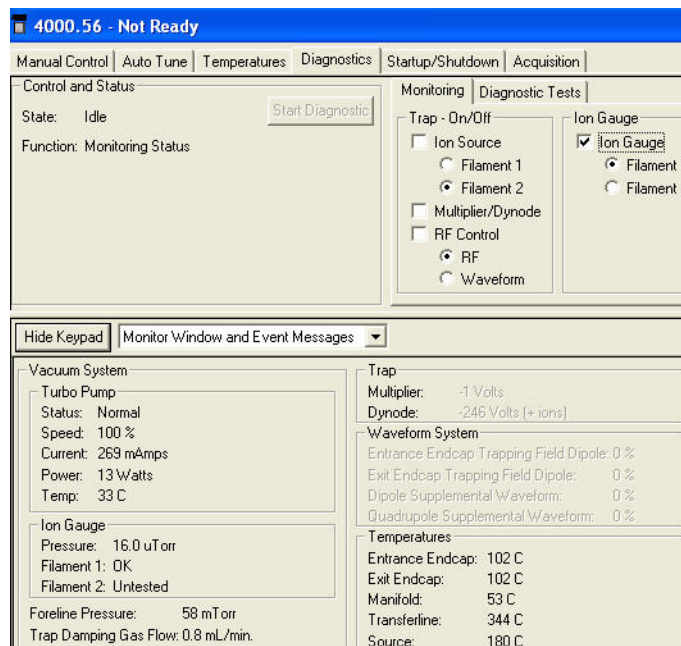

2. The vacuum readings, lower left, provide information about the state of the MS after pump down and during operation.

Typical operating ranges for internal ionization are:

Speed	100%
Current	200 – 300 mA
Power	9 – 13 Watts
Ion Gauge Pressure	< 20 μ Torr
Foreline Line	< 50 mTorr

3. If the Pump Spin Speed does not steadily increase, there may be a leak. If the turbo speed is less than 100%, there may be a large leak. After 100% of the turbo speed is reached, an increase in the pump current or in the ion gauge pressure, may indicate a small leak (See **Diagnostics Mode** section in the 240-MS GC/MS Operation Manual, part number 391499900.) Locate small leaks using the leak check section in the internal or external service method. For more details, see “Checking for Leaks” on page 102.

Baking Out the MS

After venting the system, bake it out to eliminate water and contaminants in the vacuum manifold.



WARNING:
BURN HAZARD

The vent lever, CI plunger, and surrounding area may be extremely hot, especially during bakeout. Take appropriate precautions.

To bake out the MS:

1. Open **System Control** and click the **Temperatures** tab.
2. Select **Bakeout** and enter a bakeout time of 2 to 6 hours.
3. Use the following temperatures:
 - Trap 220 °C or 10 °C higher than the analysis temperature.
 - Transfer line 280 °C.
 - Manifold 120 °C.
 - Source 220 °C.
4. Click **Start Bakeout**.

Checking Ion Trap Operation

1. After bakeout is finished, reestablish the analysis temperature in the trap for at least 2 hours to achieve thermal equilibrium. The manifold temperature should be at or below 50 °C.
2. Run Auto Tune.
3. Open the Manual Control page and activate the *C:\VarianWS\4000MSservice\240-MS Int (or Ext) Service.mth* file.
4. Check the background using the second segment of the method as follows. Turn on the ion trap. The ionization time should be above 20,000 usec. If the ionization time is below 20,000 usec, continue to bake out the trap or check the GC for contamination.

Cleaning Procedures

The cleanliness of the sources, ion trap, and conversion dynode affects the performance of the MS. How often you clean the instrument depends on the quantity and nature of the samples you run. The troubleshooting section describes some of the symptoms that result from dirty components and offers a schedule.

Cleaning the External Source



**WARNING:
SHOCK HAZARD**

Dangerous high voltages are present. Unplug instrument power cord.

- Perform “Turning Off the MS” on page 38.
- Perform “Removing the Analyzer Assembly” on page 47.
- Perform “Removing the Source and Ion Trap Assembly” on page 43.

Removing the Source Holder

To remove the Source Holder:

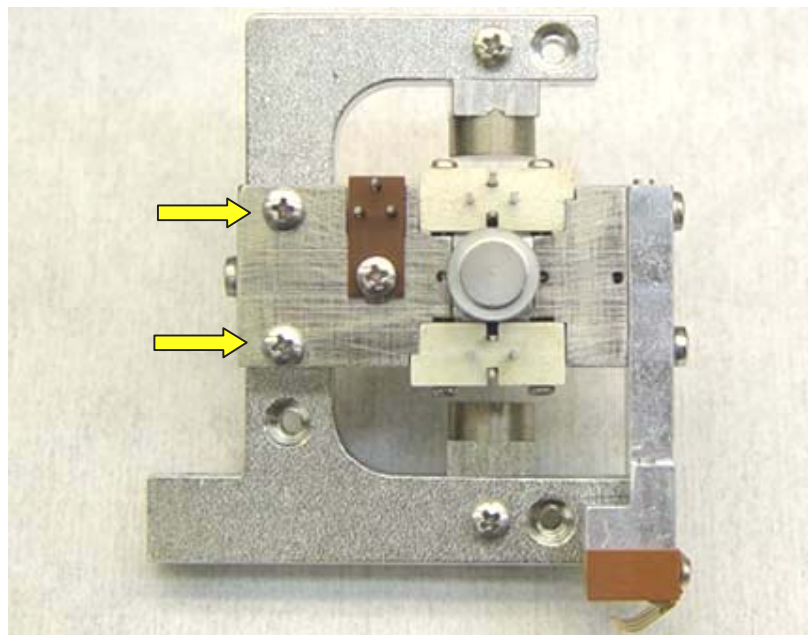

1. Remove the two screws holding the source to the magnet structure.
2. Lift off the source assembly and place it on its side on a low-lint tissue.

Removing the Lenses

To remove the Lenses:

NOTE: The lens parts are anodized to insulate them. Scratches in the black coating can create a conductive path after reassembly.

Place each part on a low-lint tissue.

1. Remove the lens insulator.
2. Remove the lens holding screw.
3. Remove each lens.



Cleaning the Lenses

Materials:

- Cotton swabs
- Isopropyl alcohol or methanol
- Beakers
- Sonicator

To clean the lenses:

1. Clean the center shiny part of each lens with a cotton swab and isopropyl alcohol or methanol.
2. Sonicate the lenses in IPA or methanol for 1 minute.
3. Dry the parts in air or in an oven set to about 120 °C for 30 minutes.

Removing Ion Volumes

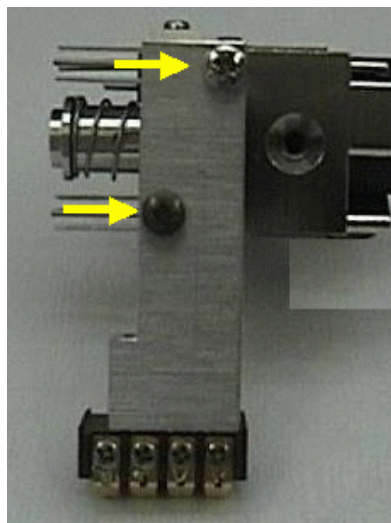

1. Remove the two screws from the source heater block.
2. Place the source heater block on a low-lint tissue.

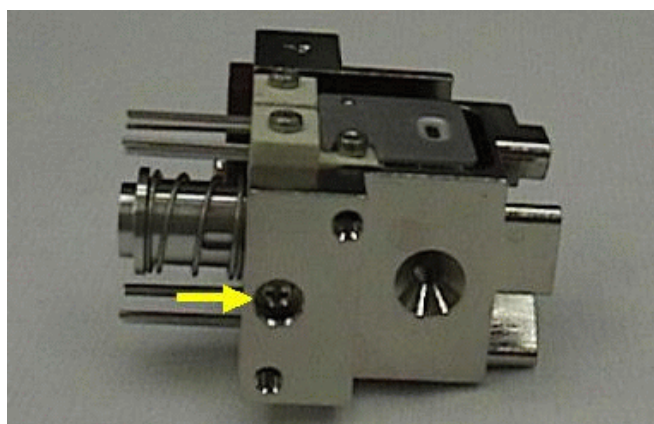

3. Loosen the ion volume retaining screw until the spring pushes the Cl ion volume out.



4. Turn the source assembly so the EI ion volume can be removed. If the ion volume does not come out, loosen the source screw until it does.

Cleaning the EI or CI Ion Volumes

Materials:

- Aluminum oxide
- Cotton swabs
- De-ionized water
- Isopropyl Alcohol or Methanol
- Beakers
- Sonicator

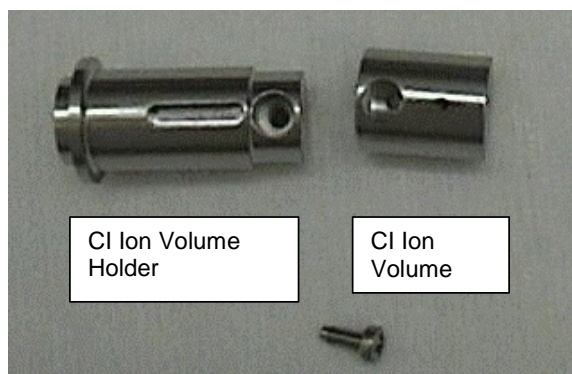

To clean the ion volumes:

1. Remove the spring from the CI ion volume.
2. Remove the screw to separate the ion volume from the ion volume holder.
3. Rinse the ion volume and holder with de-ionized water and sonicate in de-ionized water for 2 minutes.
4. Sonicate another 2 minutes in isopropyl alcohol or methanol.
5. If the volume is discolored, perform the following steps.
6. Dip a cotton swab in de-ionized water and then aluminum oxide.
7. Gently scrub discolored areas with slurry of aluminum oxide and water.

NOTE: Do not let the aluminum oxide dry on the surface.

8. Repeat steps 3 and 4 with parts cleaned with aluminum oxide.
9. Repeat steps 1 through 5 for the EI ion volume.
10. Dry all the parts in air, or place in an oven at about 120 °C for 30 minutes.

Reassembling the CI Ion Volume

1. Line up the large holes in the holder and CI ion volume.
2. Slide the CI ion volume onto the holder.
3. Place the screw through the CI ion volume into the holder and gently tighten. While tightening, ensure that the tip of the screw is centered in the hole in the CI ion volume.

NOTE: Do not over tighten. Over tightening may cause the CI ion volume to bulge and stick while moving. Ensure the volume remains cylindrical.

4. Place the spring over the assembly.

Cleaning the Filaments and External Ion Source Block

The filaments and source block require cleaning when high pressure CI is performed. High pressure CI can coat the filaments with a carbon layer that must be removed to prevent leakage currents.

Materials:

- Aluminum oxide
- Cotton swabs
- De-ionized water
- Isopropyl Alcohol or Methanol
- Beakers
- Sonicator

Removing the Filaments

To remove the filaments:

1. Remove the top two filament screws.

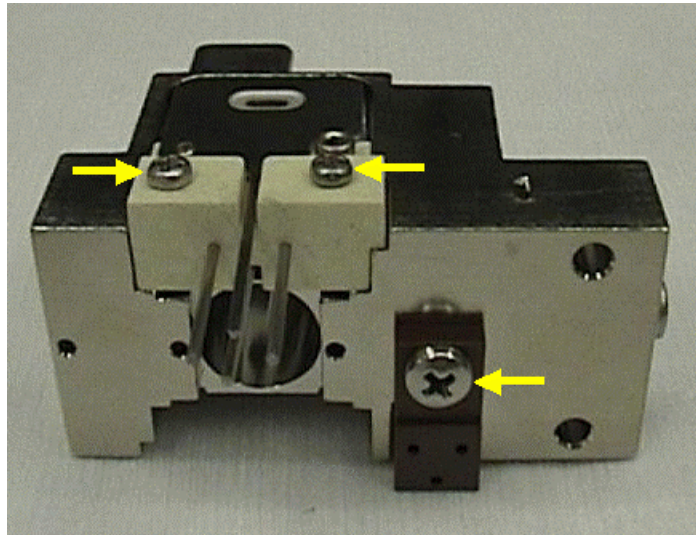

2. Lift out the filament and place on a low-lint tissue.
3. Remove the lens insulator screw and lens insulator.
4. Turn the source over and remove the second filament.

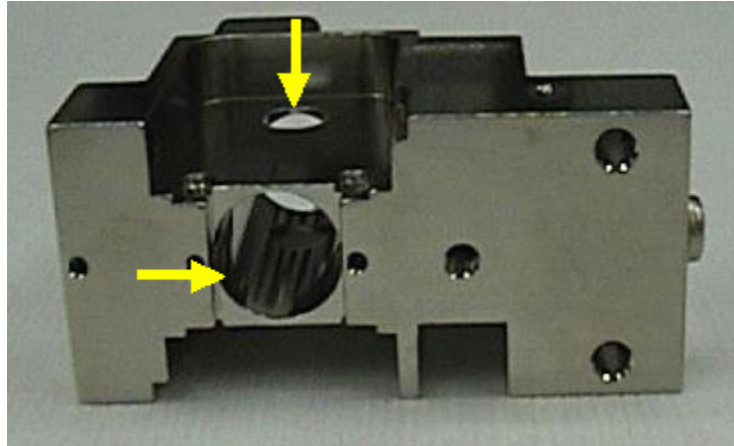

Cleaning the Source Block

To clean the source block:

1. Use a cotton swab and slurry of aluminum oxide and de-ionized water to clean the ion volume hole and the filament entry holes.

NOTE: Do not allow the aluminum oxide to dry on the source block

2. Rinse thoroughly with de-ionized water.
3. Sonicate in de-ionized water for 2 minutes.
4. Sonicate in isopropyl alcohol or methanol for 2 minutes.
5. Dry the parts in air or in an oven set to approximately 120 °C for 30 minutes.

Cleaning the Filaments

To clean the filaments:

1. Remove the lenses from the filament base by removing the two socket cap screws using a 1.5 mm Allen wrench.

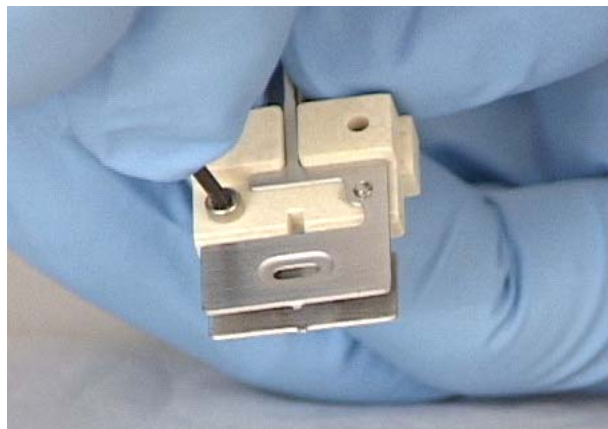

2. Clean the base near and between the filament posts with a piece of super fine grade (400 grit) silicon carbide sandpaper being very careful not to touch or deform the filament, until most of the discoloration is gone.

3. Scrape off the discolored areas as thinly as possible, using a sharp razor blade (or tip of utility knife), until a surface with the same color as base is exposed.
4. Wash off powder and contamination with isopropyl alcohol or methanol. Dry the filament before installing.
5. Clean the lenses with a cotton swab and isopropyl alcohol or methanol. Use another swab.
6. Reassemble the lenses onto the filament base.

Reinstalling the Filaments

To reinstall the filaments:

1. Install the lens insulator and lens insulator screw. Be sure the step in the lens insulator fits into the cut-out in the source.

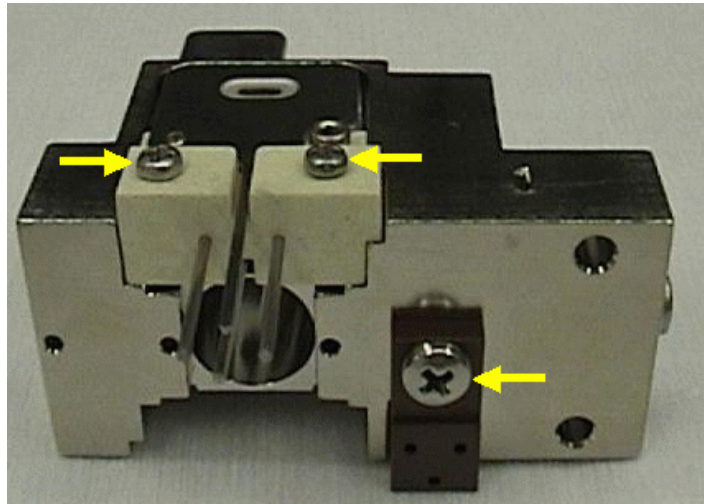

2. Place a filament assembly into the source with the notched side down. Ensure the assembly is fully seated in place.
3. Place the two screws into the screw holes and tighten each screw evenly. Do not over tighten.
4. Turn the source assembly over and repeat these steps for the other filament.

Reassembling the External Source

To reassemble the external source, follow the directions for disassembling it in reverse.

Reinstalling the Ion Volume

To reinstall the ion volume:

1. Position the EI volume so that the holes align with the ion volume screw and transfer line hole.

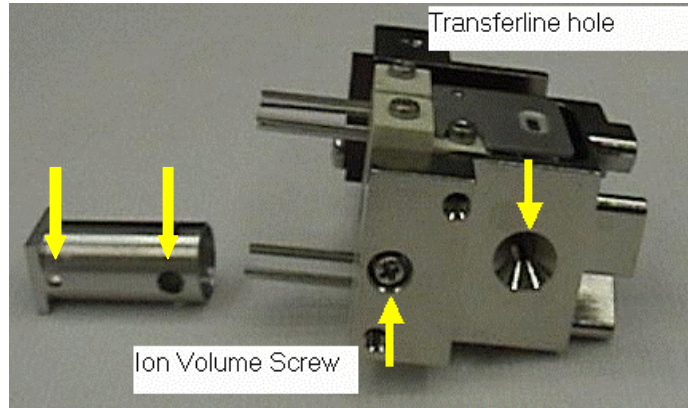

2. Slide the EI ion volume into the source block.

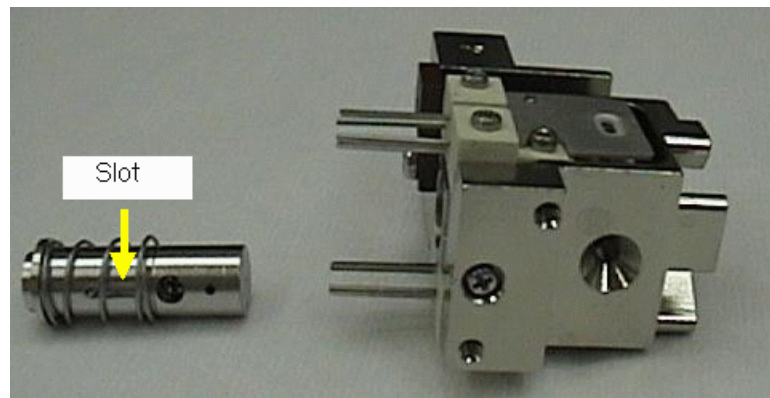

3. Slide the CI ion volume into the source block with the slot aligned with the ion volume screw.
4. Fully compress the spring. Ensure the proper hole in the CI ion volume aligns with the transfer line hole.
5. While holding the CI ion volume in, slowly tighten the ion volume screw. As it enters the slot, captures the CI ion volume. Adjust the slot position to let the CI ion volume slides freely after tightening the screw.

Reinstalling the Lenses

1. Lens 1: Slide the pin through the left hole in the insulator.

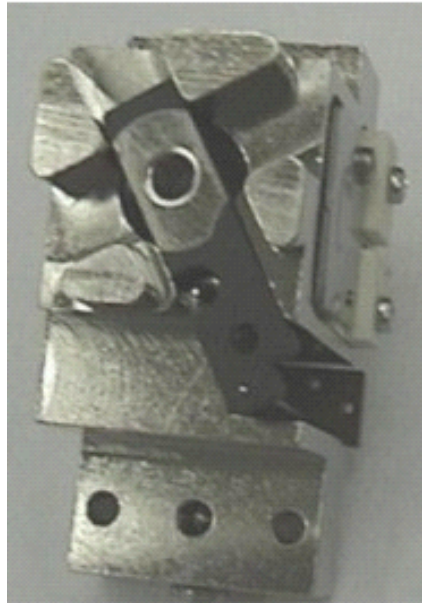

2. Lens 2: Slide the pin through the middle hole in the insulator.



3. Lens 3: Slide the pin through the right hole in the insulator.

4. Attach the screw insulator and the lens screw through the lens and into the source.



5. Push the centering ring onto lens 3.



6. Reinstall the external source assembly and tighten the two source mounting screws. Maintain source symmetry while tightening the screws.
7. Reinstall the source heater assembly.
 - Perform “Reinstalling the Source and Ion Trap Assembly” on page 44.
 - Perform “Reinstalling the Analyzer Assembly” on page 47.
 - Perform “Turning On the MS” on page 49.

Cleaning the Internal Ionization Assembly

- Perform “Turning Off the MS” on page 38.
- Perform “Removing the Analyzer Assembly” on page 41.
- Perform “Removing the Source and Ion Trap Assembly” page 43.

Removing Internal Ionization Assembly

To remove the internal ionization assembly:

1. Place parts on a low-lint tissue.

2. Loosen the two screws holding the internal ionization assembly until you can lift it out. The screws are captured in the source plate.

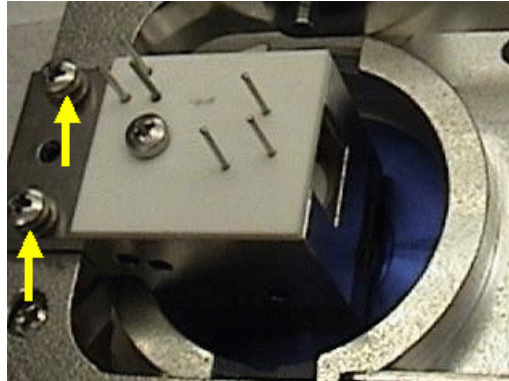

3. Remove the assembly and place it on a low-lint tissue.
4. Remove the filament retention screw.

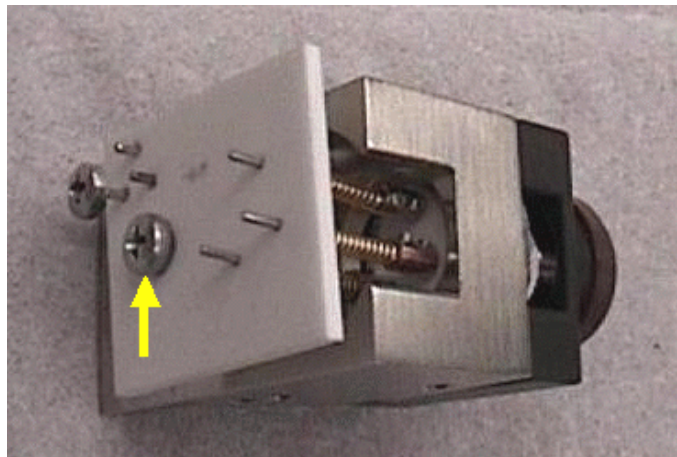

5. Remove the ceramic plate.
6. Remove the filament assembly.
7. Remove the gate retaining screw.

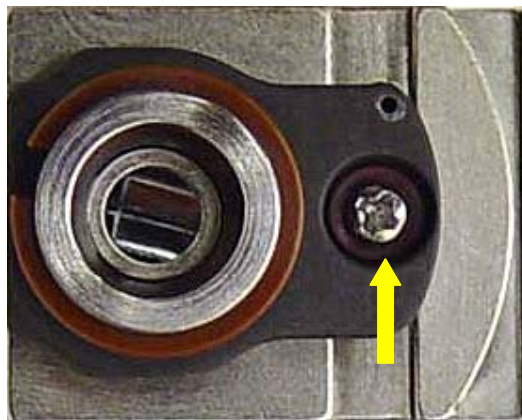

8. The center ring is clipped around the end of the lens. Push a capillary pick into the gap in the ring, lift and slide the ring over the edge of the gate.



9. Pull the insulator off the lens.

Cleaning the Gate

Materials:

- Cotton swabs
- Isopropyl alcohol (IPA) or methanol
- De-ionized water (DI)
- Beaker
- Sonicator

NOTE: The outside of the gate is anodized. Do not scratch the coating or the gate may short to the filament block.

To clean the gate:

1. Clean the shiny center of the gate with a cotton swab and IPA or methanol.
2. Sonicate it in isopropyl alcohol or methanol for 2 minutes.
3. Dry it in air or in an oven set to approximately 120 °C for 30 minutes.

Cleaning Internal Source Base

Materials:

- Aluminum oxide
- Cotton swabs
- De-ionized water (DI water)
- Isopropyl alcohol (IPA) or methanol
- Beaker
- Sonicator



NOTE: Do not let aluminum oxide dry on the base.

To clean the Internal Source Base:

1. Use a cotton swab dipped in slurry of aluminum oxide and DI water to clean the center tube in the internal ionization base.
2. Rinse thoroughly with DI water.
3. Sonicate in DI water for 2 minutes.
4. Sonicate in isopropyl alcohol or methanol for 2 minutes.
5. Air dry or put in an oven set to 120 °C for 30 minutes.

Reassembling the Internal Ionization Assembly

To reassemble the Internal Ionization Assembly:

1. Push the center ring over the gate until it snaps into the groove around the edge.



2. Place the gate on the internal source base.



3. Put the insulator into the screw hole.
4. Place the screw in the insulator and tighten.
5. Place the assembly in the Internal Source Base.
6. Put the ceramic plate over the protruding pins.

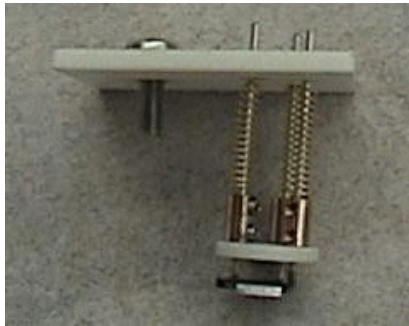

7. Be sure the filament assembly is seated fully flat in the Internal Source Base.
8. Push down on the ceramic plate while installing the holding screw and tighten.



Cleaning Ion Trap Components

Disassembling Ion Trap

1. With the source in place, put the trap assembly on the holder provided with the source pins facing down.
2. Remove the four retaining screws.

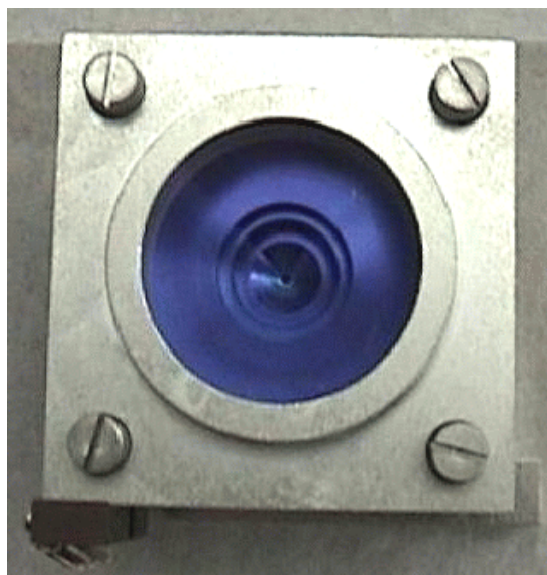

3. Remove the trap oven and place it on a low-lint tissue.
4. Remove the quartz spacer from the trap oven if you are going to clean it.
5. Remove each trap electrode and quartz spacer and place them on a low-lint tissue.

NOTE: Place the end caps cone side up to avoid damaging the electrode.

Cleaning Silica Coated Electrodes



DO NOT use aluminum oxide, other abrasives, or harsh laboratory cleaners because they remove the silica layer. Use only mild detergents (pH between 6 and 7.5).

The protective surface layer of the silica-coated ion trap electrodes is very thin (only about 1 μm) and strongly bonded to the stainless steel body.

Do not use abrasives such as aluminum oxide powder or strongly acidic or strongly basic laboratory cleaners to clean the trap parts because they remove the silica layer.

To clean the silica coated electrodes:

1. Remove the polyimide banana plugs from the end caps.
2. Gently scrub the trap parts with a toothbrush and liquid hand soap or dish detergent (pH between 6 and 7.5).
3. Rinse in DI water.
4. Rinse in methylene chloride or methanol.
5. Air dry or dry in an oven set to about 120 °C for 30 minutes.
6. Replace the banana plugs, in a different hole prior to cleaning.

Cleaning the Quartz Spacers

1. Wipe the surfaces of each quartz spacer with a clean, soft, low-lint tissue dampened with reagent grade acetone and avoid extracting glove material with the acetone.
2. Rinse each quartz spacer with de-ionized water.
3. Rinse each quartz spacer in isopropyl alcohol or methanol.
4. Dry the spacers in air or in an oven set to approximately 120 °C for 30 minutes.

Reassembling the Ion Trap

To reassemble the Ion Trap:

1. Place the first quartz spacer in the bottom half of the trap oven. Ensure the spacer is properly seated in the oven. The spacing around the perimeter outside edge should be the same and the spacer should not move when you touch it. The orientation of the notch in the spacer is not important.

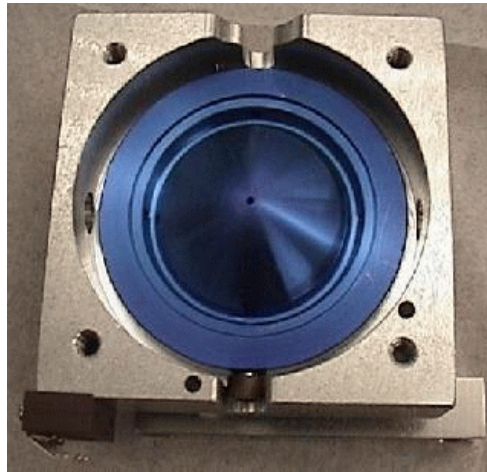

2. Place one of the end cap electrodes (they are identical) on the quartz spacer, cone side up, with the banana plug on the same side as the gold connectors. If necessary, use the end of a cotton swab gently to guide the electrodes into the assembly.



3. Place a quartz spacer on the end cap. Ensure the spacer is seated completely flat on the end cap.



4. Place the ring electrode on the quartz spacer.
5. Place the last quartz spacer on the ring electrode. Ensure that the spacer is seated completely flat on the electrode.

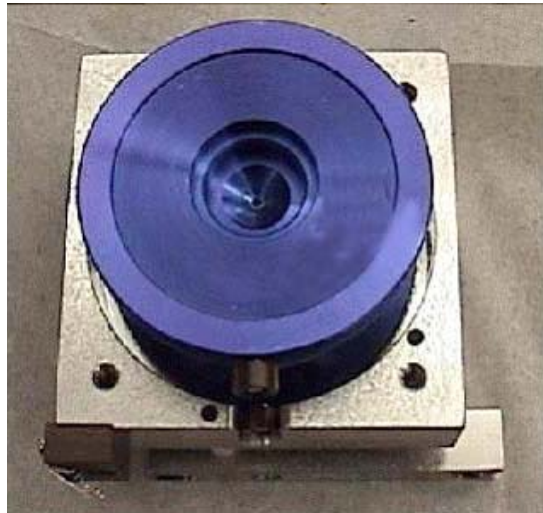

6. Place the last end cap electrode on the quartz spacer with the cone side face down. The banana plug must be on the same side as the lower end cap.
7. Place the last quartz spacer on the end cap electrode. Ensure the spacer is seated completely flat on the end cap.
8. Place the oven top on the electrode stack with the gold connectors on the same side as the lower half. Ensure that the oven and quartz spacers do not have gaps, reassemble if necessary. If the quartz fits tightly, place the quartz assembly in the trap oven before putting the trap oven on the electrode stack.

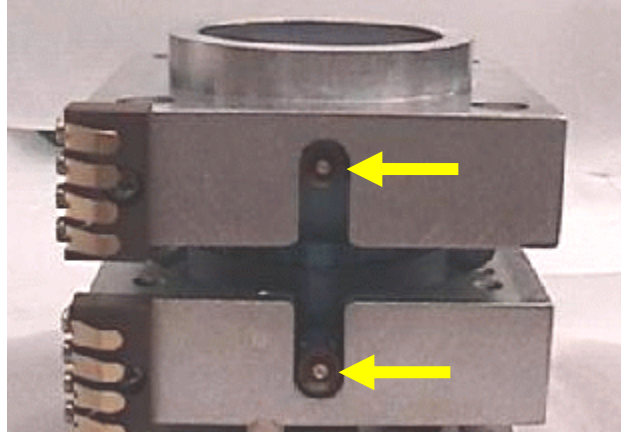

NOTE: The gold connectors on the trap oven must line up on the same side. The banana plugs must be visible in the notches and be seated all the way to the end of the grooves in the trap oven.

9. If there is a gap, disassemble and recheck the alignment of the spacers and electrodes.
10. Evenly screw in the four screws until they are snug.

Reinstalling the Source

1. Put the trap oven screws on the bottom and place the 3 ceramic spacers in their countersunk holes.

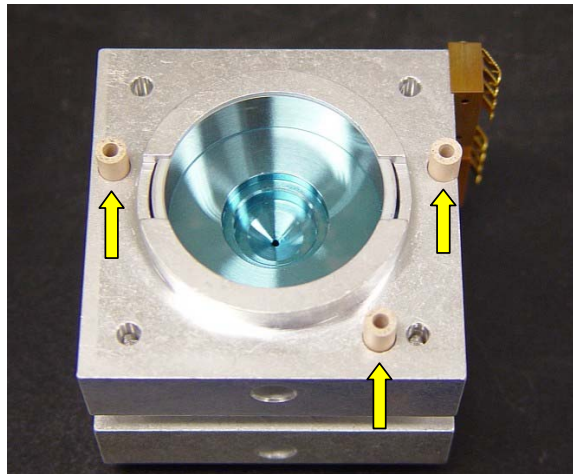

2. Align the magnet structure with the three ceramic spacers, insert the screws, and tighten them.
3. Place the source into the end cap and align the two screws. When the internal source is properly installed, the lens is flat in the end cap and the source plate is flat against the magnet structure.
4. Check the positioning and after aligning it, tighten the screws.

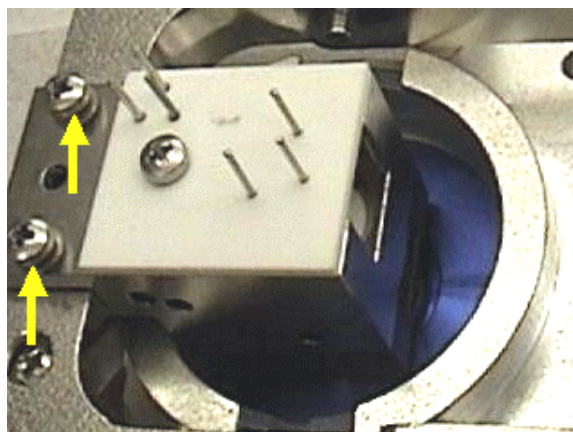

Internal Source

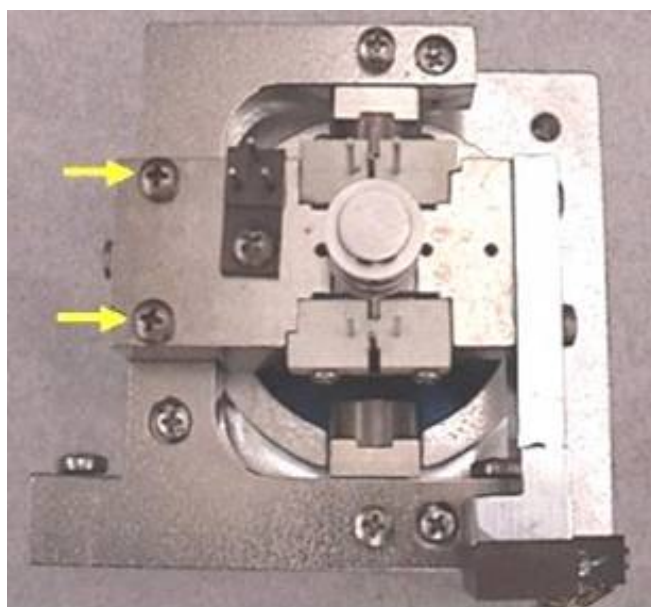

External Source

- Perform “Reinstalling the Source and Ion Trap Assembly” on page 10.
- Perform “Reinstalling the Analyzer Assembly” on page 47.
- Perform “Turning On the MS” on page 49.

Replacing GC Columns

Tools and Materials:

- 3/16 in. wrench
- Ceramic scoring wafer
- 5/16 in. wrench
- Scribing tool
- Graphite/Vespel® ferrule
- For internal mode, use column measuring tool, part number 393180501

- Methanol
- Low-lint tissue

Removing the Capillary Column

To remove the Capillary Column:

1. Perform “Moving MS Away from GC” on page 41.
2. Perform “Turning Off the MS” on page 38.



**WARNING:
SHOCK HAZARD**

Dangerous high voltages are present. Unplug power cord.



3. Loosen the brass nut on the end of the transfer line using a 3/16 in. and a 5/16 in. wrench.
4. Remove the capillary column from the transfer line.
5. Remove the brass nut with the ferrule from the column.
6. Remove the ferrule from the nut and discard the ferrule, or use a new column nut, part number, 394955100.
7. Put the transfer line end of the column, from the inside the GC oven, in the hole in the side of the GC. Leave the free end of the column on the floor of the oven.
8. Loosen the capillary column nut that secures the column to the injector using a 5/16 in. wrench.
9. Carefully remove the nut, ferrule, and column from the injector.
10. Slide the column nut, and the ferrule, off the column end.
11. Carefully lift the column support cage, and the column, from the hanger and remove them.
12. Seal the column ends or insert them into a septum.
13. Store the column and the support cage.

Installing New Capillary Columns

Removing transfer line

1. Remove the 240-MS top cover.



Dangerous high voltages are present. Unplug power cord.



Confirm that the transfer line is cool.

2. Unplug the heater cable for the transfer line from connector J37 on the bulkhead.
3. Grasp the nose of the transfer line. Rotate it counterclockwise while pressing lightly toward the manifold. Gently slide the transfer line away from the manifold.
4. Remove the nose clip, and pull the transfer line away from the analyzer.



5. Wrap the transfer line in clean low-lint tissue and place it on a clean, dry surface.

Installing and Conditioning Columns in the GC

1. Unwind about 60 cm (24 in.) of the MS end of the column from the support cage in the GC.
2. Place the column and cage on the column rack inside the GC oven.
3. Install the GC end of the column into the GC injector (see GC manual for instructions).
4. Purge the column inside the GC oven with carrier gas for at least 15 minutes to remove residual air.
5. Condition the column in the GC oven at least overnight before connecting it to the MS to prevent contamination. Do not exceed the maximum operating temperature for the column.

Preparing Columns for the MS

To prepare the column for the MS:

1. Insert the MS end of the column through the transfer line hole in the right side of the GC.
2. Slide a brass nut on the column with the wide, threaded opening of the nut facing the column end and slide the nut several inches down the column.
3. Set the nut on the column.
 - External Mode: Place a new graphite/Vespel® ferrule on the column with the taper facing the nut. Slide the ferrule, and the nut, about 30 cm (12 in.) down the column.

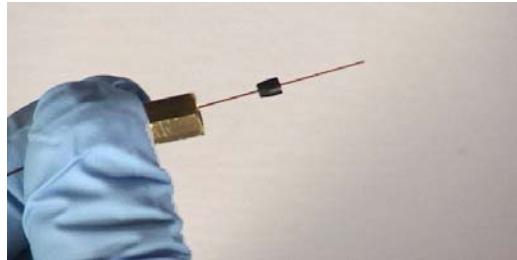

- Internal Mode: If the system is in internal mode, use the column-measuring tool to replace the transfer line tip. If the measuring tip is not available, use a ruler.

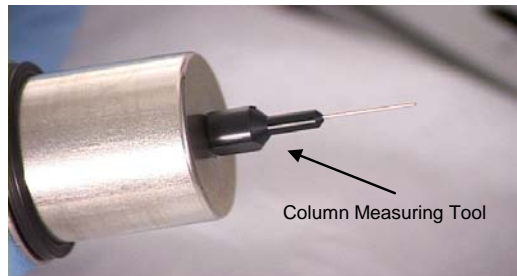

4. Insert the tip of the column carefully into the nose end of the transfer line. Slide the column through the transfer line until the tip of the column projects a few inches beyond the transfer line tip.
5. Score the column once lightly about 2 cm (1 in.) from its end with a ceramic scoring wafer.

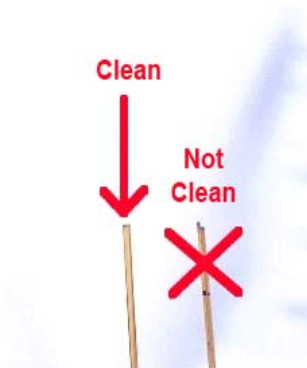

6. Bend the column slightly to break it at the mark. The column should break cleanly.
7. Wipe the last 15 cm (6.0 in.) of the column carefully using a low-lint tissue dipped in methanol. Wipe toward the end of the column to prevent tissue fibers from entering the opening at the column end.
8. Install the brass nut on the end of the transfer line, but do not tighten the nut completely.
9. Position the tip of the column according to the ionization mode.
 - External mode: Position the tip of the column so that about 1 mm (1/32 in.) extends beyond the transfer line tip.
 - Internal mode: The column should just barely extend beyond the end of the measuring tool. If using a ruler, the end of the column should extend 8 mm beyond the internal transfer line tip opening.
10. Tighten the brass nut by grasping the transfer line securely with a 3/16 in. wrench and use a 5/16 in. wrench to tighten the nut until snug, but do not over tighten.



As you tighten the nut, the position of the column in the transfer line may change. If this happens, loosen the nut and readjust the column until the column extends the proper distance from the transfer line tip.

11. For internal mode, replace the measuring tip with the brown transfer line tip.



Internal Tip

12. Clean the tip end of the transfer line with methanol.
13. Place the service loop in the GC oven.

Installing Columns in the MS

1. Remove the analyzer assembly to avoid damaging the transfer line tip.
2. Insert the transfer line into the manifold.
3. Install the clip on the transfer line into the holes provided.
4. Position the transfer line so that the heater cable aligns with the slot on the right side of the transfer line.
5. Gently push the transfer line toward the manifold, and rotate the collar clockwise until the bayonet lock engages.
6. Route the heater cable for the transfer line below the transfer line, through the white retainer and under the thermocouple vacuum gauge.
7. Plug the transfer line heating cable to connector J37.
8. Replace the 240-MS top cover.
9. Gently push the MS toward the GC, until the transfer line nut is visible inside the GC oven. Do not damage the rear pneumatics lines. The boot should fit snugly into the hole on the side of the GC oven.
10. Turn the GC oven on through its keyboard. Press the Column Oven button, and the blue soft key entitled Turn Oven On.
11. Perform "Turning On the MS" on page 49.
12. Condition the new column, to prevent contaminating the MS, after the temperatures of the trap, source, and manifold reach their setpoints.

Replacing Components

Replacing External Source Filaments

- Perform "Turning Off the MS" on page 38.
- Perform "Removing the Analyzer Assembly" on page 41.
- Perform "Removing the Source and Ion Trap Assembly" on page 43.



**WARNING:
SHOCK HAZARD**

Dangerous high voltages are present. Unplug power cord.



CAUTION

When removing the filament screws do not allow ceramic dust to fall into the ion trap. Blow off any dust using a clean pressurized gas.

Removing Filament Assemblies

1. Place the Source/Ion Trap Assembly on a low-lint tissue with the filament screws horizontal. Do not stand the ion trap on end to prevent ceramic dust from falling into the ion trap.
2. Remove the two Phillips screws.

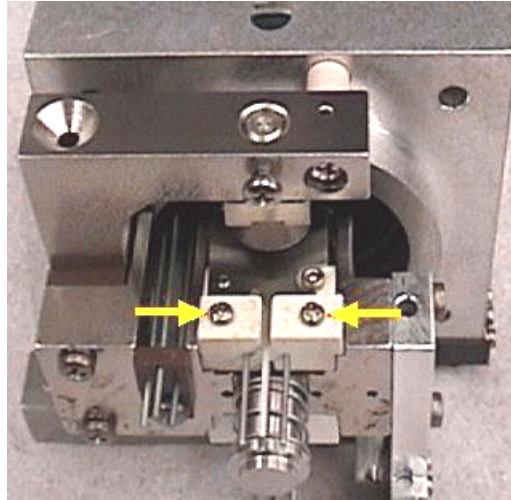

3. Carefully lift the filament assembly out of the source holder.
4. Inspect the metal disc, part number 393176101, on the magnet for discoloration and carbon build up. If the disk looks dirty, slide the disc off and place a new one on the magnet.
5. Turn the assembly over and repeat these steps for the other filament and magnet disc.

Installing New Filament Assembly

1. Place the new filament into the source holder with the notched side down. Ensure the filament is seated firmly.

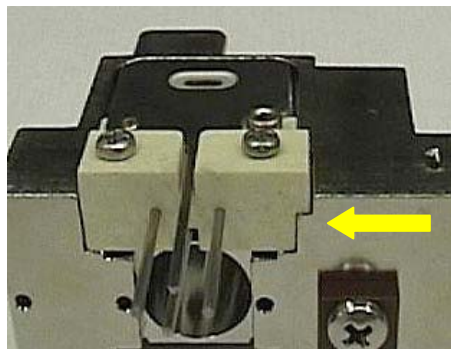

2. Place the two screws into the screw holes and tighten each screw evenly. Do not over tighten.
3. Turn the assembly over and repeat the steps for the other filament.



CAUTION

New filaments are conditioned during the first few days of operation. Check the tune of the filaments daily during the first few days of full operation until the filaments remain solidly in tune.

- Perform “Reinstalling the Source and Ion Trap Assembly” on page 44.
- Perform “Reinstalling the Analyzer Assembly” on page 47.
- Perform “Turning On the MS” on page 49.

Conditioning the Filaments

To condition the filaments:

1. Run the electron lens voltage Auto Tune three times.
2. Run the method **External_Filament_Conditioning.mth** to cycle the filament power on and off.
3. Run Auto Tune two more times. The filaments ready.
4. During the next 2 or 3 days, tune the lens voltages as required. See the Ion Source indicators on the diagnostics page. If the Ion Source deviation is larger than 2 μ Amps, the filament is probably out of tune.

Replacing Internal Source Filaments

- Perform “Turning Off the MS” on page 38.
- Perform “Removing the Analyzer Assembly” on page 41.
- Perform “Removing the Source and Ion Trap Assembly” on page 44.



WARNING: SHOCK HAZARD

Dangerous high voltages are present. Unplug power cord.

Removing Old Filament Assemblies

To remove the old Filament Assembly:

1. Remove the filament retention screw and place it on a low-lint tissue.

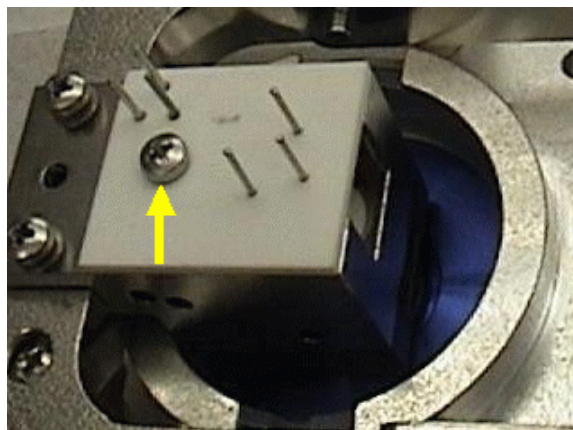

2. Lift the ceramic plate and remove the filament assembly.

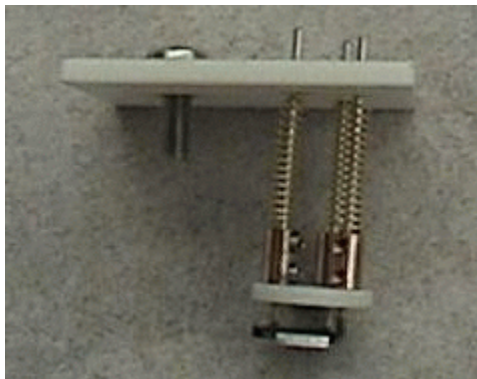

Installing New Filament Assemblies

1. Transfer the springs to the new filament assembly.
2. Place the assembly in the filament block.
3. Reinstall the ceramic plate over the protruding pins.



4. Ensure that the filament assembly is seated flat in the filament block.
5. Reinstall and tighten the holding screw.
 - Perform “Reinstalling the Source and Ion Trap Assembly” on page 44.
 - Perform “Reinstalling the Analyzer Assembly” on page 47.
 - Perform “Turning On the MS” on page 49.

Replacing the Electron Multiplier

- Perform “Turning Off the MS” on page 38.
- Perform “Removing the Analyzer Assembly” on page 47.



**WARNING:
SHOCK HAZARD**

Dangerous high voltages are present. Unplug power cord.

Removing Old Electron Multipliers

1. Remove the two screws holding the multiplier cover in place.

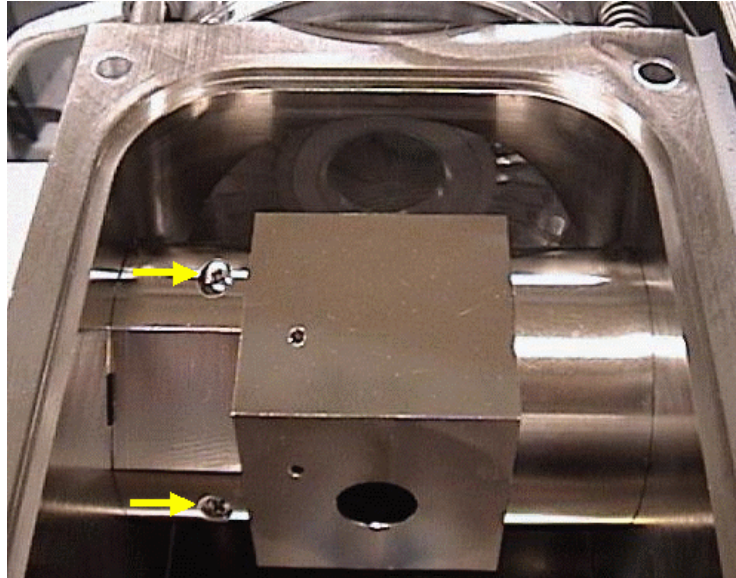

2. Grasp the squared part of the cover and lift it straight out.
3. Place the cover on a low-lint tissue.
4. Loosen both multiplier retainer screws one turn.

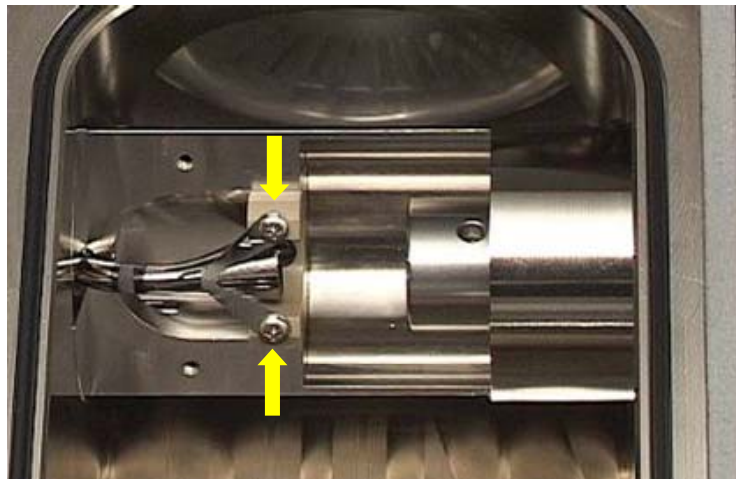

5. After the retainer bracket swings down, in the direction of the arrow, remove the multiplier.



Installing New Multiplier

1. Place the multiplier in the holder.
2. Press down and to the left to engage fully the multiplier with the clip at the bottom of the holder. If the clip does not engage properly, the performance is adversely affected. The horn should be near the centerline of the plastic holder.
3. Swing the holding bracket back into position and tighten the bottom screw.
4. Tighten the top screw.
5. Check the position of the multiplier. It must be centered under the holding bracket. Be sure the notch in the multiplier cover is aligned with the throat of the multiplier.
6. Remove particles.

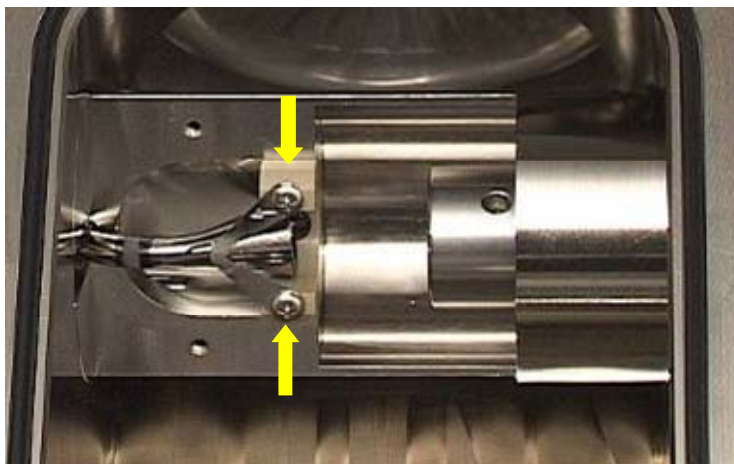

7. Push the cover into place. It should fit tightly.
8. Reinstall and tighten the two screws.
9. Performing the following:
 - Perform "Reinstalling the Analyzer Assembly" on page 41.
 - Perform "Turning On the MS" on page 49.

Replacing the Damping Gas Getter

The getter in the damping gas line removes water and contaminants from the helium supply that serves as the damping gas. How often you replace it depends on the number of samples you analyze and how much water and other contaminants they contain. The replacement kit, part number 393112491 has detailed instructions.

Replacing the Turbomolecular Pump

The Turbomolecular Pump replacement kit, part number 393111991, has detailed instructions for replacing the pump.

Tools

- Phillips Head Screwdriver
- L-Shaped 6 mm Allen wrench, from the 240-MS Ship Kit
- Screen Pick, from the 240-MS Ship Kit

To replace the Turbomolecular Pump:

1. Perform "Turning Off the MS" on page 38.



**WARNING:
SHOCK HAZARD**

Dangerous high voltages are present. Unplug power cord.

2. Follow the replacement procedure included with the Turbo Replacement Kit.
3. Perform "on page 49. Do not start **System Control**. Allow the turbomolecular pump to go through a SoftStart conditioning process for 30 minutes.
4. Start **System Control** and go to the **Startup/Shutdown** page if necessary.
5. Perform "Turning On the MS" on page 49.
6. Perform "Baking Out the MS" on page 51.

Filling the Calibration Gas Vial

The calibration compound is perfluorotributylamine (PFTBA), chemical formula $C_{12}F_{27}N$. This compound is also known as FC-43 (fluorocarbon-43).

NOTE: Do not vent the vacuum system before filling the Cal Gas vial. Close the Cal Gas needle valve, by turning it clockwise.

To fill the Cal Gas vial:

1. Loosen the two retaining screws about 2-3 turns with a Phillips screwdriver.
2. Pull the Cal Gas vial down gently with a slight twisting motion until it clears the pneumatics manifold.
3. Refill the vial using a Pasteur pipette until the vial is just less than half-full with PFTBA compound, part number 392035300. Do not overfill the vial to avoid inconsistent Cal Gas flow.
4. Store the remaining PFTBA in the capped spare vial, part number 0393111201, provided in the kit, or in a 2 mL autosampler vial.

5. While holding the vial vertically, carefully push the vial into the Cal Gas port on the manifold with a slight twisting motion.

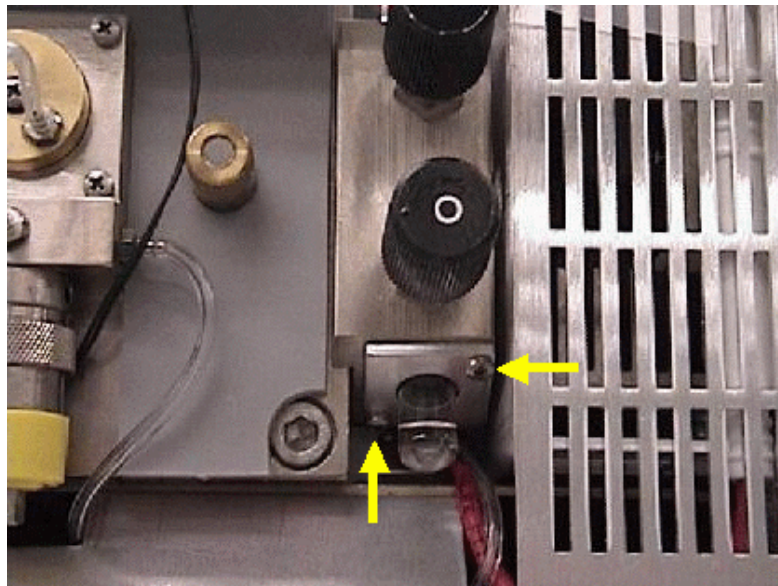

6. After pushing the vial in completely, tighten the retaining screws.
7. Open the Cal Gas needle valve 10 turns counterclockwise. Leave the needle valve open for at least 30 minutes to allow excess Cal Gas and water vapor to be pumped away.
8. Open the **Checks and Adjustments** tab in **Manual Control**, select **Cal Gas Adjustment**, and click **Start**.
9. Adjust the **Cal Gal** pressure so that the indicator bar is near the center of the display, the OK region.

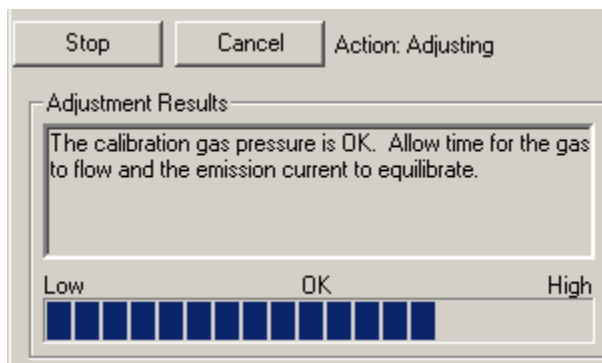

NOTE: Other adjustments that affect ion time, such as the multiplier gain, filament current and background levels influence this adjustment.

Changing Ionization Mode

Changing ionization modes requires changing the source and possibly moving the transfer line.

The following are required for any reconfiguration:

- Perform “Turning Off the MS” on page 38.
- Perform “Removing the Analyzer Assembly” on page 41.
- Perform “Turning On the MS” on page 49.

The following may also be required

- Perform “Reinstalling the Analyzer Assembly” on page 47.

Changing from Internal to External Mode

1. To switch sources from internal to external, see “Switching Between External and Internal Sources” on page 84.
2. To switch the transfer line position from entering the Ion Trap to entering the external source, see “Changing the Transfer Line from Internal to External” on page 86.

Changing from External to Internal Mode

1. To switch sources from external to internal, see “Switching Between External and Internal Sources” on page 84.
2. To switch the transfer line position from entering the external source to entering the Ion Trap, see “Changing the Transfer Line from External to Internal” on page 84.

Changing from Internal to Hybrid Mode

1. To switch sources from internal to hybrid, see “Switching Between External and Internal Sources” on page 84.
2. See “Installing or Removing the Hybrid Plug” on page 87.

Changing from External to Hybrid Mode

1. To switch the transfer line position from entering the external Source to entering the Ion Trap, see “Changing the Transfer Line from External to Internal” on page 84.
2. To change from Hybrid Mode to External Mode see “Installing or Removing the Hybrid Plug” on page 87.
3. To switch the transfer line position from entering the Ion Trap to entering the external Source, see “Changing the Transfer Line from Internal to External” on page 86.
4. To change from Hybrid Mode to Internal Mode, see “Installing or Removing the Hybrid Plug” on page 87.

5. To switch sources from external to internal, see “Switching Between External and Internal Sources” on page 84.

Switching Between External and Internal Sources

To switch between external and internal sources:

1. Perform “Removing the Source and Ion Trap Assembly” on page 43.
2. Loosen the three screws, pull out the existing source, and put it on a low-lint tissue. Leave the ceramic spacers in place.

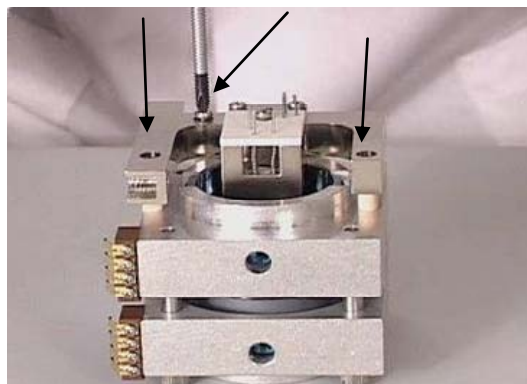

3. Use the screws from the removed source to install the replacement source.
4. Put the replacement source with the three screws aligned, into the ceramic spacers. If switching to external mode, be sure the centering ring is in place. Retighten the three screws. Store the removed source in the box provided.
5. Perform “Reinstalling the Source and Ion Trap Assembly” on page 44.

Changing the Transfer Line from External to Internal

To change the transfer line from external to internal:

1. Perform “Moving MS Away from GC” page 41.
2. Unplug the heater cable for the transfer line from connector J37 on the bulkhead.
3. After the transfer line is cool, remove the transfer line assembly, including the weldment, from the manifold by loosening the four captive screws holding it in place. Do not lose the sealing O-ring.
4. Remove the external tip and replace it with the internal measuring tool or use a ruler.



5. Lightly score the column once at the end of the measuring tip with a sapphire or carbide tipped scribing tool or ceramic scoring wafer.
6. Break the column cleanly using your hands

NOTE: If a measuring tip is not available, cut the end of the column 8 mm (0.315 in.) beyond the opening of the internal transfer line tip after the internal tip is installed.

7. Remove the measuring tool.
8. Screw the brown polyimide internal tip onto the transfer line.
9. Clean the column and surrounding area with methanol and a low-lint wipe.



Internal Tip

10. Return the transfer line assembly to the manifold, position it towards the rear of the instrument.
11. Tighten the four screws and ensure that the O-ring is clean and is seated properly in the manifold groove without kinks or twists.

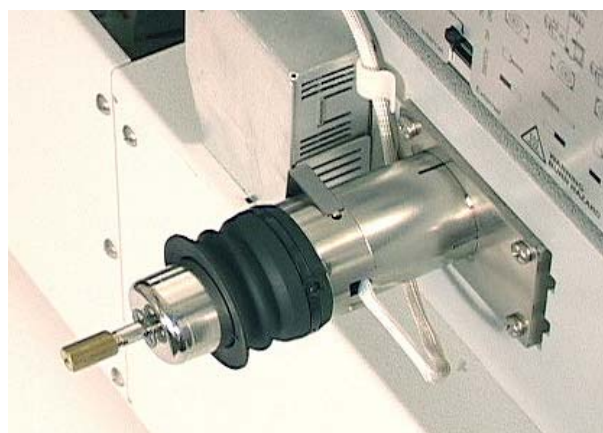

12. Place the heater cable for the transfer line through the white retainer clip on the side of the manifold and under the thermocouple gauge.
13. Plug the heater cable into J37 on the bulkhead.
14. Change the ionization mode switch to the internal position on the left.

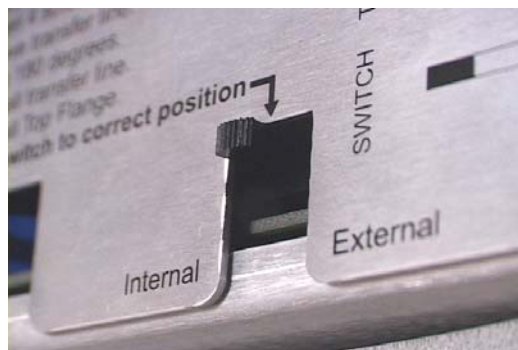

Changing the Transfer Line from Internal to External

1. Perform "Moving MS Away from GC" page 41.
2. Unplug the heater cable for the transfer line from connector J37 on the bulkhead.
3. After the transfer line cools, remove the transfer line assembly, including the weldment, from the manifold by loosening the four captive screws. Do not lose the sealing O-ring.
4. Remove the internal tip and replace it with the long metal external transfer line tip provided with the external source. If necessary, use a 3/16 in. wrench to stabilize the transfer line and a 5/16 in. wrench to remove the tip.

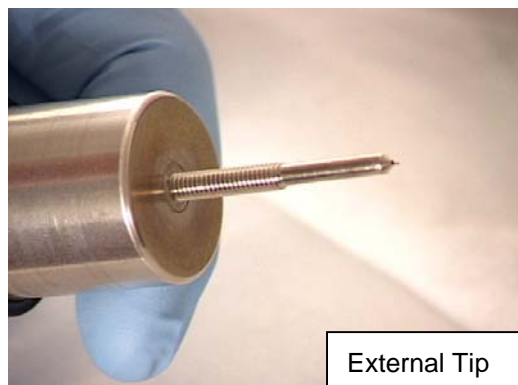

5. Loosen the brass nut at the GC side of the transfer line and then move the column until it extends 1 mm (0.04 in.) from the end of the tip. If you cannot move the column do the following. Cut the column before the transfer line, remove the ferrule from the brass nut, and insert the column with a new ferrule as described in the column replacement procedure.
6. Replace the transfer line assembly, position it towards the front of the instrument, and tighten the four screws. Ensure that the O-ring is clean and seated properly in the manifold groove without kinks or twists.
7. Put the heater cable for the transfer line through the white retainer clip on the side of the manifold and under the foreline line. Plug the cable into J37 on the bulkhead.

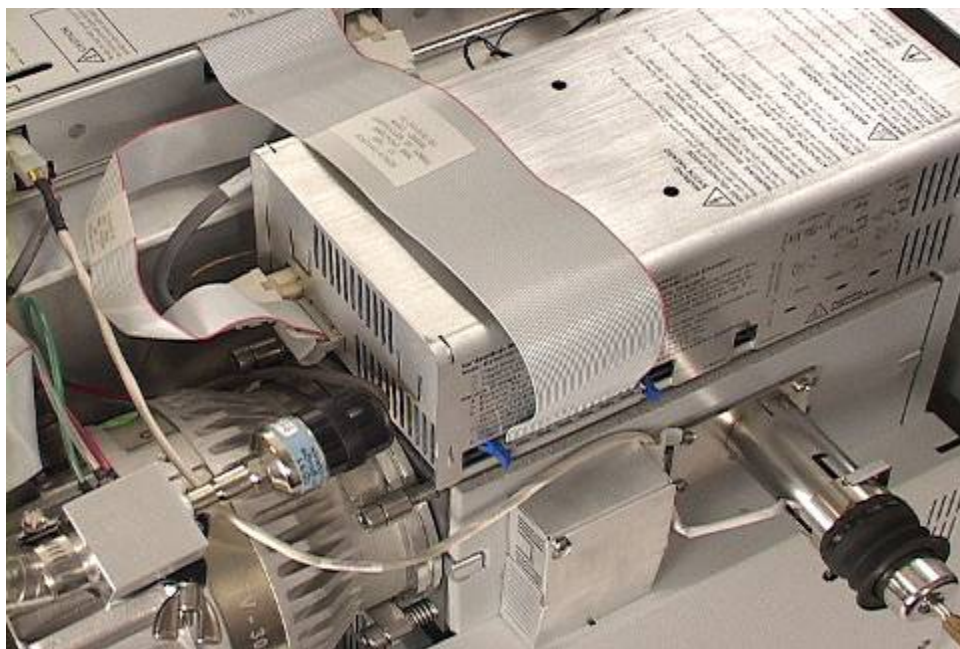

8. Change the position of the ionization mode switch to the external position, which is on the right.

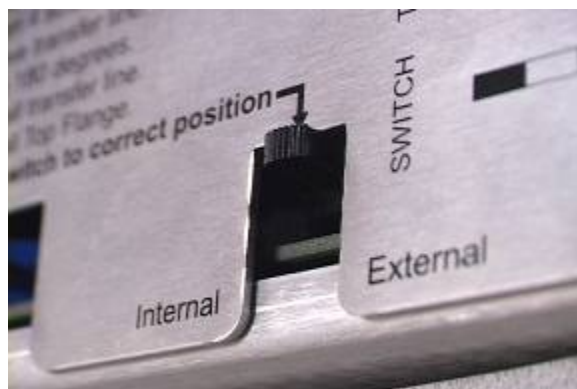

Installing or Removing the Hybrid Plug

Hybrid operation requires plugging the unused transfer line hole in the CI Volume to prevent reagent gas from escaping through the high-pressure CI source.

To install or remove the hybrid plug:

1. Install the supplied plug in the transfer line hole in the external source by inserting the plug and turning until the plug engages with the side of the source heater block.
2. Remove the plug by turning it until it disengages.

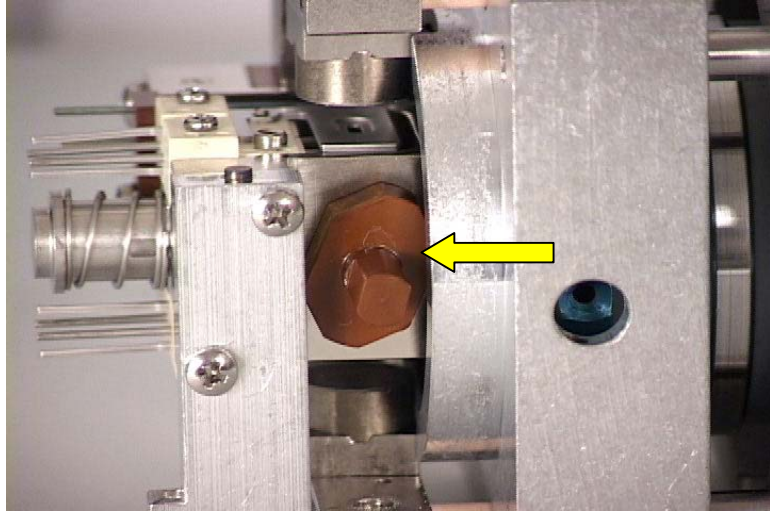

Chemical Ionization Options

Introduction

Chemical ionization (CI) provides mass spectral data that complements electron ionization (EI) data for chemical analysis. The 240-MS offers three optional modes of CI operation.

- Internal Mode--positive CI (PCI)
- External Mode--positive or negative CI (PCI/NCI)
- Hybrid Mode--positive or negative CI (PCI/NCI).

NOTE: The CI and Hybrid modes are options for the 240-MS. If your system does not have these options, you can purchase them.

Internal CI

In internal CI, the CI reagent gas (from an external gas cylinder) enters the analyzer through 4 mL/min restrictor tubing. The reagent gas is ionized by EI to form reagent ions. These reagent ions ionize sample molecules entering the analyzer with the helium carrier gas from the column. The procedures for operating and adjusting reagent gases for the internal CI option are described in the first part of this section. Internal CI is only done in PCI mode.

If you have an additional Liquid CI Inlet (or LCI Inlet) option, you can select other liquids as sources for CI. A 50 mL/min restrictor lets reagent through the LCI Inlet for internal CI. The procedures for operating this option and switching between Liquid and Gaseous CI is described later in this section.

External CI

In external CI, the CI reagent gas (from an external gas cylinder) enters the external ion source through a 4 mL/min restrictor tubing. The software inserts a special CI volume is automatically inserted into the EI volume to create a high-pressure environment that enhances CI reactions. The reagent gas is ionized by EI to form reagent ions. These reagent ions react immediately with sample molecules as they enter the external ion source. These reactions may form both positive and negative ions. Depending if the analysis is for positive or negative CI, the ions with the selected charge are carried into the ion trap for analysis. The use of liquid CI reagents is not recommended for external CI because the pressure of relatively nonvolatile liquid reagents is too low for efficient CI processes to occur in external PCI or NCI modes.

Hybrid CI

In the hybrid mode, the CI reagent gas (from an external gas cylinder) enters the external ion source through restrictor tubing. In the standard hybrid High Pressure Source (HPS), a high-pressure CI volume is automatically inserted into the EI volume to create a high-pressure environment that enhances CI reactions. The reagent gas is ionized by EI to form reagent ions. Both positive and negative ions may be formed in these processes and reagent ions of either positive or negative charge enter the ion trap immediately. The user specifies the polarity of the ions that are carried into the ion trap.

After reagent ions are stored for the designated time in the ion trap, waveforms are applied to isolate only the ions within the designated mass range. Finally, the chosen reagent ions react with the neutral analytes entering the ion trap through the GC column.

An additional Liquid CI Inlet (or LCI Inlet) option allows the use of certain liquids as sources for CI. A 200 mL/min restrictor tubing admits reagent through the Liquid CI Inlet while in hybrid mode. The operation of this option and switching between Liquid and Gaseous CI is described later in this section.

Installing CI Reagent Gas

Before installing the CI reagent gas supply, perform the following:

1. Check the 240-MS system for leaks
2. Tune the instrument in EI mode

To install CI reagent gas:

NOTE: The inlet gas line must be as short as possible.

1. Secure the gas cylinder close to the rear of the 240-MS.
2. Attach a 4 mL/min restrictor tube c to the two-stage gas regulator using a 1/8 in. Swagelok fitting.
3. Attach the other end of the restrictor through the CI Gas inlet into the MS. Ensure the gas line is long enough to reach the back of the 240-MS and accommodates the movement of the MS 9 inches (23 cm) to the right (for access to the transfer line and turbomolecular pump).

NOTE: Do not store gas cylinders or lecture bottles where they can damage cables or gas lines. Secure them according to standard safety practices. Support lecture bottles, which have rounded ends, with a device similar to Matheson Model 505 Non-Tip Stand.

CI Reagent Gas Requirements

Methane and isobutane are the recommended reagent gases for CI.

Use high-purity reagent gas for maximum sensitivity and good spectral quality. Impurities can react with sample ions, creating confusing mass spectral data.

The amount of reagent gas consumed during CI operation is very low (typically 1 to 2 mL/minute). Select the gas cylinder size appropriate for your needs.

The requirements are:

Methane	Methane should have a purity of 99.99% or better. Use a gas cylinder with a two-stage pressure regulator with a stainless steel diaphragm and maximum inlet pressure of 30 psi (200 kPa).
Isobutane	Isobutane should have a purity of 99.99% or better. Use a gas cylinder with a two-stage pressure regulator with a stainless steel diaphragm and maximum inlet pressure of 30 psi (200 kPa).

The CI reagent gas should contain less than 1 ppm of water. Water in the CI reagent gas may interfere with CI operation.

If you need a longer restrictor line than the 4 mL/min line supplied, use clean copper or stainless steel gas lines for methane or isobutane. All gas lines should be free of oil (and other contaminants) and preferably flame dried. If possible, use the clean copper tubing from the GC Start-Up Kit.



WARNING:
CHEMICAL HAZARD

DO NOT flame! Dry the reagent gas lines with CI reagent gas present.

Setting Up the CI Reagent Gas Supply



WARNING:
CHEMICAL HAZARD

CI reagent gases may be hazardous. Use proper protection when installing the reagent gas.

To set up the CI reagent gas supply:

1. Enter **System Control** and select **Manual Control**.

2. Ensure the electron multiplier, filament, and RF voltage are off. The Multiplier, Filament (Ion Source), and RF text should be red or black, not green.

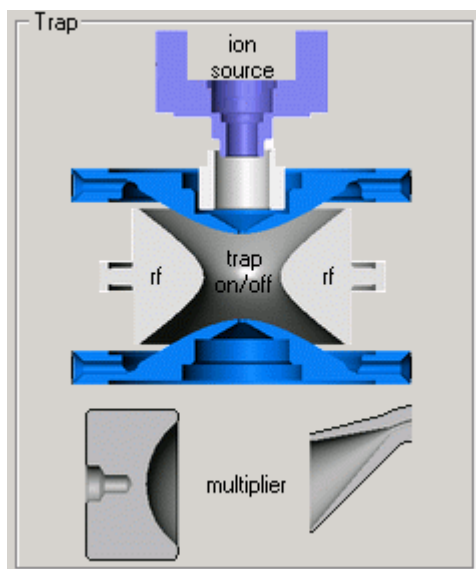

NOTE: Two solenoid-operated valves control the flow of CI reagent gas into the manifold. A needle valve, behind the MS door, controls the amount of reagent gas flowing into the manifold. You can use the CI button on the Instrument Control display to open and close the valves.

3. Ensure that the CI Gas solenoid valves are closed. When these valves are closed, the CI Gas icon to the left of the ion trap symbol is not green.
4. Install a two-stage pressure regulator on the reagent gas cylinder or lecture bottle. Tighten the connection securely.

NOTE: A two-stage pressure regulator typically has a secondary valve, pressure adjustment valve, a supply pressure gauge, and a delivery pressure gauge

- Turn the reagent gas on and off with the main valve on the cylinder or lecture bottle.
- Use the secondary valve on the pressure regulator for coarse control of the flow of gas from the gas cylinder up to the pressure adjustment valve.
- Monitor the gas pressure in the bottle using the supply pressure gauge.
- Set the head pressure of the gas delivered to the MS using the pressure adjustment valve.

5. Connect one end of the 1/8 in. OD gas supply line to the pressure regulator.

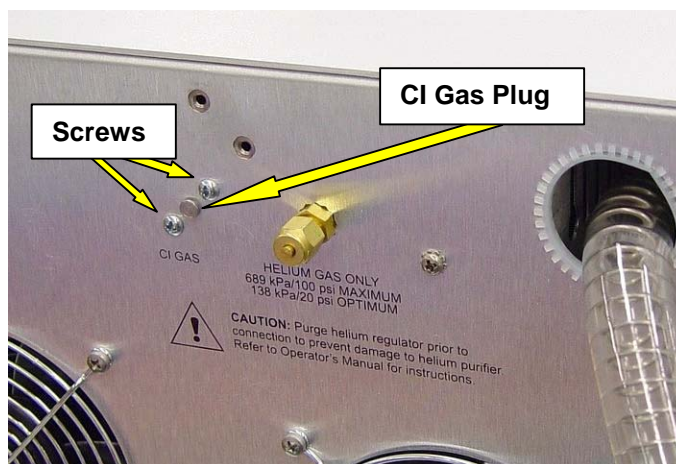

6. Loosen each of the two screws, on the back of the instrument that hold the plug in the CI Shutoff Manifold, 2 to 3 turns.
7. Remove the plug by pulling straight out and twisting.
8. Use the 4 mL/min restrictor tube for the supply line between the gas cylinder and the CI shutoff manifold. A ferrule is not required on the MS end of the tube, because an elastomer O-ring creates the seal.
9. Insert the restrictor tube into the CI shutoff manifold hole (the hole for the plug) until it is firmly seated. Tighten the two screws.
10. Ensure that the secondary valve on the regulator on the gas cylinder is closed.
11. Open the main control valve on the lecture bottle.
12. Open the secondary valve and adjust the pressure valve to approximately 20 psi.
13. Open the MS door. Verify that the CI GAS needle valve is turned fully counterclockwise.
14. Flush the gas line of air and water vapor by doing the following.
15. Monitor the foreline pressure on the diagnostics screen. Do not allow the foreline pressure to exceed 500 mTorr for more than 20 seconds.
 - a. Turn the adjustment valve clockwise to reduce the pressure.
 - b. Open the CI Gas solenoid valves by clicking the CI icon in the Control and Status field of the Manual Control tab in System Control. After the valves opened, the CI button becomes green.
 - c. Evacuate the CI reagent supply line for about 30 minutes.

Checking the Reagent Gas Plumbing for Leaks

Check for air leaks in the connections for the reagent gas and water vapor in the gas line using leak detection gas as described in the Troubleshooting section.

Locate and follow the procedure modification that fits your leak detection results.

Large Air Leak

1. Check the tightness of the CI GAS fitting on the rear of the instrument and the fitting on the pressure regulator.
2. Check the air/water spectrum.

Excess Water Vapor

If the 19/18 ratio is high, water may be in the gas line and there may be an atmospheric air leak in the reagent gas plumbing. Do the following:

1. Close the CI solenoid valves to shut off the flow of reagent gas into the manifold. If necessary, click the **CI** icon in the **Control and Status** field of the **Manual Control** tab in **System Control**. When the valves are closed, the CI button is black or red--not green.
2. Recheck the air/water spectrum. If the peak at mass 19 (water) decreases, then water is present in the gas line, perform step 3. If the peak at mass 19 does not decrease significantly, little water is present in the gas line and the system probably has an air leak. Fix the leak as described in the Troubleshooting Section. Check the following for leaks:
 - CI GAS port on the rear of the MS
 - Fitting that connects the reagent gas line to the pressure regulator.
3. Flush excess water from the gas line by doing the following:
 - a. Ensure that the electron multiplier, filament, and RF voltage are off.
 - b. Open the main valve on the lecture bottle. (The secondary valve on the pressure regulator should be open.)
 - c. Turn the CI needle valve fully counterclockwise to divert gas to foreline pump.
 - d. Open the CI Gas solenoid valves and let the system pump down for about 1 hour.
 - e. Close the main valve on the CI Gas cylinder but keep the CI GAS solenoid valves open. Let the system pump down for about 15 minutes.
 - f. Recheck the air/water spectrum. If excess water is not present, follow the Setting Delivery Pressure of the CI Reagent Gas procedure in the next section.

Setting CI Reagent Flow for Internal Mode

1. Ensure that the CI Gas solenoid valves are closed. If necessary, click the **CI** icon in the **Control and Status** field of the **Manual Control** tab in **System Control**. When the valves are closed, the CI button is black or red not green.
2. Open the main valve on the lecture bottle.
3. Set the head pressure to about 20 psi using the pressure adjustment valve on the regulator.

The system is ready to operate in the CI mode.

Parameters for CI Internal Mode

Reagent Gas	Methane	Isobutane	Acetonitrile	d3-Acetonitrile	Methanol
Reagent Low Mass (m/z)	15	35	35	35	25
Reagent High Mass (m/z)	45	65	60	60	50
Reaction Storage Level (m/z)	35	35	33	33	25
Ejection Amplitude (v)	15	15	15	15	15
Target TIC	5000	5000	5000	5000	5000
Maximum Ionization Time (μsec)	2500	2500	2500	2500	2500
Maximum Reaction Time (μsec)	100	100	100	20*	100

NOTE: Use short reaction times for deuterated reagents. Longer reaction times allow more H/D to exchange with background water and the resulting spectrum has more [M+H]⁺ and less [M+D]⁺.

CI Reagents External Mode Default Parameters

Reagent Gas	Methane	Isobutane	Ammonia	Acetonitrile	d3-Acetonitrile	Methanol
CI Background (m/z)	45	65	35	60	60	50
Target TIC	5000	5000	5000	5000	5000	5000
Maximum Ionization Time (μsec)	2500	2500	2500	2500	2500	2500
Maximum Reaction Time (μsec)	100	100	100	100	20*	100

Ion Intensities for Standard CI Reagents

The recommended pressures for CI reagent gases and liquids based in ion intensities are listed on the following table.

Methane	Adjust the reagent gas pressure until: The peak height at m/z 17 (CH_5^+) is about 25% of that at m/z 29 (C_2H_5^+). The ratio of the ions at m/z 17 to m/z 16 is about 10:1. The ion at m/z 41 (C_3H_5^+) is visible.
Isobutane	Adjust the reagent gas pressure until: The peak heights at m/z 57 [$(\text{CH}_3)_3\text{C}^+$] and m/z 43 [$(\text{CH}_3)_2\text{CH}^+$] are about equal. An intense reagent ion may be at m/z 41 (C_3H_5^+).
Acetonitrile	Adjust the reagent gas pressure until: The ion at m/z 42 [CH_3CNH^+] is more than 5 times higher than the ion at m/z 41. The valley between these ions should reach a minimum at less than half the height of the m/z 41 ion. The m/z 54 ion [$\text{CH}_3\text{CHCNH}^+$] is present at 10 - 15% the height of m/z 42. NOTE: Too much acetonitrile in the trap can cause early filament failures.
d3-Acetonitrile	Adjust the reagent gas pressure until: The ion at m/z 46 [CD_3CND^+] is more than 5 times higher than the ion at m/z 44. The m/z 58 ion [$\text{CD}_3\text{CDCND}^+$] is present at 10 - 15% the height of m/z 46.
Methanol	The ion at m/z 33 [$(\text{CH}_3\text{OH})\text{H}^+$] dominates the spectrum. No peaks at m/z 32, and small peaks at m/z 31 and m/z 47.

The reagent gas pressure in the ion trap is about 1 to 2 x 10⁻⁵ Torr (about 1.3 to 2.6 x 10⁻³ Pa). The CI reagent molecules comprise about 1% of the gas pressure in the ion trap. Helium atoms from column flow are present at 100 times this pressure.

Setting CI Reagent Flow for External Mode

To set CI reagent gas flow for external mode:

1. Open the main valve of the methane (or isobutane) CI gas cylinder and set the second—stage regulator pressure to 20 psi.
2. Open **System Control**. Turn on the CI and Ion Gauge using the check boxes beneath the 240-MS icon. If the CI line has not been evacuated already, allow a few minutes for this process.
3. Adjust the CI valve so that the ion gauge reading is between 50 – 80 μTorr .

Setting CI Reagent Flow for Hybrid Mode

See the *240-MS Software Operation Manual* for information about setting CI reagent flow.

Liquid CI Inlet Option

Liquid CI is an effective tool for internal ionization CI. Because of the difficulty of getting sufficient CI reagent into the external source, do not use liquid CI for external CI use. After installing the liquid CI inlet, you can switch between pressurized CI Gas and liquid CI reagents without removing the assembly.

Switching from Gaseous to Liquid CI Reagent

1. Loosen the 2 screws that attach the CI Gas restrictor to the CI shutoff block in the back of the instrument. If a Liquid CI restrictor is not attached to the Liquid CI Inlet Assembly, loosen the two screws that attach the L bracket to the assembly.
2. Remove the 4 mL/min gas restrictor from the CI shutoff block.
3. Install the Liquid CI restrictor between the Liquid CI Inlet Assembly and the CI shutoff block.
 - For Internal Mode, use the 50 mL/min restrictor, part number 0393002401.
 - For hybrid Mode, use the 200 mL/min restrictor, part number 0393144001.
4. Tighten the screws.
5. Adjust CI reagent flow using the table in the “Ion Intensities for Standard CI Reagents” section on page 96.

Filling the Reservoir Bulb

1. Ensure that the CI valves are closed. Loosen the four screws retaining the liquid CI reservoir cover. The screws may remain in the block.
2. Remove the reservoir cover.
3. Gently pull the bulb down to remove it from the block. The O-ring and O-ring retainer may stay attached to the bulb.
4. Place the bulb into the reservoir cover, the reservoir cover serves as a stand.
5. Place the O-ring retainer over the bulb stem.
6. Place the O-ring over the bulb stem.
7. Use a 1 mL syringe to fill the bulb halfway with liquid CI reagent. This requires about 3 mL of reagent.
8. Pick up the reservoir cover with the bulb, retainer, and O-ring, and insert the bulb stem into the block.
9. Orient the cover so that the four screws engage the cover. Tighten the four screws, being careful not to strip the threads in the plastic cover.
10. After opening the CI valves from **Manual Control**, wait 2-3 minutes before turning on the filament or multiplier.

Switching from Liquid to Gaseous CI Reagent Operation

To switch from the Liquid CI Inlet to a pressurized CI Gas (such as methane):

NOTE: The CI Gas line can be reinstalled without removing the liquid CI inlet assembly.

1. Loosen the 2 screws attaching the liquid CI inlet restrictor to the back of the instrument.
2. Loosen the 2 screws attaching the L-bracket to the liquid CI inlet block.
3. Remove the liquid CI restrictor end that inserts into the back of the instrument and rotate the restrictor out of the way.
4. Install the 4 mL/min CI Gas restrictor, part number 393059701, between the gas supply and the CI shutoff block, below the L-bracket.
5. Tighten the screws.
6. Adjust CI reagent flow using the table in the "Ion Intensities for Standard CI Reagents" section on page 96.



Operating this instrument in a manner not specified in this manual, may result in injury.

Troubleshooting

Isolating a GC/MS Problem

Check the system in the following order to locate the problem.

1. Data System.
2. Gas Chromatograph.
3. MS.

Checking the Data System

See the 240-MS software release notes for relevant software troubleshooting procedures.

Checking the GC

Isolate a GC problem by running a test sample to check the carrier gas supply, chromatographic characteristics, and other parameters.

Troubleshoot injector and column problems by running the COLTEST mixture. Please see “Using the Column Test Mixture for Troubleshooting” on page 106 for more information.

Identify the source of a GC electronics problem by pressing the STATUS key and a CONTROL key such as, injector or column oven. If a fault is present, the message FAULTED appears. The 450-GC manual has the procedures for fixing GC faults.

Checking the MS

If you do not detect problems with the data system or GC, check the MS and the communication channel with the data system. Typical ion trap problems include lack of response (no spectra), low response, poor resolution, and mass mis-assignment.

Isolate problems such as, air leaks, burned-out filaments, electronic failures, and similar ion trap problems using the MS Workstation diagnostics tests. The 240-MS Service directory, included in the MS Workstation (C:\VarianWS\240-MS Service), has service methods for internal (240-MS Int Service.mth) and external (240-MS Ext Service.mth) modes. Use these methods in Manual Control to identify elevated air/water and hydrocarbon background levels, mass assignment, resolution problems, and other common problems.

To separate the GC from the MS to isolate an ion trap problem do the following:

1. Remove the column from the injector and plug the end with a septum to minimize the input of air.
2. Keep the column and transfer line at ambient temperature to prevent degradation of the stationary phase. The MS vacuum system does not need to be vented to complete this procedure.

To isolate the MS further, remove the column from the ion trap by doing the following:

1. Shut down the system.
2. Cap the transfer line with a no-hole ferrule.

Troubleshooting Spectra

Before you begin troubleshooting, do the following:

1. Bake out the 240-MS for at least 2 hours.
2. Run Diagnostics to determine if there are hardware problems.

If the problem is not resolved, use the following information to determine the cause of problems and resolve them.

No Spectrum Appears

If a spectrum does not appear when you click the ion trap icon in Manual Control, regardless of mass range, the possible problems include:

- Filament open (broken)
- Turbomolecular pump stopped
- RF needs adjustment.
- Instrument parameters are inappropriate.
- Trap assembled incorrectly.
- Electron multiplier malfunctioning.
- Electronics problem.
- Bake out insufficient.

Check for an Open Filament

Use diagnostics to determine if one or both filaments are open and replace the ones that are.

Check the Turbomolecular Pump

Use diagnostics to check the turbomolecular pump speed, if the pump speed is not $100 \pm 2\%$ check the cooling fans.

Check the RF Adjustment

Check if an RF adjustment is needed (especially after changing the ion trap temperature).

Check the Parameter Settings

Check the method parameters and adjust as needed. Ensure that the ionization storage level stores the selected ions in the trap.

If the spectrum returns, note which parameter(s) cause the problem. If no spectrum is present, and the trap was recently disassembled, check the trap assembly.

Check Ion Trap Assembly

Check that the trap components are assembled properly and reassemble the trap if needed.

Check Electron Multiplier

Check the electron multiplier and replace if necessary.

Loss of High Mass Peaks

- Check for an air leak, and fix if necessary.
- Check the RF ramp adjustment.
- Reduce trap temperature to 150 °C and wait for it to equilibrate. If the trap temperature is too high, the height of the 614 m/z ion may be shorter and the 502 m/z peak may disappear.
- Check the method parameters.

Missing a Section of the Spectrum

To resolve the loss high or low mass ions when the ions in the midrange of the spectrum are not affected:

- Adjust the RF, especially if the ion trap temperature was just changed.
- Adjust the ionization RF storage level; it may be incompatible with the scan range.
- Reduce the trap temperature; it may be too high. Reduce trap oven temperature to 150 °C, and wait for thermal equilibrium.

Poor Resolution with Acceptable Air and Water Levels

To resolve broad peaks:

- Check for a high column bleed and fix if necessary. High column bleeds allow too many ions in the trap.
- Check for contamination and clean the system if necessary. Ions from contamination result in too many ions being in the trap.
- Check and if necessary, adjust the supplemental waveform value.

Check the Ion Content of the Trap

With the trap on, note the TIC (total ion current) value. If the TIC value exceeds 20,000 counts in full-scan mode, reduce the number of stored ions.

Run Auto Tune

Run Auto Tune to reset the supplemental waveforms if problems are suspected.

Troubleshooting High Baseline at High Masses

If the baseline increases sharply between masses 400 and 1000, particles may be on the electrode surface.

Do the following to check for particulates on the electrodes:

1. In Manual Control, activate **C:\VarianWS\240-MS Service\240-MS (Int or Ext) Service.mth**.
2. In segment 2, turn the Trap on and the Ion Source off.
 - If the trap does not have particulates, the spiking above the baseline is not significant and the base amount is less than 10.
 - If there is spiking or if the base amount is greater than 10, the spiking is due to particulates. Clear the trap cavity and manifold area of particle matter using a compressed inert gas.

Checking for Leaks

Daily, before running samples, check the system for air and water leaks.

Leaks are a common problem with GC/MS. Air leaks may reduce sensitivity, cause problem with the tuning, and decrease resolution. Leaks may reduce the lifetime of the capillary column, filaments, turbomolecular pump, and electron multiplier.

Preparing for Leak Checking

To set up for leak checking:

1. Activate C:\VarianWS\240-MS Service\240-MS (Int or Ext) Service.mth.
2. In segment 1, turn on the trap.
3. Verify the column flow rate is 1.0 mL/min.
4. Set the GCMS temperatures as follows:
 - Trap temperature to 150 °C.
 - Transfer line temperature to 270 °C.
 - Manifold temperature to 35 °C.
 - Source temperature to 150 °C.
5. Set the column-oven to 100°C and injector to 100 and 230 °C.



If you hear a hissing sound, do not turn on the electron multiplier, RF voltage, or filament. The sound is probably due to a major air leak caused by extremely loose fittings, improperly seated O-rings, or open valves.

In the Diagnostics section, confirm that the turbomolecular pump is operating at 100% speed. If not, there may be a major air leak.

Diagnosing the System

- If the ratio of the height of the peak of mass 18 (H_2O^+) to mass 19 (H_3O^+) is about 10:1, there is just a little water vapor and the system is all right.
- If the ratio of peak height of mass 18 to mass 19 is less than 10:1 but greater than 5:1, bakeout the system.
- If the ratio of the peak height of mass 18 to mass 19 is much less than 10:1, the system contains excess water vapor. Bakeout the system.

No Significant Air Leaks with Little Water Vapor

- The peak at mass 18 (H_2O^+) may be the base (highest) peak depending on the amount of water vapor.
- The ratio of the peak height at mass 18 (H_2O^+) to mass 19 (H_3O^+) is greater than or equal to 10:1.
- The base amount value is significantly less than 500.
- The ratio of the peak height at mass 28 to mass 32 is about 4:1.

If there are no air or water leaks in your system, the values should be similar to these.

Base Amount	TIC	18:28 ratio	19:18 ratio	28 width
<500	<5000	$\approx 1:1$	10 to 15%	< 1 m/z

Characteristics of a Small Air Leak with Little Water Vapor

- The peak height at mass 28 is noticeably greater than that at mass 18.
- The base amount value has increased to greater than 500.
- The ratio of the peak height at mass 18 to 19 is greater than or equal to 10:1.

Characteristics of a Moderate Air Leak with Little Water Vapor

- The peak at mass 28 starts to overload.
- The Base Amount value may be several thousand counts.

Characteristics of a Large Air Leak with Little Water Vapor

- The peaks at masses 18, 19, 28 and 32 are broadened.
- As the leak increases, all peaks broaden and eventually become undifferentiated.

Fixing a Major Air Leak

The following are typical sources of large air leaks:

- Particles on or damage to the manifold flange O-ring seal.
- Particles on or damage to the transfer line O-ring seal.
- Loose transfer line nut.
- Poor O-ring sealing between the turbomolecular pump and the manifold.



Do not over tighten the fittings to prevent causing a larger leak.

If after following the preceding procedures you cannot eliminate the leak do the following:

1. Vent the system
2. Check the O-ring on the manifold and the O-ring on the transfer line for particles.
3. Wipe both O-rings with a low-lint tissue.

NOTE: If the turbo/manifold interface has leak or poor seal, the turbomolecular pump may not achieve 100% speed. Do not to operate the system at less than 100% speed.

Fixing a Minor Air Leak

Characteristics of a small to moderate air leak are:

- The peak at mass 28 is much larger than the peak at mass 18.
- The air leak may increase the water background, particularly in humid environments. Increased water vapor content may cause a 20% or greater increase in the 19:18 intensity ratio.

Checking GC Connections

NOTE: See the GC Maintenance Section for additional information.

To identify and fix a leak at connections between the capillary column and the injector or transfer line:

- Ensure that the ferrules are the correct size, for example, 0.4 mm for 0.25 mm ID columns, and 0.5 mm for 0.32 mm ID columns.
- Ensure that the ferrule on the transfer line is a graphite/Vespel® mixture. Most transfer line connection leaks happen on the high vacuum side, around the transfer line O-ring.
- Tighten each graphite/Vespel ferrule one-half turn beyond finger tight.
- Change the septum regularly as part of your routine GC preventive maintenance program to prevent septum leaks from loose injector nuts or septum overuse. Use good quality, low bleed septa to reduce the level of air bleeding into the system and background from the septum material.

- Replace the filters GC regularly. Saturated filters may increase the air/water background. Replace the filters whenever moisture or other background noise from the GC becomes problematic.

Troubleshooting Air Leaks Using Leak Detection Gas

Use a leak detection gas, such as difluoroethane (Dust-Off ®). Spraying the gas on a leak at the transfer line on the high vacuum side should produce an immediate response. If the leak is from the GC injector, the MS registers a response in about 90 seconds, due to the speed of the gas molecules traveling through the capillary column.

- If the leak is at the injector, fix it without venting the system. Wait for the GC zones to cool before beginning.
- If the leak is from a transfer line O-ring seal, shutdown the GC/MS system and vent the system first.

NOTE: Use the leak segment of the **C:\VarianWS\240-MS Service\240-MS (Int or Ext) Service.mth method** in **Manual Control**. If necessary, edit the mass range for the detection gas.

NOTE: Do not spray haphazardly around the fittings. Leak detection gases diffuse very rapidly from the fitting being testing toward the true leak. You could mistakenly identify the fitting being testing as the source of the leak.

To check for leaks:

1. Spray a fine stream of leak detection gas on the transfer line closest to the analyzer.
2. Monitor the display.
 - If a peak at the mass for the gas compound does not appear, the leak is not at the transfer line seal.
 - If a peak appears, the leak is at the transfer line seal. The surface of the transfer line O-ring may have particles. Shut down the system and check the O-ring.

Check the following gaskets and fittings for leaks and tighten the fittings and flanges. Pause between applications of the leak detection gas.

- Pneumatics manifolds.
- Vent valve fitting.
- Vacuum manifold flange.
- Transfer line nut.
- Injector nut.
- Septum nut.

Fixing High Water Levels

Sources of excess water vapor are:

- Insufficient bakeout time, allow at least two hours, after venting the system.
- Cleaning the Ion trap.
- Replacing the capillary column.
- Carrier gas tank.
- High atmospheric humidity.
- In external mode, spent helium getter.

The water background may be high after venting the system, and cleaning the trap. Baking out the system for at least two hours desorbs the water vapor from surfaces of the vacuum system and decreases the water level. Do not operate the system if the peaks for masses 18 and 19 are the same height.

After the system has baked out overnight and excess water is still present, water in the carrier gas tank, moisture collected in cold spots, or an air leak may be the cause.

Saturated filters on the GC may produce an increase in the air/water background. Replace the filters at regular intervals and when the GC background is noisy.

Using the Column Test Mixture for Troubleshooting

Most problems can be investigated using the GC/MS column test mixture, part number 392027300. A COLTEST method is in the C:\VarianWS\240-MS Service directory.

The following procedure describes the chromatographic conditions and the expected results when running the column test mixture with a 30-m vf5ms column (0.25 mm ID, 0.25 μ m film thickness).

Column Test Mixture

The column test mixture contains the following 12 compounds that range in concentration between 1 to 5 ng/ μ L.

Compound	Formula	Integer Mass	Quantification Mass
Decane	C ₁₀ H ₂₂	142	57
1-octanol	C ₈ H ₁₈ O	130	69
Undecane	C ₁₁ H ₂₄	156	71
Nonanal	C ₉ H ₁₈ O	142	67
2,6-dimethylphenol	C ₈ H ₁₀ O	122	107
2-ethylhexanoic acid	C ₈ H ₁₆ O ₂	144	73
2,6-dimethylaniline	C ₈ H ₁₁ N	121	106
Decanoic acid, methyl ester	C ₁₁ H ₂₂ O ₂	186	74

Compound	Formula	Integer Mass	Quantification Mass
Undecanoic acid, methyl ester	C ₁₂ H ₂₄ O ₂	200	87
Dicyclohexylamine	C ₁₂ H ₂₃ N	181	138
Dodecanoic acid, methyl ester	C ₁₃ H ₂₆ O ₂	214	143
Hexachlorobenzene	C ₆ Cl ₆	282	284

Method Parameters COLTEST Mixture

Flow Pressure Conditions

Use a constant flow of 1.0 mL/min.

1177 Injector Conditions

Use an isothermal temperature of 240 °C.

Set up the following split program:

Time	Split State 1	Split Ratio
initial	On	100
0.01	Off	Off
1.00	On	100

MS Temperature Conditions

1. Set the transfer line temperature to 250 °C.
2. Set the trap temperature to 150 °C.
3. Set the manifold temperature to 40 °C.
4. Set the source temperature to 150 °C if the 240-MS is in external mode.

Separate the mixture into the individual components to do library searches, quantification, and other manipulations.

Troubleshooting Chromatographic Problems

The column test mixture includes polar or active compounds such as 1-octanol, 2, 6-dimethylphenol, and 2, 6-dimethylaniline in hexane. Non-polar or inactive compounds include decane and dodecane at approximately 1 ppm in hexane. Analysis of the mixture provides information about solvent tailing, column efficiency, dead volume, active sites in the injector/column and other aspects. Use the following information to troubleshoot the chromatographic problems.

Solvent Tailing or Broadening Problems

Possible Cause	Solution
Injector dead volume.	Reinstall the column in the injector. Examine the column end under magnification to ensure a good cut and if necessary, cut it again.
Solvent flashing in hot injector.	Reduce the injection speed. If possible, reduce the injector temperature. If using sandwich injection, reduce the solvent plug to 0.5 μ L.
Plugged septum purge line.	Ensure the septum purge flow is 3.5-4.5 mL/min with 10-psi head pressure. If necessary, adjust the valve setting.
Injector not purged properly after splitless injection.	For a splitless injection, the vent flow should be at least 70 mL/min. The injector must switch to the split mode 30 to 90 sec after the injection.

Peak Tailing of Active Components

Possible Cause	Solution
Active sites in the injector insert or liner.	Replace or clean the injector insert. If necessary, silanize it.
Active sites or degraded phase in the column.	Remove the front 15 cm of the column and reinstall it. If the retention times change, or if cutting the column does not fix the problem, replace the column.

Low Response or Severe Tailing of High B P Compounds

Possible Cause	Solution
Injector temperature too low.	Increase the injector temperature.
High level of column bleed.	Condition the column at 30 °C below its maximum operating temperature. If conditioning does not help, switch to a high temperature column
Contaminated ion trap surfaces.	Clean the ion trap as describe in the Maintenance section.
Insufficient vaporization of higher boiling point components.	Increase the injector temperature and decrease the injection speed.
Trap temperature too low.	Increase the trap temperature in increments of 20 °C.

Leading Sample Peaks (Reverse Tailing)

Possible Cause	Solution
Overloaded column.	Dilute the sample, or do a split injection.
Degraded column stationary phase.	Change the column
Low carrier gas velocity.	Increase the carrier flow rate.

Poor Resolution

For example, the peaks may not be separated adequately, such as 2, 6-dimethylphenol and 2-ethylhexanoic acid in the column test mixture.

Possible Cause	Solution
Column temperature or program not optimized.	Modify the method to improve the separation. Slowing the column ramp rate may help.
Carrier gas flow not optimized.	Adjust the carrier gas linear velocity.
Column cannot separate species (Boiling points similar).	Use a column that is more polar.
Degraded column stationary phase.	Replace the column.

Peak Size not Reproducible

Possible Cause	Solution
Leaking or partially plugged syringe.	Ensure that the syringe is pulling up the sample. Ensure the nut is tight. Flush the syringe with solvent. Replace the syringe.
Leaking septum.	Replace the septum regularly and ensure that the septum nut is tight.
Improper installation of column in the injector, or a leak at the column inlet.	Check the installation of the column in the injector. Tighten the capillary column nut.
Sample absorbed by on the injector or column.	Change the injector insert. Remove the front 15 cm of the column, or replace the column.
Incomplete vaporization of sample in the injector.	Increase the injector temperature.
Injector splits too soon.	Confirm that the switch time is chromatographically optimized.

Peak Splitting (Particularly for Low Boilers)

Possible Cause	Solution
Sample flashing, which simulates two injections.	Lower the injection temperature.
Cracked column.	Cut off the cracked part and re-install the column.
Piece of septum stuck in the injector insert.	Replace the insert and septum.

Extra, Unexpected Peaks

Possible Cause	Solution
Septum bleed.	Use high-temperature, low-bleed septa. Check the septum purge flow.

Possible Cause	Solution
Impurities such as plasticizers, from sample vials.	Confirm by running a solvent blank with a new syringe. Use certified sample vials, and keep the samples refrigerated.
Impurities from carrier gas.	Install or replace the carrier gas filters.
Contaminated injector or GC pneumatics.	Remove the column from the injector. Bake it out at an elevated temperature, such as 350 °C, using a split vent flow of at least 20 mL/min.
Sample impurities.	Run a blank or standard to confirm.
Impurities extracted from the septum.	Switch to a new septum type, lower the injection temperature, or reduce the injection volume.
Impurities in syringe wash solvent.	Replace with high purity grade solvents.

Retention Time Differences Between Runs

Possible Cause	Solution
Unstable carrier gas flow.	Check the pneumatics for leaks. If necessary, replace the flow controller/regulator.
Column contamination or degradation	Condition or replace the column.
Injector leaks.	Replace the septum at regular intervals. Ensure the septum nut and capillary column nut are tight.



If the instrument is used in a manner not specified in this manual, it may not provide adequate safety.

Documents, Parts and Supplies

Other Documents

Among the documents on the MS Workstation CD are:

- 240-MS GC/MS Internal Ionization User's Guide (part number 395418400)
- 240-MS GC/MS External Ionization User's Guide (part number 395418500)
- 240-MS GC/MS Hybrid Ionization User's Guide (part number 395418600)
- MS Workstation Data Handling User's Guide (part number 395403800)
- 240-MS GC/MS Software Operation Manual (part number 395416800)
- 240-MS GC/MS Pre-installation Instructions (part number 395165000)

Parts and Supplies

Electronics

Part Number	Description
392530502	Assy, Chassis Fan, Analyzer Side
393141001	Assy, Transferline Heater
393141701	Assy , Cable, Power, Turbo Controller
393240301	Cable, Flat, EFC
393010204	Valve, Solenoid, 2-Way,BUNA-N W/Pins
393010601	Valve, Solenoid, 2-Way, Manifold Mount, Chemrez Seals, Rear CI
393010703	Valve, Solenoid, 3-Way , Manifold Mount, Vitron Seals
393132501	Assy, Flex Circuit, Heaters
393142001	Assy, Flex Circuit, Filament
393142501	Assembly, Adaptor, Int Ion Source
393143701	Assy, Cable, GC/4000MS Start

Pneumatics

Part Number	Description
393112491	Kit, Getter Replacement
393010001	CAL-GAS Needle Valve Parker
393264101	Helium EFC Assembly
393177201	Tube, CI IN, Pneumatic Blk/Needle Blk
393010101	CI-GAS Needle Valve Parker
393010702	CAL-GAS Valve, Solenoid, 3-way Manifold Mount, Vitron Seals
1778351200	Rivet, Solid, 1/8 X 3/4 in.

Analyzer Attached to Top Flange

Part Number	Description
393173901	Assy, Gate, Int Ion Source, Clean
393173801	Assy, BASE, Int Ion Source, Clean
393173701	Ring, Center, Int Ion Source
393173601	Plate, Retaining, Int Ion Source, Clean
393102091	Assy, Source, Internal Ionization
393053501	Spacer, Quartz Clean, Not Coated
393053502	Spacer, Quartz, Clean, Silco Coated
393101801	Assy, Trap
393161101	Isolator, Lens and Screw
393162201	Shield, Flex Circuit
393167101	Spacer, Magnet/Oven
393167201	Thumbscrew, Trap Oven
393102801	Trap Oven Half, Entrance
393102802	Trap Oven Half, Exit
393180801	Trap Oven Contact Spring
393102703	Assy, Trap Heater, External Source
393167701	Structure, Magnet, External, w/Magnet Holes
393167702	Structure, Magnet, External, No Magnet Holes
392017401	Assy, Filament disk, long
393167593	RF Electrode, Silco Stl Coated, Cleaned
393164493	Assy, Silco End Cap With Plug
393171201	Internal Transfer line Tip, Cleaned
393060501	Spring Gold Plated, Trap
393167001	Block, External Source
393167801	Magnet Holder
393167901	EI Volume
393168001	Gasket, Ext. Source
393168101	Retainer, Lens, Pins, External Source

Part Number	Description
393168301	Ring, Center, Trap
393168401	Assy, Lens 1
393168501	Assy, Lens 2
393168601	Assy, Lens 3
393161001	Assy, External Filament, Base w/Posts, Filament and Screws
393101701	Assy, External Source
393175801	Spring, External Source, CI Volume Retract
393176101	Disc, Magnet Clean
393171101	Tip, Transfer line, External
393160701	Holder, CI Volume
393160801	Volume, CI

Analyzer Attached to Manifold

Part Number	Description
393101201	Assy, Transfer line, 240-MS or 4000 MS
393164001	Clamp, Turbo
393168901	Assy, Vent Stem
393169101	Electrode, Conversion, Dynode
393175101	Multiplier, Channel, Model CEM 4755
393175301	Strap, High Voltage, Multiplier
393175701	Inlet, Helium, Manifold-Trap, Polyimide
393065501	Toggle Vent Level Assembly
2171993500	Spring, COMP, 0.210 in. OD, 0.026 in. DIA, 0.380L, SST
2170926600	Spring, COMP, 0.720 in. OD, 0.055 Wire, 3.0 L, SH.587
393172601	Elbow, Vacuum, 240-MS or 4000 MS

Chemical Ionization

Part Number	Description
393055501	CI Manifold
393179001	CI Block Frit Spacer
393055601	CI Plate
393177401	CI Gas Inlet, Manifold
1222110624	6-32 x 1½ in. Screw

Vacuum

Part Number	Description
393111991	Kit, Turbo Replacement, V301
8829953800	GP Oil Premium for the DS-102
2710100200	Oil Mist Cartridge Replacements (package of 2) for DS-102
2710100400	Scroll Pump Tip Seal

O-Rings

Part Number	Description
393010925	O-ring, 1.176 ID, 0.070 DIA, Viton, Clean
393010920	O-ring , 2-135, 1.925ID, 0.103 DIA, Viton (transfer line)
393010924	Viton O-ring , Top Flange PCB, 2-148, 7.484 ID, Quad
393010910	BUNA O-ring Clean 0.125
393010907	O-ring, 2-108, 0.237 ID, 0.103 DIA, Viton
393010927	O-ring, 1.049 ID, 0.103 IDA, Viton, Clean
393010928	0.145 ID Viton O-ring
393010911	0.239 ID Viton O-ring
390596009	0.348 OD O-ring

Miscellaneous/Other

Part Number	Description
2869397600	Union 1/16 SST for PID, ELCD (HALL)
2824707100	1/8 in. Brass Plug
391708450	1/8 in. Capillary Column Nut (connects the GC to the transferline)
393178301	Getter Mounting Clip
8829944000	High Vacuum Grease
391714250	Viton Ferrule
391715700	Viton Ferrule Washer
2211965000	Cable Tie
2884979200	Fitting, Screw Plug, 10-32 Brass NI Plated
2815892300	Polyurethane Tubing Clear
2899306000	1/8 in. Clutch Clamp
2815861100	Tubing, Poly, 1/8 in. X 1/16 in. Red
2815860300	Tubing poly, green
2884979300	Fitting, 10-32 THD, Male Tube, Brass NI
393180501	Tool, Internal Column Length
393060401	Alignment Tool Wrench, Saturn 2000
2990007700	Key, Hex, 6 mm
393141103	Cable, USB 2.0, 3 Meter Long
393169901	Holder Trap Service
393110391	Kit, Standard Accessory, 240-MS or 4000 MS

Standards and Test Samples

Part Number	Description
393112601	Evaluation Standard (Internal EI & CI) 2 pg/ μ L OFN, 5 pg/ μ L
393112702	Test Standard for External EI (5 pg/ μ L OFN)
392030500	Benzophenone External CI Sensitivity Sample (50 pg/ μ L)
393113001	Test Standard for External NCI (1 pg / μ L DFB)
392035300	(FC-43) Calibration Compound, Hazardous
392027300	GC/MS Column Test Mix, Hazardous

Varian Service

If you cannot resolve a problem, be ready to provide the following when you call a Varian Customer Representative:

- 240-MS serial number, which is inside the front panel.
- Description of the options that are installed
- Diagnostics test results.

If you are having problems with the gas chromatograph, you need to provide:

- GC model.
- Autosampler model, if any.
- Type of injector.
- Cryogenics.
- Information about your GC column, the manufacturer, bonded phase, film thickness, ID, length and other parameters.

If you are having problems with your computer or software, you need to provide:

- Computer manufacturer and model.
- Windows version.
- Mouse driver version.
- Printer manufacturer and model.
- Network configuration.
- Printouts of your Autoexec.bat and Config.sys files.
- MS Workstation software version.

In addition, observe the following guidelines when describing the problem to the Customer Support Representative:

- Tell the service representative which part of the software, System Control, Manual or Acquisition, for example, you were using when the problem occurred.

Appendix 1: Setup of Synchronization Signals for External Modules

Overview

The MS Workstation software coordinates the actions of external modules with the mass spectrometer. Modules not controlled by the MS Workstation software need synchronization signal cables. Ready, Start and Fault (Stop) functions are supported.

To record retention times accurately, the “Start Out” signal from the injection device must connect to the mass spectrometer “Start In” signal directly or indirectly through other instruments.

Synchronization Signals

The MS Workstation software coordinates the actions of external modules with the mass spectrometer. Modules not controlled by the MS Workstation software need synchronization signal cables. Ready, Start and Fault (Stop) functions are supported.

To record retention times accurately, the “Start Out” signal from the injection device must connect to the mass spectrometer “Start In” signal directly or indirectly through other instruments.

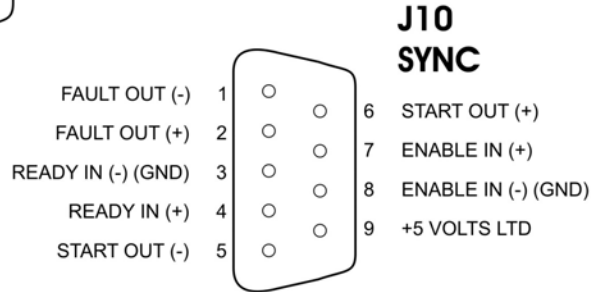
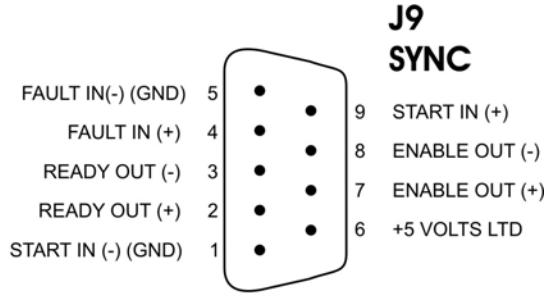
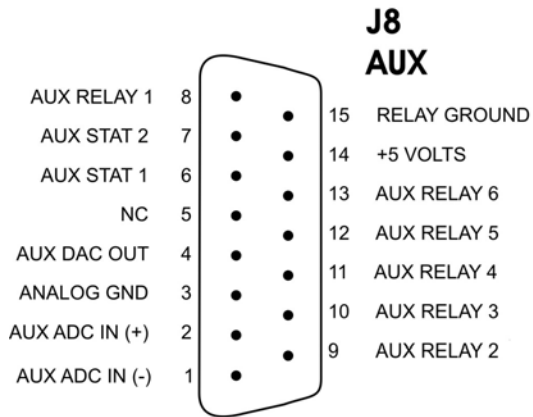

Input Schematic

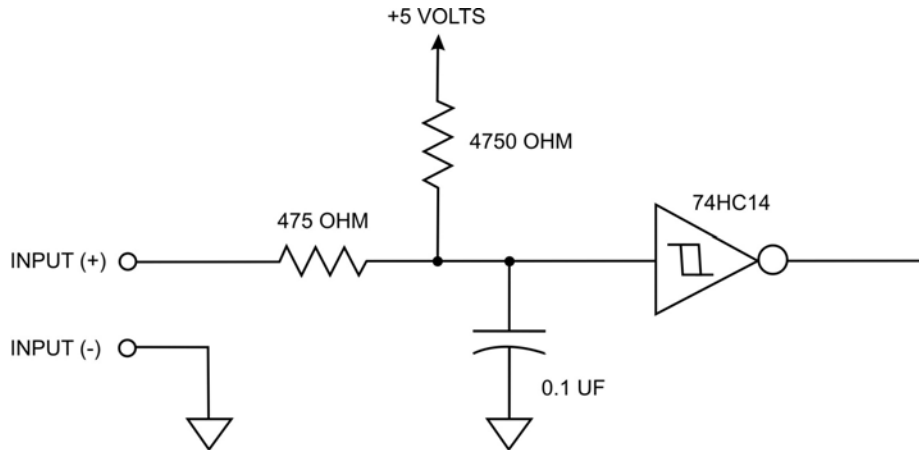

Synchronization Signal Output Schematic

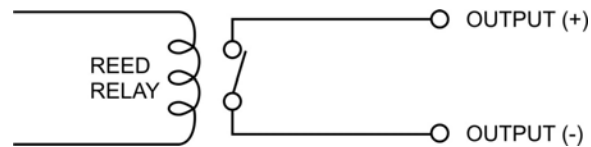

200 Milliamps Maximum Current

The maximum current through the relay contacts is 200 milliamps.

Synchronization Signal Characteristics

Ready In:	If the WaitForReadyIn checkbox is selected and the MS is ready (valid method/configuration, required options present, pre-acquisition verify is OK), Ready In triggers the MS to go from the NOT READY state to the READY state. Ready In is ignored in other states and modes. If the MS is at the top of the Ready chain, Ready In should be set appropriately by the user.
Ready Out:	The MS is in the READY state. This is set true in Acquisition Mode on transition to the READY state. It is set false (Not Ready) in Acquisition Mode on transition to any other state than READY (including RUNNING).
Start In:	Starts the active method in Acquisition Mode, if the instrument is in the READY state. The scan sequence command for the first method segment starts with this signal Start In. The Start In signal may be simulated by a Scan Control command.
Start Out: (1 sec pulse)	A 1 second pulse is generated by the hardware after signal from the MS software. The Scan Sequence command of the first method segment starts the method clock and the Controller generates a Start Out pulse.
Fault (Stop) In:	Informs the MS that a fault condition exists in another instrument in the group. If the MS is in Acquisition Mode and is not currently in an internal Fault state, the run will be aborted, a warning message will be put into the Message Log, the MS will go into the Not Ready state, and a Fault Out will be sent. After the MS goes into the Not Ready state, it transitions to the Ready state, pending the use and value of the Ready In (see discussion above). If the MS is in a Mode other than Acquisition and is not in an internal Fault state, the MS propagates the Fault Out signal.
Fault (Stop) Out: (1 sec pulse)	The MS sends a Fault Out, a 1 second pulse, from any Mode if it receives a Fault In and is not in a Fault state. The MS sends a Fault if it goes into an internal fault state in Acquisition Mode and that fault warrants aborting the run. If it goes into an internal Fault state, it requires a Reset to get out of this state. Upon Reset, it enters the Not Ready state and then a Ready In signal causes a transition to the Ready state.
Enable In:	Not used. "WaitForReadyIn" checkbox replaces this function.
Enable Out:	This activates Enable In on the next instrument if needed.