

LC/MS Purification Solutions
Automated Scale-up from Analytical to Preparative LC/MS

ASAPrep

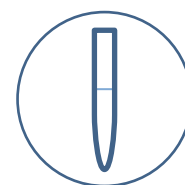
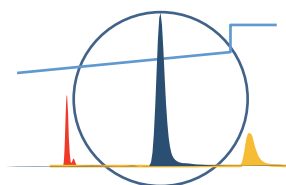
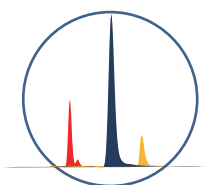
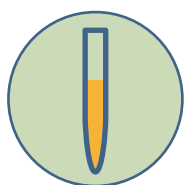

ASAPrep

A unique solution to automate and optimize compound purification and isolation

Compound isolation, purity analysis, and impurity analysis in pharmaceutical drug development presents increasing challenges to the industry as there is a clear need to enhance productivity and ensure compliance with evolving regulatory requirements. Such challenges are common to the development of new chemical entities, generic pharmaceutical manufacturing and contract research organizations. To help enhance productivity in compound purification and isolation Shimadzu has developed ASAPrep (Automated Scale-up from Analytical to Preparative), a unique solution to automate and optimize the purification process.

Open Solution Purification

Shimadzu Open Solution Purification software has been co-developed with pharmaceutical scientists to enable an automated approach to walk-up sample submission and optimized analytical to preparative scale up for compound purification and isolation. Using embedded data processing parameters, the software automatically checks the spectral integrity of the target compound for possible co-elution and also looks for closely eluting peaks. If the target compound is sufficiently resolved from other compounds in the sample it is submitted for a focused gradient preparative LC purification to optimize purity and recovery. Samples with co-elution or partial separation close to the retention space of the target compound are highlighted for data review and are not automatically submitted for purification.

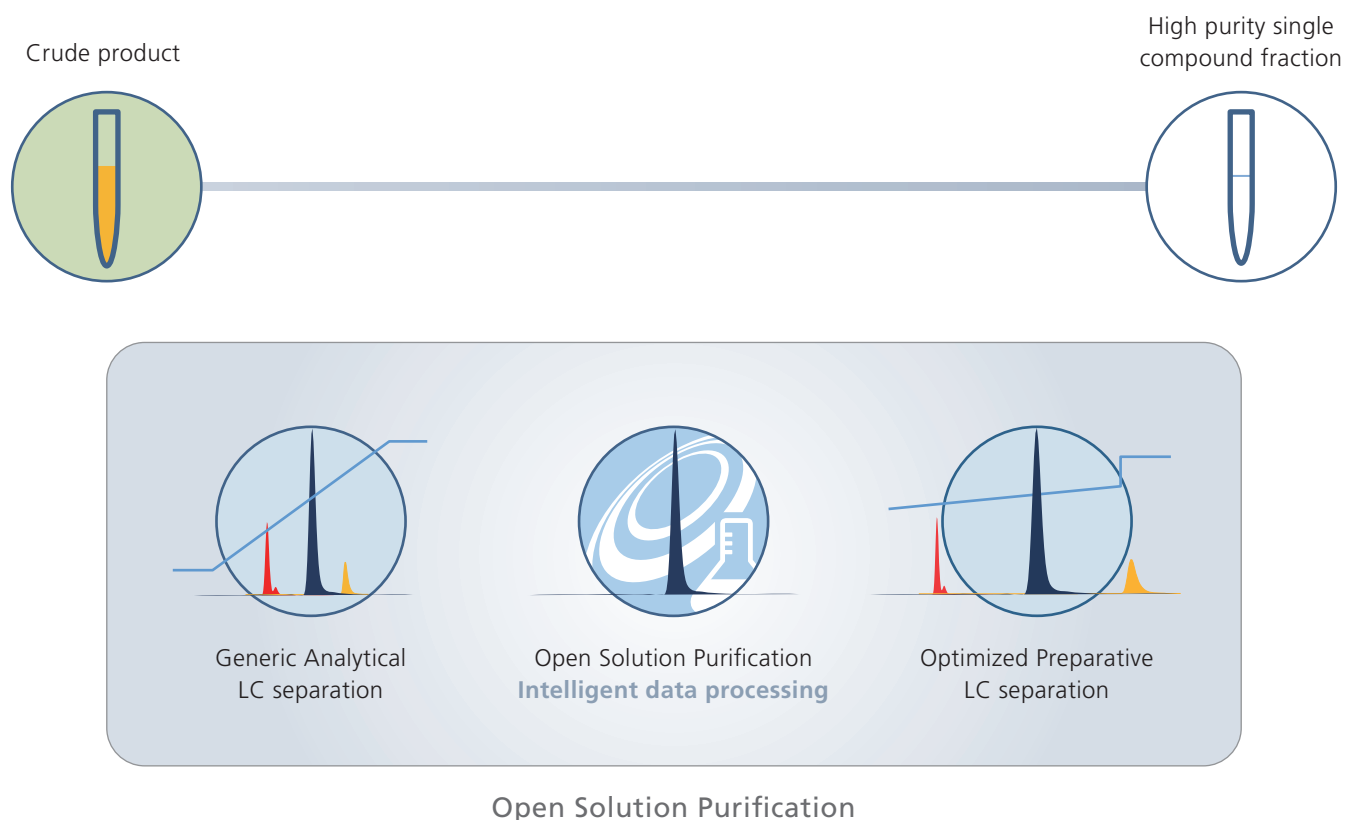

Accelerator technology for compound purification

Open Solution Purification software helps to streamline the analytical to preparative scale up process by making smart decisions about the data and the likely outcome. It is designed to deliver the highest purity and recovery of a collected preparative fraction.

Analytical LC

Method design



Analytical LC

Data processing

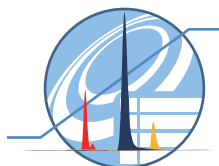

No co-elution has been detected and the analysis can go forward for preparative isolation.

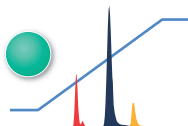

The target compound retention space is compromised by another compound. Review analysis. Submit for method development.

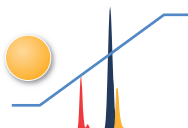

Target not found. Do not submit for preparative LC purification. Review analysis. Submit for method development.

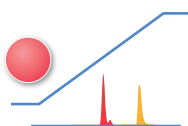

Preparative LC

Focused gradient profiles

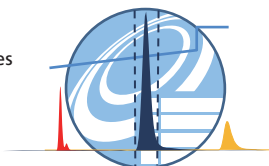

Advanced LC method options

- Support for pH switching
- Automated pre-run methods for mobile phase changes and column washing.

Target compound data processing

- The target compound retention time is confirmed using the LC/MS data stream.
- To verify the separation is appropriate for preparative isolation, the retention space close to the target compound is checked for closely eluting compounds (or even co-elution) using PDA and MS data streams.
- A spectral integrity algorithm verifies whether a single compound is present at the retention time of the target compound.

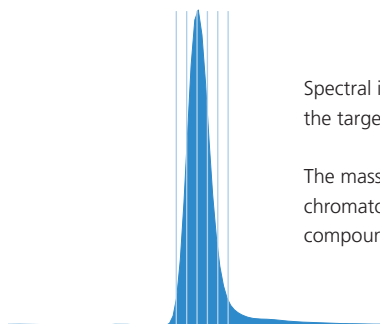

Spectral integrity algorithm automatically checks the target compound for co-eluting compounds.

The mass spectrum data is surveyed across the chromatographic peak to search for co-eluting compounds.

- If compounds are detected within a user defined retention window (and above a user defined threshold intensity) the sample is highlighted for checking.

Focused gradient generation

- For target compounds which do not have co-eluting or partial separation the focused gradient method is automatically applied.
- Focused gradients ensure the highest purity and recovery of the collected fraction.

Streamlining your workflow

Shimadzu's new purification software automates the process of purification and achieves the highest productivity. Embedded data processing parameters transform generic analytical LC separation data into fully optimized methods for preparative LC isolation meeting the demands of your laboratory. The system is pre-packaged with the L-Column ODS 2 technology and requires no method development allowing users to quickly generate high purity compound isolation. (Other column chemistries can also be supported).

ASAPrep workflows

Open Access software for compound purification

Step 1

Generic analytical LC screening

Using an open access workflow, analysts simply select a preconfigured analytical LC/PDA/MS method, submit their sample for analysis and review the results using Open Solution Purification software.

System managers can design the system to support multiple generic analytical LC methods including pH switching. The pH switching support includes options for column parking and extensive detox washing to help column management and extend column life time.

Step 2

Reviewing generic analytical LC and submitting samples for preparative LC isolation

Shimadzu's purification software automatically processes the generic analytical LC data and checks for co-elution or partial separation.

A color coded results table helps to accelerate decisions;

- Green – no co-elution has been detected and the analysis can go forward for preparative isolation
- Amber – data review - the target compound retention space is compromised by another compound(s)
- Red – data review - the target compound is not detected

Generic analytical LC method screening

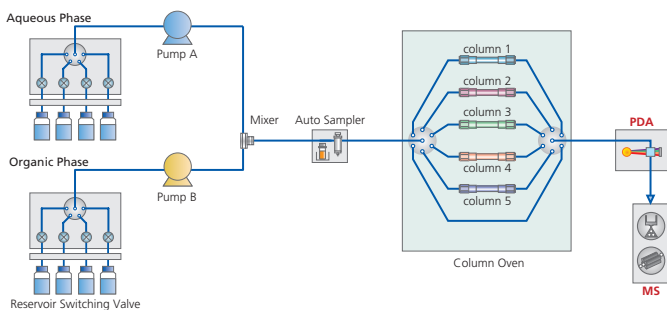

The software has also been designed to support pH switching methods. Dependent upon the chemical space being considered, it may be necessary to review the effects of pH on the target compound isolation. Analysts can review the analytical LC data and select the best separation for preparative LC isolation.

All column washes and pre-conditioning methods are built into the process to extend column life times and ensure stability in the LC separation. (In this example, the high pH separation resulted in less peak tailing compared to low pH method.)

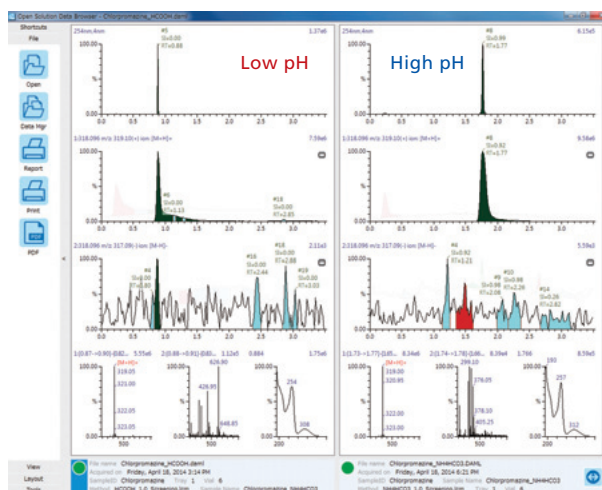
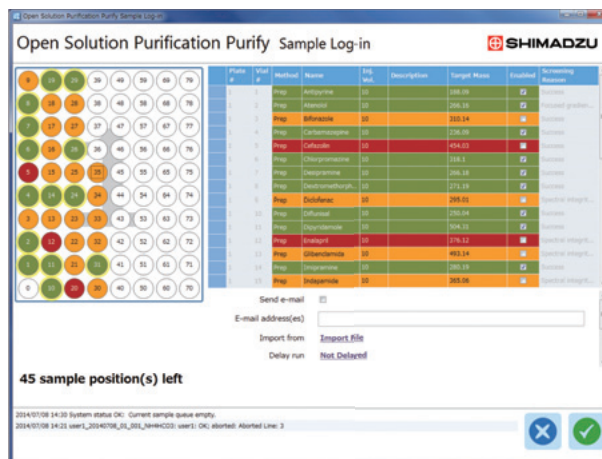
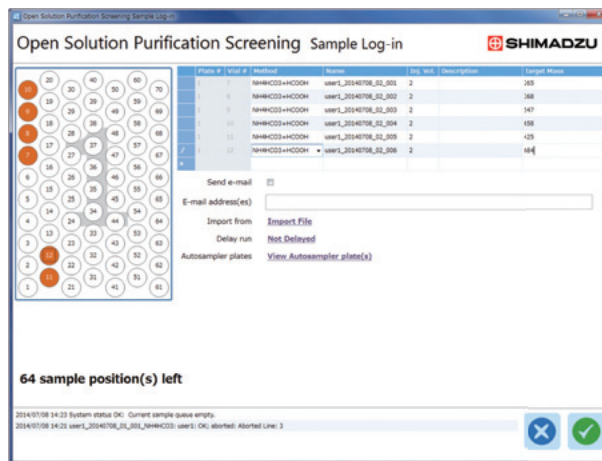

Generic analytical LC data review

The analytical LC results review allows analysts to see all chromatographic data including mass spectrum and PDA scan data. If the target compound has a spectral integrity score above a user defined threshold it is considered to be a single compound (a value close to 1 indicates a single compound is present over the retention window of the target compound). In the case of a partial LC separation, the spectral integrity score will be lower as the mass spectrum scan data across the target compound will not be consistent the spectral integrity score will be lower as the mass spectrum scan data across the target compound will not be consistent.

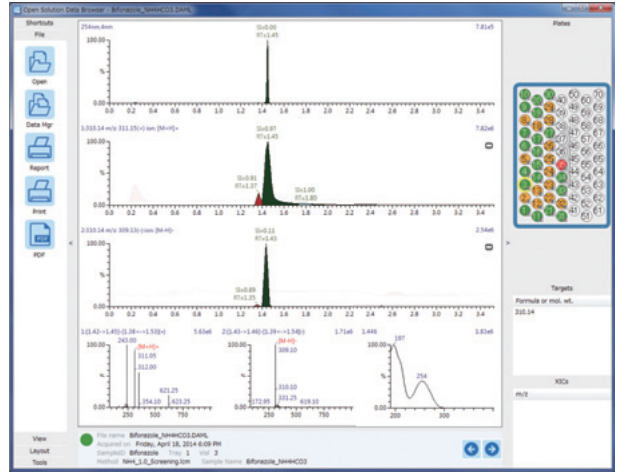

Reviewing preparative LC isolation

The fraction results browser allows analysts to simply track samples and fractions reviewing the LC/PDA/MS data for each collected fraction. Each data stream is shown for prep LC/PDA/MS analysis together with a color coded autosampler plate and fraction collector.

Color coded autosampler tray;

- Green – collected target compound purity is above a user defined threshold
- Amber – collected target compound purity does not meet all user defined thresholds and requires review
- Red – the fraction collected fails to meet the pre-defined criteria

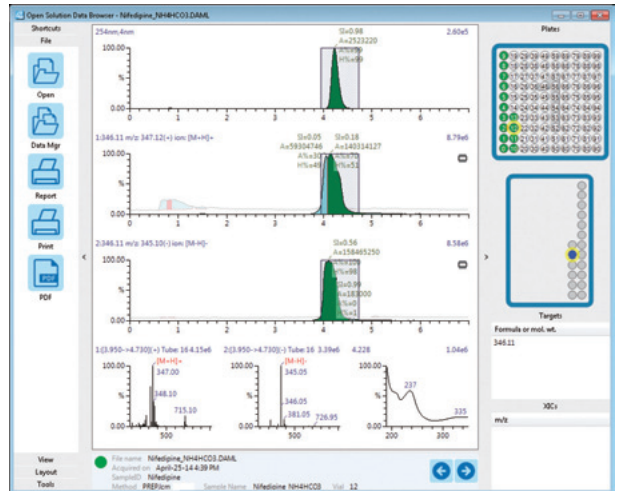

Report generation

A single click report can be generated from the fraction results browser showing the collected fractions and corresponding PDA/MS data.

A pdf report can also be generated as a single click operation.

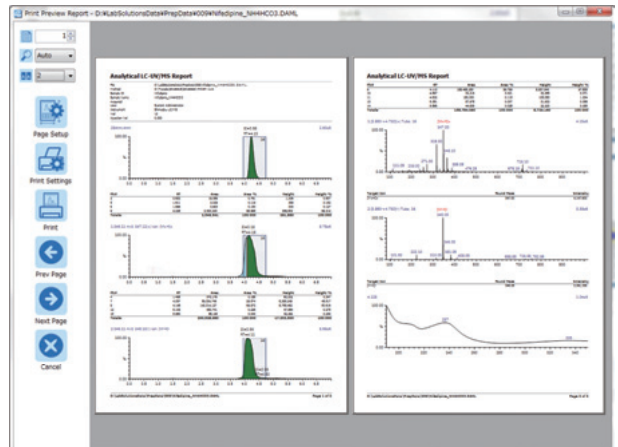

ASAPrep optimized purification

A unique algorithm for compound isolation and purification

ASAPrep initially verifies the retention time of the target compound using the analytical-scale LC data. The retention time of the target compound is then used by the ASAPrep algorithm to calculate the focused gradient profile for the preparative-scale separation to deliver the highest purity and recovery of the collected LC fractions.

In the example shown below, the ASAPrep algorithm has been used to change the retention time of each target compound in the preparative scale separation to elute at ~4.3 minutes.

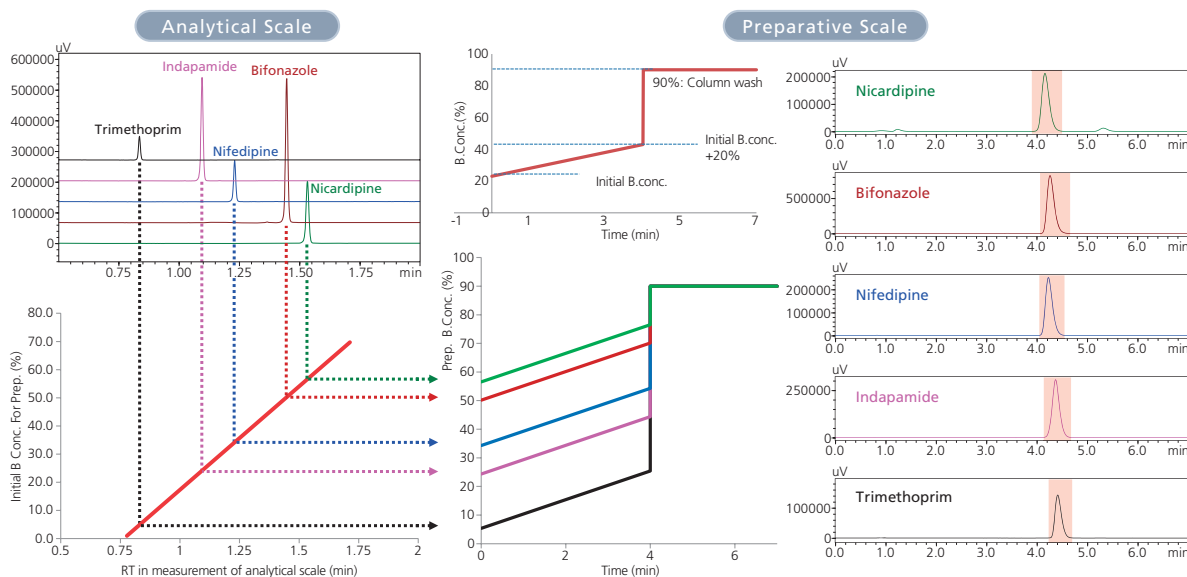

ASAPrep

Modifying the preparative scale focused gradient profile for each target compound to an elution time of ~4.3 minutes using L-Column ODS 2



Maximize purity and compound recovery on a single platform

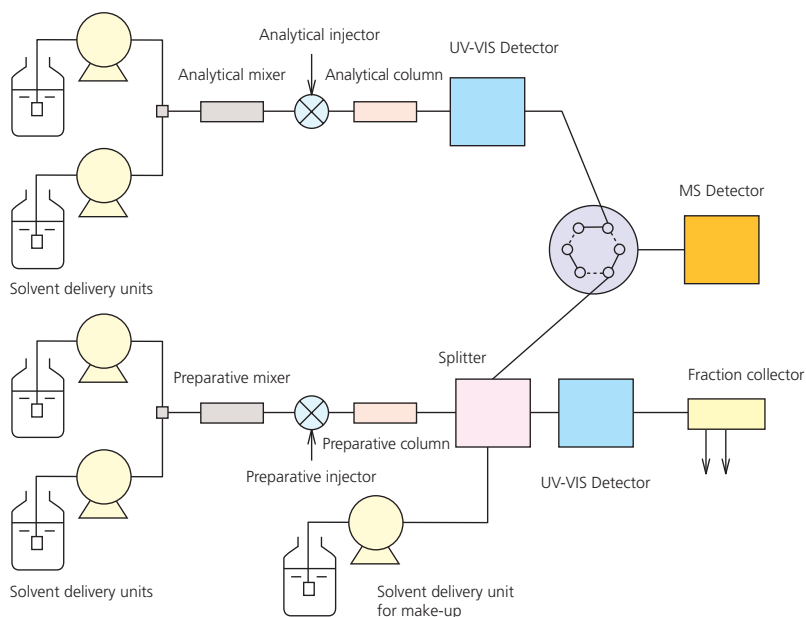

Generic system design which can be easily adapted to differing workflow and throughput needs

Prominence Preparative System

Shimadzu's purification platform is a modular solution to compound isolation working from analytical flow rates up to preparative flow rates of 100mL/minute at a back pressure of 42 MPa.

LC-20AT | High precision analytical to semi-preparative

- This solvent delivery unit supports precise analytical flow rates up to 10 mL/min.
- High-precision analysis is possible even in the semi-micro flow-rate range.



LC-6AD | Semi-preparative and recycling support

- Further extends the semi-preparative flow rate up to 20 mL/min.
- Supports solvent recycling.



LC-20AP | Large-Scale Preparative Fractionation

- Flow rates up to 150 mL/min (lower limit is 0.5 mL/min).
- Flexible configuration for purifications of micrograms to milligrams.



Low-pressure Gradient Preparative System



Analysis/Preparative System

Shimadzu's purification platforms

Open Solution Purification helps to accelerate analytical to preparative LC purification and isolation using conventional LC technologies. As an alternative technology, Shimadzu has also developed the Crude to Pure (C2P) platform. The C2P platform generates high purity dry powders, free from LC background and available within 3 hours from preparative LC fractions, regardless of fraction volume or water content.

Crude2Pure Automated Purification and Powderization System

Flexible System Configurations

Basic Crude2Pure System (Single Recovery System)

This is the simplest Crude2Pure system. The trapping system can process up to four samples and the recovery system two samples. (Expansion to a multi system is possible.)



Multi Recovery System Supporting Multi-sample Processing

This is recommended for multi-sample processing. The sample concentrated by the single trapping system is processed continuously by the multi recovery system. The recovery system accommodates up to 48 samples. The dedicated software, which is compatible with open access, allows setting of the trapping columns to the recovery system during operation.



Expansion from the Basic System (Multi Trapping / Recovery System)

If more throughput is required, the trapping system and the recovery system can be expanded to a multi system by adding rack changers, etc.



Shimadzu Corporation
www.shimadzu.com/an/

Company names, product/service names and logos used in this publication are trademarks and trade names of Shimadzu Corporation or its affiliates, whether or not they are used with trademark symbol "TM" or "®". Third-party trademarks and trade names may be used in this publication to refer to either the entities or their products/services. Shimadzu disclaims any proprietary interest in trademarks and trade names other than its own.

For Research Use Only. Not for use in diagnostic procedures. The contents of this publication are provided to you "as is" without warranty of any kind, and are subject to change without notice. Shimadzu does not assume any responsibility or liability for any damage, whether direct or indirect, relating to the use of this publication.