

# Agilent TRS100 Raman

Quantitative Pharmaceutical Analysis System

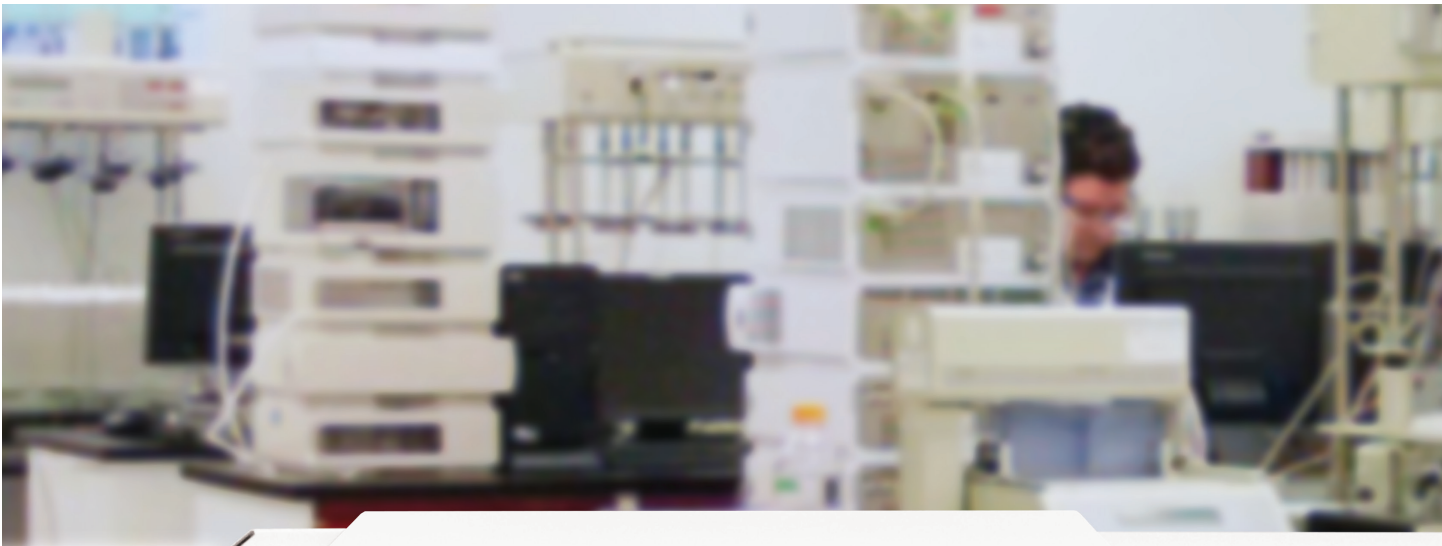



# Agilent TRS100 Raman – Streamlined Quality Control

Fast – Test hundreds of intact tablets or capsules in minutes

Simple – Quantify active pharmaceutical ingredients (APIs) and polymorphs in a single measurement

Low cost – No need for sample preparation, consumables, or skilled testing resource

Compliant – Regulatory approved methods for content uniformity, assay, and identification

## TRS100 for quality control and development

The Agilent TRS100 Raman system is ideal for fast assay of tablets, capsules, and other dosage forms. Transmission Raman technology from Agilent enables simple method-development and deployment in QC applications. It is easy to implement in analytical laboratories and production areas, and has regulatory approvals for content uniformity (CU), assay, and identification (ID) applications.

- High throughput
- Capsules and coatings
- Nondestructive
- No sample preparation

TRS100 measurements take seconds per sample and produce rich information for accurate quantitative analysis of intact samples. Routine applications include release testing, formulation development, and in-process control monitoring. Transmission Raman spectroscopy (TRS) is highly chemically specific and sensitive to low concentrations of APIs and excipients but insensitive to interference from water or moisture, tablet density, tablet coatings, or capsule shells.

## Alternative to wet chemistry

Using a single TRS100 system, an operator can complete CU, assay, and ID analyses—for batch release—in minutes, speeding up your QC workflow. There are no sample or standards preparation steps, no solvents or consumables, and batch tests can be finished as part of a normal working day. TRS100 system trays can hold up to 300 coated tablets or intact capsules, glass vials, powders, and more. Using TRS methods for CU, assay, and ID saves significant cost per batch. A TRS100 system can be deployed near a tablet press for near real-time QC results and release testing. Also, formulations with multiple APIs can be assayed in a single measurement for an even greater reduction in cost and analyst time.

### What is TRS?

Transmission Raman spectroscopy, unlike near-infrared spectroscopy (NIRS), is not an absorption technique. This means TRS can measure through most sizes of coated or uncoated tablets and colored gel capsules. Raman spectroscopy produces a feature-rich spectrum that can be used to separately quantify API, polymorph, and excipient components in one fast scan.

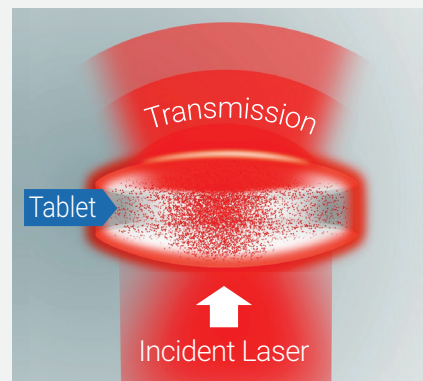

TRS quantification has:

- Low or no sensitivity to moisture, particle size and thickness variation
- Easy-to-interpret sharp spectral features
- Low limit of quantification
- Sensitivity to the sample bulk



# CU, Assay, ID, Polymorph Quantification, and Formulation Development

- Analyze up to 300 samples on a single tray
- Flexible sample presentation



Tablets

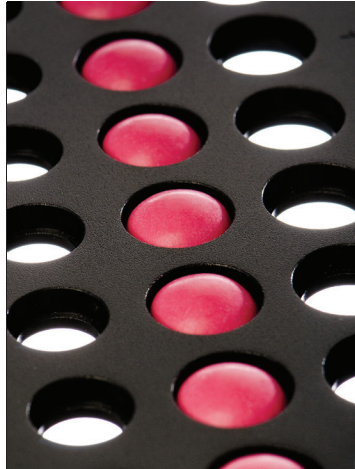

Coated tablets



Capsules



Powders



Liquids and gels

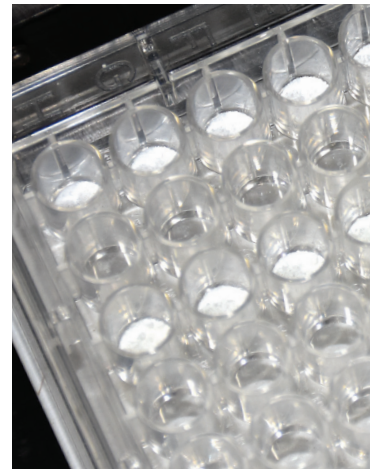

Microtiter plates

# Transform your End-Product Testing

Content uniformity, assay, and ID – faster, leaner, lower cost

TRS is a proven alternative to wet-chemistry analytical methods, needs no consumables or solvents and only basic analytical skills. A single TRS100 system CU test can often be completed in around 15 minutes, which enables a high throughput for QC testing and low resource usage by avoiding sample-preparation.

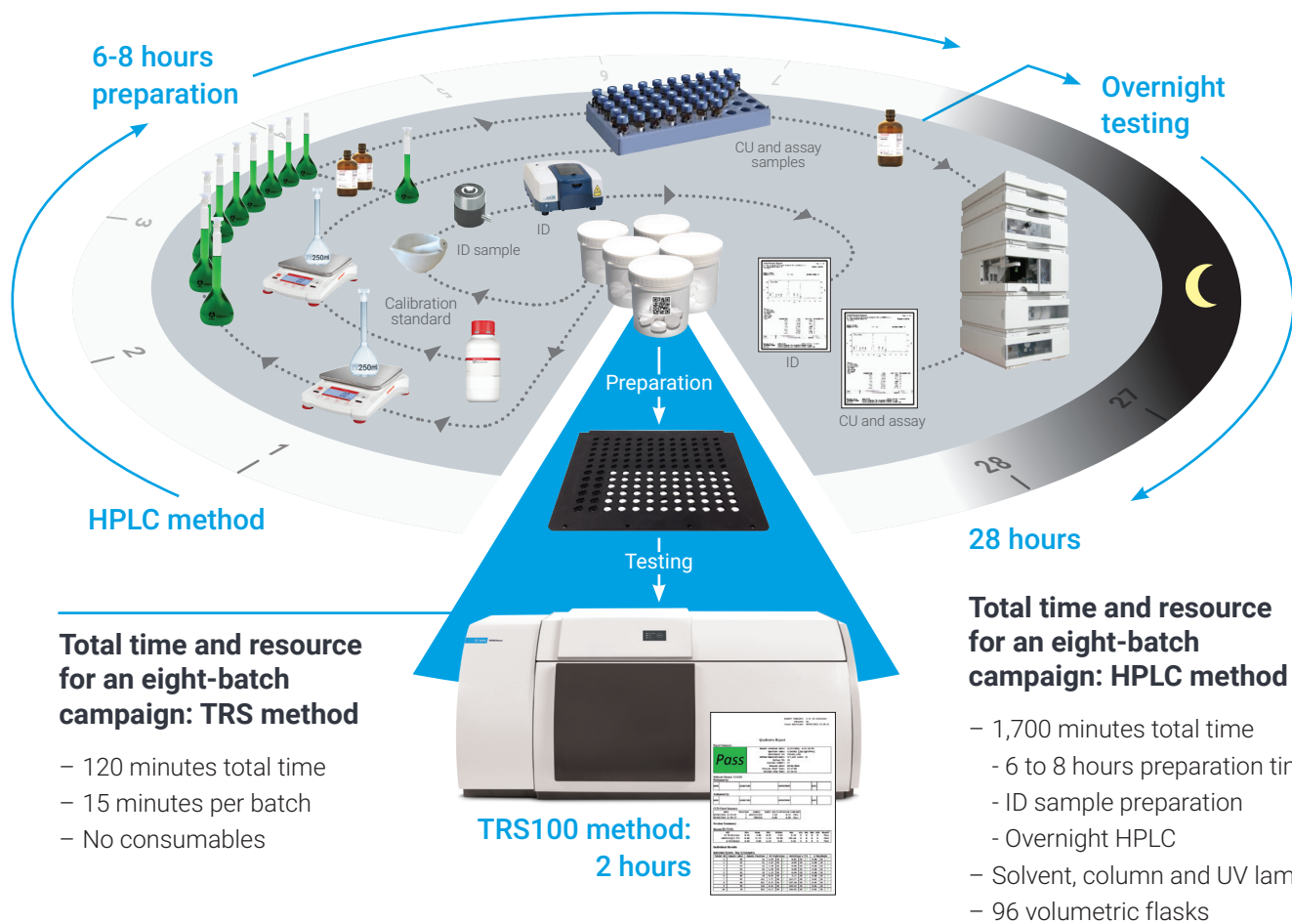

## High Throughput Testing - QC During Manufacture

The TRS100 system's sample-handling trays can hold up to 300 tablets, enabling high-throughput automated quantitative testing at the point of manufacture, whether effective in-process control monitoring or real-time release testing (RtRT).

- Large 'n' testing\*
- IPC monitoring
- Process validation
- Real-time release testing

\* Large 'n' testing extends CU testing to ≥100 tablets or capsules.  
See Ph. Eur Chapter 2.9.47, Demonstration of Uniformity of Dosage Units Using Large Sample Sizes.

## Method Development

Spectroscopic techniques, such as near-infrared spectroscopy, can be challenging for quantitative method development. TRS has several advantages over other techniques:

- Spectrally-rich features with high chemical specificity
- Fast method development using ICH and regulator-driven processes
- Development using a lean calibration design of experiments (DoE)

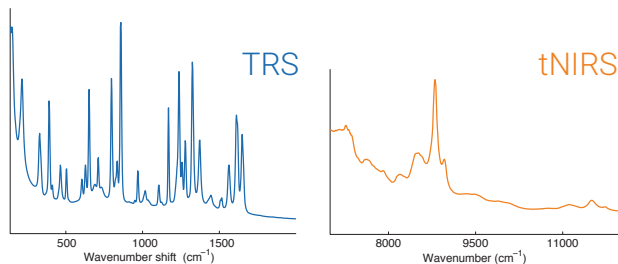

TRS spectrum with discrete API and excipient features, compared with transmission near-infrared spectroscopy (tNIRS) for the same three-API product.

## Measuring Low-Dose APIs and Polymorph Content

TRS is highly sensitive to APIs, which is ideal for quantification of low-dose drug products. Limits of detection (LOD) can be 0.1 to 1% w/w with limits of quantification (LOQ) in a similar range. TRS works well with low-dose API, polymorph, and salt-form analysis, and stability studies.

### Residual polymorphs in intact tablets

Most means of residual polymorph analysis quantification are destructive, slow, and expensive.

- Low-energy “phonon mode” region measures crystalline vibrational modes directly
- TRS has high sensitivity to polymorphs down to 0.1 to 1% – comparable with solid-state nuclear magnetic resonance (ssNMR) – in a fraction of the time
- Recrystallization may occur in hotspots throughout the tablet – TRS quantifies the intact dosage form, sampling the entire tablet volume, including any hotspots
- No sample preparation or risk of form conversion
- Low cost per test

\*Data from Kumar et al, American Pharmaceutical Review, 19(1), February 2016.

## Regulatory Approvals

CU, assay, and ID methods are approved for releasing commercial batches of products using the TRS100. CU and assay methods are developed as an alternative (secondary) method to the primary reference method – typically LC.

- Regulatory approvals achieved following International Committee on Harmonization (ICH)\* and spectroscopy guidance†
- Equivalency demonstrated with primary reference methods

For methods other than CU, assay, and ID, other regulatory guidance may apply.

\* ICH Q2 (R1), Q8, Q9, and Q10.

† FDA's Development and Submission of Near-Infrared Analytical Procedures Guidance for Industry, and EMA's Guidance on the Use of Near-Infrared Spectroscopy by the Pharmaceutical Industry and the Data Requirements for New Submissions and Variations.

Method* (w/w)	LOQ	Time per sample
Powder X-ray diffraction (pXRD)	2.5 to 10%	About 1 hour
Solid-state nuclear magnetic resonance (ssNMR)	<1%	Greater than 24 hours
Agilent TRS100	<1%	About 10 seconds

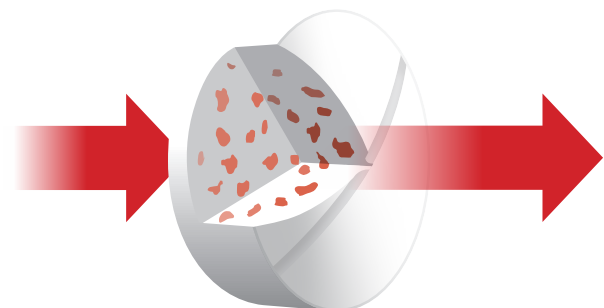

Polymorph hotspots of recrystallized API in a tablet – why TRS bulk-averaging works

# Quantitative Pharmaceutical Analysis

## TRS100 Compliance

Designed exclusively for quality control, analysis, and testing in pharmaceutical manufacturing, working to the industry's strict regulatory requirements. Integrated sample-handling for minimal operator interaction. Automatic calibration using NIST and ASTM-approved standards. Meets relevant USP, EP, and 21 CFR Part 11 requirements.

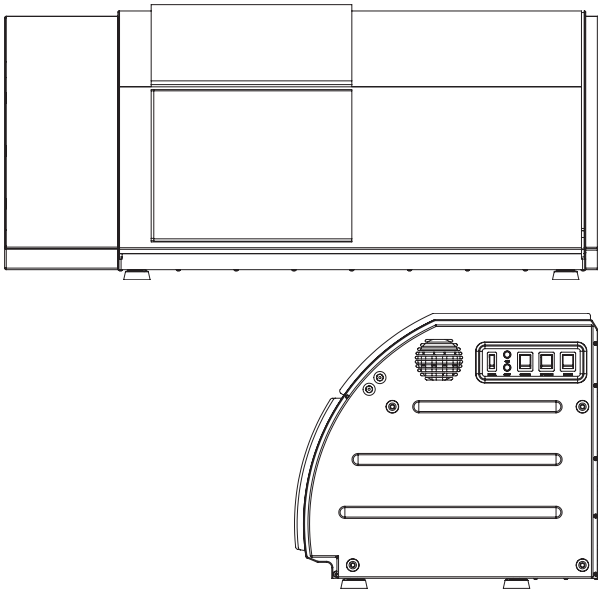

Specification	Description
Dimensions	Width 1124 mm (44.3 inches)
	Height 521 mm (20.5 inches)
	Depth 575 mm (22.6 inches)
Regulatory	21 CFR Part 11 compliant Meets relevant USP and EP guidance
Laser	Class 1 laser 830 nm
Power	90–264 VAC, 50–60 Hz
Software	Requires Windows 7 Pro or Windows 10 Supplied with Agilent ContentQC analysis and management software Integrated Eigenvector Solo chemometrics engine
Sample trays	Standard trays for common capsule and tablet sizes Customizable tray designs accommodate any sample Optional Beam Enhancer technology available for increased speed and sensitivity

Learn more

[www.agilent.com/chem/raman](http://www.agilent.com/chem/raman)

Find an Agilent customer center

[www.agilent.com/chem/contactus](http://www.agilent.com/chem/contactus)

U.S. and Canada

**1-800-227-9770**

[agilent\\_inquiries@agilent.com](mailto:agilent_inquiries@agilent.com)

Europe

[info\\_agilent@agilent.com](mailto:info_agilent@agilent.com)

Asia Pacific

[inquiry\\_lsca@agilent.com](mailto:inquiry_lsca@agilent.com)

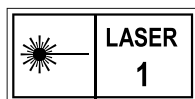

This information is subject to change without notice.

© Agilent Technologies, Inc. 2020  
Published in the USA, March 20, 2020  
5991-8864EN  
DE.690625