

Gas Chromatograph Mass Spectrometer

# GC/MS Off-Flavor Analyzer



# Analytical System for Reliably Identifying Odor-Causing Substances

Solving odor problems requires identifying the substances causing the odor. However, accurate identification requires relevant knowledge, such as knowing which types of compounds can cause odors, the odor quality, and threshold levels for sensing odors. This system combines a database of the major odor-causing substances and associated sensory information (odor characteristics and threshold levels for sensing odors) with a gas chromatograph mass spectrometer (GC-MS). It provides a total solution necessary for analyzing odors.

Odor Analysis Database

Compound Name (F)	Ref. Index 1	Comment (F)	threshold
Benzophenone	2470	Almond, Burnt sugar	10
2,4,6-Tribromophenol	2000	Iodoform	100
1-Tetradecanol	2168	Coconut	1000
gamma-Dodecalactone	2364	Sweet, Flower, Fruit	1
Dibenzyl disulfide	3022	Filter	1

Primary odor components      GC/MS analytical conditions      Sensory information

Optimal Analytical System



Disinfectant  
odor



Paint odor



Resin odor  
Moldy odor



## 1 Database of Expert Information for Odor Analysis

- All odor-causing substances identified from previous problems are registered.
- Accurate identification and easy quantitation are possible even without standard samples.
- Substances causing odors can be identified based on odor characteristics and odor threshold values.

## 2 Analytical System for Reliably Identifying Odor-Causing Substances

- Three different types of columns can be selected for detecting a wide variety of components with high sensitivity.
- MRM and SIM analysis can detect odor threshold concentration levels.
- Odors can be confirmed efficiently using the predicted retention time display function.

## 3 Application Solution-based System

- An optimal system, including pretreatment unit, can be configured.

This product was developed jointly with Daiwa Can Company.

# 1 Database of Expert Information for Odor Analysis

## Information Registered in Database

Compound Name (E)	Ret. Index 1 (InertCap Pure-W)	Quadratic Constan	Quadratic 1st	Quadratic 2nd	Comment (E) Odor Quality	threshold Odor Threshold
Benzophenone	2470	0.051311	0.471806	0.000501	Almond, Burnt sugar	10
2,4,6-Tribromophenol	2800	-0.00068	0.01852	0.0000413	Odorform	100
1-Tetradecanol	2158	0.111856	0.184791	0.000283	Coconut	1000
gamma-Dodecalactone	2364	0.001479	0.692803	0.000306	Sweet, Flower, Fruit	1
Dibenzyl disulfide	3022	-0.01548	2.23643	0.00077	Ether	1

Primary odor components

GC/MS analytical conditions

- Retention time information
- MS and calibration curve information

Sensory information of odor components

- Odor characteristics
- Odor threshold value

### All Odor-Causing Substances Identified from Previous Problems Are Registered.

The database includes information registered about all odor-causing substances identified from previous problems. Therefore, even if you don't know what types of compounds can cause odors, this database allows you to start analyzing them immediately.

### Accurate Identification and Easy Quantitation Are Possible Even Without Standard Samples.

Retention indices for each odor component are registered in the database. The AART function can be used to accurately identify components registered in the database by calculating their retention time using retention indices for substances with a wide range of boiling points. In addition, concentrations can be quantified easily based on the calibration curve information registered in the database.

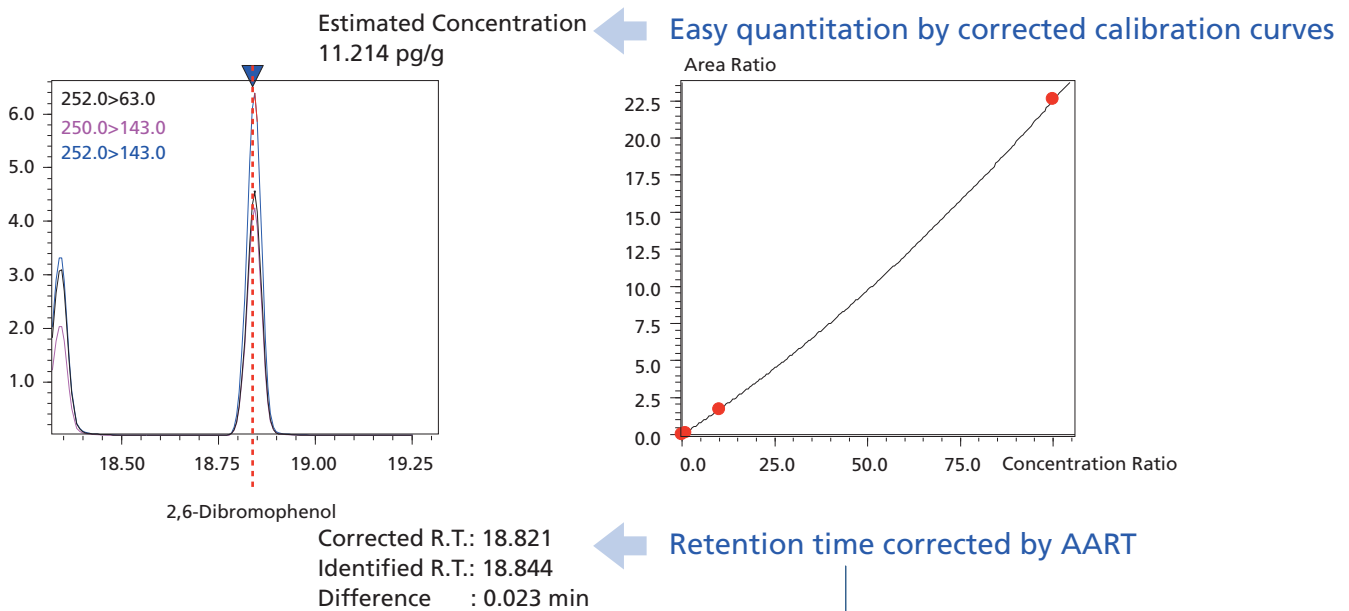

## Substances Causing Odors Can Be Identified Based on Odor Characteristics and Odor Threshold Values.

Sensory information about odor components (characteristics and threshold values) is registered in the database. Therefore, by comparing the concentration of components identified in chromatograms with the threshold values, the substances causing odors can be identified. Furthermore, odor components can also be identified by actually smelling them using a sniffer unit.

### Comparison of Concentration to Odor Threshold Values

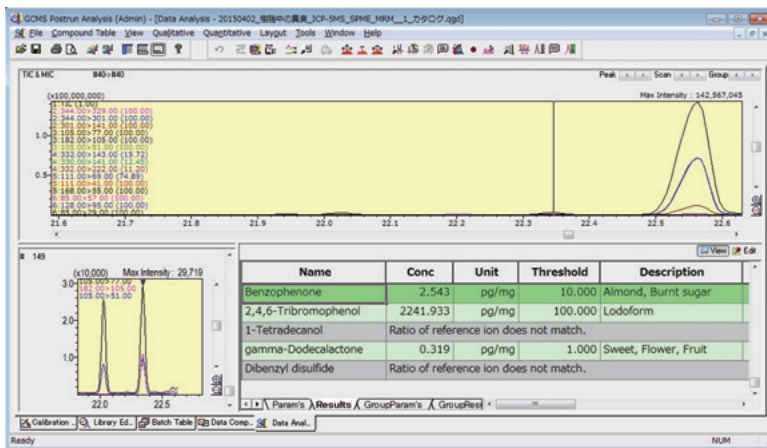

Name	Conc	Unit	Threshold	Description
Benzophenone	2.543	pg/mg	10.000	Almond, Burnt sugar
2,4,6-Tribromophenol	2241.933	pg/mg	100.000	Lodoform

#### Under Threshold Value

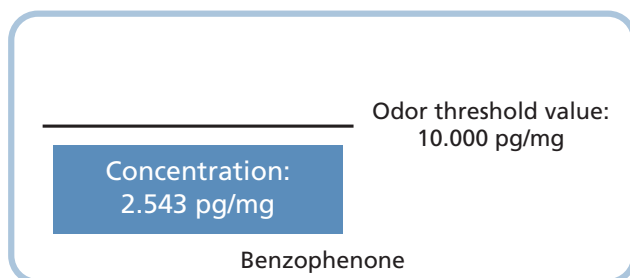

#### Over Threshold Value

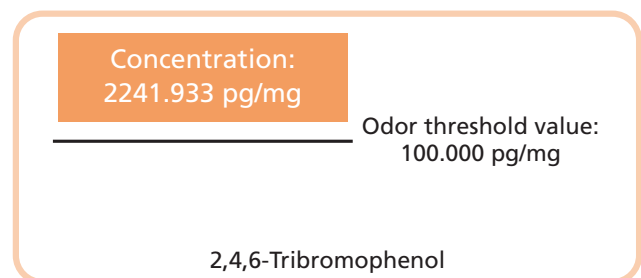

Odor components with concentrations higher than the corresponding threshold value can be identified as candidates for causing given odors.

Note: The concentration values calculated by the GC-MS off-flavor analyzer are estimates. If accurate concentration values are required, be sure to perform quantitative analysis using a method that involves creating a calibration curve.

### Confirming Odor Characteristics

Name	Conc	Unit	Threshold	Description
Benzophenone	2.543	pg/mg	10.000	Almond, Burnt sugar
2,4,6-Tribromophenol	2241.933	pg/mg	100.000	Lodoform

## 2 Analytical System for Reliably Identifying Odor-Causing Substances

### Process Flow Using the GC-MS Off-Flavor Analyzer

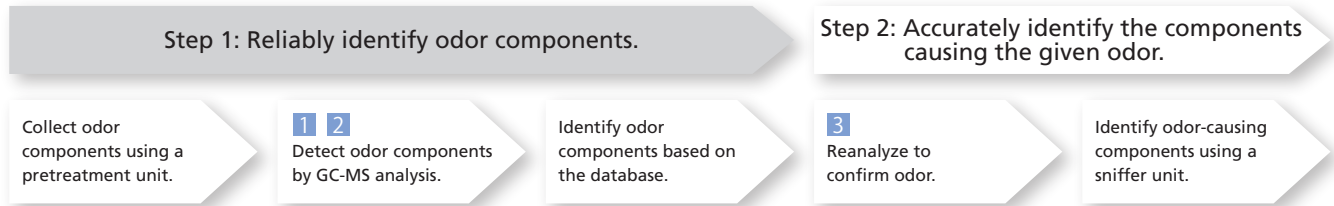

### 1 Three Different Types of Columns Can Be Selected for Detecting a Wide Variety of Components with High Sensitivity.

Three types of stationary liquid-phase columns are included, so that the optimum column can be selected based on the physical properties of the target components. A handbook provided with the system lists the detection limit for each registered component using the respective columns, which makes it easy to determine which column should be selected.

Example: Comparison of peak shapes obtained using columns with slight versus high polarity

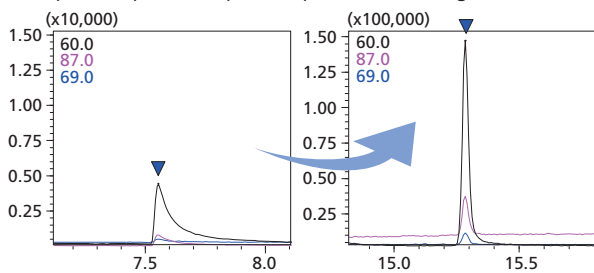

Mass Chromatograms of Isovaleric Acid  
(Left: InertCap™ 5Sil/MS, Right: InertCap™ Pure-WAX)

Using the slightly polar column to analyze highly acidic components, such as isovaleric acid, causes peak tailing, whereas using the highly polar column improves the peak shape, which enables measuring the component with high sensitivity.

Compatible Columns:  
InertCap 5MS/Sil (30 m, 0.32 mm I.D.,  $df = 0.5 \mu m$ )  
InertCap 17MS (30 m, 0.25 mm I.D.,  $df = 0.25 \mu m$ )  
InertCap Pure-WAX (30 m, 0.25 mm I.D.,  $df = 0.25 \mu m$ )

### Change Columns without Releasing the Vacuum

This minimizes system downtime due to changing columns.

Note: Available when using a splitter system that splits flows between detection by the MS and the sniffer unit.

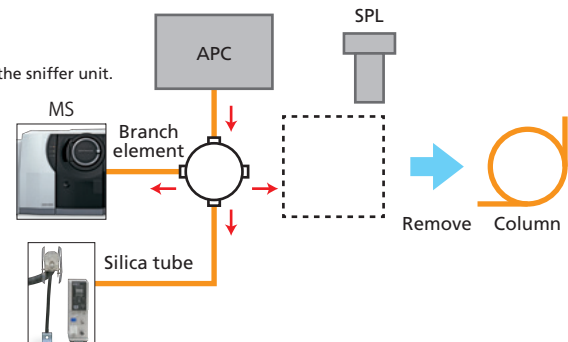

### 2 MRM and SIM Analysis Can Detect Odor Threshold Concentration Levels.

Since some odor components have a low odor threshold, low concentration levels need to be detected to identify the causative substances. High-sensitivity MRM/SIM analysis by GC-MS/MS can reliably detect even trace components near the odor threshold (a few pg/g).

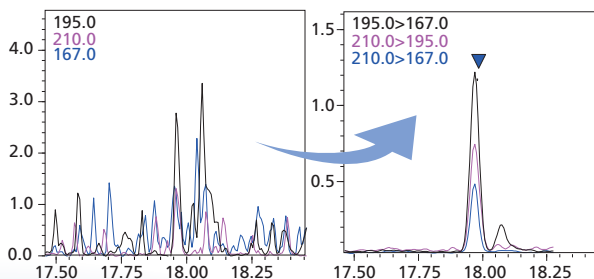

Mass Chromatograms of 2,4,6-Trichloroanisole  
(estimated concentration of 18.166 pg/g) in Food with an Odd Odor  
(Left: Scan analysis, Right: MRM analysis)

### 3 Odors Can Be Confirmed Efficiently Using Predicted Retention Time Display Function.

On systems with a sniffer unit, odor components identified from the database can be confirmed. The system includes a function that displays estimated retention times for detected components, so that they can be confirmed based on time.

Display Setting Window

Disp	Specific Comp	Compound Name	Ret.Time	Description	Threshold
<input checked="" type="checkbox"/>	<input checked="" type="checkbox"/>	2,4,6-Trichloroanisole	17.139	Earth, Musty	0.001

When a data file acquired in Step 1 is loaded, components that require particular attention are automatically marked with a check mark based on semi-quantitative results and odor threshold values for identified components.

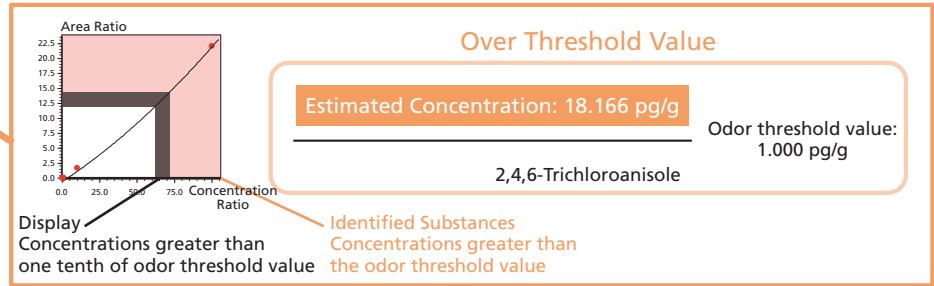

Data Acquisition Window

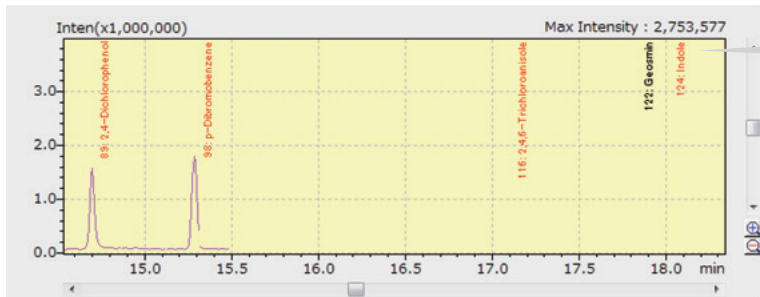

The name of components marked with a check mark are displayed near the corresponding retention time, so that in Step 2, you receive the appropriate timing for sniffing the odor.

### Confirming Odors in Matrices Prepared Using an FDL-1 Unit

The odor of detected components in a matrix can be confirmed by using an FDL-1 unit to successively add the odor in a standard sample to the odor in a matrix.



Note: This product is sold separately.

$$\text{Odor index} = 10 \log \frac{\text{Flow Rate of Matrix with Detectable Odor}}{\text{Flow Rate with Detectable Component Odor}}$$

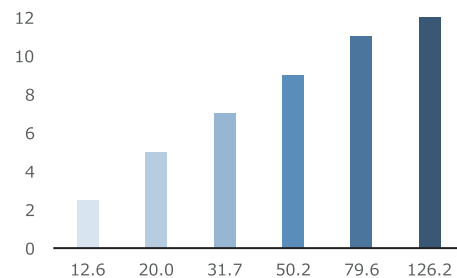

An FDL-1 unit can be used to confirm odor levels detectable in a matrix as the mixture ratio is successively changed in steps by adding different flow rates of odor components to a given flow of the matrix.

## 3 Application Solution-based System

### ■ An Optimal System, Including Pretreatment Unit, Can Be Configured.

The following is recommended as the optimal system.  
We offer total support for all systems.

AOC-6000 multifunctional autosampler :Supports injecting samples concentrated by SPME, injecting HS samples,  
or injecting liquid samples.

GCMS-TQ8040 NX, GCMS-TQ8040 :Enables detection of trace components by MRM analysis.

PHASER (GL Science B.V.) :If a candidate odor component is identified in a chromatogram,  
this unit can be used to confirm the odor.

OPTIC-4 (GL Sciences B.V.) :Supports injecting samples using a MonoTrap™.

Note 1: Sniffers other than the PHASER may be used in some cases. Contact your Shimadzu representative for details.

Note 2: The system does not support the OPTIC-4 LINEX function.



The following models may be selected depending on customer requirements.

GC/MS : GCMS-QP2020 NX, GCMS-QP2020, GCMS-QP2010 Ultra, GCMS-TQ8050 NX, GCMS-TQ8050

Autosampler : AOC-5000 Plus, AOC-20i/s

#### Cautions

1. Shimadzu makes no warranty regarding the accuracy of information included in the database or the usefulness of information obtained from using the database.
2. Be sure to perform tests using standard samples to confirm qualitative and quantitative information obtained using the given system.
3. To reliably identify registered substances using this database, measure samples using the instrument parameters specified in method files included with the product.

AOC, GCMS-TQ and GCMS-QP are trademarks of Shimadzu Corporation.  
InertCap and MonoTrap are trademarks of GL Sciences Inc.



Shimadzu Corporation

[www.shimadzu.com/an/](http://www.shimadzu.com/an/)

#### For Research Use Only. Not for use in diagnostic procedures.

This publication may contain references to products that are not available in your country. Please contact us to check the availability of these products in your country.

Company names, products/service names and logos used in this publication are trademarks and trade names of Shimadzu Corporation, its subsidiaries or its affiliates, whether or not they are used with trademark symbol "TM" or "®".

Third-party trademarks and trade names may be used in this publication to refer to either the entities or their products/services, whether or not they are used with trademark symbol "TM" or "®".

Shimadzu disclaims any proprietary interest in trademarks and trade names other than its own.

The contents of this publication are provided to you "as is" without warranty of any kind, and are subject to change without notice. Shimadzu does not assume any responsibility or liability for any damage, whether direct or indirect, relating to the use of this publication.